



OWNER'S MANUAL

Ateca



About this manual

This manual contains a description of the **equipment** supplied with the vehicle at the time this manual was published. Some of the units described herein will not be available until a later date or are only available in certain markets.

Because this is a general manual for the ATECA range, some of the equipment and functions that are described in this manual are not included in all types or variants of the model; they may vary or be modified depending on the technical requirements and on the market; this is in no way deceptive advertising.

The **illustrations** are intended as a general guide and may vary from the equipment fitted in your vehicle in some details.

The **steering indications** (left, right, forward, reverse) appearing in this manual refer to the normal driving movements of the vehicle except when otherwise indicated.

The **audiovisual material** only is intended to help users to understand certain car functionalities better. It does not replace the instruction manual. Please use the instruction manual to obtain more comprehensive information and indications.

✱ The **equipment marked with an asterisk*** is fitted as standard only in certain versions, and is only supplied as optional extras for some versions, or are only offered in certain countries.

® All **registered marks** are indicated with ®. Although the copyright symbol does not appear, it is a copyrighted mark.

» The section is continued on the following page.



Important warnings on a given page



Detailed contents on a given page



General information on a given page

SOS

Emergency information on a given page



Audiovisual material on a given page

WARNING

Texts preceded by this symbol contain information on safety. They warn you about possible dangers of accident or injury.

CAUTION

Texts with this symbol draw your attention to potential sources of damage to your vehicle.



For the sake of the environment

Texts preceded by this symbol contain relevant information concerning environmental protection.



Note

Texts preceded by this symbol contain additional information.

This manual is divided into six large parts, which are:

1. The essentials
2. Safety
3. Emergencies
4. Operation
5. Tips
6. Technical data

At the end of this manual, there is a detailed alphabetical index that will help you quickly find the information you require.

Foreword

This Instruction Manual and its corresponding supplements should be read carefully to familiarise yourself with your vehicle.

Besides the regular care and maintenance of the vehicle, its correct handling will help preserve its value.

For safety reasons, always note the information concerning accessories, modifications and part replacements.

If selling the vehicle, give all of the on-board documentation to the new owner, as it should be kept with the vehicle.

You can access the information in this manual using:

- Thematic table of contents that follows the manual's general chapter structure.
- Visual table of contents that uses graphics to indicate the pages containing "essential" information, which is detailed in the corresponding chapters.
- Alphabetical index with many terms and synonyms to help you find information.



WARNING

Read and always observe safety information concerning the passenger's front airbag »» page 79, Important information regarding the front passenger's airbag.



Related videos

	Always connected	»» Booklet Navigation system		Autonomous driving	»» page 216 »» page 197 »» page 225
	Smart solutions	»» page 247 »» page 232 »» page 220		Handsfree	»» page 123 »» page 116 »» page 257
	Illumination	»» page 131			

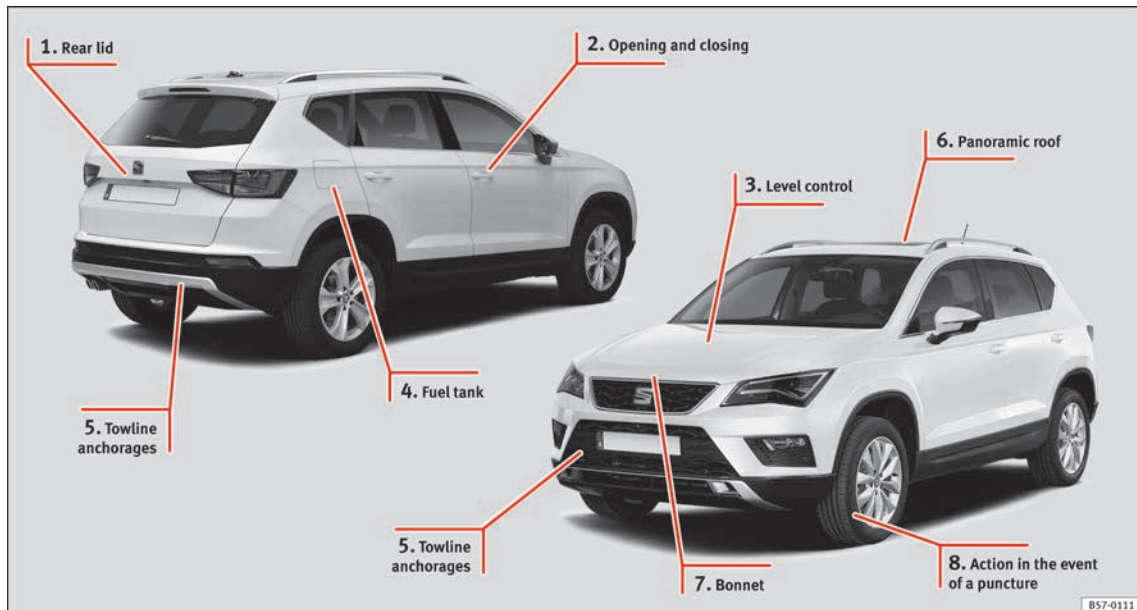
Table of Contents

The essentials	5	Correct position for passengers	63	Opening and closing	112
Exterior view	5	Pedal area	67	Central locking system	112
Exterior view	6	Seat belts	68	Anti-theft alarm system*	121
Interior view (left-hand drive)	7	Why wear a seat belt?	68	Rear lid (luggage compartment)	123
Interior view (right-hand drive)	8	How to properly adjust your seatbelt	71	Electric windows	126
How it works	9	Seat belt tensioners	72	Sunroof*	128
Unlocking and locking	9	Airbag system	73	Lights and visibility	131
Before driving	12	Brief introduction	73	Lights	131
Airbags	15	Airbag safety instructions	75	Visibility	138
Child seats	17	Deactivating airbags	77	Windscreen wiper and window wiper systems	139
Starting the vehicle	23	Transporting children safely	79	Mirror	141
Lights and visibility	23	Safety for children	79	Seats and head restraints	143
Easy Connect	26	Child seats	80	Adjusting the seats and headrests	143
Driver information system	29	Emergencies	83	Seat functions	144
Driving data	33	Self-help	83	Transport and practical equipment	147
Cruise control	36	Vehicle tool kit, anti-puncture kit*	83	Storage compartments	147
Warning lamps	38	Tyre repair	83	Storing objects	149
Gearbox lever	40	Manual unlocking/locking	85	Roof carrier	154
Air conditioning	42	Changing the windscreen wiper blades	85	Air conditioning	156
Fluid Level control	48	Tow-starting and towing	86	Heating, ventilation and cooling	156
Emergencies	51	Fuses and bulbs	90	Auxiliary heater (additional heater)	161
Fuses	51	Fuses	90	Driving	165
Bulbs	52	Changing bulbs	93	Start and stop the engine	165
Action in the event of a puncture	52	Change the front bulbs	94	Braking and parking	170
Changing a wheel	54	Change the rear bulbs	96	Manual gearbox	176
Snow chains	56	Operation	101	Automatic gearbox/DSG automatic gearbox*	177
Emergency towing of the vehicle	57	Controls and displays	101	Run-in and economical driving	184
How to jump start	58	General instrument panel	100	Engine management and exhaust gas purification system	186
Changing the wiper blades	60	Instruments and warning/control lamps	102	Driving tips	187
Safety	62	Instruments	102	Driver assistance systems	188
Safe driving	62	Control lamps	106	Start-Stop System*	188
Safety first!	62	Introduction to the Easy Connect system*	108	Hill Descent Control (HDC)	190
Advice about driving	62	System settings (CAR)*	108	Auto Hold Function	191
		Communications and multimedia	109	Cruise control system (CCS)*	193
		Steering wheel controls*	109	Speed limiter	194
		Multimedia	111		

Table of Contents

Adaptive Cruise Control ACC*	197	Brake fluid	287
Front Assist system including City emergency braking and pedestrian monitoring*	207	Windscreen washer reservoir	288
Lane Assist system*	213	Battery	289
Traffic Jam Assist	216	Wheels	291
Emergency Assist	218	Wheels and tyres	291
Blind spot detector (BSD) with parking assis- tance (RCTA)*	220	Tyre monitoring systems	295
SEAT Drive Profile*	225	Temporary spare wheel	298
Traffic sign detection system*	228	Winter service	299
Fatigue detection (break recommendation)* ..	231	Technical data	301
Park Assist*	232	Technical specifications	301
Parking System Plus (ParkPilot)*	239	Important	301
Parking aid (ParkPilot)*	244	Vehicle identification data	301
Area View*	247	Information on fuel consumption	302
Rear Assist (Rear View Camera)*	252	Trailer mode	303
Towing bracket device*	255	Wheels	303
Trailer mode	255	Engine data	304
Advice	265	Dimensions	307
Care and maintenance	265	Index	309
Accessories and modifications to the vehi- cle	265		
Care and cleaning	266		
Vehicle exterior care	266		
Caring for the vehicle interior	270		
Intelligent technology	273		
Electromechanical steering	273		
Four-wheel drive	273		
Power Management	274		
Checking and refilling levels	276		
Filling the tank	276		
Fuel	277		
Exhaust purification system for vehicles with diesel engines (AdBlue®)	279		
Engine compartment	282		
Engine oil	284		
Cooling system	286		

Exterior view

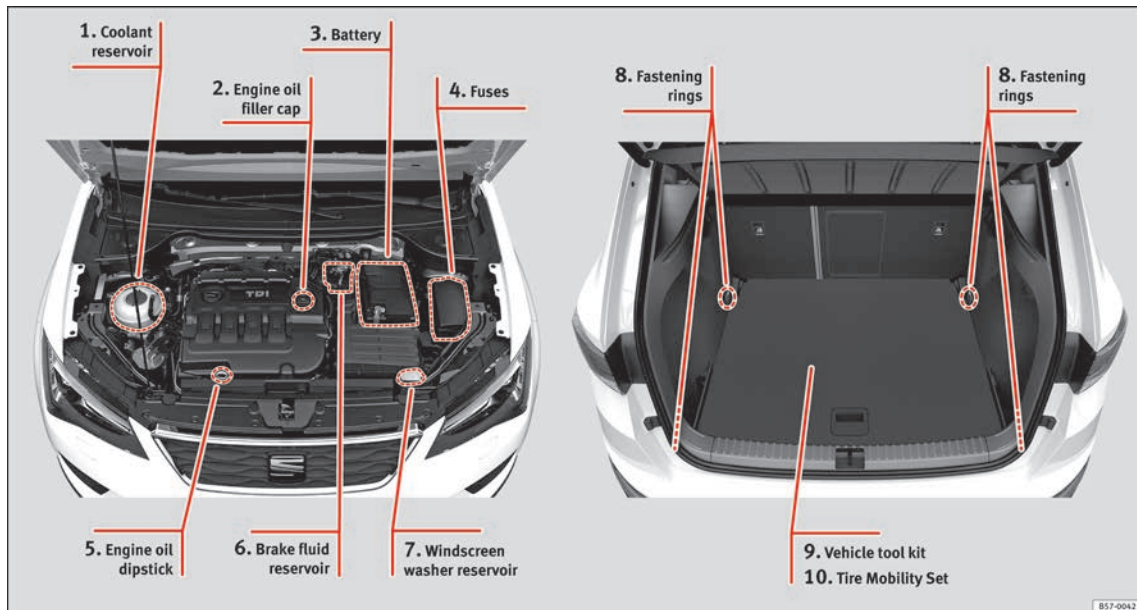


- ① » page 10
- ② » page 9
- ③ » page 48

- ④ » page 48
- ⑤ » page 57
- ⑥ » page 12

- ⑦ » page 11
- ⑧ » page 52

Exterior view



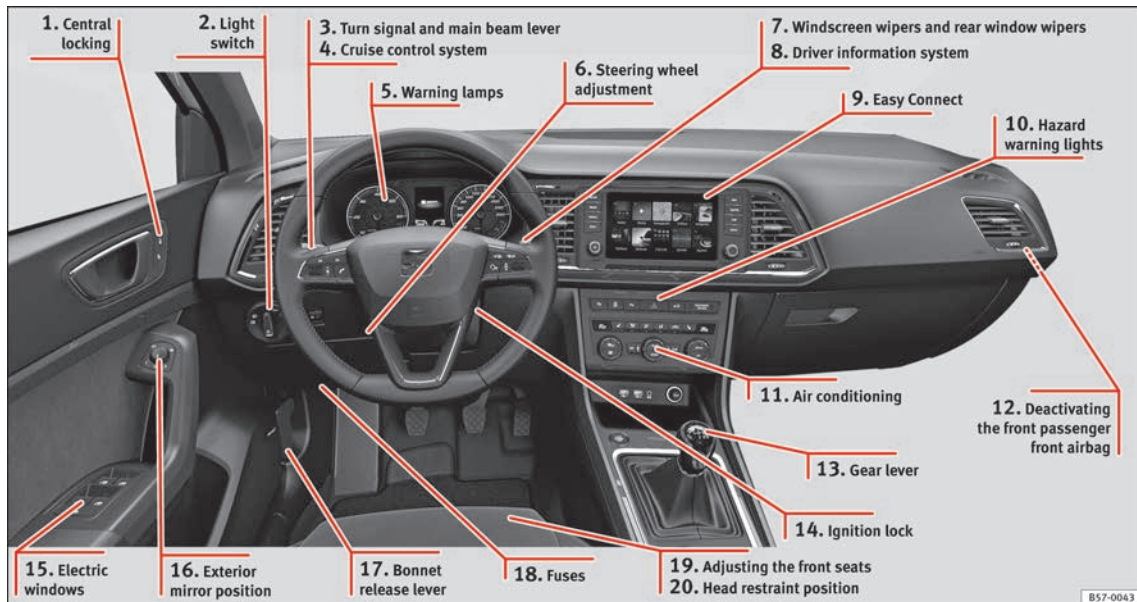
- ① » page 49
- ② » page 48
- ③ » page 50

- ④ » page 51
- ⑤ » page 48
- ⑥ » page 50

- ⑦ » page 50
- ⑧ » page 151

- ⑨ » page 54
- ⑩ » page 53

Interior view (left-hand drive)



- ① » page 9
- ② » page 23
- ③ » page 24
- ④ » page 36

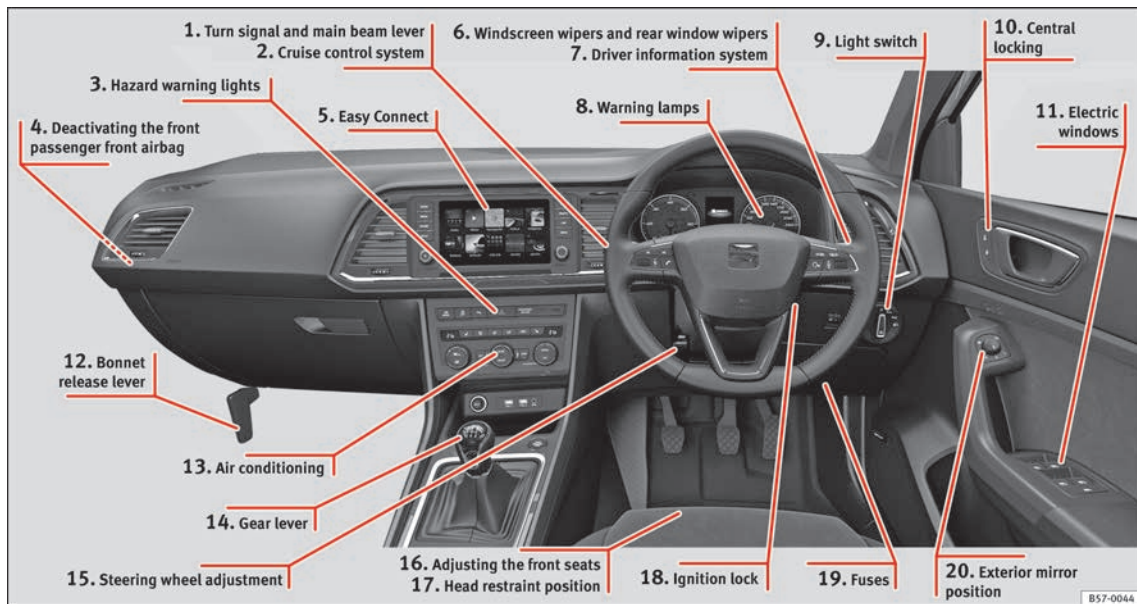
- ⑤ » page 38
- ⑥ » page 14
- ⑦ » page 25
- ⑧ » page 29

- ⑨ » page 26
- ⑩ » page 24
- ⑪ » page 42
- ⑫ » page 15

- ⑬ » page 40
- ⑭ » page 23
- ⑮ » page 12
- ⑯ » page 14

- ⑰ » page 11
- ⑱ » page 51
- ⑲ » page 12
- ⑳ » page 13

Interior view (right-hand drive)



B57-0044

- 1 » page 24
- 2 » page 36
- 3 » page 24
- 4 » page 15

- 5 » page 26
- 6 » page 25
- 7 » page 29
- 8 » page 38

- 9 » page 23
- 10 » page 9
- 11 » page 12
- 12 » page 11

- 13 » page 42
- 14 » page 40
- 15 » page 14
- 16 » page 12

- 17 » page 13
- 18 » page 23
- 19 » page 51
- 20 » page 14

How it works

Unlocking and locking

Doors







Fig. 1 Remote control key: buttons.





Fig. 2 Driver door: central locking switch.

Locking and unlocking the vehicle using the key

- Locking: press the  »» Fig. 1 button.
- Locking the vehicle without activating the anti-theft system: Press the  »» Fig. 1 button for a second time within 2 seconds.
- Unlocking: press the  »» Fig. 1 button.
- Unlocking the rear lid: Hold down the  »» Fig. 1 button for at least 1 second.

Locking and unlocking with the central locking switch

- Locking: press the  »» Fig. 2 button. None of the doors can be opened from the outside. The doors can be opened from the inside by pulling the inside door handle.
- Unlocking: press the  »» Fig. 2 button.



»»  in Description on page 112



»» page 112

SOS

»» page 9, »» page 10

Unlocking and locking the driver's door

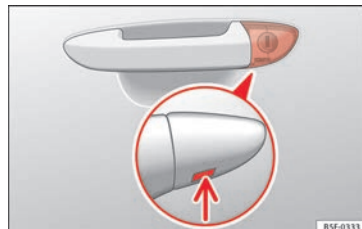





Fig. 3 Driver door lever: hidden lock cylinder.

If the central locking system should fail to operate, the driver door can still be locked and unlocked by turning the key in the lock.


As a general rule, when the driver door is locked manually all other doors are locked. When it is unlocked manually, only the driver door opens. Please observe the instructions relating to the anti-theft alarm system »»  page 112.

- Unfold the vehicle key blade »»  page 113.
- Insert the key blade into the lower opening in the cover on the driver door handle »» Fig. 3 (arrow) then remove the cover upwards.
- Insert the key blade into the lock cylinder to unlock or lock the vehicle. »»

Special Characteristics

- The anti-theft alarm will remain active when vehicles are unlocked. However, the alarm will not be triggered »»»  page 112.
- After the driver door is opened, you have 15 seconds to switch on the ignition. Once this time has elapsed, the alarm is triggered.
- Switch the ignition on. The electronic immobilizer recognises a valid vehicle key and deactivates the anti-theft alarm system.

Note

The anti-theft alarm is not activated when the vehicle is locked manually using the key shaft »»»  page 112.

Manual locking of the doors with no lock cylinder

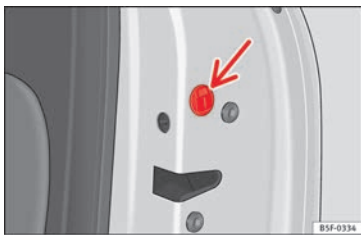


Fig. 4 Locking the door manually.

If the central locking system should fail to work at any time, doors with no lock cylinder will have to be locked separately.

A mechanical locking device (only visible when the door is open) is provided on the front passenger door.

- Pull the cap out of the opening.
- Insert the key in the inside slot and turn it to the right as far as it will go (if the door is on the right side) or to the left (if the door is on the left side).

Once the door has been closed it can no longer be opened from the outside. Pull the interior door handle once to unlock and open the door.

Rear lid

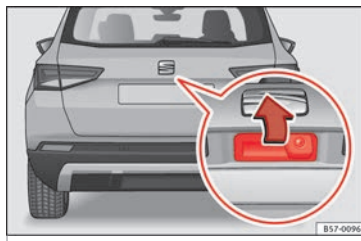




Fig. 5 Rear lid: handle



Fig. 6 Rear lid: button to close rear lid.

The rear lid opening system operates electrically. It is activated by exerting slight pressure on the handle »»» **Fig. 5**.

To lock/unlock, press the button  or button  »»» **Fig. 1** on the remote control key.

A warning appears on the instrument panel display if the rear lid is open or not properly closed.* An audible warning is also given if it is opened while the vehicle is moving faster than 6 km/h (4 mph)*.

Opening and closing

- Opening the rear lid: Exert slight pressure on the handle. The rear lid opens automatically.
- Closing the rear lid: hold one of the handles on the inner trim and close it by sliding down, or press the button on the rear lid* »»» **Fig. 6**.



» ⚠ in Tailgate automatic lock on page 125



» page 123

SOS

» page 11

Manual release of the rear lid

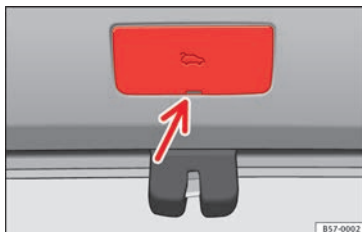


Fig. 7 Luggage compartment: access to manual release.



Fig. 8 Luggage compartment: emergency release.

The rear lid can be released from the inside.

- Remove the lid using the key blade as a lever » **Fig. 7**.
- To unlock the rear lid, press the lever in the direction of the arrow using the key blade » **Fig. 8**.

Bonnet

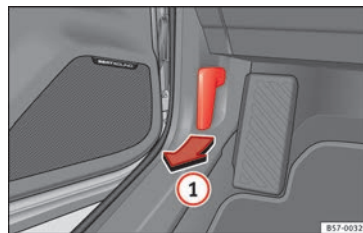


Fig. 9 Release lever in the driver's footwell area.



Fig. 10 Cam under the bonnet

- Opening the bonnet: Pull the lever under the dashboard » **Fig. 9 ①**.
- Lift up the bonnet. Press the release catch under the bonnet upwards » **Fig. 10 ②**. The arrester hook under the bonnet is released. »

• The bonnet can be opened. Release the bonnet stay and secure it in the fixture designed for this in the bonnet.



» » » ⚠ in Work in the engine compartment on page 283



» » » page 282

Electric windows*

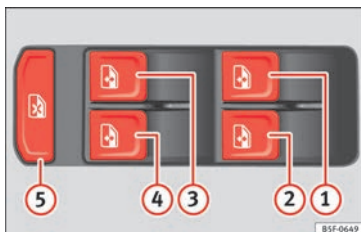


Fig. 11 Detail of the driver door: controls for the windows.

- Opening the window: Press the button.
- Closing the window: Pull the button.

Buttons on the driver door

- 1 Window on the front left door
- 2 Window on the front right door
- 3 Window on the rear left door

4 Window on the rear right door

5 Safety switch for deactivating the electric window buttons in the rear doors.



» » » ⚠ in Electric opening and closing of windows on page 126



» » » page 126

Panoramic roof*

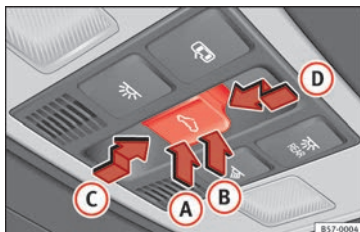


Fig. 12 On the interior roof lining: sunroof button.

- Opening: press button **C** backwards.
- Closing: press button **D** forwards.
- To tilt open: press the rear part of button **B**.
- Lowering: press the front part of button **A**.



» » » ⚠ in Introduction on page 128



» » » page 128

Before driving

Manually adjusting the front seats

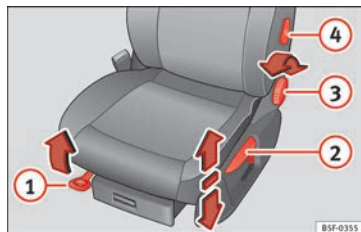


Fig. 13 Front seats: manual seat adjustment.

- 1 Forward/back: pull the lever and move the seat forwards or backwards.
- 2 Raising/lowering: pull/push the lever.
- 3 Tilting the backrest: turn the hand wheel.
- 4 Lumbar support: Press the button in the corresponding position.



» » » ⚠ in Manual adjustment of seats on page 143

Electric adjustment of the driver's seat*

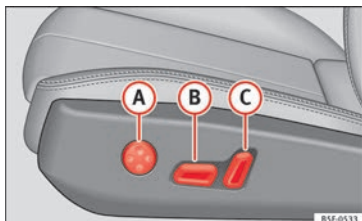


Fig. 14 Driver's seat: electric seat adjustment.

- A** Adjusting the lumbar support: press the button according to the desired position.
- B** Seat up/down: Press the button up/down. To adjust the front of the seat cushion, press the front of the button up/down. To adjust the rear of the seat cushion, press the rear of the button up/down.
Seat forwards/backwards: press the button forwards/backwards.
- C** Backrest further upright/further reclined: press the button forwards/backwards.



» » ⚠ in Electric driver's seat adjustment* on page 143

Adjusting the head restraints

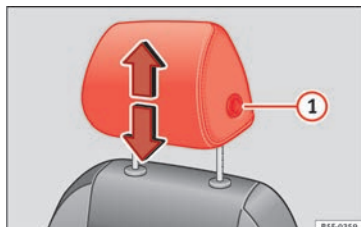


Fig. 15 Front seat: adjustment of the head restraint.

- Grab the sides of the head restraints with both hands and push upwards to the desired position. To lower it, repeat the same action, pressing the ① button on the side.



» » ⚠ in Correct adjustment of front head restraints on page 66



» » page 66, » » page 143

Adjustment of the seat belt

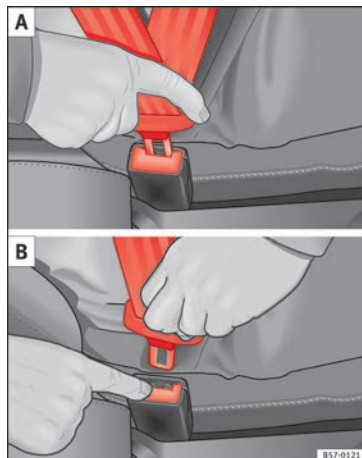


Fig. 16 Positioning and removing the seat belt buckle.



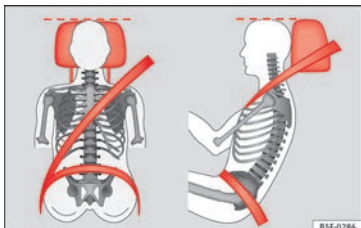


Fig. 17 Correct seat belt and head restraint positions, viewed from front and the side.

To adjust the seat belt around your shoulders, adjust the height of the seats.

The shoulder part of the seat belt should be well centred over it, never over the neck. The seat belt lies flat and fits comfortably on the upper part of the body.

The lap part of the seat belt lies across the pelvis, never across the stomach. The seat belt lies flat and fits comfortably on the pelvis.



» page 69



» page 71

Seat belt tensioners

During a collision, the seat belts on the front seats are retracted automatically.

The tensioner can be triggered only once.



» ⚠ in Service and disposal of belt tensioners on page 73



» page 72

Adjusting the exterior mirrors

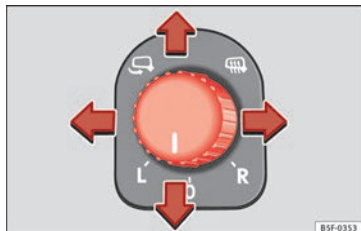


Fig. 18 Detail of the driver door: control for the exterior mirror.

Adjusting the exterior mirrors: Turn the knob to the corresponding position:

L/R Turning the knob to the desired position, adjust the mirrors on the driver

side (L, left) and the passenger side (R, right) to the direction desired.



Depending on the equipment fitted on the vehicle, the mirrors may be heated according to the outside temperature.



Folding in mirrors.



» ⚠ in Adjusting the exterior rear view mirrors on page 142



» page 141

Adjusting the steering wheel

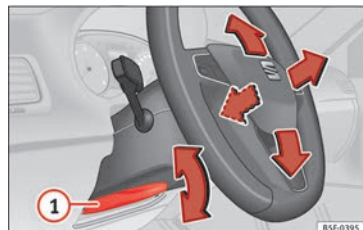


Fig. 19 Lever in the lower left side of the steering column.

• Adjusting the position of the steering wheel: Pull the » **Fig. 19** ① lever down, move the steering wheel to the desired position and lift the lever back up until it locks.



» » ⚠ in Adjusting the steering wheel position on page 64

Airbags

Front airbags



Fig. 20 Driver airbag located in steering wheel.



Fig. 21 Front passenger airbag located in dash panel.

The front airbag for the driver is located in the steering wheel » » **Fig. 20** and the airbag for the front passenger is located in the dash panel » » **Fig. 21**. Airbags are identified by the word "AIRBAG".

When the driver and front passenger airbags are deployed, the covers remain attached to the steering wheel and dashboard, respectively » » **Fig. 20** » » **Fig. 21**.

In conjunction with the seat belts, the front airbag system gives the front occupants additional protection for the head and chest in

the event of a severe frontal collision » » ⚠ in Front airbags on page 75.

Their special design allows the controlled escape of the propellant gas when an occupant puts pressure on the bag. Thus, the head and chest are protected by the airbag. After the collision, the airbag deflates sufficiently to allow visibility.



» » page 75


Deactivating the front passenger front airbag



Fig. 22 Front passenger front airbag switch.

To deactivate the front passenger front airbag:

- Open the front passenger door. » »

- Insert the key blade into the slot provided in the deactivation switch.
- Approximately $\frac{3}{4}$ of the length of the key blade remains inserted (the maximum).
- Turn the key blade, changing its position to **OFF**. Do not force it. If you have difficulty, ensure that you have inserted the key as far as it will go.
- Finally, check the control lamp on the instrument panel where it shows **PASSENGER AIR BAG OFF** ; the following should appear **OFF**.



»  in Front passenger front airbag switch on page 79



» page 78

Knee airbag*



Fig. 23 On the driver side: location of the knee airbag

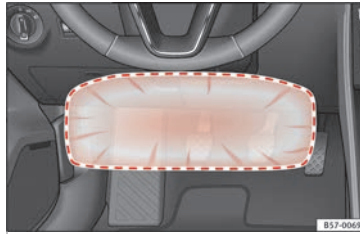


Fig. 24 On the driver side: radius of action of the knee airbag.

The knee airbag is located on the driver side below the dash panel » **Fig. 23**. Airbags are identified by the word “AIRBAG”.

The area framed in red (deployment area) » **Fig. 24** is covered by the knee airbag when it is deployed. Objects should never be placed or mounted in this area.



» page 75

Side airbags*

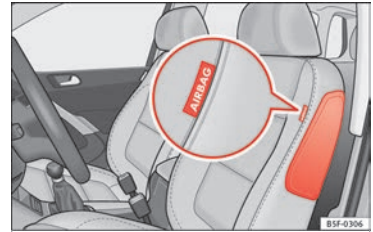


Fig. 25 Side airbag in driver's seat.

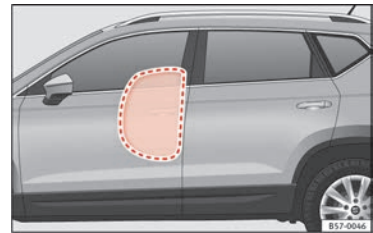


Fig. 26 Illustration of completely inflated side airbags on the left side of the vehicle.

The side airbags are located in the driver's seat and front passenger seat backrests » **Fig. 25**. The locations are identified by the text “AIRBAG” in the upper region of the backrests.

In conjunction with the seat belts, the side airbag system provides additional protection for the upper body in the event of a severe side collision » » **△ in Side airbags*** on page 75.

In a side collision, the side airbags reduce the risk of injury to passengers to the areas of the body facing the impact. In addition to their normal protection, the seat belts also hold the passengers in the event of a side collision; this is how these airbags provide maximum protection.



» » page 75

Head-protection airbags*



Fig. 27 Location of head-protection airbags.

The head-protection airbags are located on both sides in the interior above the doors » » **Fig. 27** and are identified with the text "AIRBAG".

In conjunction with the seat belts, the head-protection airbag system gives the vehicle occupants additional protection for the head and upper body in the event of a severe side collision » » **△ in Curtain airbags*** on page 76.



» » **△ in Curtain airbags*** on page 76

Child seats

Important information regarding the front passenger's airbag



Fig. 28 Passenger's side sun visor: airbag sticker.



Fig. 29 On the rear frame of the passenger side door: airbag sticker.

A sticker with important information about the passenger airbag is located on the passenger's sun visor and/or on the passenger side door frame.



» » **△ in Important information regarding the front passenger's airbag** on page 80



» » page 79

Securing child seats

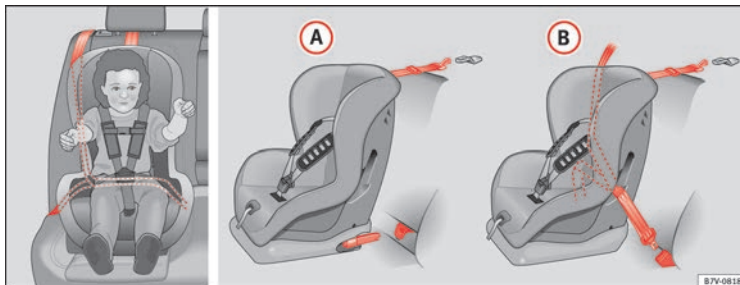


Fig. 30 On the rear seats: Possible installations for the child seat.

Figure » **Fig. 30 A** shows the basic child restraint system mounting using lower retaining rings and the upper retaining strap. Figure » **Fig. 30 B** shows the child restraint system mounting using the vehicle seat belt.

The seat belt may be used to secure **universal** type child seats to the vehicle seats marked with a **U** in the table below.

- *In the passenger seat without height adjustment:* It is necessary to place the passenger seat in its rearmost position¹⁾.

- *In the passenger seat with height adjustment:* It is necessary to place the passenger seat in its rearmost and highest position¹⁾.

To correctly use a child seat in the back, the front backrest must be adjusted so that there is no contact with the child seat in the back in the case that it goes opposite to the direction of the car. In the case of front facing restraint systems, the front backrest must be adjusted so that there is no contact with the child's feet.

To adjust the passenger seat to accommodate a child's seat and get the seat belt in a perfect position, adjust the passenger backrest as far forward as possible.¹⁾

If a semi-universal type chair is to be installed, in which the method of attachment to the car is through the seat belt and support bracket, it should never be installed in the central rear seat as the ground clearance is lower than in other places and the support bracket will not allow the seat to remain sufficiently stable.

¹⁾ Compliance with current national legislation and the manufacturer's instructions is required when using or installing child seats.

The essentials

Weight group	Seating position			
	Front passenger seat ^{a)}		Rear side seat	Rear central seat ^{b)}
	airbag on	airbag off		
Group 0 to 10 kg	X	U*	U	U
Group 0+ to 13 kg	X	U*	U	U
Group I 9 to 18 kg	X	U*	U	U
Group II 15 to 25 kg	X	U*	U	U
Group III 22 to 36 kg	X	UF*	UF	UF

a) Compliance with current national legislation and the manufacturer's instructions is required when using or installing child seats.

b) For semi-universal chairs where the securing system is the car safety belt and the support bracket, do not use them in the centre rear seat.

X: It is not compatible to install chairs in this configuration.

U: Suitable for universal restraint systems for use in this weight group.

UF: Acceptable for front-facing universal-category child restraint systems approved for this mass group.

*: Seats **without** height adjustment should be placed in their rearmost position. Seats **with** height adjustment should be placed in their rearmost and highest position.

The systems include the child restraint system mounting with an upper retaining strap (Top Tether) and lower anchoring points on the seat.



»» ⚠ in Safety instructions on page 81

“ISOFIX” and Top Tether child seat mounting system*

Child seats can be secured quickly, easily and safely on the rear outer seats with the “ISOFIX” and Top Tether* system.

Two “ISOFIX” retaining rings are fitted on each rear seat. In some vehicles, the rings are secured to the seat frame and, in others,

they are secured to the rear floor. The “ISOFIX” rings are located between the rear seat backrest and the seat cushioning »» Fig. 31. The Top Tether* rings are located on the rear part of the backrests of the rear seats (behind the seat backrest or in the boot)

»» Fig. 32.

To understand the compatibility of the “ISOFIX” systems in the vehicle, consult the table below. »»

The essentials

The body weight permitted and information regarding sizes **A** to **F** is indicated on the la-

bel on child seats with “**universal**” or “**semi-universal**” certification.

Weight group	Size class	Electrical equip- ment	Vehicle Isofix positions			
			Front passenger seat		Rear side seat	Rear central seat
			airbag on	airbag off		
Baby carrier	F	ISO/L1	X	X	X	X
	G	ISO/L2	X	X	X	X
Group 0 to 10 kg	E	ISO/R1	X	X	IL	X
Group 0+ to 13 kg	E	ISO/R1	X	X	IL	X
	D	ISO/R2	X	X	IL	X
	C	ISO/R3	X	X	IL	X
Group I 9 to 18 kg	D	ISO/R2	X	X	IL	X
	C	ISO/R3	X	X	IL	X
	B	ISO/F2	X	X	IUF/IL	X
	B1	ISO/F2X	X	X	IUF/IL	X
	A	ISO/F3	X	X	IUF/IL	X
Group II 15 to 25 kg	---	---			---	---
Group III 22 to 36 kg	---	---			---	---

IUF: Suitable for forward-facing ISOFIX universal child restraint systems approved for use in this mass group.

IL: Suitable for certain ISOFIX child restraint systems (CRSs) listed in the attached

list. This relates to ISOFIX CRSs that can be for the specific vehicle, restricted or semi-universal categories.

X: ISOFIX position not suitable for ISOFIX child restraint systems for this weight group or size class.



» » in Safety instructions on page 81

Retaining the child seat with the “ISOFIX/i-Size”



Fig. 31 ISOFIX/iSize securing rings.

You are obliged to follow the seat manufacturer's instructions.

- Remove the protective caps of the “ISOFIX/iSize” rings by placing a finger in the hole and pulling up » » Fig. 31.
- Press the child seat onto the “ISOFIX” retaining rings until the child seat can be heard to engage securely. If the child seat is equipped with Top Tether* anchor points, secure it

to the correspondent ring » » Fig. 32. Observe the manufacturer's instructions.

- Pull on both sides of the child seat to ensure that it is properly anchored.

Child seats with the “ISOFIX” and Top Tether* attachment system are available from Technical Services.

	Vehicle i-Size positions			
	Front passenger seat		Rear side seat	Rear central seat
	airbag on	airbag off		
Child restraint system approved under ECE R129	X	X	i-U	X

i-U Valid position for front-facing and rear-facing child restraint systems approved under ECE R129.

X: Invalid position for child restraint systems approved under ECE R129.

Attachment of the child seat with the Top Tether* retainer straps



Fig. 32 Position of the Top Tether rings on the back of the rear seat.

Child seats with the Top Tether system come with a strap for securing the seat to the vehicle anchor point, located at the back of the rear seat backrest and provide greater restraint.

The objective of this strap is to reduce forward movements of the child seat in a crash, to reduce the risk of injuries to the head from hitting the inside of the vehicle.

Using the Top Tether in rear-facing mounted seats

Currently, there are very few rear-facing child safety seats that have Top Tether. Please carefully read and follow the seat manufacturer instructions to learn the proper way to install the Top Tether strap.

Securing the Top Tether* to the anchorage point

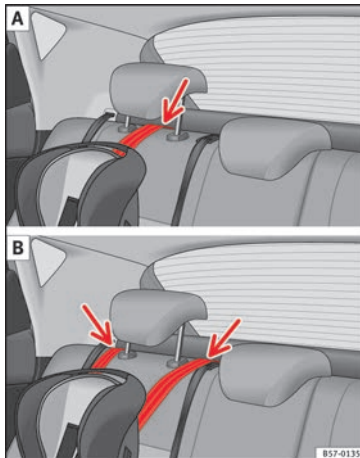


Fig. 33 Retainer strap: adjustment and assembly according to the Top Tether belt.

Securing the retainer strap

- Follow the manufacturer's instructions to deploy the child seat Top Tether retainer strap.
- Place the belt under the head restraint of the back seat »» **Fig. 33** (depending on the in-

structions of the chair itself, lift or remove the head restraint if necessary).

- Slide the strap and secure it properly with the anchorage of the backrest »» **Fig. 32**.
- Firmly tighten the strap following the manufacturer's instructions.

Releasing the retaining strap

- Loosen the strap following the manufacturer's instructions.
- Push the lock and release it from the anchoring support.



»» ⚠ in Safety instructions on page 81

Starting the vehicle

Ignition lock

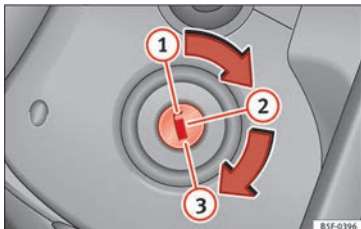


Fig. 34 Ignition key positions.

Switch ignition on: Place the key in the ignition and start the engine.

Locking and unlocking the steering wheel

- Engaging the steering wheel lock: Remove the key from the ignition and turn the wheel until it locks. In vehicles with an automatic gearbox, the gear lever must be in the **P** position in order to remove the key. If necessary, press the locking key on the selector lever and release it again.

- Unlocking the steering wheel: Put the key into the ignition and turn it at the same time as the steering wheel in the direction indicated by the arrow. If it is not possible to turn the steering wheel, it may be because it is locked.

Turning on/switching off the ignition, glow plugs reheating

- Switch ignition on: Turn the key to the ② position.
- Switch ignition off. Turn the key to the ① position.
- Diesel vehicles ∞: The glow plugs reheat when the ignition is switched on

Starting the engine

- Manual gearbox: press the clutch pedal all the way down and move the gearbox lever into neutral.
- Automatic gearbox: Press the brake pedal and move the selector lever to the **P** position or into **N**.
- Turn the key to the ③ position. The key automatically returns to the ② position. Do not press the accelerator.

Start-Stop System*

When you stop and release the clutch pedal, the Start-Stop system* turns off the engine. The ignition remains switched on.



» ∆ in Switching the ignition on and starting the engine with the key on page 166



» page 165

Lights and visibility

Light switch



Fig. 35 Dash panel: light control.

- Turn the switch to the required position
- » Fig. 35.

Sym- bol	Ignition switched off	Ignition is switched on
0	Fog lights, dipped beam and side lights off.	Daylight running lights switched on.
AUTO	The "Coming home" and "Leaving home" guide lights may be switched on.	Automatic control of dipped beam and daytime running light.
☞☞	Side light on.	Daylight running lights switched on.
☞	Dipped beam head-light off	Dipped beam switched on. »

Front fog lights: move the switch to the first position, from positions **AUTO**, \Rightarrow or \Leftarrow .

Rear fog light: move the switch completely from positions **AUTO**, \Rightarrow or \Leftarrow .

- Switching off fog lights: Push the switch or turn it to the 0 position.



» » Δ in Side light and dipped beam headlight on page 131



» » page 131

Turn signal and main beam lever

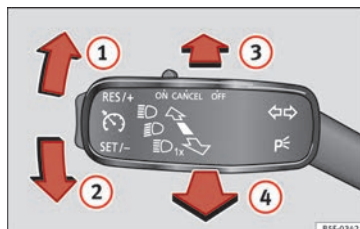


Fig. 36 Turn signal and main beam lever

Move the lever to the required position:

① Right turn signal: Right-hand parking light (ignition switched off).

② Left turn signal: Left-hand parking light (ignition switched off).

③ Main beam switched on: Control lamp \Leftarrow lit up on the instrument panel.

④ Headlight flasher: lit up when the lever is pushed. Control lamp \Leftarrow lit up.

Lever all the way down to switch it off.



» » Δ in Turn signal and main beam lever on page 132



» » page 131

Hazard warning lights

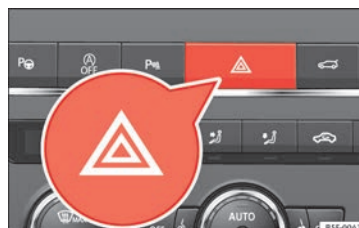


Fig. 37 Dash panel: switch for hazard warning lights.

Switched on, for example:

- When approaching a traffic jam

- In an emergency
- The vehicle has broken down
- When towing or being towed



» » Δ in Hazard warning lights Δ on page 136



» » page 135

Interior lights

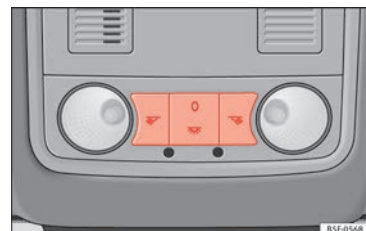




Fig. 38 Detail of headliner: front interior lighting.

Knob	Function
0	Switches interior lights off.
	Switches interior lights on.

Knob	Function
	Switches door contact control on (central position). The interior lights come on automatically when the vehicle is unlocked, a door is opened or the key is removed from the ignition. The lights go off a few seconds after all the doors are closed, the vehicle is locked or the ignition is switched on.
	Turning the reading light on and off

Ambient light*: light guide on door panel. Lighting can be selected from 8 possible colours via the menu **CAR** and the **(Setup)** function button.



» page 138

Windscreen wipers and window wiper blade

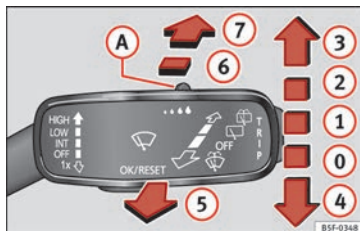





Fig. 39 Operating the windscreen wiper and rear wiper

More the lever to the required position:

0	OFF	Windscreen wiper off.
1	INT	Windscreen wipers interval wipe. Using the control » Fig. 39 (A) adjust the interval (vehicles without rain sensor), or the sensitivity of the rain sensor.

More the lever to the required position:

2	LOW	Slow wipe.
3	HIGH	Continuous wipe.
4	1x	Short wipe. Brief press, short clean. Hold the lever down for more time to increase the wipe frequency.
5		Automatic wipe. The windscreen washer function is activated by pushing the lever forwards, and simultaneously the windscreen wipers start.
6		Interval wipe for rear window. The wiper will wipe the window approximately every six seconds.
7		The rear window wash function is activated by pressing the lever, and the rear wiper starts simultaneously.



» page 139

SOS

» page 60

Easy Connect

CAR menu settings (Setup)

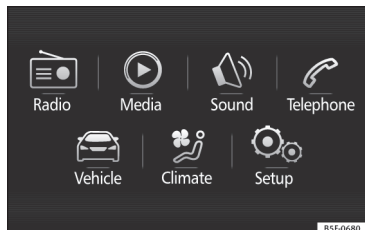


Fig. 40 Easy Connect: Main menu

To select the settings menus, press the Easy Connect **(CAR)** button and the **(Setup)** function button.

The actual number of menus available and the name of the various options will depend on the vehicle's electronics and equipment.

- Switch the ignition on.
- If the Infotainment System is off, switch it on.



Fig. 41 Easy Connect: CAR menu

- Press the system's **(MENU)** button and then the system's **(CAR)** button or **(CAR)** button to go to the **CAR** menu **»» Fig. 40** button or **(CAR)** button to go to the **CAR** menu **»» Fig. 41**.
- Press the function button **(Setup)** to open the menu **Vehicle settings** **»» Fig. 41**.
- To select a function in the menu, press the desired button.

Pressing the menu button **(⇨)** will always take you to the last menu used.

When the function button check box is activated , the function is active.

Any changes made using the settings menus are automatically saved on closing the **(BACK⇨)** menu.

Menu	Submenu	Possible setting	Description
ESC system	-	Deactivating the traction control system (ASR) or selecting the Sport mode of the electronic stability control (ESC Sport)	»» page 173

The essentials

Menu	Submenu	Possible setting	Description
Tyres	Tyre pressure monitoring	Tyre pressure storing (Calibration)	» page 295
	Winter tyres	Activation and deactivation of the speed warning. Setting the speed warning value	» page 299
Driver assistance	ACC (adaptive cruise control)	Activation/deactivation: Gear programme, temporary distance from the vehicle in front (distance level)	» page 197
	Front Assist (ambient traffic monitoring system)	Activation/deactivation: monitoring system, advance warning, distance warning display	» page 207
	City emergency braking function	Activation/deactivation of the City emergency braking function.	» page 211
	Lane Assist (system warning you if you leave the lane)	Activation/deactivation: Lane Assist, Adaptive Lane Guidance	» page 213
	Detection of traffic signs	The following functions can be activated and deactivated: – Display of traffic signs on the multi-function display – Trailer recognition (display of traffic signs for vehicles with trailer)	» page 228
	Fatigue detection	Activation/deactivation	» page 231
Parking and manoeuvring	ParkPilot	Automatically activate, front volume, front sound settings, rear volume, rear sound settings, adjust volume	» page 244
Vehicle lights	Vehicle interior lighting	Instrument and control lighting, ambient door lighting, footwell lighting	» page 138
	Coming home/Leaving home function	Start time for “Coming home” function, start time for “Leaving home” function	» page 134 » page 135
	Motorway light	Activation/deactivation	» page 136
Mirrors/windscreen wipers	Mirrors	Synchronised regulation, lower the rear-view mirror when reversing, fold in after parking	» page 14, » page 141
	Windscreen wipers	Automatic windscreen wipers, wipe when reversing	» page 25
Opening and closing	Radio-operated remote control	Convenience open function	» page 127
	Central locking system	Unlocking doors, automatic locking/unlocking, audible confirmation	» page 112



The essentials

Menu	Submenu	Possible setting	Description
Multifunction display	–	Current consumption, average consumption, volume to fill up, convenience consumers, ECOAdvice, travelling time, distance travelled, digital speed display, average speed, speeding warning, oil temperature, coolant temperature, restore data "from start", restore data "total calculation"	»» page 29
Date and time	–	Time source, set the time, automatic summer time (DST) setting, select time zone, time format, set the date, date format	–
Measurement units	–	Distance, speed, temperature, volume, consumption	–
Service	–	Chassis number, date of next SEAT service inspection, date of next oil change service	»» page 35
Factory settings	–	All settings can be reset: driver assistance, parking and manoeuvring, lights, rear view mirrors and windscreen wipers, opening and closing, multi-function display	–



»» ⚠ in CAR menu (Setup) on page 108



»» page 108

Driver information system

Introduction

With the ignition switched on, it is possible to read the different functions of the display by scrolling through the menus.

In vehicles with multifunction steering wheel, the multifunction display can only be operated with the steering wheel buttons.

The number of menus displayed on the instrument panel will vary according to the vehicle electronics and equipment.

A specialised workshop will be able to programme or modify additional functions, according to the vehicle equipment. SEAT recommends visiting a SEAT Official Service.

Some menu options can only be read when the vehicle is at a standstill.

As long as a priority 1 warning is displayed, it will not be possible to read the menus. Some warning messages can be confirmed and made to disappear with the windscreen wiper lever button or the multifunction steering wheel button.

The information system also provides the following information and displays (depending on the vehicle's equipment):

Driving data » page 33

- Vehicle status

- MFD from departure
- MFD from refuelling
- MFD total calculation

Assist systems » table on page 30

- Activate/deactivate Lane Assist
- Reverse gear*

Navigation » Booklet Navigation system

Audio » Booklet Radio or » Booklet Navigation system

Telephone » Booklet Radio or » Booklet Navigation system

Vehicle » table on page 30

⚠ WARNING

Any distraction may lead to an accident, with the risk of injury.

- Do not operate the instrument panel controls when driving.

Using the menus on the instrument panel



Fig. 42 Windscreen wiper lever: control buttons.



Fig. 43 Right side of multifunction steering wheel: control buttons.

The driver information system is controlled with the multifunction steering wheel buttons » Fig. 43 or with the windscreen wiper lever » Fig. 42 (if the vehicle is not equipped with multifunction steering wheel).

Enabling the main menu

- Switch the ignition on.
- If a message or vehicle pictogram appears, press button » Fig. 42 ① on the windscreen wiper lever or button **OK** on the multifunction steering wheel » Fig. 43.
- *If managed from the windscreen wiper lever:* to display the main screen » page 30 or to return to the main menu from another menu hold down the rocker button » Fig. 42 ②.
- *If managed from the multifunction steering wheel:* the main menu list is not displayed. To go from point to point in the main menu, press button **<** or **>** several times » Fig. 43.

Select a submenu

- Press the rocker switch » Fig. 42 ② on the windscreen wiper lever up or down or turn the thumbwheel of the multifunction steering wheel » Fig. 43 until the desired option appears marked on the menu.
- The selected option is displayed between two horizontal lines. In addition, a triangle is displayed on the right: ◀
- To consult the submenu option, press button » Fig. 42 ① on the windscreen wiper lever or button **OK** on the multifunction steering wheel » Fig. 43.

Making changes according to the menu

- With the rocker switch on the windscreen wiper lever or the thumbwheel of the multifunction steering wheel, make the desired changes. To increase or decrease the values more quickly, turn the thumbwheel faster.
- Mark or confirm the selection with button » Fig. 42 ① on the windscreen wiper lever or button **OK** on the multifunction steering wheel » Fig. 43.

Button for the driver assistance systems*

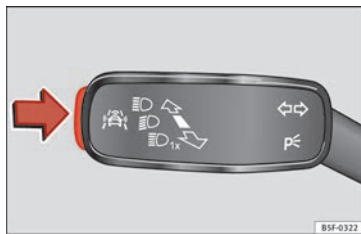


Fig. 44 On the turn signal and main beam headlight lever: button for the driver assistance systems

With the turn signal and main beam headlight lever button, you can activate or deactivate the driver assistance systems displayed

in the **Assist systems** menu » page 188.

Activate or deactivate a driver assistance system

- Briefly press the button » Fig. 44 in the direction of the arrow to open the menu **Assist systems**.
- Select the driver assistance system and activate or deactivate it » page 29. A mark indicates that driver assistance system is switched on.

Selection menu

Menu	Function
Driving data	Information and possible configurations of the multifunction display (MFD) » page 33, » page 26.
Assist systems	Information and possible configurations of the driver assistance systems » page 32, » page 26.
Navigation	Information instructions from the activated navigation system: when a route guidance is activated, the turning arrows and proximity bars are displayed. The appearance is similar to the Easy Connect system. If route guidance is not activated, the direction of travel (compass) and the name of the street along which you are driving are shown » Booklet Navigation system.

Menu	Function
Audio	Station display on the radio. Track name on the CD. Track name in Media mode » Booklet Radio or » Booklet Navigation system.
Telephone	Information and possible configurations of the mobile phone preinstallation » Booklet Radio or » Booklet Navigation system.
Vehicle status	Display of the current warning or information texts and other system components, depending on the equipment » page 108.

Outside temperature display

When the outside temperature is below +4°C (+39°F), the “ice crystal” symbol (warning of risk of freezing) is also displayed. At first, this symbol flashes and then it remains lit until the outside temperature rises above +6°C (+43°F) » **Δ in Indications on the display on page 105.**

When the vehicle is at a standstill or when travelling at very low speeds, the temperature displayed may be higher than the true outside temperature as a result of the heat produced by the engine.

The temperatures measured range from -40°C to +50°C (-40°F to +122°F).

Gear-change indicator



Fig. 45 Instrument panel: gear-change indicator (manual gearbox).

A gear change will be recommended if the gear you are in is not the most economical choice. If no gear-change is recommended, it means that you are already in the most economical gear.

Vehicles with a manual gearbox

The following display symbols » **Fig. 45** mean:

- **► Change to a higher gear:** the suggested gear appears to the **right** of the current gear when a **higher gear is recommended.**
- **◄ Change to a lower gear:** the suggested gear appears to the **left** of the current gear when a **lower gear is recommended.**

The gear recommendation may occasionally skip a gear (2nd ► 4th).

Vehicles with an automatic gearbox*

The display is only visible in tiptronic mode » **🔗** page 179.

The following display symbols mean:

- **↑ Shifting up a gear**
- **↓ Shifting down a gear**

ⓘ CAUTION

The gear-change indicator is intended to help save fuel, but it is not intended to recommend the right gear for all driving situations. In certain situations, only the driver can choose the correct gear (for instance when overtaking, driving up a steep gradient or towing a trailer).

📘 Note

The display disappears from the instrument panel when you press the clutch pedal.

Bonnet, rear lid and doors open

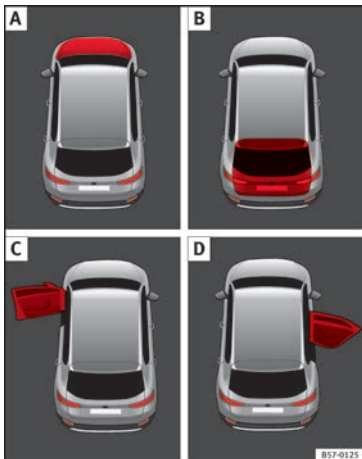


Fig. 46 A: bonnet open; B: rear lid open; C: front left door open; D: right rear door open.

When the ignition is switched on or when driving, the bonnet, rear lid or doors that are open will be indicated on the instrument panel display, and, as applicable, this will be indicated audibly. The display may vary according to the type of instrument panel fitted.

Illustration	Key to » Fig. 46
A	Do not continue driving! The bonnet is open or is not properly closed » page 282.
B	Do not continue driving! The rear lid is open or is not properly closed » page 123.
C, D	Do not continue driving! A vehicle door is open or is not properly closed » page 112.

Warning and information messages

The system runs a check on certain components and functions when the ignition is switched on and while the vehicle is moving. Faults in the operation are displayed on the screen using red and yellow symbols and messages on the instrument panel display (» page 106) and, in some cases, with audible warnings. The display may vary according to the type of instrument panel fitted.

Priority 1 warning (red symbols)

Symbol flashing or lit; partly combined with audible warnings.

Stop the vehicle! It is dangerous » in Warning and control lamps on page 107!
Check the function that is faulty and repair it. If necessary, request assistance from specialised personnel.

Priority 2 warning (yellow symbols)

Symbol flashing or lit; partly combined with audible warnings.

A faulty function, or fluids which are below the correct levels may cause damage to the vehicle! » in Warning and control lamps on page 107

Check the faulty function as soon as possible. If necessary, request assistance from specialised personnel.

Informative text

Information relating to different vehicle processes.

Submenu Assist systems

Assist systems menu	Function
ACC	Adaptive cruise control (ACC) display » page 197.
Front Assist	Switching the monitoring system on and off » page 207.
Lane Assist*	Switching the Lane Assist system on or off » page 215.
Detection of traffic signs	Display of traffic signs » page 228:
Fatigue detection*	Switching the fatigue detection on or off (pause recommendation) » page 231.

Driving data

Memory

The MFD (multifunction display) shows different values for the journey and the consumption.

Changing between display modes on the MFD

- In vehicles without multifunction steering wheel: Press the rocker switch **TRIP** on the windscreen wiper lever »» Fig. 42.
- Vehicles with a multifunction steering wheel: turn the thumbwheel »» Fig. 43.

Multifunction display memory

The multifunction display is equipped with three memories that work automatically: MFD from departure, MFD from refuelling and MFD total calculation. On the screen display, you can read which memory is currently displayed.

- Toggle between memories with the ignition on and the memory displayed: Press the **OK/RESET** button on the windscreen wiper lever or the **OK** button of the multifunction steering wheel.


Menu	Function
MFD from departure	Display and storage of the values for the journey and the consumption from when the ignition is switched on to when it is switched off. If the journey is continued in less than 2 hours after the ignition is switched off, the new data is added to the data already stored in the memory. The memory will automatically be deleted if the journey is interrupted for more than 2 hours.
MFD from refuelling	Display and storage of the values for the journey and the consumption. By refuelling, the memory will be erased automatically.
MFD total calculation	The memory records the values for a specific number of partial trips, up to a total of 19 hours and 59 minutes or 99 hours and 59 minutes, or 1999.9 km or 9999 km, depending on the model of instrument panel. On reaching either of these limits ^{a)} , the memory is automatically erased and starts to count from 0 again.

^{a)} It varies according to the instrument panel version.

Erasing a memory manually

- Select the memory that you wish to erase.
- Hold the **OK/RESET** button of the multifunction steering wheel or the **OK** button of the multifunction wheel pressed down for about 2 seconds.

Personalising the displays

In the Easy Connect system you can adjust which of the possible displays of the MFD can be shown on the instrument panel display with the button **CAR** and the function button **Setup** »»  page 108.



Data summary

Menu	Function
Current fuel consumption	The current fuel consumption display operates throughout the journey, in litres/100 km; and with the engine running and the vehicle stopped, in litres/hour.
Average fuel consumption	After turning on the ignition, average fuel consumption in litres/100 km will be displayed after travelling about 100 metres. Otherwise horizontal lines are displayed. The value shown is updated approximately every 5 seconds. ACT [®] : Depending on the equipment, number of active cylinders.
Operating range	Approximate distance in km that can still be travelled with the fuel remaining in the tank, assuming the same style of driving is maintained. This is calculated using the current fuel consumption.
Travelling time	This indicates the hours (h) and minutes (min) since the ignition was switched on.








Menu	Function
Distance covered	Distance covered in km (m) after switching on the ignition.
Average speed	The average speed will be shown after a distance of about 100 metres has been travelled. Otherwise horizontal lines are displayed. The value shown is updated approximately every 5 seconds.
Digital display of speed	Current speed displayed in digital format.
Speed warning at --- km/h or Speed warning at --- mph	If the stored speed is exceeded (between 30 - 250 km/h, or 19 - 155 mph), an audible warning is given together with a visual warning.
Detection of traffic signs	The traffic signs detected are displayed.
Oil temperature	Updated engine oil temperature digital display
Coolant temperature gauge	Digital display of the current temperature of the liquid coolant.

Storing a speed with the speed warning




- Select the display **Speed warning at --- km/h (--- mph)**
- Press the button  on the windscreen wiper lever or the button  on the multifunc-

tion steering wheel to store the current speed and activate the warning.

- To switch system on: adjust to the desired speed within 5 seconds using the rocker switch  on the windscreen wiper lever or by turning the thumbwheel on the multifunction steering wheel. Next, press the button  or  again or wait several seconds. The speed is stored and the warning activated.
- To switch system off: press the button  or . The stored speed is deleted.

Engine oil temperature display





Vehicles without multifunction steering wheel

- Press the rocker switch  **Fig. 42**  until the main menu appears. Enter into **Driving data**. With the button  move to the oil temperature gauge.





Vehicles with multifunction steering wheel

- Enter the submenu **Driving data** and turn the thumbwheel until the oil temperature display appears.

The engine reaches its operating temperature when in normal driving conditions, the oil temperature is between **80°C (180°F)** and **120°C (250°F)**. If the engine is required to

work hard and the outside temperature is high, the engine oil temperature can increase. This does not present any problem as long as the warning lamps   **table on page 39** or   **table on page 39** do not appear on the display.

Additional electrical appliances

- *Operation with the windscreen wiper lever**: Press the rocker switch  **Fig. 42**  until the main menu appears. Enter into the section **Driving data**. With the rocker switch, move to the display **Convenience consumers**.
 - *Operation with the multi-function steering wheel**: Move with the buttons  or  to **Driving data** and enter with **OK**. Turn the thumbwheel to the right until the **Convenience consumers** display appears.
- In addition, a scale will inform you of the current sum of all the additional appliances.

Saving tips



Tips on how to save fuel will be displayed in conditions that increase fuel consumption. Follow them to reduce consumption. The indications appear automatically only with the efficiency programme. After a time, the tips will disappear automatically.

If you wish to hide a saving tip immediately after it appears, press any button on the windscreen wiper lever*/multifunction steering wheel*.

Note

- If you hide a saving tip, it will reappear after you switch the ignition on again.
- The saving tips do not appear in all situations, but rather with a large separation of time.



Speed warning device

The speed warning device warns the driver when they have exceeded the pre-set speed limit by 3 km/h (2 mph). An audible warning signal sounds, and the warning lamp  and the driver message **Speed limit exceeded!** will be displayed simultaneously on the instrument panel. The warning lamp  switches off when reducing speed below the stored maximum limit.

Speed warning programming is recommended if you wish to be reminded of a maximum speed, such as when travelling in a country with different speed limits or for a maximum speed for winter tyres.

Setting speed limit warning

You can use the radio or the Easy Connect* to set, alter or cancel the speed limit warning.



- **Vehicles with radio:** press the button  **SETUP** > control button  **Driver Assistant** > **Speed warning**.
- **Vehicles with Easy Connect:** press the button **Systems** or else **Vehicle systems** > **Driver assistant** > **Speed warning**.

The warning limit can be set from 30 to 240 km/h (20 to 149 mph). The adjustment is made at 10 km/h (5 mph) intervals.

Note

- Please bear in mind that, even with the speed warning function, it is still important to keep an eye on the vehicle speed with the speedometer and to observe the legal speed limits.
- The speed limit warning function in the version for some countries warns you at a speed of 120 km/h (75 mph). This is a factory-set speed limit.

Service intervals

The service interval indication appears on the instrument panel display  **Fig. 115** .


SEAT distinguishes between services *with* engine oil change (e.g. Oil change service) and services *without* engine oil change (e.g. Inspection).


In vehicles with **Services established by time or mileage**, the service intervals are already pre-defined.

In vehicles with **LongLife Service**, the intervals are determined individually. Thanks to technological progress, maintenance work has been greatly reduced. Because of the technology used by SEAT, with this service you only need to change the oil when the vehicle so requires. To calculate this change (max. 2 years), the vehicle's conditions of use and individual driving styles are considered. The advance warning first appears 20 days before the date established for the corresponding service. The kilometres (miles) remaining until the next service are always rounded up to the nearest 100 km (miles) and the time is given in complete days. The current service message cannot be viewed until 500 km after the last service. Prior to this, only lines are visible on the display.

Inspection reminder

When the Service date is approaching, when the ignition is switched on a **Service reminder** is displayed.

Vehicles without text messages: a spanner  will be displayed on the instrument panel plus an indication in **km**.

The kilometres indicated are the maximum number of kilometres that can be travelled until the next service. After a few seconds, 

the display mode changes. A clock symbol appears and the number of days until the next service is due.

Vehicles with text messages: **Service in --- km or --- days** will be shown on the instrument panel display.


Service due

When **the service date is due**, an audible warning is given when the ignition is switched on and the spanner displayed on the screen flashes for a few seconds.

Vehicles with text messages: **Service now** will be shown on the instrument panel display.




Reading a service notification

With the ignition switched on, the engine off and the vehicle at a standstill, the current **service notification** can be read:

Press and hold the button »»  **Fig. 115 4** for more than 5 seconds to consult the service message.




When the **service date has passed**, a minus sign is displayed in front of the number of kilometres or days.

Vehicles with text messages: the following message is displayed: **Service --- km (miles) or --- days ago**.



The time can also be set via the  key and  function button in the Easy Connect system »»  page 108.

Resetting service interval display

If the service was not carried out by a SEAT dealership, the display can be reset as follows:

- Switch off the ignition, press and hold button »»  **Fig. 115 4**.
- Switch ignition back on.
- Release THE  »»  **Fig. 115** button and press it again for the next 20 seconds.

Note

- The service message disappears after a few seconds, when the engine is started or when  is pressed on the windscreen wiper lever, or  on the multifunction steering wheel.
- In vehicles with the LongLife system in which the battery has been disconnected for a long period of time, it is not possible to calculate the date of the next service. Therefore the service interval display may not be correct. In this case, bear in mind the maximum service intervals permitted in the »» Booklet Maintenance Programme.
- If you reset the display manually, the next service interval will be indicated as in vehicles with fixed service intervals. For this reason we recommend that the service interval display be reset by a SEAT authorised Dealer.

Cruise control

Operating the cruise control system (CCS)*

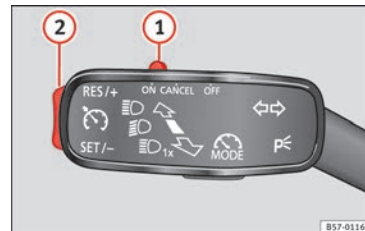


Fig. 47 On the left of the steering column: switches and controls for operating the CCS

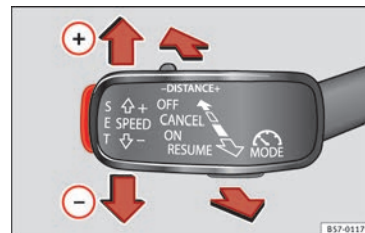


Fig. 48 On the left of the steering column: third lever to operate the CCS.

Operation of the turn signal lever

- Switching on the CCS: Move switch »» Fig. 47 ① to **ON**. The system is on. If no speed has been programmed, the system will not control it.
- Activating the CCS: Press button »» Fig. 47 ② in the **SET/-** area. The current speed is memorised and controlled.
- Temporarily switching off the CCS: Move switch »» Fig. 47 ① to **CANCEL** or push the brake. The cruise control system is switched off temporarily.
- Reactivating the CCS: Press button »» Fig. 47 ② in **RES/+**. The memorised speed is saved and controlled again.
- Increasing stored speed during CCS regulation: press button ② in **RES/+**. The vehicle accelerates until the new stored speed.

- Reducing stored speed during CCS regulation: press button ② in **SET/-** to lower the speed by 1 km/h (1 mph). Speed is reduced until reaching the new stored speed.
- Switching off the CCS: Move switch »» Fig. 47 ① to **OFF**. The system is disconnected and the memorised speed is deleted.

Operation using the third lever

- Switching on the CCS: move the third lever to **ON** »» Fig. 48. The system switches on but it does not control the speed as no speed has been programmed.
- Activating the CCS: press the **SET** »» Fig. 48 button. It memorises and maintains the current speed.
- Temporarily switching off the CCS: move the lever to **CANCEL** »» Fig. 48 and release it or

press the brake pedal. The cruise control system is switched off temporarily.

- Reactivating the CCS: move the lever to **RESUME** »» Fig. 48 and release it. The memorised speed is saved and controlled again.
- Switching off the CCS: move the third lever to position **OFF** »» Fig. 48. The system is disconnected and the memorised speed is deleted.



»» ⚠ in Operation on page 193



»» page 193

Warning lamps

On the instrument panel

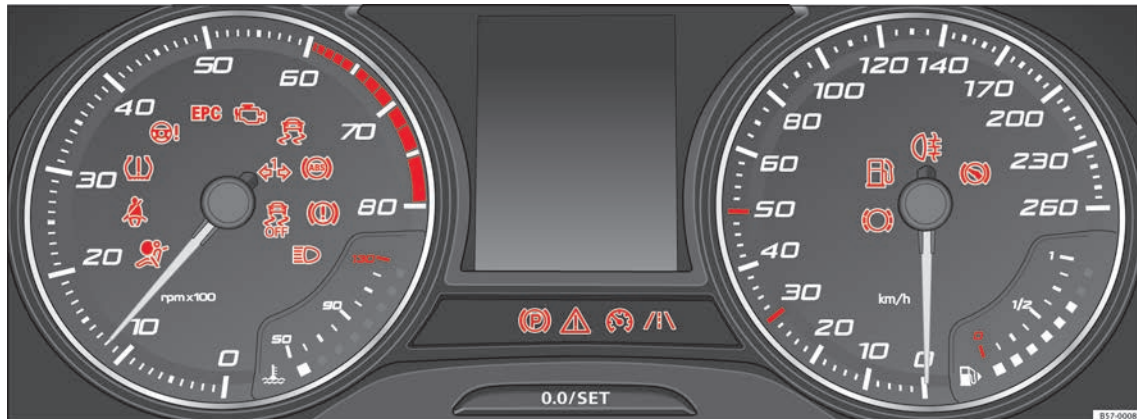


Fig. 49 Instrument panel, on dash panel













Red warning lamps


	Central warning lamp: additional information on the instrument panel display	-
	Parking brake on.	» page 170
	Do not continue driving! The brake fluid level is too low or there is a fault in the brake system.	» page 172

	<i>Lit up or flashing:</i> Do not continue driving! Fault in the steering.	» page 273
	Driver or passenger has not fastened seat belt.	» page 68
	Use the foot brake!	










Yellow warning lamps

	Central warning lamp: additional information on the instrument panel display	-
--	--	---

	Front brake pads worn.	
	<i>it lights up:</i> Fault in the ESC, or disconnection caused by the system.	» page 173
	<i>flashes:</i> ESC or ASR activated.	
	ASR manually deactivated.	
	ESC in Sport mode.	» page 173
	ABS faulty or does not work.	
	Rear fog light switched on.	» page 131
	<i>lights up or flashes:</i> fault in the emission control system.	» page 186
	<i>it lights up:</i> pre-heating of diesel engine.	» page 187
	<i>flashes:</i> fault in the diesel engine management.	
EPC	fault in the petrol engine management.	» page 187
	<i>lights up or flashes:</i> fault in the steering system.	» page 273
	Tyre pressure too low, or fault in the tyre pressure monitoring system.	» page 295
	Fuel tank almost empty.	» page 102
	Fault in airbag system and seat belt tensioners.	» page 73

	Lane Assist is switched on, but not active.	» page 213
---	---	------------

Other warning lamps

	Left or right turn signal.	» page 131
	Hazard warning lights on.	» page 135
	Trailer turn signals.	» page 255
	<i>it lights up green:</i> Auto Hold activated.	» page 191
	<i>it lights up green:</i> Press the brake pedal! <i>It blinks in green:</i> the selector lever locking button has not engaged.	» page 177
	<i>it lights up green:</i> cruise control activated or speed limiter switched on and active.	» page 193
	<i>it blinks in green:</i> the speed set by the speed limiter has been exceeded.	
	<i>it lights up green:</i> Lane Assist is switched on and active.	» page 213
	Main beam on or flasher on.	» page 131

On the instrument panel display

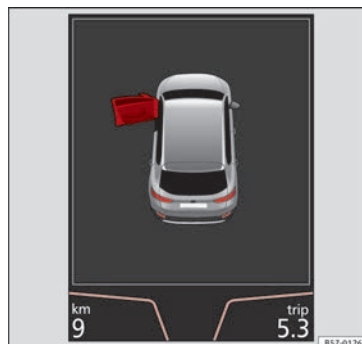




















Fig. 50 On the instrument panel display: door open.

	Do not continue driving! With the corresponding indication: door(s), rear lid or bonnet open or not properly closed.	» page 112 » page 123 » page 282
	Ignition: Do not carry on driving! Engine coolant level too low, coolant temperature too high	» page 286
	Flashing: Fault in the engine coolant system.	







	Do not continue driving! Engine oil pressure too low. If the warning lamp flashes, stop driving, even if the oil level is correct. Do not even run the engine at idle speed!	»» page 284
	Fault in the battery.	»» page 289
	Driving light totally or partially faulty.	»» page 93
	Fault in the cornering light system.	»» page 131
	Diesel particulate filter blocked	»» page 186
	Level of windscreen washer fluid too low.	»» page 139
	<i>Flashing:</i> Fault in the oil level detection. Control manually. <i>Ignition:</i> Insufficient engine oil.	»» page 284
	Fault in the gearbox.	»» page 183
	Light Assist on.	»» page 132
SAFE	Immobiliser active.	
	Service interval display	»» page 35

	Mobile telephone is connected via Bluetooth to the original telephone device.	»» Book-let Radio or »» Book-let Navigation system
	Mobile telephone battery charge meter. Available only for devices pre-installed in factory.	
	Freezing warning. The outside temperature is lower than +4°C (+39°F).	»» page 31
	Start-Stop system activated.	»» page 188
	Start-Stop system unavailable.	
ECO	Low consumption driving status	»» page 30


On the instrument panel



Fig. 51 Warning lamp for disabling the front passenger airbag.

	Front passenger front airbag is disabled (PASSENGER AIR BAG OFF ).	»» page 73
	The front passenger front airbag is activated (PASSENGER AIR BAG ON ).	»» page 73



»»  in Warning and control lamps on page 107



»» page 106

Gearbox lever

Manual gearbox

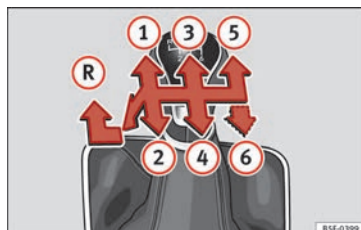


Fig. 52 Gear shift pattern of a 5 or 6-speed manual gearbox

The position of the gears is indicated on the gearbox lever »» **Fig. 52**.

- Press the clutch pedal and keep your foot right down.
- Move the gearbox lever to the required position.
- Release the clutch.

Selecting reverse gear

- Press the clutch pedal and keep your foot right down.
- With the gearbox lever in neutral, push it upwards, move it to the left as far as it will go and then forwards to select reverse »» Fig. 52 **R**.
- Release the clutch.



»» ⚠ in Changing gear on page 176



»» page 176

Automatic gearbox*

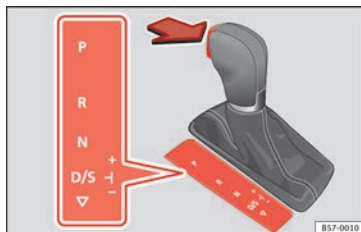


Fig. 53 Automatic gearbox: selector lever positions.

P Parking lock

R Reverse gear

N Neutral (idling)

D/S Drive (forward)

+/- Tiptronic mode: pull the lever forwards (+) to go up a gear or backwards (-) to go down a gear.



»» ⚠ in Selector lever positions on page 177



»» page 177

SOS

»» page 41

Manual release of the selector lever

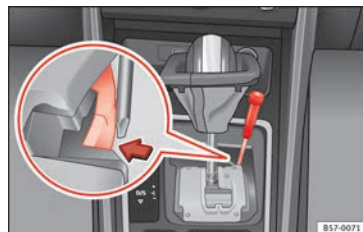


Fig. 54 Selector lever: manual release from position P.

Should the power supply be interrupted, there is a manual unlocking device located under the console of the selector lever, on the right. Releasing the selector lever requires a certain degree of practical skill.

- Unlocking: use the flat part of a screwdriver blade.

Removing the cover from the selector lever

- Apply the handbrake **Ⓜ** »» ⚠ to ensure that the car does not move.
- Carefully pull the corners of the selector lever boot and twist it upwards above the lever handle.

»»

Releasing the selector lever

- Using a screwdriver, press and hold the yellow unlocking tab sideways » Fig. 54.
- Press the interlock button on the selector lever and move the selector lever to position **N**.
- After carrying out the manual release, attach the selector lever boot on the gearbox console again.

If the power supply should ever fail (e.g. discharged battery) and the vehicle has to be pushed or towed, the selector lever must first be moved to position **N**, after operating the manual release mechanism.

⚠ WARNING

The selector lever may be moved out of position **P** only when the handbrake is firmly applied. If this does not work, secure the vehicle with the brake pedal. On a slope the vehi-

cle could otherwise start to move inadvertently after shifting the selector lever out of position **P** - accident risk!

Air conditioning

How does Climatronic* work?

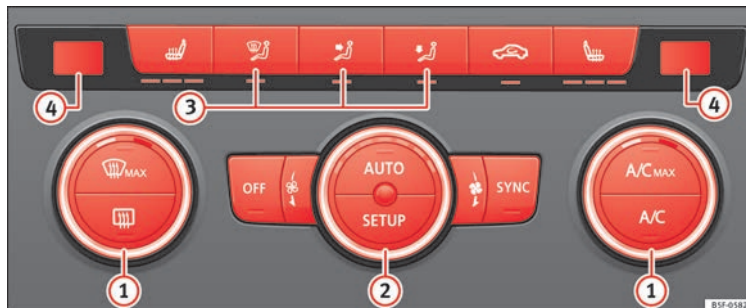















Fig. 55 In the centre console: Climatronic controls

The essentials

To switch a specific function on, press the appropriate button. Press the button again to switch off the function.

The LED on each control lights up to indicate that the respective function of a control has been switched on.

 Temperature	The left and right sides can be adjusted separately: Turn the control to adjust the temperature
 Fan	The power of the fan is automatically adjusted. The fan is also adjusted manually by turning the control.
 Air distribution	The airflow adjusts automatically for comfort. You can also switch it on manually using the buttons  .
	Indications on the temperature display screen selected for the right and left sides.
 Defrost function	The air drawn in from outside the vehicle is directed at the windscreen and air recirculation is automatically switched off. To defrost the windscreen more quickly, the air is dehumidified at temperatures over approximately +3°C (+38°F) and the fan runs at maximum output.
	The air is directed at the chest of driver and passengers by the dash panel air vents.
	Air distribution towards the footwell.
	Upward air distribution.
	Heated rear window: this only works when the engine is running and switches off automatically after a maximum of 10 minutes.
	Air recirculation
	Seat heating buttons
A/C	Press the button to switch on or off the cooling system.
A/C MAX	Press the button to make maximum cooling capacity available. The recirculation of air and the cooling system turn on automatically and air distribution adjusts automatically to the position  .
SYNC	When the warning light for button SYNC lights up, the settings on the driver side also apply to the passenger side. Press the button or the temperature control on the passenger side



The essentials

AUTO	Automatic adjustment of temperature, fan, and air distribution. Press the button: the warning lamp on the button will light up AUTO .
SETUP	Press the configuration button SETUP : the air conditioning operation menu will be displayed on the Easy Connect system screen.
Switching off	Turn the blower control to the 0 position or press the OFF button.



»  in Introduction on page 157



» page 156

How does the manual air conditioning work*?















Fig. 56 In the centre console: Manual air conditioning controls

To switch a specific function on, press the appropriate button. Press the button again to switch off the function.

The LED on each control lights up to indicate that the respective function of a control has been switched on.

The essentials

 Temperature	Turn the control to adjust the temperature
 Fan	Setting 0: blower and manual air conditioning switched off Level 6: maximum fan level.
 Air distribution	Rotate the continuous control to direct the airflow to the desired area.
 Defrost function	The airflow is directed at the windscreen. Air recirculation is automatically switched off or is not switched on. Increase the fan power to clear the windscreen of condensation as soon as possible. To dehumidify the air, the cooling system will automatically switch on.
	The air is directed at the chest of driver and passengers by the dash panel air vents.
	Distribution of air towards the chest and the footwell area.
	Air distribution towards the footwell.
	Air distribution towards the windscreen and the footwell.
	Heated rear window: this only works when the engine is running and switches off automatically after a maximum of 10 minutes.
	Air recirculation
	Seat heating buttons
A/C MAX	Maximum cooling power. The recirculation of air and the cooling system turn on automatically and air distribution adjusts automatically to the position 



»  in Introduction on page 157



» page 156





How does the heating and the fresh air system work?








Fig. 57 In the centre console: heating system and fresh air controls.

To switch a specific function on, press the appropriate button. Press the button again to switch off the function.

The LED on each control lights up to indicate that the respective function of a control has been switched on.

<p>①</p> <p>Temperature</p>	Turn the control to adjust the temperature. The temperature cannot be lower than that of the exterior air temperature, as this system cannot cool or dehumidify the air
<p>②</p> <p>Fan</p>	Setting 0: blower, heating and fresh air systems switched off Level 6: maximum fan level
<p>③</p> <p>Air distribution</p>	Rotate the continuous control to direct the airflow to the desired area.
 Defrost function	The airflow is directed at the windscreen.
 	The air is directed at the chest of driver and passengers by the dash panel air vents.
	Distribution of air towards the chest and the footwell area.

The essentials

	Air distribution towards the footwell.
	Air distribution towards the windscreen and the footwell.
	Heated rear window: this only works when the engine is running and switches off automatically after a maximum of 10 minutes
	Air recirculation »» page 160
	Seat heating buttons



»»  in Introduction on page 157



»» page 156

Fluid Level control

Filling capacities

Tank level

Petrol and diesel engines	50 l, of which, approx. 7 l reserve
	<i>Four-wheel drive vehicles:</i> 55 l, of which approx. 8.5 l reserve

Capacity of the windscreen washer fluid container

Versions without headlight washer system	approx. 3 litres
Versions with headlight washer system	approx. 5 litres

Fuel

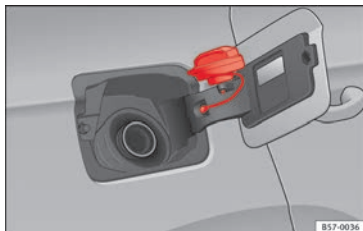


Fig. 58 Fuel tank flap with tank cap attached.

The flap that covers the tank cap is unlocked and locked automatically using the central locking.

Opening the fuel tank cap

- Open the fuel tank flap by pressing on the left side.
- Unscrew the cap by turning it to the left.
- Place it in the space on the hinge of the open flap » **Fig. 58.**

Closing the fuel tank cap

- Unscrew the cap by turning it to the right as far as it will go.
- Close the lid.



» ⚠ in Filling up on page 276



» page 276

Oil

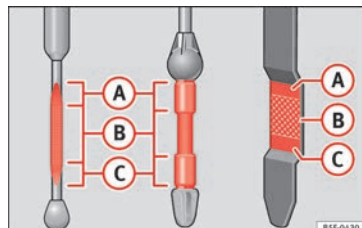


Fig. 59 Engine oil dipstick.



Fig. 60 In the engine compartment: Engine oil filler cap

The level is measured using the dipstick located in the engine compartment
» page 282.

The oil should leave a mark between zones **A** and **C**. It should never exceed zone **A**.

- Zone **A**: Do not add oil.

- Zone **(B)**: You can add oil but keep the level in that zone.
- Zone **(C)**: Add oil up to zone **(B)**.

Topping up engine oil

- Unscrew cap from oil filler opening.
- Add oil slowly.
- At the same time, check the level to ensure you do not add too much.
- When the oil level reaches at least zone **(B)**, unscrew the engine oil filler cap carefully.

Oil properties

Engine type	Specification
Petrol without flexible service interval	VW 502 00/VW 504 00
Petrol with flexible service interval (LongLife)	VW 504 00
Diesel. Engines without Particulate filter (DPF)	VW 505 01/VW 506 01/VW 507 00
Diesel. Particulate Filter Engines (DPF). With or without flexible service interval (with and without LongLife) ^{a)}	VW 507 00

^{a)} Only use recommended oils, otherwise you may damage the engine.

Engine oil additives

No type of additive should be mixed with the engine oil. The deterioration caused by these additives is not covered by the warranty.



» ⚠ in Changing engine oil on page 286



» page 284

Coolant

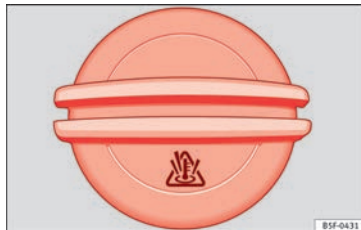


Fig. 61 Engine compartment: coolant expansion tank cap.

The coolant tank is located in the engine compartment » page 282.

When the engine is cold, replace the coolant when the level is below **MIN**.

Coolant specifications

The engine cooling system is supplied from the factory with a specially treated mixture of water and at least 40 % of the additive **G13** (TL-VW 774 J), purple. This mixture gives the necessary frost protection down to -25°C (-13°F) and protects the light alloy parts of the engine cooling system against corrosion. It also prevents scaling and considerably raises the boiling point of the coolant.

To protect the cooling system, the percentage of additive must always be at least 40 %, even in warm climates where anti-freeze protection is not required.

If for weather reasons further protection is necessary, the proportion of additive may be increased, but only up to 60 %; otherwise antifreeze protection will diminish and this will worsen cooling.

When the coolant is topped up, use a mixture of **distilled water** and at least 40 % of the G13 or G12 plus-plus (TL-VW 774 G) additive (both are purple) to obtain an optimum anti-corrosion protection » **in Topping up coolant on page 287**. The mixture of G13 with G12 plus (TL-VW 774 F), G12 (red) or G11 (green-blue) engine coolants will significantly reduce anti-corrosion protection and should therefore be avoided » **in Topping up coolant on page 287**.





» » ⚠ in Topping up coolant on page 287



» » page 286

Brake fluid



Fig. 62 Engine compartment: brake fluid reservoir cap

The brake fluid reservoir is located in the engine compartment » » 📖 page 282.

The level should be between the **MIN** and **MAX** marks. If it is below **MIN**, please visit a Technical Service.



» » ⚠ in Topping up brake fluid on page 288



» » page 287

Windscreen washer



Fig. 63 In the engine compartment: windscreen washer reservoir top.

The windscreen washer reservoir is located in the engine compartment » » 📖 page 282.

To top up, mix water with a product recommended by SEAT.

In cold temperatures, add anti-freeze.



» » ⚠ in Checking and topping up the windscreen washer reservoir on page 288



» » page 288

Battery

The battery is located in the engine compartment » » 📖 page 282. It does not require

maintenance. It is checked as part of the Inspection Service.



» » ⚠ in Important safety warnings for handling a vehicle battery on page 290



» » page 289

Emergencies

Fuses

Fuse location

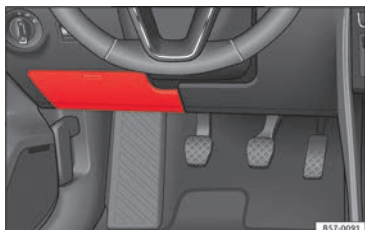


Fig. 64 On the driver-side dash panel: fuse box cover

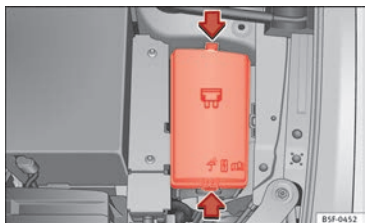


Fig. 65 In the engine compartment: fuse box cover

Underneath the instrument panel

The fuse box is located behind the storage compartment »» **Fig. 64**.

In the engine compartment

Press the locking tabs to release the fuse box cover »» **Fig. 65**.

Identifying fuses situated below the dash panel by colours

Colour	Amp rating
Black	1
Purple	3
Light brown	5
Brown	7.5
Red	10
Blue	15
Yellow	20
White or transparent	25
Green	30
Orange	40



»» ⚠ in Introduction on page 90



»» page 90

Replacing a blown fuse

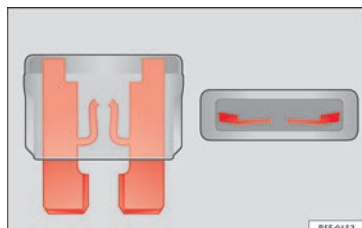



Fig. 66 Image of a blown fuse

Preparation

- Switch off the ignition, lights and all electrical equipment.
- Open the corresponding fuse box »»  page 91.

Identifying a blown fuse

A fuse is blown if its metal strip is ruptured »» **Fig. 66**.

- Point a lamp at the fuse to see if it has blown.

To replace a fuse

- Remove the fuse.
- Replace the blown fuse by one with an *identical* amperage rating (same colour and markings) and *identical* size. »»

- Replace the cover again or close the fuse box lid.

Bulbs

Bulbs (12 V)

Light source used for each function

Halogen headlights	Type
Daytime running light/side light	LED (it cannot be replaced)
Dipped beam headlights	H7 LL
Main beam headlights	H7 LL
Turn signal	PY21W

Full-LED main headlights

No bulbs may be replaced. All functions are with LEDs

Front fog light	Type
Fog/cornering lights*	H8

Rear lights	Type
Brake light/tail light	P21W LL
Side lights	P21W LL
Turn signal	PY21W LL

Rear lights	Type
Retro fog light	P21W LL
Reverse lights	W16W

LED rear lights	Type
Turn signal	PY21W LL
Reverse lights	W16W
The remaining functions work with LEDs	



» page 93

Action in the event of a puncture

What to do first

- Park the vehicle on a horizontal surface and in a safe place as far away from traffic as possible.
- Apply the handbrake.
- Switch on the hazard warning lights.
- *Manual gearbox:* select the 1st gear.
- *Automatic gearbox:* Move the selector lever to position **P**.
- If you are towing a trailer, unhitch it from your vehicle.

- Have the vehicle tool kit » page 83 and the spare wheel* ready » page 298.

- Observe the applicable legislation for each country (reflective vest, warning triangles, etc.).

- All occupants should leave the vehicle and wait in a safe place (for instance behind the roadside crash barrier).

WARNING

- **Always observe the above steps and protect yourself and other road users.**
- **If you change the wheel on a slope, block the wheel on the opposite side of the car with a stone or similar to prevent the vehicle from moving.**

Repairing a tyre with the anti-puncture kit

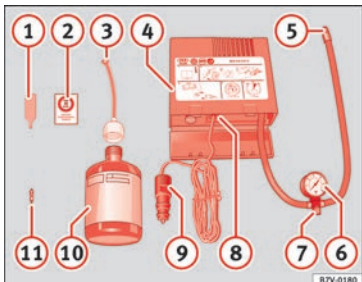


Fig. 67 Standard representation: contents of the anti-puncture kit.

The anti-puncture kit is located under the floor panel in the luggage compartment.

Sealing the tyre

- Unscrew the tyre valve cap and insert. Use the » Fig. 67 ① tool to remove the insert. Place it on a clean surface.
- Shake the tyre sealant bottle vigorously » Fig. 67 ⑩.
- Screw the inflator tube » Fig. 67 ③ into the sealant bottle. The bottle's seal will break automatically.

- Remove the lid from the filling tube » Fig. 67 ③ and screw the open end of the tube into the tyre valve.
- With the tyre sealant bottle upside down, fill the tyre with the contents of the sealant bottle.
- Remove the bottle from the valve.
- Place the insert back into the tyre valve using the tool » Fig. 67 ①.

Inflating the tyre

- Screw the compressor tyre inflator tube » Fig. 67 ⑤ into the tyre valve.
- Check that the air bleed screw is closed » Fig. 67 ⑦.
- Start the engine and leave it running.
- Insert the connector » Fig. 67 ⑨ into the vehicle's 12-volt socket » page 148.
- Turn the air compressor on with the ON/OFF switch » Fig. 67 ⑧.
- Keep the air compressor running until it reaches 2.0 to 2.5 bar (29-36 psi/200-250 kPa). **a maximum of 8 minutes.**
- Disconnect the air compressor.
- If it does not reach the pressure indicated, unscrew the tyre inflator tube from the valve.
- Move the vehicle 10m so that the sealant is distributed throughout the tyre.

- Screw the compressor tyre inflator into the valve.
- Repeat the inflation process.
- If the indicated pressure still cannot be reached, the tyre is too badly damaged. Stop and request assistance from an authorised technician.
- Disconnect the air compressor. Unscrew the tyre inflator tube from the tyre valve.
- When the tyre pressure is between 2.5 and 2.0 bars, continue driving without exceeding 80 km/h (50 mph).
- Check the pressure again after 10 minutes » page 85.



» ⚠ in TMS (Tyre Mobility System)* on page 83



» page 83

Changing a wheel

Vehicle tool kit

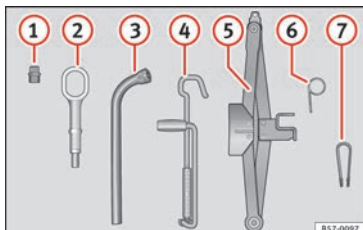


Fig. 68 Underneath the floor panel of the luggage compartment: vehicle tool kit.

- ① An adapter for the anti-theft wheel bolts*
- ② Towline anchorage
- ③ Box spanner for wheel bolts*
- ④ Crank handle for jack
- ⑤ Jack*
- ⑥ Hook for extracting the central wheel trims*
- ⑦ Clip for removing the wheel bolt caps.



» » in What to do first on page 52



» » page 83

Central wheel trim*

The central trims must be removed for access to the wheel bolts.

Removing

- Attach the wire hook (vehicle tools) to one of the chambers of the central wheel trim.
- Insert the box spanner through the hook, supporting it on the tyre and remove the wheel trim.

Fitting

- Fit the central wheel trim onto the wheel rim by pressing it firmly.
- Next fit the rest of the central wheel trim.

Wheel bolt caps*



Fig. 69 Wheel: wheel bolts with caps.

Removal

- Fit the plastic clip (vehicle tools) » » **Fig. 68** ⑦ over the cap until it clicks into place » » **Fig. 69**.
- Remove the cap with the plastic clip.

Anti-theft wheel bolts

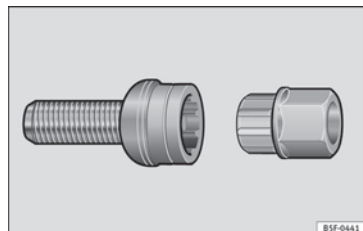


Fig. 70 Anti-theft wheel bolt with cap and adapter.

- Remove the wheel cover* or the cap*.
- Insert the special adapter (vehicle tools) onto the anti-theft wheel bolt and push it on as far as it will go.
- Insert the wheel brace (vehicle tools) onto the adapter as far as it will go.
- Remove the wheel bolt » » page 55.

Note

Make a note of the code number of the anti-theft wheel bolt and keep it in a safe place, but not in your vehicle. If you need a new adapter, you can obtain it from the SEAT Official Service, indicating the code number.

Loosening the wheel bolts



Fig. 71 Wheel: loosen the wheel bolts.

- Insert the box spanner (vehicle tools) onto the wheel bolt as far as it will go. An adapter is required to unscrew or tighten the anti-theft wheel bolts » page 54.
- Turn the wheel bolt approximately one turn to the left » Fig. 71 (arrow). To apply the required torque, hold the wheel brace at the end. If it is not possible to loosen a wheel bolt, carefully apply pressure with one foot on the end of the box spanner. Hold on to the vehicle for support and take care not to slip.

WARNING

Slightly loosen the wheel bolts (one turn) before raising the vehicle with the jack*. If not, an accident may occur.

Lifting the vehicle

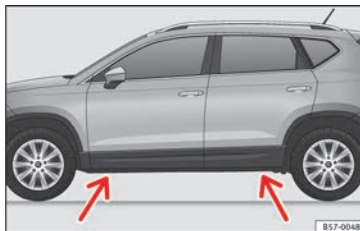


Fig. 72 Crossbar: marks.

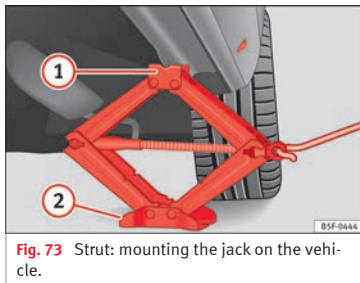


Fig. 73 Strut: mounting the jack on the vehicle.

- Place the jack* (vehicle tools) on firm ground. If necessary use a large, strong board or similar support. If the surface is slippery (for example tiles) place the jack on a rubber mat or similar to prevent it from slipping » **WARNING**.
- Find the support point on the strut (sunken area) closest to the wheel to be changed » **Fig. 72**.
- Turn the jack* crank handle, located below the strut support point, to raise it until the tab **1** » **Fig. 73** is below the housing provided.
- Align the jack* so that tab **1** “grips” onto the housing provided on the strut and the mobile base **2** is resting on the ground. The base plate **2** should fall vertically with respect to the support point **1**.
- Continue turning the jack* until the wheel is slightly lifted off the ground.

WARNING

- Make sure that the jack* remains stable. If the surface is slippery or soft, the jack* could slip or sink, respectively, with the resultant risk of injury.
- Only raise the vehicle with the jack* supplied by the manufacturer. Other vehicles could slip, with the consequent risk of injury.
- Only mount the jack* on the support points designed for this purpose on the strut, and always align the jack correctly. If you do not,



the jack* could slip as it does not have an adequate grip on the vehicle: risk of injury!

• **The height of the parked vehicle can change as a result of variations in temperature and loading.**

ⓘ CAUTION

The vehicle must not be raised on the crossbar. Only place the jack* on the points designed for this purpose on the strut. Otherwise, the vehicle may be damaged.

Removing and fitting a wheel

Change the wheel after loosening the wheel bolts and raising the vehicle with the jack.

Taking off the wheel

- Unscrew the wheel bolts using the box spanner and place them on a clean surface.
- Take off the wheel.

Putting on the spare wheel

When fitting tyres with a compulsory rotation direction, observe the instructions in »» page 56.

- Mount the wheel.
- Screw on the wheel bolts in position and tighten them loosely with a box spanner.
- Carefully lower the vehicle using the jack*.

- Tighten the wheel bolts in diagonal pairs using the wheel brace.

The wheel bolts should be clean and turn easily. Before fitting the spare wheel, inspect the wheel condition and hub mounting surfaces. These surfaces must be clean before fitting the wheel.



Tyres with compulsory direction of rotation

A directional tread pattern can be identified by the arrows on the sidewall that point in the direction of rotation. Always observe the direction of rotation indicated when fitting the wheel to guarantee optimum properties of this type of tyres with regard to grip, noises, wear and aquaplaning.

If it is absolutely necessary to fit the spare tyre* against the direction of rotation, drive with care as this means the tyre does not offer optimum driving properties. This is of particular importance when the road surface is wet.

To return to directional tread tyres, replace the punctured tyre as soon as possible and restore the obligatory direction of rotation of all tyres.

Subsequent work


- *Alloy wheels:* replace the wheel bolt caps.
- *Plate wheels:* fit the central wheel rim again »» page 54.
- Return all tools to their proper storing location.
- If the replaced wheel does not fit in the spare wheel housing, store it safely in the luggage compartment »»  page 149.
- Check the tyre pressure of the newly mounted tyre as soon as possible.
- In vehicles fitted with a tyre pressure indicator, adjust the pressure and store the reading in the radio/Easy Connect system* »»  page 295.
- Have the tightening torque of the wheel bolts checked as soon as possible with a torque wrench (it should be 140 Nm). Meanwhile, drive carefully.
- Have the flat tyre replaced as quickly as possible.

Snow chains

Use

Snow chains should only be used on the *front* wheels.

Check that they are correctly seated after driving for a few yards; correct the position if necessary, in accordance with the manufacturer's fitting instructions. Keep your speed below 50 km/h (30 mph).

If there is a danger of being trapped despite having mounted the chains, it is best to disable the driving wheels (ASR) in the ESC »  page 174, **Switching on/off the ESC and ASR.**

Snow chains will improve *braking ability* as well as *traction* in winter conditions.

For technical reasons snow chains may only be used with the following wheel rim/tyre combination.

215/60 R16	Chains with links of maximum 15 mm
215/55 R17	Chains with links of maximum 15 mm
215/50 R18	Chains with links of maximum 15 mm
Other dimensions do not allow chains	

Remove any central wheel trims and the rim ring before fitting snow chains.

Remove the chains when roads are free of snow. Driving characteristics worsen, and the wheels become damaged quickly and may even be rendered unusable.

Emergency towing of the vehicle

Towing



Fig. 74 Right side of the front bumper: towline anchorage screwed in.

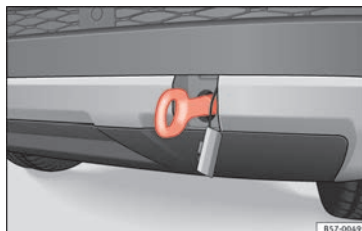



Fig. 75 Right side of the rear bumper: towline anchorage screwed in.

Towline anchorages

Attach the bar or rope to the towline anchorages.

The towline anchorages are located under the floor panel in the luggage compartment, next to the vehicle tools »  page 83.

Screw the towline anchorage into the screw connection » **Fig. 74** » **Fig. 75** and tighten it with the wheel brace.

Tow rope or tow bar

The tow bar offers increased safety and a lower risk of damage.

The tow rope is recommended when there is no tow bar. It must be elastic so that it does not damage the vehicle.

Notes for the driver of the towing vehicle

- The tow rope must be taut before you drive off.
- Release the clutch very carefully when starting the vehicle (manual gearbox), or accelerate gently (automatic gearbox).

Driving style

Towing requires some experience, especially when using a tow *rope*. Both drivers should realise how difficult it is to tow a vehicle. Inexperienced drivers should not attempt to tow.



Do not pull too hard with the towing vehicle and take care to avoid jerking the tow rope. When towing on an unpaved road, there is always a risk of overloading and damaging the anchorage points.

Switch on the ignition so that the turn signals, windscreen wipers and windscreen washer can work. Ensure that the steering wheel is unlocked and moves freely.

Place the gear lever in neutral on vehicles with a manual gearbox. With an automatic gearbox, place the lever in **N**.

To brake, press the brake pedal firmly. The brake servo does not work when the engine is switched off.

The power steering only works when the ignition is switched on and the vehicle is moving, provided that the battery is sufficiently charged. Otherwise, it will need more force.

Ensure that the tow rope remains taut at all times.



» » in Introduction on page 86



» » page 86

Tow-starting

If the engine will not start, first try starting it using the battery of another vehicle » » page 58. You should only attempt to tow-start a vehicle if charging the battery does not work. This is done by leveraging wheel movement.

When tow-starting a vehicle with a **petrol engine**, do not tow it more than a *short* distance, otherwise unburned fuel can enter the catalytic converter.

- Engage 2nd or 3rd gear before moving off.
- Press the clutch and hold the pedal down.
- Switch the ignition on.
- Once both vehicles are moving, release the clutch.
- As soon as the engine has started, press the clutch and move the gear lever to neutral.

How to jump start

Jump leads

The jump lead must have a sufficient wire cross section.

If the engine fails to start because of a discharged battery, the battery can be connected to the battery of another vehicle to start the engine.

Jump leads must comply with standard **DIN 72553** (see cable manufacturer's instructions). The wire cross section must be at least 25 mm² for petrol engines and at least 35 mm² for diesel engines.



Note

- **The vehicles must not touch each other, otherwise electricity could flow as soon as the positive terminals are connected.**
- **The discharged battery must be properly connected to the on-board network.**

How to jump start: description

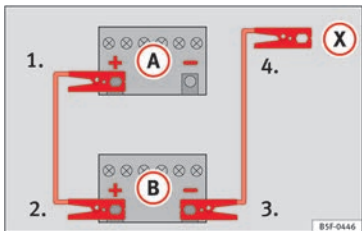


Fig. 76 Diagram of connections for vehicles without Start Stop system

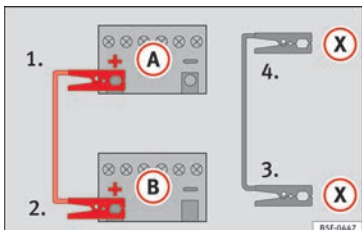


Fig. 77 Diagram of connections for vehicles with Start Stop system

Jump lead terminal connections

1. Switch off the ignition of both vehicles
» » ⚠.

2. Connect one end of the *red* jump lead to the positive (+) terminal of the vehicle with the flat battery (A) » » Fig. 76.
3. Connect the other end of the *red* jump lead to the positive terminal (+) in the vehicle providing assistance (B).
4. *For vehicles without Start-Stop system:* connect one end of the *black* jump lead to the negative terminal (-) of the vehicle providing the current (B) » » Fig. 76.
– *For vehicles with Start-Stop system:* connect one end of the *black* jump lead (X) to a suitable ground terminal, to a solid piece of metal in the engine block, or to the engine block itself » » Fig. 77.

5. Connect the other end of the *black* jump lead (X) to a solid metal component bolted to the engine block or to the engine block itself of the vehicle with the flat battery. Do not connect it to a point near the battery (A).
6. Position the leads in such a way that they cannot come into contact with any moving parts in the engine compartment.

Starting

7. Start the engine of the vehicle with the boosting battery and let it run at idling speed.

8. Start the engine of the vehicle with the flat battery and wait for 2 or 3 minutes until the engine is running.

Removing the jump leads

9. Before you remove the jump leads, switch off the dipped beam headlights if they are switched on.
10. Turn on the heater blower and heated rear window in the vehicle with the flat battery. This helps minimise voltage peaks which are generated when the leads are disconnected.
11. When the engine is running, disconnect the leads in reverse order to the details given above.

Make sure the battery clamps have sufficient metal-to-metal contact with the battery terminals.

If the engine fails to start after about 10 seconds, switch off the starter and try again after about 1 minute.

⚠ WARNING

- Please note the safety warnings referring to working in the engine compartment
» » 📖 page 282.
- The battery providing assistance must have the same voltage as the flat battery (12V) and approximately the same capacity (see imprint) » »

on battery). Failure to comply could result in an explosion.

- Never use jump leads when one of the batteries is frozen. Danger of explosion! Even after the battery has thawed, battery acid could leak and cause chemical burns. If a battery freezes, it should be replaced.
- Keep sparks, flames and lighted cigarettes away from batteries, danger of explosion. Failure to comply could result in an explosion.
- Observe the instructions provided by the manufacturer of the jump leads.
- Do not connect the negative cable from the other vehicle directly to the negative terminal of the flat battery. The gas emitted from the battery could be ignited by sparks. Danger of explosion.
- Do not attach the negative cable from the other vehicle to parts of the fuel system or to the brake line.
- The non-insulated parts of the battery clamps must not be allowed to touch. The jump lead attached to the positive battery terminal must not touch metal parts of the vehicle, this can cause a short circuit.
- Position the leads in such a way that they cannot come into contact with any moving parts in the engine compartment.
- Do not lean on the batteries. This could result in chemical burns.

Note

The vehicles must not touch each other, otherwise electricity could flow as soon as the positive terminals are connected.

screen wiper arms return to their initial position.



» page 85

Changing the wiper blades

Windscreen wipers service position

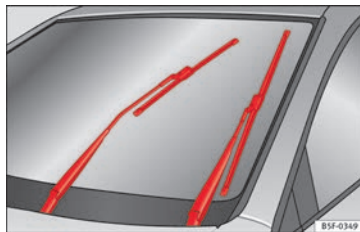


Fig. 78 Wipers in service position

The wiper arms can be raised when the wipers are in service position » Fig. 78.

- Close the bonnet » » page 282.
- Switch the ignition on and off.
- Press the windscreen wiper lever downwards briefly (4) » page 25.

Before driving, always lower the wiper arms. Using the windscreen wiper lever, the wind-

Changing the windscreen and rear window wiper blades

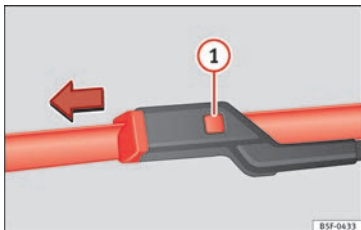


Fig. 79 Changing the windscreen wiper blades

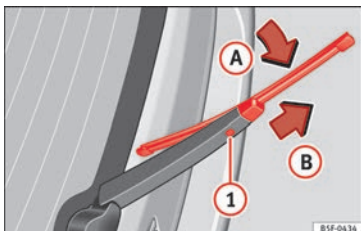


Fig. 80 Changing the rear wiper blade

Raising and lowering windscreen wiper arms

- Place the windscreen wipers in the service position » page 60.
- Grip the wiper arms **only** by the blade's fastening point.

Cleaning windscreen wiper blades

- Raise the wiper arms.
- Use a soft cloth to remove dust and dirt from the windscreen wiper blades.
- If the blades are very dirty, a sponge or damp cloth may be used » ❶ in Changing the windscreen and rear window wiper blades on page 86.

Changing the windscreen wiper blades

- Lift and unfold the wiper arms.
- Press and hold release button » Fig. 79 ❶ and pull gently on the wiper blade in the direction of the arrow.
- Fit a new wiper blade of the **same length and design** on to the wiper arm and hook it into place.
- Rest the wiper arms back onto the windscreen.

Changing the rear wiper blade

- Raising/lowering the wiper arm.
- Turn the blade slightly » Fig. 80 (arrow A).
- Hold down the release button ❶ while gently pulling the blade in the direction of arrow B.
- Insert a new blade of the **same length and type** in the rear wiper arm in the opposite direction to the arrow B and hook into place button ❶.

- Replace the wiper arm on the rear window.



» ⚠ in Changing the windscreen and rear window wiper blades on page 86



» page 85

Safety

Safe driving

Safety first!

WARNING

• This manual contains important information about the operation of the vehicle, both for the driver and the passengers. The other sections of the on-board documentation also contain further information that you should be aware of for your own safety and for the safety of your passengers.

• Ensure that the on-board documentation is kept in the vehicle at all times. This is especially important when lending or selling the vehicle to another person.

Advice about driving

Before starting every trip


For your own safety and the safety of your passengers, always note the following points before every trip:

- Make sure that the vehicle's lights and turn signals are working properly.
- Check tyre pressure.

- Ensure that all windows provide a clear and good view of the surroundings.
- Make sure all luggage is secured »» page 149.
- Make sure that no objects can interfere with the pedals.
- Adjust front seat, head restraint and mirrors properly according to your size.
- Ensure that the passengers in the rear seats always have the head restraints in the in-use position »» page 66.
- Instruct passengers to adjust the head restraints according to their height.
- Protect children with appropriate child seats and properly applied seat belts »» page 79.
- Assume the correct sitting position. Instruct your passengers also to assume a proper sitting position. »» page 63.
- Fasten your seat belt securely. Instruct your passengers also to fasten their seat belts properly. »» page 68.

What affects driving safety?

As a driver, you are responsible for yourself and your passengers. When your concentration or driving safety is affected by any cir-

cumstance, you endanger yourself as well as others on the road »» , for this reason:

- Always pay attention to traffic and do not get distracted by passengers or telephone calls.
- Never drive when your driving ability is impaired (e.g. by medication, alcohol, drugs).
- Observe traffic laws and speed limits.
- Always reduce your speed as appropriate for road, traffic and weather conditions.
- When travelling long distances, take breaks regularly - at least every two hours.
- If possible, avoid driving when you are tired or stressed.

WARNING

When driving safety is impaired during a trip, the risk of injury and accidents increases.

Safety equipment

Never put your safety or the safety of your passengers in danger. In the event of an accident, the safety equipment may reduce the risk of injury. The following list includes most of the safety equipment in your SEAT:

- Three-point seat belts
- belt tension limiters for the front and rear side seats,

- Belt tensioners for the front seats
- Front airbags
- knee airbags,
- Side airbags in the front seat backrests
- Head-protection airbags
- "ISOFIX" anchor points for child seats in the rear side seats with the "ISOFIX" system,
- Height-adjustable front head restraints
- Rear head restraints with in-use position and non-use position
- Adjustable steering column

The safety equipment mentioned above works together to provide you and your passengers with the best possible protection in the event of an accident. However, these safety systems can only be effective if you and your passengers are sitting in a correct position and use this equipment properly.

Safety is everyone's business!

Correct position for passengers

Correct sitting position for driver

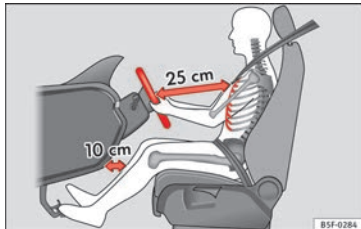


Fig. 81 The proper distance between driver and steering wheel

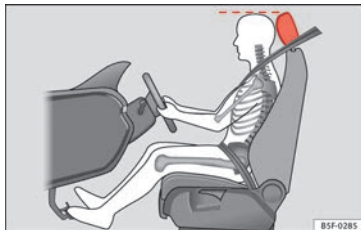


Fig. 82 Correct head restraint position for the driver.

For your own safety and to reduce the risk of injury in the event of an accident, we recom-

mend the following adjustments for the driver:

- Adjust the steering wheel so that there is a distance of at least 25 cm between the steering wheel and the centre of your chest » **Fig. 81.**
- Move the driver's seat forwards or backwards so that you are able to press the accelerator, brake and clutch pedals to the floor with your knees still slightly angled » **△.**
- Ensure that you can reach the highest point of the steering wheel.
- Adjust the head restraint so that its upper edge is at the same level as the top of your head, or as close as possible to the same level as the top of your head » **Fig. 82.**
- Move the seat backrest to an upright position so that your back rests completely against it.
- Fasten your seat belt securely » **page 68.**
- Keep both feet in the footwell so that you have the vehicle under control at all times.

Adjustment of the driver's seat » **page 143.**

⚠ WARNING

- An incorrect sitting position of the driver can lead to severe injuries.

- Adjust the driver's seat so that there is at least 25 cm distance between the centre of the chest and the centre of the steering wheel » Fig. 81. If you are sitting closer than 25 cm, the airbag system cannot protect you properly.
- If your physical constitution prevents you from maintaining the minimum distance of 25 cm, contact a specialised workshop. The workshop will help you decide if special specific modifications are necessary.
- When driving, always hold the steering wheel with both hands on the outside of the ring at the 9 o'clock and 3 o'clock positions. This reduces the risk of injury when the driver airbag is triggered.
- Never hold the steering wheel at the 12 o'clock position, or in any other manner (e.g. in the centre of the steering wheel). In such cases, if the airbag is triggered, you may sustain injuries to the arms, hands and head.
- To reduce the risk of injury to the driver during sudden braking manoeuvres or an accident, never drive with the backrest tilted far back! The airbag system and seat belts can only provide optimal protection when the backrest is in an upright position and the driver is wearing his or her seat belt correctly.
- Adjust the head restraint properly to achieve optimal protection.

Adjusting the steering wheel position

Read the additional information carefully


»  page 14.

WARNING

- Never adjust the position of the steering wheel when the vehicle is moving, as this could cause an accident.
- Move the lever up firmly so the steering wheel position does not accidentally change during driving. risk of accident!
- Make sure you are capable of reaching and firmly holding the upper part of the steering wheel: risk of accident!
- If you adjust the steering wheel so that it points towards your face, the driver airbag will not protect you properly in the event of an accident. Make sure that the steering wheel points towards your chest.

Correct sitting position for front passenger

For your own safety and to reduce the risk of injury in the event of an accident, we recommend the following adjustments for the front passenger:

- Move the front passenger seat back as far as possible » .

- Move the seat backrest to an upright position so that your back rests completely against it.
- Adjust the head restraint so that its upper edge is at the same level as the top of your head, or as close as possible to the same level as the top of your head » page 66.
- Always keep both feet in the footwell in front of the front passenger seat.
- Fasten your seat belt securely » page 68.

It is possible to deactivate the front passenger airbag in **exceptional circumstances** » page 77.

Adjusting the front passenger seat » page 143.

WARNING

- An incorrect sitting position of the front passenger can lead to severe injuries.
- Adjust the front passenger seat so that there is at least 25 cm between your chest and the dash panel. If you are sitting closer than 25 cm, the airbag system cannot protect you properly.
- If your physical constitution prevents you from maintaining the minimum distance of 25 cm, contact a specialised workshop. The workshop will help you decide if special specific modifications are necessary.

• Always keep your feet in the footwell when the vehicle is moving; never rest them on the dash panel, out the window or on the seat. An incorrect sitting position exposes you to an increased risk of injury in case of a sudden braking or an accident. If the airbag is triggered, you could sustain severe injuries due to an incorrect sitting position.

• To reduce the risk of injury to the front passenger in events such as sudden braking manoeuvres or an accident, never travel with the backrest tilted far back! The airbag system and seat belts can only provide optimal protection when the backrest is in an upright position and the front passenger is wearing his or her seat belt properly. The further the seat backrests are tilted to the rear, the greater the risk of injury due to incorrect positioning of the belt web or to the incorrect sitting position!

• Adjust the head restraint correctly in order to achieve maximum protection.

Correct sitting position for rear seat passengers

To reduce the risk of injury in the event of a sudden braking manoeuvre or an accident, passengers on the rear seat bench must consider the following:

- Sit up straight.
- Adjust the head restraint to the correct position » page 66.


- Always keep both feet in the footwell in front of the rear seat.
- Fasten your seat belt securely » page 68.
- Use an appropriate child restraint system when you take children in the vehicle » page 79.

WARNING

- If the passengers in the rear seats are not sitting properly, they could sustain severe injuries.
- Adjust the head restraint correctly in order to achieve maximum protection.
- Seat belts can only provide optimal protection when seat backrests are in an upright position and the vehicle occupants are wearing their seat belts correctly. If passengers in the rear seats are not sitting in an upright position, the risk of injury due to incorrect positioning of the seat belt increases.

Examples of incorrect sitting positions

Seat belts can provide optimal protection only when the belt webs are properly positioned. Incorrect sitting positions substantially reduce the protective function of seat belts and increase the risk of injury due to incorrect seat belt position. As the driver, you are responsible for all passengers, especially children.

- Never allow anyone to assume an incorrect sitting position in the vehicle while travelling » .

The following list contains examples of sitting positions that could be dangerous for all vehicle occupants. The list is not complete, but we would like to make you aware of this issue.

Therefore, whenever the vehicle is in motion:

- Never stand in the vehicle.
- Never stand on the seats.
- Never kneel on the seats.
- Never tilt your seat backrest far to the rear.
- Never lean against the dash panel.
- Never lie on the rear bench.
- Never sit on the front edge of a seat.
- Never sit sideways.
- Never lean out of a window.
- Never put your feet out of a window.
- Never put your feet on the dash panel.
- Never put your feet on the surface of a seat.
- Do not allow anyone to travel in the footwell.
- Never travel without wearing the seat belt.
- Do not allow anyone to travel in the luggage compartment.

»

⚠ WARNING

- Any incorrect sitting position increases the risk of severe injuries. Sitting in an incorrect position exposes the vehicle occupants to severe injuries if airbags are triggered, by striking a vehicle occupant who has assumed an incorrect sitting position.
- Before the vehicle moves, assume the proper sitting position and maintain it throughout the trip. Before every trip, instruct your passengers to sit properly and to stay in this position during the trip »» page 63, Correct position for passengers.

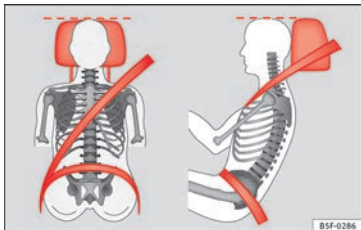
Correct adjustment of front head restraints

Fig. 83 Correctly adjusted head restraint as viewed from the front and the side.

Read the additional information carefully »» page 13.

Properly adjusted head restraints are an important part of passenger protection and can reduce the risk of injuries in most accident situations.

- Adjust the head restraint so that its upper edge is, as far as possible, at the same level as the top of your head, or at the very least, at eye level »» **Fig. 83**.

⚠ WARNING

- Travelling with the head restraints removed or improperly adjusted increases the risk of severe injuries. An improper adjustment of the head restraints may cause death in an accident and increase the risk of suffering injuries during abrupt braking actions or unexpected manoeuvres.
- The head restraints must always be adjusted according to the height of the passenger.

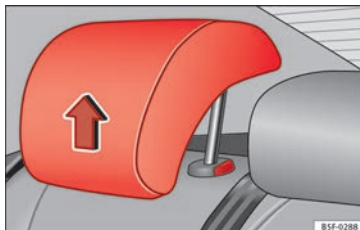
Correct adjustment of rear head restraints

Fig. 84 Head restraints in the correct position.



Fig. 85 Head restraint position warning label.

Properly adjusted head restraints are an important part of the passenger protection and can reduce the risk of injuries in most accident situations

Rear head restraints

- The rear head restraints have 2 positions: **use** and **non-use**.
- One position for **use** (head restraint raised)
 - » **Fig. 84**. In this position, the head restraints are used normally, protecting passengers along with the rear seat belts.
- And one position for **non-use** (head restraint lowered).
- To fit the head restraints in position for use, pull on the edges with both hands in the direction of the arrow.

WARNING


- **Under no circumstances should the rear passengers travel while the head restraints are in the non-use position. See the warning label located on the rear side fixed window » Fig. 85.**
- **Do not swap the centre rear head restraint with either of the outer seat rear head restraints. Risk of injury in case of an accident!**

CAUTION

Note the instructions on the adjustment of the head restraints » page 143.

Pedal area

Pedals

- Ensure that you can always press the accelerator, brake and clutch pedals unimpaird to the floor.
- Ensure that the pedals can return unimpaird to their initial positions.
- Ensure that the floor mats are securely fastened during the trip and do not obstruct the pedals » .

Only use floor mats which leave the pedals clear and which are secured to prevent them from slipping. You can obtain suitable floor mats from a specialised dealership. Fasteners* for floor mats are fitted in the footwells.

If a brake circuit fails, the brake pedal must be pressed down thoroughly in order to stop the vehicle.

Wear suitable footwear

Always wear shoes which support your feet properly and give you a good feeling for the pedals.

WARNING

- **Restricting pedal operation can lead to critical situations while driving.**

• **Never lay or fit floor mats or other floor coverings over the original floor mats. This would reduce the pedal area and could obstruct the pedals. Risk of accident.**

• **Never place objects in the driver footwell. An object could move into the pedal area and impair pedal operation. In the event of a sudden driving or braking manoeuvre, you will not be able to operate the brake, clutch or accelerator pedal. Risk of accident!**

Seat belts

Why wear a seat belt?

Number of seats

Your vehicle has **five** seats, two in the front and three in the rear. Each seat is equipped with a three-point seat belt.

In some versions, your vehicle is approved **only** for four seats. Two front seats and two rear seats.

WARNING

- Never transport more than the permitted amount of people in your vehicle.
- Every vehicle occupant must properly fasten and wear the seat belt belonging to his or her seat. Children must be protected with an appropriate child restraint system.

Seat belt lamp*




Fig. 86 Instrument panel: right rear seat occupied and corresponding seat belt fastened display.


The control lamp illuminates to remind the driver to fasten his seat belt.


Before starting the vehicle:

- Fasten your seat belt securely.
- Instruct your passengers to fasten their seat belts properly before driving off.
- Protect children by using a child seat according to the child's height and weight.



When the ignition is switched on, the control lamp  in the instrument panel lights up (depending on the model version) if the driver or passenger have not fastened their seat belts.

An audible warning signal will sound for a few seconds if the seat belts are not fastened as the vehicle drives off and reaches a speed

of more than approximately 25 km/h (15 mph) or if the seat belts are unfastened while the vehicle is in motion. The warning light will also flash .

The  lamp goes out when the driver and passenger seat belts are fastened with the ignition switched on.

Rear seat belts fastened display.*

Depending on the model version, when the ignition is switched on, the seat belt status display  **Fig. 86** on the instrument panel informs the driver whether the passengers in the rear seats have fastened their seat belts. The  symbol indicates that the passenger in this seat has fastened “his or her” seat belt.

When a seat belt in the rear seats is fastened or unfastened, the seat belt status is displayed for approximately 30 seconds. The indication can be hidden by pressing the **(0.0/SET)** button on the dash panel.

The seat belt status flashes for a maximum of 30 seconds when a seat belt in the rear seats is unfastened while the vehicle is in motion. An audible warning will also be heard if the vehicle is travelling at over 25 km/h (15 mph).

The protective function of seat belts



Fig. 87 Drivers with properly worn seat belts will not be thrown forward in the event of sudden braking

Properly worn seat belts hold the occupants in the proper position. They also help prevent uncontrolled movements that may result in serious injury and reduce the risk of being thrown out of the vehicle in case of an accident.

Vehicle occupants wearing their seat belts correctly benefit greatly from the ability of the belts to absorb kinetic energy. In addition, the front part of your vehicle and other passive safety features (such as the airbag system) are designed to absorb the kinetic energy released in a collision. Taken together, all these features reduce the releasing kinetic energy and consequently, the risk of injury. This is why it is so important to fasten seat belts before every trip, even when "just driving around the corner".

Ensure that your passengers wear their seat belts as well. Accident statistics have shown that wearing seat belts is an effective means of substantially reducing the risk of injury and improving the chances of survival when involved in a serious accident. Furthermore, properly worn seat belts improve the protection provided by airbags in the event of an accident. For this reason, wearing a seat belt is required by law in most countries.

Although your vehicle is equipped with airbags, the seat belts must be fastened and worn. The front airbags, for example, are only triggered in some cases of head-on collision. The front airbags will not be triggered during minor frontal or side collisions, rear-end collisions, rollovers or accidents in which the airbag trigger threshold value in the control unit is not exceeded.

Therefore, you should always wear your seat belt and ensure that all vehicle occupants have fastened their seat belts properly before you drive off!

Safety instructions on using seat belts

- Always wear the seat belt as described in this section.
- Ensure that the seat belts can be fastened at all times and are not damaged.

⚠ WARNING

- If seat belts are worn incorrectly or not at all, the risk of severe injuries increases. The optimal protection from seat belts can be achieved only if you use them properly.
- Fasten your seat belt before every trip - even when driving in town. Other vehicle occupants must also wear the seat belts at all times, otherwise they run the risk of being injured.
- The seat belt cannot offer its full protection if the seat belt is not positioned correctly.
- Never allow two passengers (even children) to share the same seat belt.
- Always keep both feet in the footwell in front of your seat as long as the vehicle is in motion.
- Never unbuckle a seat belt while the vehicle is in motion. Risk of fatal injury.
- The seat belt must never be twisted while it is being worn.
- The seat belt should never lie on hard or fragile objects (such as glasses or pens, etc.) because this can cause injuries.
- Do not allow the seat belt to be damaged or jammed, or to rub on any sharp edges.
- Never wear the seat belt under the arm or in any other incorrect position.
- Loose, bulky clothing (such as an overcoat over a jacket) impairs the proper fit and function of the seat belts, reducing their capacity to protect.

- The slot in the seat belt buckle must not be blocked with paper or other objects, as this can prevent the latch plate from engaging securely.
- Never use seat belt clips, fastening rings or similar items to alter the position of the belt webbing.
- Frayed or torn seat belts or damage to the connections, belt retractors or parts of the buckle could cause severe injuries in the event of an accident. Therefore, you must check the condition of all seat belts at regular intervals.
- Seat belts which have been worn in an accident and stretched must be replaced by a specialised workshop. Renewal may be necessary even if there is no apparent damage. The belt anchorage should also be checked.
- Do not attempt to repair a damaged seat belt yourself. The seat belts must not be removed or modified in any way.
- The belts must be kept clean, otherwise the retractors may not work properly.

Head-on collisions and the laws of physics



Fig. 88 A driver not wearing a seat belt is thrown forward violently



Fig. 89 The unbelted passenger in the rear seat is thrown forward violently, hitting the driver who is wearing a seat belt.

It is easy to explain how the laws of physics work in the case of a head-on collision: when a vehicle starts moving, a type of energy

called “kinetic energy” is created both in the passengers and inside the vehicle.

The amount of “kinetic energy” depends on the speed of the vehicle and the weight of the vehicle and its passengers. The higher they are, the more energy there is to be “absorbed” in the event of an accident.

The most significant factor, however, is the speed of the vehicle. If the speed doubles from 25 km/h (15 mph) to 50 km/h (30 mph), for example, the corresponding kinetic energy is multiplied by four.

Given that the passengers of the vehicle in our example do not have their seat belts fastened, in the event of a collision the entire amount of the passengers' kinetic energy will be only absorbed by the mentioned impact.

Even at speeds of 30 km/h (19 mph) to 50 km/h (30 mph), the forces acting on bodies in a collision can easily exceed one tonne (1000 kg). At greater speed these forces are even higher.

Vehicle occupants not wearing seat belts are not “attached” to the vehicle. In a head-on collision, they will move forward at the same speed their vehicle was travelling just before the impact. This example applies not only to head-on collisions, but to all accidents and collisions.

Even at low speeds the forces acting on the body in a collision are so great that it is not

possible to brace oneself with one's hands. In a frontal collision, unbelted passengers are thrown forward and will make violent contact with the steering wheel, dash panel, windscreen or whatever else is in the way » **Fig. 88.**

It is also important for rear passengers to wear seat belts properly, as they could otherwise be thrown forward violently through the vehicle interior in an accident. Passengers in the rear seats who do not use seat belts endanger not only themselves but also the front occupants » **Fig. 89.**

How to properly adjust your seatbelt

Fastening and unfastening the seat belt

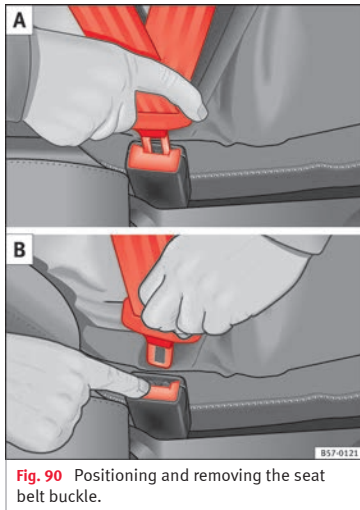



Fig. 90 Positioning and removing the seat belt buckle.



Fig. 91 Position of seat belt during pregnancy.

Read the additional information carefully »  page 13.

Fasten your seat belt


The seat belt cannot offer its full protection if the seat belt is not positioned correctly.

- Adjust the seat and head restraint correctly.
- To fasten the belt, take hold of the latch plate and pull it slowly across your chest and lap.
- Insert the latch plate into the buckle for the appropriate seat and push it down until it is securely locked with an audible click » **Fig. 90 A.**
- Pull the belt to ensure that the latch plate is securely engaged in the buckle. »

The seat belts are equipped with an automatic retractor on the shoulder strap. Full freedom of movement is permitted when the shoulder belt is pulled slowly. However, during sudden braking, during travel in steep areas or bends and during acceleration, the automatic retractor on the shoulder belt is locked.

The automatic belt retractors on the front seats are fitted with seat belt tensioners » page 72.

Releasing the seat belt

- Press the red button on the belt buckle » Fig. 90 B. The latch plate is released and springs out » .
- Guide the belt back by hand so that it rolls up easily and the trim is not damaged.

Positioning seat belts

Seat belts offer their maximum protection only when they are properly positioned.


WARNING

- **The seat belts offer best protection only when the backrests are in an upright position and the seat belts have been fastened properly.**
- **Never put the latch plate in the buckle of another seat. If you do this, the seat belt will not protect you properly and the risk of injury is increased.**

- **Never unbuckle a seat belt while the vehicle is in motion. If you do, you increase the risk of sustaining severe or fatal injuries.**
- **An incorrectly worn seat belt can cause severe injuries in the event of an accident.**
- **For pregnant women, the lap part of the seat belt must lie as low as possible over the pelvis, never across the stomach, and always lie flat so that no pressure is exerted on the abdomen » Fig. 91.**
- **Always engage the retractor lock when you are securing a child seat in group 0, 0+ or 1 » page 79.**
- **Read and observe the warnings » page 69.**

Seat belt tensioners

How the seat belt tensioner works

Read the additional information carefully »  page 14.

The seat belts for the occupants in the front seats are equipped with belt tensioners. Sensors will trigger the belt tensioners only during severe head-on, lateral and rear-end collisions and only if the seat belt is worn. This retracts and tightens the seat belts, reducing the forward motion of the occupants.

The belt tensioners will not be triggered in the event of minor collisions, if the vehicle

overturns, or in accidents where no major forces act on the vehicle.

Note

- **If the seat belt tensioners are triggered, a fine dust is produced. This is normal and it is not an indication of fire in the vehicle.**
- **The relevant safety requirements must be observed when the vehicle or components of the system are scrapped. Specialised workshops are familiar with these regulations, which are also available to you.**

Service and disposal of belt tensioners

The belt tensioners are components of the seat belts that are installed in the seats of your vehicle. If you work on the belt tensioners or remove and install parts of the system when performing other repair work, the seat belt may be damaged. The consequence may be that, in the event of an accident, the belt tensioners function incorrectly or may not function at all.

So that the effectiveness of the seat belt tensioner is not reduced and that removed parts do not cause any injuries or environmental pollution, regulations, which are known to the specialised workshops, must be observed.

⚠ WARNING

- Improper use or repairs not carried out by qualified mechanics increase the risk of severe or fatal injuries. The belt tensioners may fail to trigger or may trigger in the wrong circumstances.
- Never attempt to repair, adjust, remove or install parts of the belt tensioners or seat belts.
- The seat belt tensioner, seat belt and automatic retractor cannot be repaired.
- Any work on the belt tensioners and seat belts, including the removal and refitting of system parts in conjunction with other repair work, must be performed by a specialised workshop only.
- The belt tensioners will only provide protection for one accident and must be changed if they have been activated.

Airbag system

Brief introduction

Why is it so important to wear a seat belt and to sit correctly?

For the inflating airbags to achieve the best protection, the seat belt must always be worn properly and the correct sitting position must be assumed.

The airbag system is not a substitute for seat belts, but it is an integral part of the vehicle's overall passive safety system. Please bear in mind that the airbag system can only work effectively when the vehicle occupants are wearing their seat belts correctly and have adjusted the head restraints properly. Therefore, it is most important to properly wear the seat belts at all times, not only because this is required by law in most countries, but also for your safety »» page 68, **Why wear a seat belt?**.

The airbag inflates in a matter of seconds, so if you are not properly seated when the airbag is triggered, you may sustain fatal injuries. Therefore, it is essential that all vehicle occupants assume a correct sitting position while travelling.

Sharp braking before an accident may cause a passenger not wearing a seat belt to be thrown forward into the area of the deploying

airbag. In this case, the inflating airbag may inflict critical or fatal injuries on the occupant. This also applies to children.

Always maintain the greatest possible distance between yourself and the front airbag. This way, the front airbags can completely deploy when triggered, providing their maximum protection.

The most important factors that will trigger an airbag are: the type of accident, the angle of collision and the speed of the vehicle.

Whether or not the airbags are triggered depends primarily on the vehicle deceleration rate resulting from the collision and detected by the control unit. If the vehicle deceleration occurring during the collision and measured by the control unit remains below the specified reference values, the front, side and/or curtain airbags will not be triggered. Take into account that the visible damage in a vehicle involved in an accident, no matter how serious, is not a determining factor for the airbags to have been triggered.

⚠ WARNING

- **Wearing the seat belt incorrectly or assuming an incorrect sitting position can lead to critical or fatal injuries.**
- **All vehicle occupants, including children, who are not properly belted can sustain critical or fatal injuries if the airbag is triggered. Children up to 12 years old should always**




travel on the rear seat. Never transport children in the vehicle if they are not restrained or the restraint system is not appropriate for their age, size or weight.

- If you are not wearing a seat belt, or if you lean forward or to the side while travelling or assume an incorrect sitting position, there is a substantially increased risk of injury. This increased risk of injury will be further increased if you are struck by an inflating airbag.

- To reduce the risk of injury from an inflating airbag, always wear the seat belt properly »» page 68.

- Always adjust the front seats properly.


Description of the airbag system

Read the additional information carefully »»  page 15.


The airbag system is not a substitute for the seat belts. The airbag system offers additional protection for the driver and passenger in combination with the seat belts.

The airbag system comprises the following modules (as per vehicle equipment):

- Electronic control unit
- Front airbags for driver and passenger
- Knee airbag for the driver
- Side airbags

- Head airbag
- Airbag control lamp  on the instrument panel
- Key-operated switch for front passenger airbag
- Control lamp to disconnect/connect the front airbag.

The airbag system operation is monitored electronically. The airbag control lamp will illuminate for a few seconds every time the ignition is switched on (self-diagnosis).

There is a fault in the system if the control lamp :

- does not light up when the ignition is switched on,
- turns off after 4 seconds after the ignition is switched on
- turns off and then lights up again after the ignition is switched on
- illuminates or flashes while the vehicle is moving.

The airbag system is not triggered if:

- the ignition is switched off
- there is a minor frontal collision
- there is a minor side collision
- there is a rear-end collision
- the vehicle turns over.

WARNING

- The seat belts and airbags can only provide maximum protection if the occupants are seated correctly »» page 63, Correct position for passengers.
- If a fault has occurred in the airbag system, have the system checked immediately by a specialised workshop. Otherwise there is a danger that during a collision, the system may fail to trigger, or not trigger correctly.

Airbag activation

The airbags deploy extremely rapidly, within thousandths of a second, to provide additional protection in the event of an accident. A fine dust may develop when the airbag deploys. This is normal and it is not an indication of fire in the vehicle.

The airbag system is only ready to function when the ignition is on.

In special accidents instances, several airbags may activate at the same time.

In the event of minor head-on and side collisions, rear-end collisions, overturning or roll-over of the vehicle, airbags **do not activate**.

Activation factors

The conditions that lead to the airbag system activating in each situation cannot be generalised. Some factors play an important role,

such as the properties of the object the vehicle hits (hard/soft), angle of impact, vehicle speed, etc.

Deceleration trajectory is key for airbag activation.

The control unit analyses the collision trajectory and activates the respective restraint system.

If the deceleration rate is below the predefined reference value in the control unit the airbags will not be triggered, even though the accident may cause extensive damage to the car.

The following airbags are triggered in serious head-on collisions

- Driver airbag.
- Front passenger front airbag
- Knee airbag for the driver.

The following airbags are triggered in serious side-on collisions


- Front side airbag on the side of the accident.
- Rear side airbag on the side of the accident.
- Curtain (head) airbag on the side of the accident.

In an accident with airbag activation:

- the interior lights switch on (if the interior light switch is in the courtesy light position);
- the hazard warning lights switch on;
- all doors are unlocked;
- the fuel supply to the engine is cut.

Airbag safety instructions


Front airbags

Read the additional information carefully
»»  page 15.

WARNING

- The deployment space between the front passengers and the airbags must not in any case be occupied by other passenger, pets and objects.
- The airbags provide protection for just one accident; replace them once they have deployed.
- It is also important not to attach any objects such as cup holders or telephone mountings to the surfaces covering the airbag units.
- Do not attempt to modify components of the airbag system in any way.


Knee airbag*

Read the additional information carefully
»»  page 16.

WARNING

- The knee airbag is deployed in front of the driver's knees. Always keep the deployment areas of the knee airbags free.
- Never not fix objects to the cover or in the deployment area of the knee airbag.
- Adjust the driver's seat so that there is a distance of at least 10 cm (4 inches) between your knees and the location of the this airbag. If your physical constitution prevents you from meeting these requirements, make sure you contact a specialised workshop.

Side airbags*

Read the additional information carefully
»»  page 16.

WARNING

- If you do not wear a seat belt, if you lean forward, or are not seated correctly while the vehicle is in motion, you are at a greater risk of injury if the side airbag system is triggered in an accident.
- In order for the side airbags to provide their maximum protection, the prescribed sitting »»

position must always be maintained with seat belts fastened while travelling.

- In a side-on collision the side airbags will not work if the sensors do not correctly measure the pressure increase on the interior of the doors, due to air escaping through the areas with holes or openings in the door panel.
- Never drive if the interior door panels have been removed or if the panels have not been correctly fitted.
- Never drive the vehicle if the loudspeakers in the door panels have been removed, unless the holes left by the loudspeakers have been closed properly.
- Always check that the openings are closed or covered if loudspeakers or other equipment are fitted inside the door panels.
- Occupants of the outer seats must never carry any objects or pets in the deployment space between them and the airbags, or allow children or other passengers to travel in this position. It is also important not to attach any accessories (such as cup holders) to the doors. This would impair the protection offered by the side airbags.
- The built-in coat hooks should be used only for lightweight clothing. Do not leave any heavy or sharp-edged objects in the pockets.
- Great forces, such as hard blows or kicks, must not be exerted upon the backrest bolster because the system may be damaged. In this case, the side airbags would not be triggered.

- Under no circumstances should protective covers be fitted over seats with side airbags unless the covers have been approved for use in your vehicle. Because the airbag deploys from the side of the backrest, the use of conventional seat covers would obstruct the side airbag, seriously reducing the airbag's effectiveness.
- Any damage to the original seat upholstery or around the seams of the side airbag units must be repaired immediately by a specialised workshop.
- The airbags provide protection for just one accident; replace them once they have deployed.
- Any work on the side airbag system or removal and installation of the airbag components for other repairs (such as removal of the front seat) should only be performed by a specialised workshop. Otherwise, faults may occur during the airbag system operation.
- Do not attempt to modify components of the airbag system in any way.

Curtain airbags*

Read the additional information carefully

»  page 17.

WARNING

- In order for the head-protection airbags to provide their maximum protection, the pre-

scribed sitting position must always be maintained with seat belts fastened while travelling.

- For safety reasons, the curtain airbag must be disabled in those vehicles fitted with a screen dividing the interior of the vehicle. See your technical service to make this adjustment.
- There must be no other persons, animals or objects between the occupants of the outer seats and the deployment space of the head-protection airbags so that the head-protection airbag can deploy completely without restriction and provide the greatest possible protection. Therefore, sun blinds which have not been expressly approved for use in your vehicle may not be attached to the side windows
- The built-in coat hooks should be used only for lightweight clothing. Do not leave any heavy or sharp-edged objects in the pockets. Please, do not hang the clothes on coat hangers.
- The airbags provide protection for just one accident; replace them once they have deployed.
- Any work on the head-protection airbag system or removal and installation of the airbag components for other repairs (such as removal of the roof lining) should only be performed by a specialised workshop. Otherwise, faults may occur during the airbag system operation.
- Do not attempt to modify components of the airbag system in any way.




- The side and head airbags are managed through sensors located in the interior of the front doors. To ensure the correct operation of the side and curtain airbags neither the doors nor the door panels should be modified in any way (e.g. fitting loudspeakers). If the front door is damaged, the airbag system may not work correctly. All work carried out on the front door must be done in a specialised workshop.

Deactivating airbags




Deactivation of front airbag



Fig. 92 Control lamp for disabling the front passenger front airbag on the dash panel

	It lights up on the combi-instrument
Fault in airbag system and seat belt tensioners.	Have the system checked immediately by a specialised workshop.
OFF 	It lights up on the dash panel
Fault in the airbag system.	Have the system checked immediately by a specialised workshop.
Front passenger front airbag disabled.	Check whether the airbag should remain disabled.
ON 	It lights up on the dash panel
Front passenger front airbag enabled.	The control lamp switches off about 60 seconds after the ignition is turned on or after enabling of the front passenger front airbag with the key lock switch.

Several warning and control lamps light up for a few seconds when the ignition is switched on, signalling that the function is being verified. They will switch off after a few seconds.

If the front passenger airbag is deactivated, the lamp **PASSENGER AIR BAG OFF**  **does not remain lit**, or if it is lit together with the control lamp  on the dash panel, there may be a fault in the airbag system **»** .

The disabling of airbags is only carried out in certain cases, i.e. if:

- a child seat is required in the front passenger seat with the child facing in the opposite direction to the direction of travel (in some countries, due to divergent legal requirements, facing in the direction of travel) **»** page 80;
- despite the driver's seat being in the correct position, a minimum distance of 25 cm cannot be maintained between the centre of the steering wheel and the driver's torso,
- installation of special devices is required in the steering wheel area due to a physical disability,
- if you have special seats installed (e.g. an orthopaedic seat without side airbags).


The front passenger front airbag can be disabled using the switch **»** page 78.

We recommend that you contact an authorised SEAT dealer for the disabling of other airbags.




Airbag system control

The airbag system availability is controlled electronically, regardless of whether an airbag is disabled.

If an airbag was disabled using a diagnostics system:

- the airbag system warning lamp  illuminates after switching on the ignition for about 4 seconds, and then flashes for about 12 seconds.

If the airbag has been disabled with the airbag switch on the side of the dash panel:

- the airbag control lamp  will illuminate for about 4 seconds after the ignition is switched on,
- The airbag is disabled, signalled with the warning lamp **OFF**  which lights up with the word **PASSENGER AIR BAG OFF**  placed in the centre part of the dash panel **»» Fig. 93.**

WARNING

In the event of a fault in the airbag system, the airbag may not trigger correctly, may fail to trigger or may even trigger unexpectedly, leading to severe or fatal injuries.

- Have the airbag system checked immediately by a specialised workshop.
- Never mount a child seat in the front passenger seat or remove the mounted child seat! The front passenger front airbag may deploy during an accident in spite of the fault.

CAUTION

Always pay attention to any lit control lamps and to the corresponding descriptions and instructions to avoid damage to the vehicle.

Note

- Follow the current legislation in your country regarding the disabling of airbags.
- At your authorised SEAT dealer you can find information on which vehicle airbags can be disabled.

Front passenger front airbag switch



Fig. 93 Front passenger front airbag switch.




Fig. 94 Warning lamp for disabling the front passenger airbag.


Read the additional information carefully

»»  page 15.

The switch disables only the front passenger front airbag.

Switching on the airbag


- Switch the ignition off.
- Open the front passenger door.
- Insert the key into the slot of the switch for deactivating the front passenger airbag **»» Fig. 93.** About 3/4 of the key should enter, as far as it will go.
- Then turn the key gently to the **ON** position. Do not force it if you feel resistance, and make sure you have inserted the key fully.
- Close the front passenger door.
- Check, with the ignition switched on, that the control lamp **OFF**  **»» Fig. 94** does not

light up, with the word **PASSENGER AIR BAG OFF**  in the centre part of the dash panel.


- The warning lamp **ON**  is illuminated for 60 seconds in the centre part of the dash panel.

Control lamp with the word **PASSENGER AIR BAG OFF** (front passenger airbag disabled)

If the front passenger front airbag is **disabled**, after switching on the ignition, the control lamp will light up for several seconds, then it will switch off for about 1 s and then switch on again.

If the control lamp is flashing, there is a fault in the disabling of the airbag system **»** . **Please go immediately to an Official Service.**

WARNING

- **The driver of the vehicle is responsible for disabling or switching on the airbag.**
- **Always switch off the ignition before disabling the front passenger airbag! Failure to do so could result in a fault in the airbag deactivation system.**
- **Never leave the key in the airbag disabling switch as it could get damaged or enable or disable the airbag during driving.**
- **If the OFF  (airbag disabled) control lamp flashes, the front passenger front airbag will not trigger in the event of an accident! Have the system immediately checked by an Official Service.**

Transporting children safely

Safety for children

Introduction

For safety reasons, as we have learned from accident statistics, we recommend that children under 12 years of age travel in the rear seats. Depending on their age, height and weight, children travelling in rear seats must use a child seat or a seat belt. For safety reasons, the child seat should be installed in the rear seat, behind the front passenger seat or in the centre back seat.

The physical laws involved and the forces acting in a collision apply also to children **»** page 70. But unlike adults, children do not have fully developed muscle and bone structures. This means that children are subject to a greater risk of injury.

To reduce the risk of injuries, children must always use special child restraint systems when travelling in the vehicle.

We recommend the use of child safety products from the SEAT Original Accessories Programme, which includes systems for all ages made by “Peke” (not for all countries) (see www.seat.com).

These systems have been especially designed and approved, complying with the ECE-R44. regulation.

SEAT recommends securing the child seats shown on the website as described below:

- Child seats in the opposite direction of travel (group 0+): ISOFIX and support bracket (Peke G0 Plus + ISOFIX Base (RWF)).
- Child seats in the direction of travel (group 1): ISOFIX and Top Tether (Peke G1 ISOFIX DUO Plus).
- Child seats in the direction of travel (group 2): seat belt and ISOFIX (Peke G3 KIDFIX).
- Child seats in the direction of travel (group 3): with seat belt (Peke G3 KIDFIX).

Follow the manufacturer's instructions and observe any statutory requirements when installing and using child seats. Always read and note **»** page 79.


We recommend you always carry the manufacturer's Child Seat Instruction Manual together with the on-board documentation.

Important information regarding the front passenger's airbag

Read the additional information carefully

»  page 17. **»**

Read and always observe the safety information included in the following chapters:

- Safety distance with respect to the passenger airbag » page 73.
- Objects between the passenger and the passenger side airbag »  in Front airbags on page 75.

The passenger side front airbag, when enabled, is a serious risk for a child that is facing backward since the airbag can strike the seat with such force that it can cause serious or fatal injuries. Children up to 12 years old should always travel on the rear seat.

Therefore we strongly recommend you to transport children on the rear seats. This is the safest location in the vehicle. Alternatively, the front passenger airbag can be disabled with a key-operated switch » page 78. When transporting children, use a child seat suitable for the age and size of each child » page 81.

WARNING

- If a child seat is secured to the front passenger seat, the risk to the child of sustaining critical or fatal injuries in the event of an accident increases.
- An inflating front passenger airbag can strike the rear-facing child seat and project it with great force against the door, the roof or the backrest.


- **Never install a child seat facing backwards on the front passenger seat unless the front passenger front airbag has been disabled. Risk of potentially fatal injuries to the child! However, if it is necessary, in exceptional cases, to transport a child in the front passenger seat, the front passenger front airbag must always be disabled » page 77. If the passenger seat has a height adjustment option, move it to the highest, most upright position. If you have a fixed seat, do not install any child restraint system in this location.**
- For those vehicles that do not include a key lock switch to deactivate the airbag, the vehicle must be taken to a technical service. Do not forget to reconnect the airbag when an adult wants to sit in the front passenger seat.
- All vehicle occupants, especially children, must assume the proper sitting position and be properly belted in while travelling.
- Never hold children or babies on your lap, this can result in potentially fatal injuries to the child!
- Never allow a child to be transported in a vehicle without being properly secured, or to stand up or kneel on a seat while travelling. In an accident, the child could be flung through the vehicle, causing possibly fatal injuries to themselves and to the other vehicle occupants.
- If children assume an improper sitting position when the vehicle is moving, they expose themselves to greater risk of injury in the event of a sudden braking manoeuvre or in an accident. This is particularly important if the

child is travelling on the front passenger seat and the airbag system is triggered in an accident; as this could cause serious injury or even death.

- A suitable child seat can protect your child!
- Never leave a child alone in the child seat or inside the vehicle because depending on the season, very high temperatures may be reached inside a parked vehicle, which could be fatal.
- Children who are less than 1.5 metres tall must not wear a normal seat belt without a child seat, as this could cause injuries to the abdominal and neck areas during a sudden braking manoeuvre or in an accident.
- Do not allow the seat belt to become twisted and the seat belt should be properly in place » page 68.
- Only one child may occupy a child seat » page 80, Child seats.
- When a child seat is mounted in the rear seats, the door child-proof lock should be activated » page 120.

Child seats

Safety instructions

Read the additional information carefully »  page 17.

⚠ WARNING

When travelling, children must be secured in the vehicle with a restraint system suitable for age, weight and size.

- Read and always observe information and warnings concerning the use of child seats
»» page 79.

⚠ WARNING

The retaining rings are designed only for use with "ISOFIX" and Top Tether* system child seats.

- Never secure other child seats that do not have the "ISOFIX" or Top Tether* system, or retaining belts or objects to the fastening rings - this can result in potentially fatal injuries to the child.
- Ensure that the child seat is secured correctly using the "ISOFIX" and Top Tether* securing rings.

⚠ WARNING

An undue installation of the safety seat will increase the risk of injury in the event of a crash.

- Never tie the retainer strap to a hook in the luggage compartment.
- Never secure or tie luggage or other items to the lower anchorages (ISOFIX) or the upper ones (Top Tether).

Categorisation of child seats into groups

Use only child seats that are officially approved and suitable for the child.

These seats are subject to the ECE-R 44 or ECE-R 129 standard. ECE-R stands for: Economic Commission for Europe Regulation.

The child seats are grouped into 5 categories:

Group 0: Up to 10 kg (up to around 9 months)

Group 0+: Up to 13 kg (up to around 18 months)

Group 1: from 9 to 18 kg (up to approx. 4 years old)

Group 2: from 15 to 25 kg (up to approx. 7 years old)

Group 3: From 22 to 36 kg (over around 7 years old)

Child seats that have been tested and approved under the ECE-R 44 or ECE-R 129 standard bear the test mark ECE-R 44 or ECE-R 129 on the seat (the letter E in a circle with the test number below it).

Follow the manufacturer's instructions and observe any statutory requirements when installing and using child seats.

We recommend you to always include the manufacturer's Child Seat Instruction Manual together with the on-board documentation.

SEAT recommends you use child seats from the **Original Accessories Catalogue**. These child seats have been designed and tested for use in SEAT vehicles. You can find the right child seat for your model and age group at SEAT dealers.

Child seats by approval category

Child seats may have the approval category of universal, semi-universal, vehicle specific (all according to the ECE-R 44 standard) or i-Size (according to the ECE-R 129 standard).

- **Universal:** Child seats with universal approval can be installed in all vehicles. There is no need to consult any list of models. In the case of universal approval for ISOFIX, the child seat is additionally provided with a Top Tether belt.
- **Semi-universal:** semi-universal approval, in addition to the standard requirements of universal approval, requires safety devices to lock the child seat, which require additional testing. Child seats with semi-universal approval include a list of vehicle models for which they can be installed.
- **Vehicle-specific:** vehicle-specific approval requires a dynamic test of the child seat for each vehicle model separately. Child seats with vehicle-specific approval also include a »

list of vehicle models for which they can be installed.


- **i-Size:** Child seats with i-Size approval must meet the requirements prescribed in the ECE-R 129 standard in relation to installation and safety. Child seat manufacturers can tell you which seats have i-Size approval for this vehicle.


Attachment systems

Depending on the country, different attachment systems are used for safely installing child seats.


Attachment systems overview


- **ISOFIX:** ISOFIX is a standardised attachment system allowing quick and safe attachment of child seats in the vehicle. ISOFIX attachment establishes a rigid connection between the child seat and the car body.

The child seat has two rigid attachment clips, called connectors. These connectors are fitted into the ISOFIX attachment rings found between the seat cushion and the backrest of the vehicle's back seat (on the sides). ISOFIX attachment systems are used mainly in Europe »  page 19. If necessary, ISOFIX attachment may have to be supplemented with a Top Tether belt or a support bracket.

- **Automatic three-point seat belt.** Whenever possible, it is preferable to attach the child seats with the ISOFIX system rather than attaching them with an automatic three-point seat belt »  page 18.

Additional attachment:

- **Top Tether:** The Top Tether belt is guided over the back of the rear seat and attached to an anchor point with a hook. Anchor points are located at the back of the rear seat backrest on the boot side »  page 22. The rings for retaining the Top Tether belt are marked with an anchor symbol.

- **Support bracket:** Some child seats rest on the floor of the vehicle with a support bracket. The support bracket prevents the child seat from tipping forward in the event of impact. Child seats fitted with a support bracket should only be used in the passenger seat and side rear seats » . For the assembly of this type of seat you should also consult the list of approved vehicles for this assembly, available in the instructions for child restraint systems.

Recommended systems for attaching child seats

SEAT recommends attaching child seats as follows:

- **Baby carriers or child seats in the opposite direction of travel:** ISOFIX and support bracket or iSize.
- **Child seats in the direction of travel:** ISOFIX and Top Tether.

WARNING

Incorrect use of the support bracket can cause serious or fatal injury.

- **Make sure the support bracket is correctly and safely installed.**

Emergencies

Self-help

Vehicle tool kit, anti-puncture kit*

The tools and anti-puncture kit* are stored under the floor panel in the luggage compartment.

To access the vehicle tools:

- Lift up the floor surface by the plastic handle until it is fastened to the tabs on both sides.

Depending on the vehicle equipment, the anti-puncture kit* is located under the floor panel in the luggage compartment.

The tool kit includes:

- Jack*
- Wire hook for pulling off the wheel cover*/wheel bolt cap clip.
- Box spanner for wheel bolts*
- Towline anchorage
- Adapter for the anti-theft wheel bolts*
- Towing bracket device

Some of the items listed are only provided in certain model versions, or are optional extras.

Note

The jack does not generally require any maintenance. If required, it should be greased using universal type grease.

Tyre repair

TMS (Tyre Mobility System)*

Read the additional information carefully

»  page 53

The Anti-puncture kit* (Tyre Mobility System) will reliably seal punctures caused by the penetration of a foreign body of up to about **4 mm** in diameter. **Do not remove foreign objects, e.g. screws or nails, from the tyre.**

After inserting the sealant residue in the tyre, you must again check the tyre pressure about 10 minutes after starting the engine.

You should only use the tyre mobility set if the vehicle is parked in a safe place, you are familiar with the procedure and you have the necessary tyre mobility set! Otherwise, you should seek professional assistance.

Do not use the tyre sealant in the following cases:

- If the wheel rim has been damaged.
- In outside temperatures below -20°C (-4°F).

- In the event of cuts or perforations in the tyre greater than 4 mm.
- If you have been driving with very low pressure or a completely flat tyre.
- If the sealant bottle has passed its use by date.

WARNING

Using the tyre mobility system can be dangerous, especially when filling the tyre at the roadside. Please observe the following rules to minimise the risk of injury:

- Stop the vehicle safely as soon as possible. Park it at a safe distance from surrounding traffic to fill the tyre.
- Ensure the ground on which you park is flat and solid.
- All passengers and particularly children must keep a safe distance from the work area.
- Turn on the hazard warning lights to warn other road users.
- Use the tyre mobility system only if you are familiar with the necessary procedures. Otherwise, you should seek professional assistance.
- The tyre mobility set is intended for temporary emergency use only until you can reach the nearest specialised workshop.
- Replace the repaired tyre with the tyre mobility set as soon as possible.

»

- The sealant is a health hazard and must be cleaned immediately if it comes into contact with the skin.
- Always keep the tyre mobility set out of the reach of small children.
- Never use an equivalent jack, even if it has been approved for your vehicle.
- Always stop the engine, apply the hand-brake lever firmly and engage gear if using a manual gearbox, in order to reduce the risk of vehicle involuntary movement.

⚠ WARNING

A tyre filled with sealant does not have the same performance properties as a conventional tyre.

- Never drive faster than 80 km/h (50 mph).
- Avoid heavy acceleration, hard braking and fast cornering.
- Drive for only 10 minutes at a maximum speed of 80 km/h (50 mph) and then check the tyre.

♻ For the sake of the environment

Dispose of used or expired sealant observing any legal requirements.

i Note

A new bottle of sealant can be purchased at SEAT dealerships.

i Note

Take into account the separate instruction manual of the tyre mobility set* manufacturer.

Contents of the tyre mobility system*

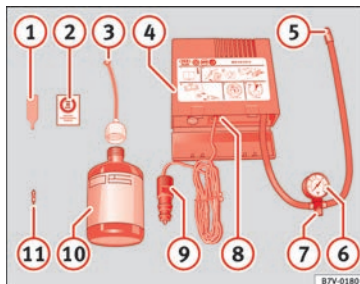


Fig. 95 Standard representation: contents of the anti-puncture kit.

The anti-puncture kit is located underneath the floor covering in the luggage compartment. It includes the following components

» **Fig. 95:**

- ① Tyre valve remover
- ② Sticker indicating maximum speed “max. 80 km/h” or “max. 50 mph”
- ③ Filler tube with cap

- ④ Air compressor
- ⑤ Tube for inflating tyres
- ⑥ Warning provided by tyre pressure monitoring system (it can also be integrated in the compressor).
- ⑦ Air bleed screw (in its place, the compressor may have a button).
- ⑧ ON/OFF switch
- ⑨ 12 volt connector
- ⑩ Bottle of sealant
- ⑪ Spare tyre valve

The **valve insert remover** ① has a gap at the lower end for a valve insert. The valve insert can only be screwed or unscrewed in this way. This also applies to its replacement part ⑪.

⚠ WARNING

When inflating the wheel, the air compressor and the inflator tube may become hot.

- Protect hands and skin from hot parts.
- Do not place the hot flexible inflator tube or hot air compressor on flammable material.
- Allow them to cool before storing the device.
- If it is not possible to inflate the tyre to at least 2.0 bars (29 psi / 200 kPa), the tyre is too badly damaged. The sealant is not in a good condition to seal the tyre. Do not continue driving. Seek specialist assistance.

ⓘ CAUTION

Switch off the air compressor after a maximum of 8 operational minutes to avoid overheating! Before switching on the air compressor again, let it cool for several minutes.

Check after 10 minutes of driving

Screw the inflator tube »» Fig. 95 ⑤ again and check the pressure on the gauge ⑥.

1.3 bar (19 psi / 130 kPa) and lower:

- **Stop the vehicle!** The tyre cannot be sealed sufficiently with the tyre mobility set.
- You should obtain professional assistance »» ⚠.

1.4 bar (20 psi / 140 kPa) and higher:

- Set the tyre pressure to the correct value again.
- Carefully resume your journey until you reach the nearest specialised workshop without exceeding 80 km/h (50 mph).
- Have the damaged tyre replaced.

⚠ WARNING

Driving with an unsealed tyre is dangerous and can cause accidents and serious injury.

- Do not continue driving if the tyre pressure is 1.3 bar (19 psi / 130 kPa) and lower.

- Seek specialist assistance.

Manual unlocking/locking**Introduction**

Read the additional information carefully

»» 📖 page 10, »» 📖 page 11.

The doors, rear lid and panoramic tilting sunroof can be locked manually and partially opened, for example if the key or the central locking is damaged.

⚠ WARNING

Opening and closing doors carelessly can cause serious injury.

- If the vehicle is locked from outside, the doors and windows cannot be opened from the inside.
- Never leave children or disabled people alone in the car. They could be trapped in the car in an emergency and will not be able to get themselves to safety.
- Depending on the time of the year, temperatures inside a locked and closed vehicle can be extremely high or extremely low resulting in serious injuries and illness or even death, particularly for young children.

⚠ WARNING

Getting in the way of the doors and the rear lid is dangerous and can lead to serious injury.

- Open and close the doors and the rear lid only when there is nobody in the way.

ⓘ CAUTION

When opening and closing in an emergency, carefully disassemble components and then reassemble them carefully to avoid damage to the vehicle.

Changing the windscreen wiper blades**Changing the windscreen and rear window wiper blades**

Read the additional information carefully

»» 📖 page 61.

The windscreen wiper blades are supplied as standard with a layer of graphite. This layer is responsible for ensuring that the wipe is silent. If the graphite layer is damaged, the noise of the water as it is wiped across the windscreen will be louder.

Check the condition of the wiper blades regularly. **If the wipers scrape across the glass, »»**

they should be changed if they are damaged, or cleaned if they are dirty » » ⓘ.

Damaged wiper blades should be replaced immediately. These are available from qualified workshops.

⚠ WARNING

Worn or dirty wiper blades reduce visibility and increase the risk of accident and serious injury.

- Always replace damaged or worn blades or blades which do not clean the windscreen correctly.

ⓘ CAUTION

• Damaged or dirty windscreen wipers could scratch the glass.

• If products containing solvents, rough sponges or sharp objects are used to clean the blades, the graphite layer will be damaged.

• Never use fuel, nail varnish remover, paint thinner or similar products to clean the windows.

• In icy conditions, always check that the wiper blades are not frozen to the glass before using the wipers. In cold weather, it may help to leave the vehicle parked with the wipers in service position » » 📖 page 60.

ⓘ CAUTION

- To prevent damage to the bonnet and the wiper arms, only leave them in the service position.
- Before driving, always lower the wiper arms.

Tow-starting and towing

Introduction

Tow-starting means starting the engine of the vehicle while another pulls it.

Towing means one vehicle pulling another that is not roadworthy.

Always consider the legal provisions relating to tow-starting and towing.

For technical reasons, towing a vehicle with a discharged battery is not allowed. The jump start should be used instead » » 📖 page 58.

If the vehicle comes with the Keyless Access system, towing is only allowed with the ignition on!

The vehicle battery drains if the vehicle is towed with the engine switched off and the ignition connected. Depending on the battery charge status, the drop in voltage may be so large, even after just a few minutes, that no electrical device in the vehicle may work e.g.

the hazard warning lights. In vehicles with the Keyless Access system, the steering wheel could lock » » ⚠.

⚠ WARNING

A vehicle with no power should never be towed.

• During towing, never switch off the ignition with the starter button. Otherwise, the electronic lock of the steering column could suddenly get blocked and it would be impossible to steer the vehicle. This could cause an accident, serious injury and loss of control of the vehicle.

• If during towing the vehicle runs out of power, stop towing immediately and request the assistance of specialist personnel.

⚠ WARNING

Vehicle handling and braking capacity change considerably during towing. Please observe the following instructions to minimize the risk of serious accidents and injury:


- As the driver of the vehicle being towed:
 - You should depress the brake much harder as the brake servo does not operate. Pay the utmost attention to avoid crashing into the towing vehicle.
 - More strength is required at the steering wheel as the power steering does not operate when the engine is switched off.
- As the driver of the towing vehicle:

- Accelerate with particular care and caution.
- Avoid sudden braking and manoeuvres.
- Brake earlier than usual and more smoothly.

ⓘ CAUTION

- To avoid damaging the vehicle, for example the paint, remove and replace the lid and towing eye carefully.
- Unburnt fuel could enter the catalytic converter and damage it during towing.

Indications for tow-starting

Vehicle's should not generally be tow-started. The jump start should be used instead »  page 58.

For technical reasons, towing the following vehicles is **not** allowed:

- Vehicles with an automatic gearbox.
- If the vehicle battery is discharged, because in vehicles with the Keyless Access locking and ignition system the steering remains locked and the electronic parking brake cannot be deactivated nor can the electronic lock of the steering column be released if they are activated.

- If the battery is flat, it is possible that the engine control units may not operate correctly.

However, if the vehicle must absolutely be tow-started (in the case of manual gearboxes):

- Engage the 2nd or 3rd gear.
- Keep the clutch pressed down.
- Switch on the ignition and the hazard warning lights.
- Once both vehicles are moving, release the clutch.
- Once the engine starts, press the clutch and disengage the gear to avoid colliding with the towing vehicle.

ⓘ CAUTION

When tow-starting, unburnt fuel could enter the catalytic converter and damage it.

ⓘ Note

The vehicle can only be tow-started if the electronic parking brake and, if appropriate, the electronic lock of the steering column are deactivated. If the vehicle has no power supply or there is an electric system fault, the engine must be tow-started to deactivate the electronic parking brake and the electronic lock of the steering column.

Indications for towing

Tow rope or tow bar

It is safer for the vehicle to be towed using a tow bar, avoiding damage to the vehicle. A tow rope should only be used if a tow bar is not available.

A tow rope should be slightly elastic to avoid damage to both vehicles. It is advisable to use a tow rope made of synthetic fibre or similarly elastic material.

Only attach the tow rope or the tow bar to the towing eyes provided or a towing bracket.

If the vehicle is **factory-equipped with a towing bracket**, it is **only** allowed to tow with a tow bar if this has been specially designed to be installed with a tow hitch » page 257.

When the vehicle needs to be towed:

Check whether the vehicle may be towed » page 88, **Cases where towing a vehicle is not allowed.**

- Switch the ignition on.
- Put the gearbox lever in neutral or the selector lever in the **N** position » page 176.
- Do not allow the vehicle to be towed at speeds of over 50 km/h (30 mph).
- Do not allow the vehicle to be towed at speeds of over 50 km.



- If a breakdown lorry is used, vehicles with automatic transmission are only allowed to be towed with the front wheels suspended.

Towing vehicles with four-wheel drive (4Drive)

Four-wheel drive vehicles (4Drive) can be towed using a tow bar or tow rope. If the vehicle is towed with the front or rear axle suspended, the engine must be switched off, otherwise the transmission may be damaged.


Cases where towing a vehicle is not allowed

- If, due to a fault, the gearbox is out of lubricant.
- If the vehicle battery is discharged, because the steering remains locked and, if appropriate, the electronic parking brake cannot be deactivated or the electronic lock of the steering column released.
- If a distance above 50 km needs to be travelled.
- When, for example, after an accident, the smooth rotation of the wheels or the steering operation cannot be guaranteed.

When the vehicle is to tow another vehicle:

- Observe legal requirements.
- Keep in mind the instructions in the manual on towing vehicles.

Note

The vehicle can only be towed if the electronic parking brake and the electronic lock of the steering column are deactivated. If the vehicle has no power supply or there is an electric system fault, the engine must be tow-started »  page 58 to deactivate the electronic parking brake and the electronic lock of the steering column.

Fitting the front towing eye



Fig. 96 Front bumper on right: remove the lid.



Fig. 97 Front bumper on right: towline anchorage screwed in.

The housing of the screw towing eye is on the right side of the front bumper behind a lid » **Fig. 96.**

The towing eye should always be kept in the vehicle.

Bear in mind the instructions for towing » **page 87.**

Fitting the towline anchorage

- Remove the towing eye from the vehicle tool kit in the luggage compartment » **page 83.**
- Extract the lid for the towing eye using a screwdriver or similar and pressing on the side.
- Remove the lid and let it hang from the vehicle.

- Screw the towing eye in the housing by turning it to the maximum **anticlockwise** » ❶. Use a suitable object that can completely and securely tighten the towing eye in its housing.
- After towing, unscrew the towing eye **clockwise** with a suitable object.
- Insert the side tab of the lid into the opening of the bumper and press until the tab is properly clipped into the bumper.
- Clean the towing eye if necessary and then store it in the luggage compartment along with the other vehicle tools.

❶ CAUTION

The towing eye must always be completely and firmly tightened. Otherwise, it could be released while towing and tow-starting.

Fitting the rear towing eye

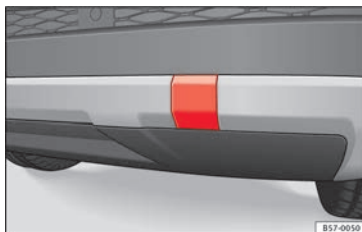


Fig. 98 Rear bumper on right: remove the lid.

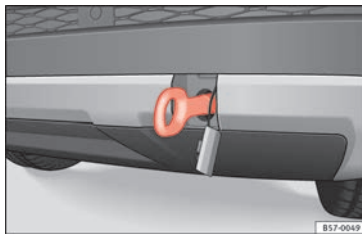


Fig. 99 Rear bumper on right: towline anchorage screwed in.

The housing of the screw towing eye is on the right side of the rear bumper behind a lid » Fig. 98. Vehicles equipped as standard with a towing bracket **do not** have any housing for the screw towing eye behind the lid. In this case, the tow hitch needs to be extracted

or installed and used for towing » page 255, » ❶.

Bear in mind the instructions for towing » page 87.

Assemble the rear towing eye (cars without a factory-equipped towing bracket)

- Remove the towing eye from the vehicle tool kit in the luggage compartment » page 83.
- Press the upper side of the lid » Fig. 98 to unclip it.
- Remove the lid and let it hang from the vehicle.
- Screw the towing eye in the housing by turning it to the maximum **anticlockwise** » Fig. 99 » ❶. Use a suitable object that can completely and securely tighten the towing eye in its housing.
- After towing, unscrew the towing eye **clockwise** with a suitable object.
- Insert the upper flange of the lid into the opening of the bumper and press the lower side of the lid until the upper flange is inserted into the bumper.
- Clean the towing eye if necessary and then store it in the luggage compartment along with the other vehicle tools.

ⓘ CAUTION

- The towing eye must always be completely and firmly tightened. Otherwise, it could be released while towing and tow-starting.
- If the vehicle is factory-equipped with a towing bracket, it is only allowed to tow with a tow bar if this has been specially designed to be installed with a tow hitch. If an unsuitable tow bar is used, both the tow hitch and the vehicle may be damaged. Instead, a tow rope should be used.

Driving tips for towing

Towing requires some expertise and experience, especially when using a tow rope. Both drivers should be familiar with the difficulties involved in towing. For this reason, inexperienced drivers should abstain from towing.

During towing, it should be ensured that no impermissible tractive forces or shocks are generated. When towing on an unpaved road, there is always a risk of overloading and damaging the anchorage points.

During towing, the towing vehicle can signal the change of direction even with the hazard warning lights turned on. To do so, at the same time, the turn signal lever must be operated with ignition switched on. Meanwhile, the hazard warning lights will go off. When the turn signal lever is returned to the rest

position, the hazard warning lights will be automatically reactivated.

Notes for the driver of the towed vehicle

- Leave the ignition on, so that the steering is not blocked, and the electronic parking brake may be deactivated and the turn signals and wash/wipe operated.
- More strength is required at the steering wheel as the power steering does not operate when the engine is switched off.
- You should depress the brake much harder as the brake servo does not operate. Avoid hitting the towing vehicle.
- Bear in mind the information and instructions in the manual of the vehicle to be towed.

Notes for the driver of the towing vehicle

- Accelerate with particular care and caution. Avoid sharp manoeuvres.
- Brake earlier than usual and smoothly.
- Bear in mind the information and instructions in the manual of the towed vehicle.

Fuses and bulbs**Fuses****Introduction**

In general, a fuse can be assigned to various electrical components. Likewise, an electrical component can be protected by several fuses.

Only replace fuses when the cause of the problem has been solved. If a newly inserted fuse blows after a short time, you must have the electrical system checked by a specialised workshop as soon as possible.

⚠ WARNING

The high voltages in the electrical system can give serious electrical shocks, causing burns and even death!

- **Never touch the electrical wiring of the ignition system.**
- **Take care not to cause short circuits in the electrical system.**

⚠ WARNING

Using unsuitable fuses, repairing fuses or bridging a current circuit without fuses can cause a fire and serious injury.

- Never use a fuse with a higher value. Only replace fuses with a fuse of the same amperage (same colour and markings) and size.
- Never repair a fuse.
- Never replace a fuse by a metal strip, staple or similar.

ⓘ CAUTION

- To prevent damage to the vehicle's electric system, before replacing a fuse always turn off the ignition, the lights and all electrical elements and remove the key from the ignition.
- If you replace a fuse with higher-rating fuse, you could cause damage to another part of the electrical system.
- Protect the fuse boxes when open to prevent the entry of dust or humidity as they can damage the electrical system.

ⓘ Note

- One component may have more than one fuse.
- Several components may run on a single fuse.

Vehicle fuses

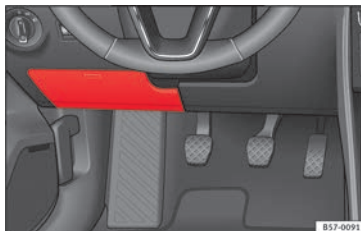


Fig. 100 On the driver-side dash panel: fuse box cover

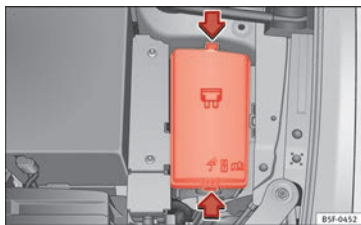


Fig. 101 In the engine compartment: fuse box cover

Read the additional information carefully
» page 51

Only replace fuses with a fuse of the same amperage (same colour and markings) and size.

Opening and closing the fuse box situated below the dash panel

- *Opening*: fold the cover down » **Fig. 100**.
- *Closing*: push back the cover in until it clicks into place.

To open the engine compartment fuse box

- Open the bonnet » page 282.
- Press the locking tabs to release the fuse box cover » **Fig. 101**.
- Then lift the cover out.
- To **fit** the cover, place it on the fuse box. Push the locking tabs down until they click audibly into place.

Fuses in the vehicle interior

No.	Consumers/Amps	
1	Adblue (SCR)	30
5	Gateway	5
6	Automatic gearbox lever	5
7	Air conditioning and heating control panel, back window heating, auxiliary heating.	10
8	Diagnosis, handbrake switch, light switch, reverse light, interior lighting, driving mode	10
9	Steering column	5
10	Radio display	7.5

Emergencies

No.	Consumers/Amps	
12	Radio	20
14	Air conditioner fan	40
15	Steering column release	10
16	Connectivity box koppelantenne	7.5
17	Instrument panel	5
18	Rear camera	7.5
19	Kessy	7.5
21	4x4 Haldex Control Unit	15
22	Trailer	15
23	Right lights	40
24	Electric sunroof	30
25	Left door	30
26	Heated seats	30
28	Trailer	25
31	Left lights	40
32	Parking aid control unit	7.5/10
33	Airbag	5
34	Reverse switch, clima sensor, electrochromic mirror	7.5
35	Diagnosis, headlight control unit, headlight adjuster	10

No.	Consumers/Amps	
36	Front camera, Radar	5/10
38	Trailer	25
39	Right door	30
40	12V socket	20
42	Central locking	40
43	Interior light	30
44	Trailer	15
45	Electric driver's seat	15
47	Rear window wiper	15
49	Starter motor; clutch sensor	5
50	Electric rear lid	40
53	Heated rear window	30

Fuse arrangement in engine compartment

No.	Consumers/Amps	
1	ESP control unit	40
2	ESP control unit	40
3	Engine control unit (diesel/petrol)	30/15
4	Engine sensors	5/10
5	Engine sensors	10
6	Brake light sensor	5

No.	Consumers/Amps	
7	Engine power supply	10
8	Lambda probe	10/15
9	Engine	5/20
10	Fuel pump control unit	15/20
11	PTC	40
12	PTC	40
13	Automatic gearbox control unit	15/30
14	Heated windscreen	40
15	Horn	15
17	Engine control unit	7.5
18	Terminal 30 (positive reference)	5
19	Front windscreen washer	30
20	Alarm horn	10
22	Engine control unit	5
23	Starter motor	30
24	PTC	40
31	Pressure pump	15
33	Gearbox pump	30
37	Parking heating	20

ⓘ CAUTION


- Always carefully remove the fuse box covers and refit them correctly to avoid problems with your vehicle.
- Protect the fuse boxes when open to avoid the entry of dust or humidity. Dirt and humidity inside fuse boxes can cause damage to the electrical system.

ⓘ Note


- In the vehicle, there are more fuses than those indicated in this chapter. These should only be changed by a specialised workshop.
- Positions not containing a fuse do not appear in the following tables.
- Some of the equipment listed in the tables below pertain only to certain versions of the model or are optional extras.
- Please note that the above lists, while correct at the time of printing, are subject to change.

Changing bulbs

Topic introduction

Read the additional information carefully
»  page 52.

Changing bulbs requires a certain degree of practical skill.

If you choose to change the engine compartment lamps yourself, remember that it is a dangerous area »  in **Work in the engine compartment on page 283.**

Always use identical bulbs with the same designation. The name can be found on the base of the bulb holder.

Depending on how equipped the vehicle is, there are different sets of headlights and tail lights:

- Halogen headlights
- Full-LED main headlights*
- Rear bulb light
- LED rear light*

Full-LED headlight system*

Full-LED headlights handle all light functions (daylight, side light, turn signal, dipped beam and route light) with light emitting diodes (LEDs) as a light source.

Full-LED headlights are designed to last the lifetime of the car and light bulbs cannot be replaced. In case of headlight failure, go to an authorised workshop to have it replaced.

 WARNING

- Take particular care when working on components in the engine compartment if the engine is warm. Risk of burns.

• Bulbs are highly sensitive to pressure. The glass can break when you touch the bulb, causing injury.

• When changing bulbs, please take care not to injure yourself on sharp edges, in particular on the headlight housing.

ⓘ CAUTION

- Remove the ignition key before working on the electric system. Otherwise, a short circuit could occur.
- Switch off the lights and the parking light before changing a bulb.
- Take good care to avoid damaging any components.

 For the sake of the environment

Please ask your specialist retailer how to dispose of used bulbs in the proper manner.

ⓘ Note

- Please check at regular intervals that all lighting (especially the exterior lighting) on your vehicle is functioning properly. This is not only in the interest of your own safety, but also that of all other road users.
- Before changing a bulb, make sure you have the correct new bulb.
- Do not touch the glass part of the bulb with your bare hands, use a cloth or paper towel instead, since the fingerprints left on the

glass will vaporise as a result of the heat generated by the bulb, they will be deposited on the reflector and will impair its surface.

Change the front bulbs

Dipped beam headlight

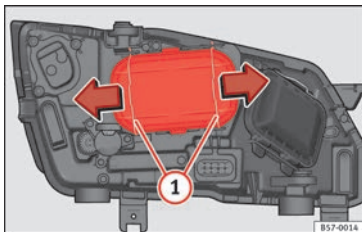


Fig. 102 In the engine compartment: remove the lid.

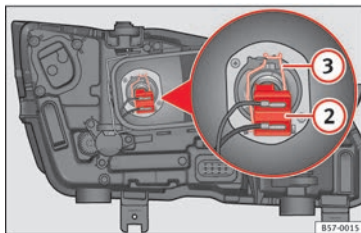


Fig. 103 In the engine compartment: dipped beam headlight.

Follow the steps indicated:

1. Raise the bonnet.
2. Move the loops » **Fig. 102** **1** in the direction of the arrow and remove the cover.
3. Remove connector » **Fig. 103** **2** from the bulb.
4. Unclip the retainer spring » **Fig. 103** **3** pressing clockwise and inwards.
5. Extract the bulb and fit the replacement so that the lug on the base fits into the recess on the reflector.
6. Installation involves all of the above steps in reverse sequence.

Main beam headlight bulb and turn signal bulb

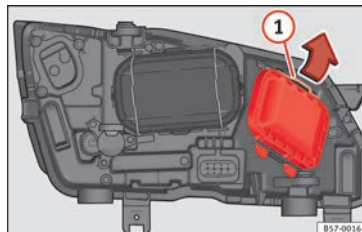


Fig. 104 In the engine compartment: remove the lid.

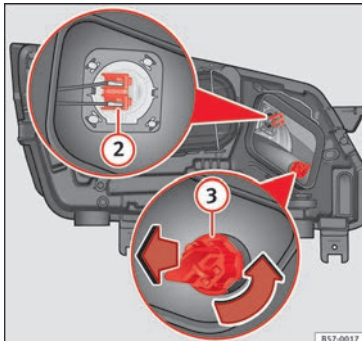


Fig. 105 In the engine compartment: main beam headlight bulb (2) and turn signal bulb (3).

Follow the steps indicated:

Main beam headlight bulb

1. Raise the bonnet.
2. Move the loop »» Fig. 104 (1) in the direction of the arrow and remove the cover.
3. Slide connector »» Fig. 105 (2) to the left or right and pull.
4. Remove the bulb by disconnecting the connector.
5. Installation involves all of the above steps in reverse sequence.

Turn signal bulb

1. Raise the bonnet.
2. Move the loop »» Fig. 104 (1) in the direction of the arrow and remove the cover.
3. Turn the bulb holder »» Fig. 105 (3) anticlockwise and pull.
4. Remove the bulb by pressing on the bulb holder and turning it anticlockwise at the same time.
5. Installation involves all of the above steps in reverse sequence.

Front fog light bulb*

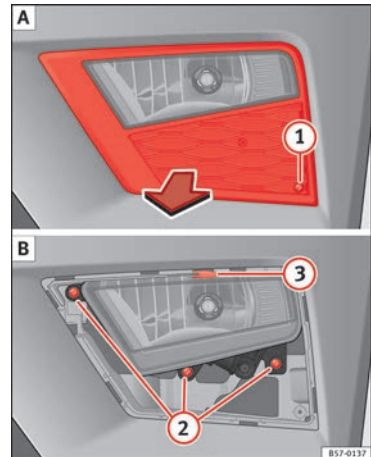


Fig. 106 Fog light: extracting the grille. »»

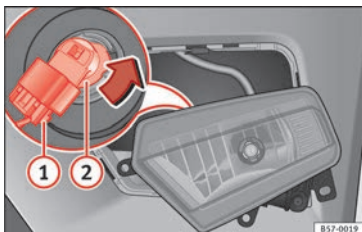


Fig. 107 Fog light: remove the bulb holder

Follow the steps indicated:

1. Remove the screw » **Fig. 106 ① A** from the fog light grille using a screwdriver and extract the grille.
2. Remove the screws (3x) » **Fig. 106 ② B** and extract the fog light.
3. Remove the metal clip situated on the upper part of the fog light by pulling towards the exterior of the vehicle **③**.
4. Remove connector » **Fig. 107 ①** from the bulb.
5. Turn the bulb holder » **Fig. 107 ②** anticlockwise and pull.
6. Remove the bulb by pressing on the bulb holder and turning it anticlockwise at the same time.
7. Installation involves all of the above steps in reverse sequence.
8. Check that the bulb works properly.

Note

Due to the difficulty of accessing fog light bulbs, have them replaced at a Technical Service or specialised workshop.

Change the rear bulbs

Overview of tail lights

Tail lights on side panel

Turn signal	PY21W NA LL
Side light and brake light	P21W LL

Tail lights on the rear lid

Left side	
Side lights	P21W LL
Fog light/side light	P21W LL
Reverse light	W16W
Right side	
Side lights	2 x P21W LL
Reverse light	W16W

The table corresponds to a right-hand traffic vehicle. The position of lights may vary according to the country.

Rear bulbs (in the side panel)

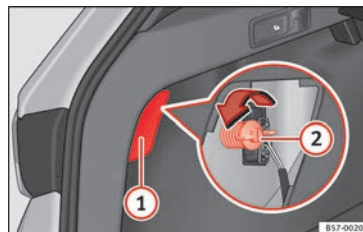


Fig. 108 Luggage compartment: access to the bolt securing the tail light unit.

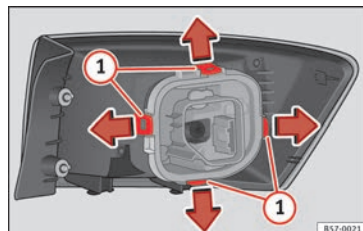


Fig. 109 Retaining tabs on reverse side of tail light.

Follow the steps indicated:

1. Check which of the bulbs is defective.
2. Open the rear lid.

- Remove the lid, levering it with the flat side of a screwdriver into the recess
»» Fig. 108 ①.
- Remove the bulb connector.
- Unscrew the light securing bolt by hand or using a screwdriver
»» Fig. 108 ②.
- Remove the light from the body, gently pulling it toward you, and place on a clean, smooth surface.
- Disassemble the bulb holder unlocking the securing tabs
»» Fig. 109 ①.
- Change the damaged bulb.
- To refit follow the steps in reverse order, taking special care when fitting the bulb holder. The securing tabs must click into place.

ⓘ CAUTION

Take care when removing the rear light unit to make sure there is no damage to the paint-work or any of its components.

ⓘ Note

- Make sure you have a soft cloth ready to place under the glass on the rear light unit, to avoid any scratches.
- In the case of LED lights, change only the turn signal bulb.

Rear lights (in the rear lid)



Fig. 110 Rear lid open: remove the lid.

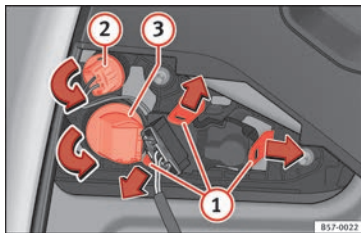


Fig. 111 Remove the bulb holder.

The rear lid must be open to change the bulbs.

Follow the steps indicated:

- Remove the rear lid cover in the direction indicated
»» Fig. 110.

- Unlock the securing tabs from the bulb holder
»» Fig. 111 ① or turn the bulb holder to the left ② and ③.
- Remove the bulb holder from its location.
- Lightly press the defective bulb into the bulb holder, then turn it to the left and remove it.
- Fit the new bulb, pressing it into the bulb holder and turn it to the right as far as it will go.
- Use a cloth to remove any fingerprints from the glass part of the bulb.
- Check that the new bulb works properly.
- Carry out the same actions in reverse order for assembly and pay special attention to placing the bulb holder, ensuring that the tabs are properly secured.

ⓘ Note

For LED pilots, you can only change the reverse bulb.

Changing number plate light bulbs



Fig. 112 In the rear bumper: number plate light.

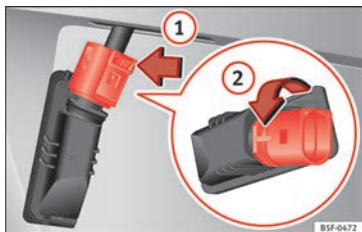


Fig. 113 Number plate light: Remove the bulb holder.

Follow the steps indicated:

1. Press the number plate light in the direction of the arrow » **Fig. 112**.
2. Remove the number plate bulb slightly.

3. In the connector lock, turn » **Fig. 113** towards the arrow ① and pull the connector.
4. Rotate the bulb holder in the direction of arrow ② and extract it with the bulb.
5. Replace the defective bulb with a new bulb with the same features.
6. Insert the bulb holder in the number plate light and turn in the opposite direction of arrow ② until it stops.
7. Plug the connector into the bulb holder.

Note

Depending on how equipped the vehicle is, the number plate lights may be LEDs. LEDs have an estimated life that exceeds that of the car. If a light with LEDs fails, go to an authorised workshop for replacement.

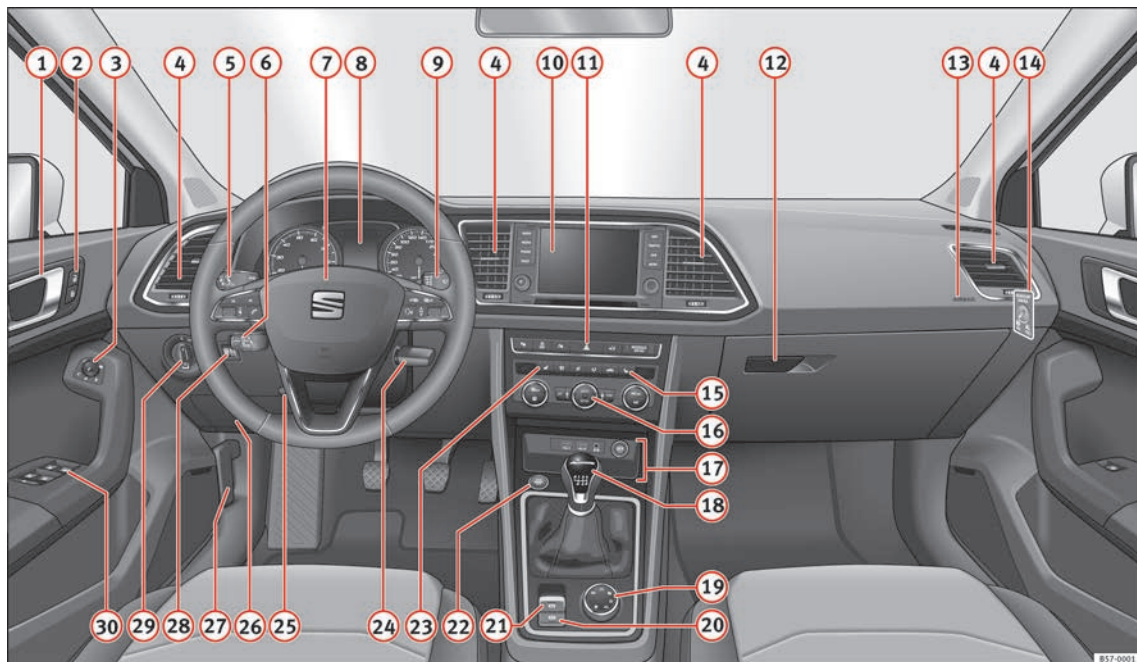


Fig. 114 Instruments and controls.

857-0001

Operation

Controls and displays

General instrument panel

- | | | | |
|---|-----|--|--------|
| ① Door release lever | | | |
| ② Central locking switch | 115 | | |
| ③ Control for the electric adjustment of the exterior mirrors | 141 | | |
| ④ Air outlets | 159 | | |
| ⑤ Control lever for: | | | |
| – Turn signals and main beam headlights | 131 | | |
| – Lane Assist | 213 | | |
| – Main beam assist | 132 | | |
| – Cruise control system (CCS) | 193 | | |
| ⑥ Depending on equipment fitted: | | | |
| – Lever for cruise control | 193 | | |
| ⑦ Steering wheel with horn and | | | |
| – Driver airbag | 15 | | |
| – On-board computer controls | 29 | | |
| – Controls for radio, telephone, navigation and speech dialogue system » Booklet Radio | | | |
| – Paddle levers for tiptronic gearshift (automatic gearbox) | 179 | | |
| ⑧ Instrument panel | 102 | | |
| | | ⑨ Control lever for: | |
| | | – Windscreen wipers and washer | 139 |
| | | – Wipe and wash system | 139 |
| | | – On-board computer | 29 |
| | | ⑩ Depending on equipment fitted: radio or display for Easy Connect (navigation, radio, TV/video) | 108 |
| | | ⑪ Depending on the equipment, buttons for: | |
| | | – Start-Stop system | 188 |
| | | – Park assist system | 244 |
| | | – Hazard warning lights | 135 |
| | | – Tyre pressure switch | 297 |
| | | – Airbag off display | 78 |
| | | ⑫ Depending on the equipment, glove compartment with: | 148 |
| | | – CD player* and/or SD card* | |
| | | » Booklet Radio | |
| | | ⑬ Front passenger airbag | 15 |
| | | ⑭ Front passenger airbag switch | 78 |
| | | ⑮ Passenger seat heating control | 144 |
| | | ⑯ Depending on the equipment, controls for: | |
| | | – Heating and ventilation system or manual air conditioner | 46, 44 |
| | | – Automatic air conditioner | 42 |
| | | ⑰ Depending on the equipment: | |
| | | – USB/AUX-IN input | 111 |
| | | – Lighter/power socket | 148 |
| | | – Wireless charger | 111 |
| | | – Storage compartment | |
| | | ⑱ Gear lever for: | |
| | | – Manual gearbox | 176 |
| | | – Automatic gearbox | 177 |
| | | ⑲ Rotating control (Driving Experience button) for driving modes | 225 |
| | | ⑳ Auto Hold switch | 191 |
| | | ㉑ Electronic parking brake switch | 170 |
| | | ㉒ Starter button (Keyless Access locking and ignition system) | 167 |
| | | ㉓ Driver's seat heating control | 144 |
| | | ㉔ Ignition lock (vehicles without Keyless Access) | 165 |
| | | ㉕ Steering column adjustment lever | 14 |
| | | ㉖ Knee airbag | 16 |
| | | ㉗ Bonnet lock release | 283 |
| | | ㉘ Headlight range control | 137 |
| | | ㉙ Headlight switch | 131 |
| | | ㉚ Electric windows | 126 |

Note

- Some of the equipment listed in this section is only fitted on certain models or are optional extras.
- A separate Instructions Manual is enclosed if the vehicle is equipped with a factory-fitted **»**

radio, CD player, AUX IN connection or navigation system.

- The arrangement of switches and controls on right-hand drive models* may be slightly

different from the layout shown in » page 100. However, the symbols used to identify the controls are the same.

Instruments and warning/control lamps

Instruments

View of instrument panel

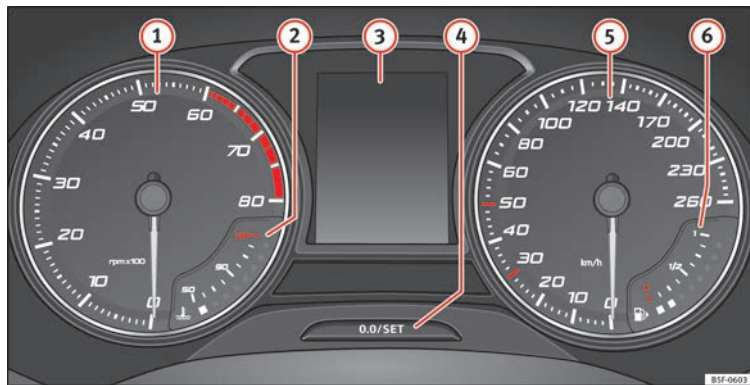


Fig. 115 Instrument panel, on dash panel

Details of the instruments » Fig. 115:

- 1 **Rev counter** (with the engine running, in hundreds of revolutions per minute).

The beginning of the red zone of the rev counter indicates the maximum speed in any gear after running-in and with the

engine hot. However, it is advisable to change up a gear or move the selector lever to **D** (or lift your foot off the accelerator) before the needle reaches the red zone » ❶.

- ❷ **Engine coolant temperature display** » page 105.
- ❸ **Displays on the screen** » page 103.
- ❹ **Adjuster button and display** » page 105.
- ❺ **Speedometer.**
- ❻ **Fuel gauge** » page 106.

WARNING

Any distraction may lead to an accident, with the risk of injury.

- Do not operate the instrument panel controls when driving.

❶ CAUTION

- To prevent damage to the engine, the rev counter needle should only remain in the red zone for a short period of time.
- When the engine is cold, avoid high revs and heavy acceleration and do not make the engine work hard.

For the sake of the environment


Changing up a gear in time reduces fuel consumption and noise.

Rev counter

The rev counter indicates the number of engine revolutions per minute » Fig. 115 ❶.

Together with the gear-change indicator, the rev counter offers you the possibility of using the engine of your vehicle at a suitable speed.

The start of the red zone on the dial indicates the maximum engine speed which may be used briefly when the engine is warm and after it has been run in properly. Before reaching this range, you should change to a higher gear for vehicles with a manual gearbox or for automatic gearboxes put the selector lever in “D” or take your foot off the accelerator pedal.

We recommend that you avoid high revs and that you follow the recommendations on the gear-change indicator. Consult the additional information in »  page 31, Gear-change indicator.

❶ CAUTION









Never allow the rev counter needle ❶ » Fig. 115 to go into the red zone on the scale for more than a very brief period, otherwise there is a risk of engine damage.

For the sake of the environment

Changing up a gear early will help you to save fuel and minimise emissions and engine noise.

Indications on the display

A variety of information can be viewed on the instrument panel display » Fig. 115 ❸, depending on the vehicle equipment:

- Bonnet, rear lid and doors open »  page 32.
- Warning and information messages »  page 32.
- Distance travelled » page 105.
- Time » page 104.
- Navigation instructions.
- Outside temperature »  page 31.
- Compass » page 104.
- Shift lever position » page 177.
- Recommended gear (manual gearbox) »  page 31.
- Multifunction display (MFD) and menus with different setting options »  page 29.
- Service interval display »  page 35.
- Second speed display »  page 29.
- Speed warning function »  page 35. »

- Start-Stop system status display
»» page 188.
- Active cylinder management display (ACT®)* »» page 185
- Signs recognised by the traffic signal detection system »» page 228
- Low consumption driving status (ECO)
»» page 104
- Identifying letters on engine (MKB).

Distance travelled

The *odometer* registers the total distance travelled by the car.

The *odometer* (**trip**) shows the distance travelled since the last odometer reset. The last digit of the trip recorder indicates distances of 100 metres or one tenths of a mile.

- Briefly press the button »» Fig. 115 (4) to reset the trip recorder to 0.
- Keep the button (4) pressed for about 3 seconds and the previous value will be displayed.

Time

- To set the time, keep the button »» Fig. 115 (4) pressed for more than 3 seconds to select the hour or minute display.
- To continue setting the time, press the upper or lower part of the button (4). Hold but-

ton down to scroll through the numbers quickly.

- Press the button (4) again in order to finish setting the time.

The time can also be set via the (CAR) key and (Setup) function button in the Easy Connect system »» page 108.


Compass

With the ignition on and the navigation system on, the cardinal point corresponding to the direction of travel of the vehicle is displayed on the instrument panel.

Selector lever position

The selected gear is displayed on the side of the selector lever and on the instrument panel display. In positions **D** and **S**, and with the Tiptronic, the corresponding gear is also displayed.

Recommended gear (manual gearbox)

The recommended gear in order to save fuel is displayed on the instrument panel while you are driving »»  page 31.


Second speed display (mph or km/h)

In addition to the speedometer, the speed can also be displayed in a different unit of measurement (in miles or in km per hour).

This option cannot be deactivated in models destined for countries in which the second speed must always be visible.

The second speed display can be adjusted in the Easy Connect system via the (CAR) key and the (Setup) function button »» page 108.

Speed warning

When the speed setting is exceeded, this will be indicated on the instrument panel display. This is very useful, for example when using winter tyres that are not designed for driving at the maximum speed of the vehicle
»»  page 35.

The speed warning settings can be adjusted in the Easy Connect system via the (CAR) key and the (Setup) function button »» page 108.

Start-Stop operating display

Updated information relating to the status is displayed on the instrument panel
»» page 188.

Low consumption driving status (ECO)*

Depending on the equipment, when driving, the “ECO” display appears on the instrument panel when the vehicle is in low consumption status due to active cylinder management (ACT®)* »» page 185.

Identifying letters on engine (MKB)

Hold the button **» Fig. 115 ④** down for more than 15 seconds to display the identifying letters of the vehicle engine (MKB). To do this, the ignition must be switched on and the engine switched off.

⚠ WARNING

Observe the safety warnings **»** ⚠ in Warning and control lamps on page 107.

⚠ WARNING

Even though outside temperatures are above freezing, some roads and bridges may be icy.

- At outside temperatures above +4°C (+39°F), even when the “ice crystal” symbol is not visible, there may still be patches of ice on the road.
- Do not rely on the outside temperature indicator!

i Note

- Different versions of the instrument panel are available and therefore the versions and instructions on the display may vary. In the case of displays without warning or information texts, faults are indicated exclusively by the warning lamps.
- Depending on the equipment, some settings and instructions can also be carried out in the Easy Connect system.

- When several warnings are active at the same time, the symbols are shown successively for a few seconds and will stay on until the fault is rectified.

Odometer

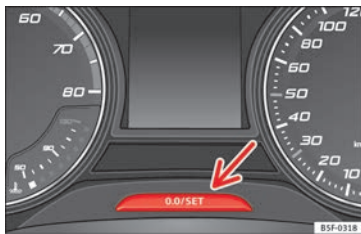


Fig. 116 Instrument panel: odometer and reset button.

The distance covered is displayed in “kilometres” or miles “m”. It is possible to change the measurement units (kilometres “km”/miles “m”) in the radio/Easy Connect*. Please refer to the Easy Connect* Instructions Manual for more details.

Odometer/trip recorder

The odometer shows the total distance covered by the vehicle.

The trip recorder shows the distance that has been travelled since it was last reset. It is

used to measure short trips. The last digit of the trip recorder indicates distances of 100 metres or tenths of a mile.

The trip recorder can be set to zero by pressing **0.0/SET** **» Fig. 116**.

Fault display

If there is a fault in the instrument panel, the letters DEF will appear in the trip recorder display. Have the fault repaired immediately, as far as is possible.

Coolant temperature gauge


For vehicles with no coolant temperature gauge, a control lamp **⚡** appears for high coolant temperatures **» page 286**. Please note **»** **!**.

The coolant temperature gauge **②** **» Fig. 115** only works when the ignition is switched on. In order to avoid engine damage, please read the following notes for the different temperature ranges.



Engine cold

If only the diodes in the lower part of the scale light up, this indicates that the engine has not yet reached operating temperature. Avoid high revs and heavy acceleration and do not make the engine work hard.


Normal temperature

If in normal operations, the diodes light up until the central zone, it means that the engine has reached operating temperature. At high outside temperatures and when making the engine work hard, the diodes may continue lighting up and reach the upper zone. This is no cause for concern, provided the control lamp  does not light up on the instrument panel digital display.

Heat range

When the diodes light up in the upper area of the display and the control lamp appears  on the instrument panel display, the coolant temperature is excessive  page 286.

ⓘ CAUTION

• To ensure a long useful life for the engine, avoid high revs, driving at high speed and making the engine work hard for approximately the first 15 minutes when the engine is cold. The phase until the engine is warm also depends on the outside temperature. If necessary, use the engine oil temperature*  page 34 as a guide.

• Additional lights and other accessories in front of the air inlet reduce the cooling effect of the coolant. At high outside temperatures and high engine loads, there is a risk of the engine overheating.





• The front spoiler also ensures proper distribution of the cooling air when the vehicle is



moving. If the spoiler is damaged this can reduce the cooling effect, which could cause the engine to overheat. Seek specialist assistance.



Fuel level



Fig. 117 Fuel gauge.

The display   Fig. 115 only works when the ignition is switched on. When the display reaches the reserve mark, the lower diode lights up in red and the control lamp  appears  page 102. When the fuel level is very low, the lower diode flashes in red.

The distance to empty fuel level is displayed on the instrument panel   Fig. 115.



The capacity of the fuel tank of your vehicle is given in the Technical data section   page 48.





ⓘ CAUTION


Never run the fuel tank completely dry. An irregular fuel supply could cause misfiring. In this way the unburned fuel can reach the exhaust system, which could cause the catalytic converter to overheat resulting in damage.

Control lamps

Warning and control lamps

Read the additional information carefully   page 38.

The control and warning lamps are indicators of warnings,  , faults   or certain functions. Some control and warning lamps come on when the ignition is switched on, and switch off when the engine starts running, or while driving.

Depending on the model, additional text messages may be viewed on the instrument panel display. These may be purely informative or they may be advising of the need for action  page 102, Instruments.

Depending upon the equipment fitted in the vehicle, instead of a warning lamp, sometimes a symbol may be displayed on the instrument panel.

When certain control and warning lamps are lit, an audible warning is also heard.

⚠ WARNING

If the warning lamps and messages are ignored, the vehicle may stall in traffic, or may cause accidents and severe injuries.

- Never ignore the warning lamps or text messages.
- Stop the vehicle safely as soon as possible.
- Park the vehicle away from traffic and ensure that there are no highly flammable materials under the vehicle that could come into contact with the exhaust system (e.g. dry grass, fuel).
- A faulty vehicle represents a risk of accident for the driver and for other road users. If necessary, switch on the hazard warning lamps and put out the warning triangle to advise other drivers.
- Before opening the bonnet, switch off the engine and allow it to cool.
- In any vehicle, the engine compartment is a hazardous area and could cause severe injuries »» page 282.

ⓘ CAUTION

Failure to heed the control lamps and text messages when they appear may result in faults in the vehicle.

Introduction to the Easy Connect system*

System settings (CAR)*

CAR menu (Setup)

Read the additional information carefully

»  page 26

To select the settings menus, press the Easy Connect (CAR) button and the (Setup) function button.

The actual number of menus available and the name of the various options in these menus will depend on the vehicle's electronics and equipment.

Pressing the menu button will always take you to the last menu used.

When the function button check box is activated , the function is active.

Pressing the menu button (⏪) will always take you to the last menu used.

Any changes made using the settings menus are automatically saved on closing those menus.

Function buttons in the vehicle settings menu	Page
ESC system	»» page 173
Tyres	»» page 295
Driver assistance	»» table on page 26
Parking and manoeuvring	»» page 244
Vehicle lights	»» table on page 26
Mirrors and windscreen wipers	»» table on page 26
Opening and closing	»» table on page 26
Multifunction display	»» table on page 26
Date and time	»» table on page 26
Units	»» table on page 26
Service	»» page 103
Factory settings	»» table on page 26

WARNING

Any distraction may lead to an accident, with the risk of injury. Operating the Easy Connect system while driving could distract you from traffic.

Communications and multimedia

Steering wheel controls*

Operating the audio system + telephone with voice control

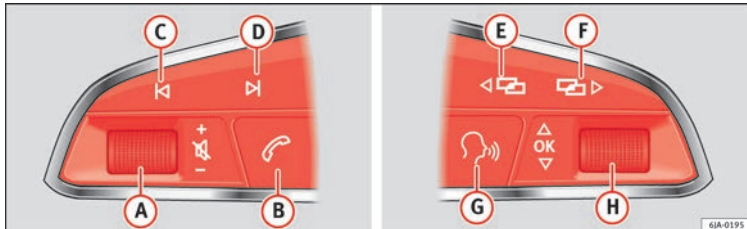


Fig. 118 Controls on the steering wheel.

The steering wheel includes a multifunction module from where it is possible to control the audio, telephone and radio/navigation

functions without needing to distract the driver.

- for controlling the audio functions available (radio, audio CD, MP3, iPod^{®1)}, USB¹⁾, SD¹⁾) and Bluetooth system from the steering wheel.

¹⁾ Depending on the vehicle equipment.

Operation

Button	Radio	Media (except AUX)	AUX	Telephone ^{a)}	Navigation ^{a)}
A	<i>Turn:</i> Turn volume up/down <i>Press:</i> Mute	<i>Turn:</i> Turn volume up/down <i>Press:</i> Mute	<i>Turn:</i> Turn volume up/down <i>Press:</i> Mute	<i>Turn:</i> Turn volume up/down <i>Press:</i> Mute	<i>Turn:</i> Turn volume up/down <i>Press:</i> Mute
B	<i>Short press:</i> access to the telephone menu on the dash panel ^{a)} . <i>Hold down:</i> redial ^{a)}	<i>Short press:</i> access to the telephone menu on the dash panel ^{a)} . <i>Hold down:</i> redial ^{a)}	<i>Short press:</i> access to the telephone menu on the dash panel ^{a)} . <i>Hold down:</i> redial ^{a)}	<i>Short press:</i> answer/hang up calls, enable/open the telephone menu. <i>Hold down:</i> reject an incoming call/switch to private/redial mode	<i>Short press:</i> access to the telephone menu on the dash panel ^{a)} . <i>Hold down:</i> redial ^{a)}
C	Search for last station	<i>Short press:</i> switch to the previous song <i>Hold down:</i> quick rewind	No function	No function ^{b)}	Radio/media functionality (except AUX)
D	Search for the next station	<i>Short press:</i> switch to the next song <i>Hold down:</i> fast forward	No function	No function ^{b)}	Radio/media functionality (except AUX)
E, F	Change menu on instrument panel ^{a)}	Change menu on instrument panel ^{a)}	Change menu on instrument panel ^{a)}	Change menu on instrument panel ^{a)}	Change menu on instrument panel ^{a)}
G	Enable/disable voice control ^{a)}	Enable/disable voice control ^{a)}	Enable/disable voice control ^{a)}	No function ^{b)}	Enable/disable voice control
H	<i>Turn:</i> Next/previous preset ^{c)} <i>Press:</i> Acts on the MFD or confirms the menu option of the dash panel depending on the menu option	<i>Turn:</i> Next/previous song ^{c)} <i>Press:</i> Acts on the MFD or confirms the menu option of the dash panel depending on the menu option	<i>Turn:</i> Acts upon the dash panel menu depending on where it is located <i>Press:</i> Acts on the MFD or confirms the menu option of the dash panel depending on the menu option	<i>Turn:</i> Acts upon the dash panel menu depending on where it is located <i>Press:</i> Acts on the MFD or confirms the menu option of the dash panel depending on the menu option	<i>Turn:</i> Acts upon the dash panel menu depending on where it is located <i>Press:</i> Acts on the MFD or confirms the menu option of the dash panel depending on the menu option

^{a)} According to the vehicle's equipment package.

^{b)} When a call is being made, radio/media functionality (except AUX).

^{c)} Only if the dash panel is in audio menu.

Multimedia

USB/AUX-INPort



Fig. 119 Centre console: USB/AUX-IN input.

Depending on the special characteristics and the country, the vehicle may have a USB/AUX-IN port.

The USB/AUX-IN port can be found in the storage compartment area of the centre console » **Fig. 119**.

The operating description is located in the respective Instruction Manuals of the audio system or the navigation system.

Connectivity Box*



Fig. 120 Centre console: Connectivity Box

Depending on the special features and the country, the vehicle may have a Connectivity Box.

With the Connectivity Box you can charge your mobile device wirelessly with Qi¹⁾ technology as well as reduce the radiation in the vehicle and have better reception.

The Connectivity Box can be found in the storage compartment area of the centre console » **Fig. 120**.

The operating description is located in the respective Instruction Manuals of the audio system or the navigation system.

Note

Your mobile device must support the Qi wireless inductive charging interface standard for proper operation.

¹⁾ Qi technology allows you to charge your mobile phone wirelessly.

Opening and closing


Central locking system

Description

Read the additional information carefully

»  page 9

The vehicle can be locked and unlocked via the central locking system. There are several methods, depending on the vehicle equipment:

- key with remote control » page 114,
- lock on driver door (emergency opening »  page 9) or
- interior central locking switch » page 115.

Unlocking one side of the vehicle only

When you lock the vehicle with the key, the doors and the rear lid are locked. When you open the door, you can either unlock *only* the driver door, or all the vehicle doors. To select the required option, use Easy Connect* » page 115.

Automatic locking (Auto Lock)*

The Auto Lock function locks the doors and the rear lid when the vehicle exceeds a speed of about 15 km/h (9 mph).

The vehicle is unlocked again when the ignition key is removed. Alternatively, the vehicle can also be unlocked via the central locking switch or by pulling one of the inside door handles. The Auto Lock function can be switched on and off on the sound system or on the Easy Connect* system » page 115.


In the event of an accident in which the airbags inflate, the doors will be automatically unlocked to facilitate access and assistance.

Anti-theft alarm system*

If the anti-theft alarm system senses interference with the vehicle it triggers an audible and visible alarm.

The anti-theft alarm system is automatically switched on when locking the vehicle. It switches off when the vehicle is unlocked from a distance.

When the driver door is unlocked with the key, you should switch on the ignition within 15 seconds. Otherwise the alarm will be triggered. On some export versions, the alarm is triggered immediately when you open a door.

To deactivate the alarm, press the button  on the remote control key, or switch on the ignition. After a certain time, the alarm will automatically switch off.

Switch off the vehicle interior monitoring and tow-away protection if you wish to prevent

the alarm from being triggered accidentally » page 123.

Turn signals

The turn signals will flash twice when the vehicle is unlocked and once when the vehicle is locked.

If it does not flash, this indicates that one of the doors, the rear lid or the bonnet is not closed correctly.

Accidental lock-out

The central locking system prevents you from being locked out of the vehicle in the following situations:

- If the driver door is open, the vehicle cannot be locked with the central locking switch » page 115.

Lock the vehicle with the remote control key, when all the doors and the rear lid have been closed. This prevents the accidental locking of the vehicle.

WARNING

Do not leave anyone (especially children) in the vehicle if it is locked from the outside and the anti-theft security system* is enabled, as the doors and windows cannot then be opened from the inside. Locked doors could delay assistance in an emergency, potentially putting lives at risk.

 Note

- Never leave any valuable items in the vehicle unattended. Even a locked vehicle is not a safe.
- If the diode on the driver door sill lights up for about 30 seconds when the vehicle is locked, the central locking system or anti-theft alarm* is not working properly. You should have the fault repaired at a SEAT Official Service or specialised workshop.
- The vehicle interior monitoring of the anti-theft alarm* system will only function as intended if the windows and the sunroof* are closed.

Car key

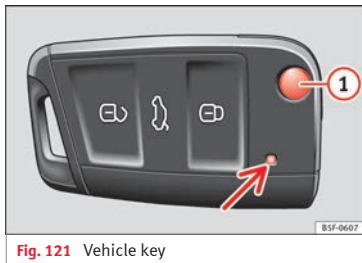


Fig. 121 Vehicle key



Fig. 122 Vehicle key with alarm button

Vehicle key

With the vehicle key the vehicle may be locked or unlocked remotely » page 112.

The vehicle key includes an emitter and battery. The receiver is in the interior of the vehicle. The range of the vehicle key with remote control and new battery is several metres around the vehicle.

If it is not possible to open or close the vehicle using the remote control key, this should be re-synchronised » page 120 or the battery changed » page 120.

Different keys belonging to the vehicle may be used.

Control lamp on the vehicle key

When a button on the vehicle key is pressed, the control lamp flashes » Fig. 121 (arrow) once briefly, but if the button is held down for

a longer period the control lamp flashes several times, such as in convenience opening.

If the vehicle key control lamp does not light up when the button is pressed, replace the key's battery » page 120.

Unfolding and folding the key shaft

Press button ① » Fig. 121 or » Fig. 122 to unlock and unfold the key shaft.

To fold the shaft away, press button ① and fold the key shaft in until it locks in place.

Alarm button*

Only press alarm button ② in the event of an emergency! When the alarm button is pressed, the vehicle horn is heard and the turn signals are switched on for a short time. When the alarm button is pressed again, the alarm is switched off.

Spare key

To obtain a spare key and other vehicle keys, the vehicle chassis number is required.

Each new key contains a microchip which must be coded with the data from the vehicle electronic immobiliser. A vehicle key will not work if it does not contain a microchip or the microchip has not been encoded. This is also true for keys which are specially cut for the vehicle. »

The vehicle keys or new spare keys can be obtained from a SEAT Official Service, a specialised workshop or an approved key service qualified to create this kind of key.

New keys or spare keys must be synchronised before use » page 120.

ⓘ CAUTION

All of the vehicle keys contain electronic components. Protect them from damage, impacts and humidity.

ⓘ Note

- Only use the key button when you require the corresponding function. Pushing the button unnecessarily could accidentally unlock the vehicle or trigger the alarm. It is also possible even when you are outside the radius of action.

- Key operation can be greatly influenced by overlapping radio signals close to the vehicle working in the same range of frequencies, for example, radio transmitters or mobile telephones.

- Obstacles between the remote control and the vehicle, bad weather conditions and discharged batteries can considerably reduce the range of the remote control.


- If the buttons of the vehicle key are pressed » Fig. 121 or » Fig. 122 or one of the central locking buttons » page 115 is pressed repeatedly in short succession, the central locking briefly disconnects as protection


against overloading. The vehicle is then unlocked. Lock it if necessary.

Unlocking/Locking by remote control


Read the additional information carefully

»  page 9

The vehicle will be locked again automatically if you do not open one of the doors or the rear lid within 30 seconds after unlocking the car. This function prevents the vehicle from remaining unlocked if the unlocking button is pressed by mistake. This does not apply if you press the button  for at least one second.

In vehicles with a **security central locking feature** (selective unlocking of side doors) » page 114, when the button  is pressed once, only the driver door and the fuel tank flap are unlocked. When the button is pressed a second time, all the vehicle doors are unlocked.

⚠ WARNING

Observe the safety warnings »  in Description on page 112.

ⓘ Note


- Do not use the remote control key until the vehicle is visible.

- Other functions of the remote control key » page 127, Convenience opening/closing.


Selective unlocking system

The selective unlocking system allows you to only unlock the driver door and the fuel tank flap. All other doors and the rear lid remain locked.

Unlocking the driver door and tank flap

– Press button  on the remote control key *once*, or turn the key *once* to open.

Unlocking all the doors, the rear lid and the tank flap simultaneously.

– Within 5 seconds, press button  on the remote control key *twice*, or turn the key to open *twice* within 5 seconds.

The anti-theft security system* and the anti-theft alarm* are immediately disabled if you unlock only the driver door, without unlocking the other doors.

In vehicles with Easy Connect*, you can programme the security central locking system directly » page 115.

Programming the central locking system

You can use Easy Connect* to select which doors are unlocked with the central locking system. Using the radio or the Easy Connect* system, you can select whether the vehicle automatically closes with the “Auto Lock” programme at speeds of more than 15 km/h (9 mph).

Programming the unlocking of the doors (vehicles with Easy Connect)

– Select: control button **Systems** or **Vehicle systems** › **Vehicle settings** › **Central locking** › **Unlocking doors**.


Programming the Auto Lock (vehicles with radio)

– Select: **SETUP** button › control button **Central Locking** › **Locking while driving**.


Programming the Auto Lock (vehicles with Easy Connect)

– Select: control button **Systems** or **Vehicle systems** › **Vehicle settings** › **Locking while driving**.

Unlocking doors You can choose to unlock **all** the doors or only the **driver door** when you unlock the vehicle. In **all** the options, the fuel tank flap is also unlocked.


With the **Driver** setting, when you press the  button on the remote control key only the door on the driver's side is unlocked. If that button is pressed twice, the rest of the doors and the rear lid will be unlocked.

In vehicles with a conventional key, turn the key in the door lock, in the direction of opening, twice within 2 seconds.

If the button  is pressed, all the vehicle doors are locked. At the same time, a confirmation signal* is heard.

Auto Lock/Locking while driving. If you select **on**, all the vehicle doors are locked at speeds above 15 km/h (9 mph).

Central locking switch


Read the additional information carefully  page 9

Please note the following when using the central locking switch to lock your vehicle:



- It is not possible to open the doors or the rear lid from the *outside* (for safety reasons, e.g. when stopped at traffic lights).
- The LED in the central locking switch lights up when all the doors are closed and locked.
- You can open the doors individually from the inside by pulling the inside door handle.

- In the event of an accident in which the airbags inflate, doors locked from the inside will be automatically unlocked to facilitate access and assistance.

WARNING

- **The central locking switch also operates when the ignition is switched off and automatically locks all the vehicle doors when the button  is pressed.**
- **The central locking switch does not operate if the vehicle is locked from the outside and the anti-theft security system is switched on.**
- **Locked doors could delay assistance in an emergency, potentially putting lives at risk. Do not leave anyone, especially children, in the vehicle.**

Note

Your vehicle will lock automatically when it reaches a speed of about 15 km/h (9 mph) (Auto Lock)  page 112. You can unlock the vehicle again using button  on the central locking switch.

Unlocking and locking the vehicle with Keyless Access*

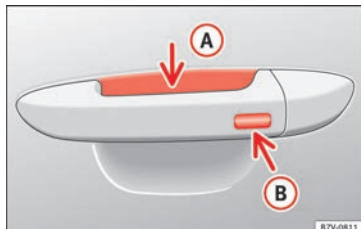
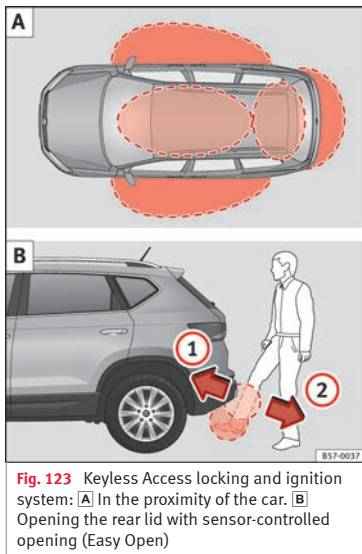


Fig. 124 Keyless Access locking and ignition system: sensor surface **A** for unlocking inside the door handle and sensor surface **B** for locking on the exterior of the handle.

»» table on page 2

Depending on the equipment, the vehicle may have the Keyless Access system.

Keyless Access is a key-free locking and ignition system to unlock and lock the vehicle without actively using its key. To do this, it is only necessary to have a valid vehicle key in the corresponding detection area to attempt to access the vehicle »» **Fig. 123 A** and touch one of the sensor surfaces on the door handles »» **Fig. 124** or operate the soft-touch/handle on the rear lid »» page 123 »» ①.

The vehicle can be unlocked and locked via the front doors only. When doing so, the remote control key must be no further than approx. 1.5 m from the door handle.

It does not matter where you carry the key, for instance whether it is in your jacket pocket or in a briefcase.

Once the doors have been locked, they cannot be opened again immediately. This will enable you to check that the doors are properly closed.

If you wish, when unlocking, you can unlock *only* the corresponding door or the entire vehicle. The necessary adjustments can be performed in vehicles with a driver information system »» page 26.

General information

If a valid key is located in the proximity of the car »» **Fig. 123 A**, the Keyless Access locking and ignition system gives the key entry as soon as one of the sensor surfaces on the door handles is touched or the *soft-touch*/handle on the rear lid is operated. The following features are then available without having to use the vehicle key actively:

- **Keyless-Entry:** unlocking the vehicle using the handles of the front doors or the *soft-touch*/handle on the rear lid.
- **Keyless-Exit:** locking the vehicle using the sensor of the driver or passenger door handle.
- **Easy Open:** opening the rear lid moving one foot below the rear bumper.

- **Press & Drive:** keyless starting of the engine with the starter button » page 165.

The central locking and locking systems operate in the same way as a *normal* locking and unlocking system. Only the controls change.

Unlocking the vehicle is confirmed with a *double* flash of the indicator lights; locking by a *single* flash.

If the vehicle is locked and then all doors and the rear lid are closed leaving the last key used inside the vehicle and none outside, the vehicle will **not** lock **immediately**. All the vehicle's indicator lights will flash *four times*. The vehicle will lock again after a few seconds if you fail to open any door or the rear lid.

If you unlock the vehicle but fail to open any door or the rear lid, the vehicle will lock again after a few seconds.

Unlocking and opening the doors (Keyless-Entry)

- Hold one of the front door handles. In doing this, the sensor surface » Fig. 124 **A** (arrow) is touched on the handle and the vehicle unlocks.
- Open the door.

On vehicles with selective opening or infotainment system configuration, pulling the door handle twice will unlock all doors.

On vehicles without a “Safe” system: locking and unlocking doors (Keyless-Exit)

- Switch the ignition off.
- Close the driver's door.
- Touch the locking sensor surface **B** (arrow) of the handle of one of the front doors *once*. The door being operated must be closed.

On vehicles with a “Safe” system: locking and unlocking doors (Keyless-Exit)

- Switch the ignition off.
- Close the driver's door.
- Touch the sensor surface **B** (arrow) of the handle of one of the front doors *once*. The vehicle locks with the “Safe” system » page 119. The door being operated must be closed.
- Touch the sensor surface **B** (arrow) of the handle of one of the front doors *twice* to lock the vehicle without activating the “Safe” security system » page 119.

Unlocking and locking the rear lid

When the vehicle is locked, the rear lid automatically unlocks on opening if » Fig. 123 **A** there is a valid vehicle key in the proximity.

Open or close the rear lid *normally*.

After closing, the rear lid locks automatically. If the complete vehicle is unlocked, the rear lid will **not** lock automatically after closing it.

Opening the rear lid with sensor-controlled opening (Easy Open)

If there is a valid vehicle key in the proximity of » Fig. 123 **A** the rear lid, it is possible to unlock and open or close it moving one foot in the area of the sensors » Fig. 123 **B** located under the rear bumper.

- Switch the ignition off.
- Stand in front of the rear bumper, in the middle.
- With a brisk movement, bring your foot and lower leg as close as you can to the bumper. The lower part of the leg needs to be close to the upper sensor area and your foot to the lower sensor area » Fig. 123 **B** **1**.
- Quickly remove your foot and lower leg from the sensor areas » Fig. 123 **B** **2**. The rear lid opens automatically.
- If the rear lid fails to open, repeat the procedure after a few seconds.

The third brake light flashes once to show the boot has opened with the Easy Open function.

The rear lid can be closed with another foot movement similar to the opening one (provided a valid vehicle key is in the proximity of the rear lid).


When closed, the rear lid automatically locks if the vehicle has been locked beforehand and there is no valid key inside. »

While the rear lid is in motion (either opening or closing), it can be stopped with another foot movement similar to the opening one (provided a valid vehicle key is in the proximity of the rear lid).

The Easy Open feature is not available or only has limited availability in the following situations (examples):


- If the rear bumper is very dirty.
- If the rear bumper is wet with salt water, e.g. after having driven on gritted roads.
- If the electrical unlocking tow hitch is not covered.
- If the vehicle has been equipped at a later time with a tow bracket.

In the event of heavy rain, the Easy Open feature may take a little longer to open the boot or automatically disable to avoid the boot opening by accident, e.g. when the rain falls.

The Easy Open function may be connected and disconnected permanently in the infotainment system by pressing the **CAR** **SETUP** and **Opening and closing**  **page 26** function buttons.

What happens when locking the vehicle with a second key

If there is a vehicle key inside the vehicle and it is locked from the outside with a second vehicle key, the key inside the vehicle is blocked for engine ignition **» page 165**. In


order to enable engine ignition, the button on the key  inside the vehicle needs to be pressed.

Automatically disabling sensors


If the vehicle is not locked or unlocked for a long period of time, the proximity sensors on the passenger doors are automatically disabled.

If one of the sensor surfaces on the door handles is often activated in a unusual manner with the vehicle locked (e.g. by the branches of a bush rubbing against it), all proximity sensors are disabled for a certain period of time.

Sensors will again be enabled:

- After a time.
- **OR:** if the vehicle is unlocked with the button  on the key.
- **OR:** if the rear lid is open.
- **OR:** if the vehicle is unlocked manually with the key.

Convenience functions

To **close** all the electric windows and the glass roof **using the convenience function**, keep a finger for a few seconds on the locking sensor surface **» Fig. 124**  (arrow) of the door handle until the windows and roof have closed.

The doors may be opened by touching the sensor surface of the door handle depending on the settings that have been activated in the infotainment system with the **CAR** **SETUP** and **Opening and closing** function buttons.

WARNING

If there is a valid key in the proximity of the rear lid, in some cases the Easy Open function may be accidentally turned on and the rear lid will open, for example, when sweeping under the rear bumper, when directing a water jet or high pressure steam to the area or when carrying out maintenance work or repairs in that area. If accidentally opened, the rear lid could injure somebody situated in its area of operation or cause material damage.

- Therefore, always make sure that there is no unsupervised valid key in the area near the rear lid.
- Before carrying out any maintenance or repair work on the vehicle, always disable the Easy Open feature on the infotainment system.
- Before washing the vehicle, always disable the Easy Open feature on the infotainment system.
- Before attaching a bicycle rack or a trailer **» page 255**, always disable the Easy Open feature on the information system.

ⓘ CAUTION

The sensor surfaces on the door handles could engage if hit with a water jet or high pressure steam if there is a valid vehicle key in the proximity. If at least one of the windows is open and the sensor surface **(B)** on one of the handles permanently activates, all windows will close. If the water jet or steam is briefly moved away from the sensor surface **(A)** (arrow) on one of the handles and then pointed at it again, all the windows will probably open » page 118.

ⓘ Note

- If the vehicle battery has little or no charge, or the vehicle key battery is almost or entirely out of charge, you will probably not be able to lock or unlock the vehicle with the Keyless Access system. The vehicle can be unlocked or locked manually » page 85.
- To control the proper locking of the vehicle, the release function is disabled for approx. 2 seconds.
- If the message **Keyless access system fault** is displayed on the screen of the dash panel, abnormalities may occur in the operation of the Keyless Access system. Contact a specialised workshop. SEAT recommends visiting a SEAT dealership for this.
- Depending on the function set on the infotainment system for the mirrors, the exterior mirrors will unfold and the surround lighting will come on when unlocking the vehicle us-


ing the sensor surface on the driver and passenger door handles » page 141.

- If there is no valid key inside the vehicle or the system fails to detect one, a warning will display on the dash panel screen. This could happen if any other radio frequency signal interferes with the key signal (e.g. from a mobile device accessory) or if the key is covered by another object (e.g. an aluminium case).
- If the sensors are very dirty, e.g. have a layer of salt, how the sensors on the door handles operate may be affected. In this case, clean the vehicle.
- If the vehicle is equipped with an automatic gearbox, it may only be locked in the gear stick is in position P.

Anti-theft security system (Safelock)*

The following message is displayed on the instrument panel to remind the driver that when the vehicle is closed from the outside, the anti-theft security system is switched on. **⚠ Do not forget the Safelock. Please see Instruction Manual.** The vehicle cannot be opened from inside. This makes it more difficult for unauthorised persons to break into the vehicle » **⚠** in Description on page 112.

The anti-theft security system can be switched off each time the vehicle is locked:

- Turn the key a second time to the lock position, in the door lock, **within two seconds**. If necessary, remove the protective cover on the driver door handle »  page 9 or else
- Press **(A)** on the remote control key for a second time **within 2 seconds**.

The flashing frequency of the diode in the door sill immediately confirms the process. Initially, the diode flashes in a fast sequence for a brief period, then it stops for approximately 30 seconds and, lastly continues flashing slowly.

Replacing the battery

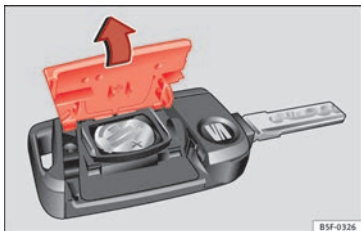


Fig. 125 Vehicle key: opening the battery compartment

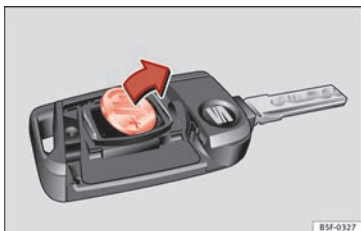


Fig. 126 Vehicle key: removing the battery

SEAT recommends you ask a specialised workshop to replace the battery.

The battery is located to the rear of the vehicle key, under a cover.

Changing the battery

- Unfold the vehicle key blade » page 113.
- Remove the cover from the back of the vehicle key » Fig. 125 in the direction of the arrow » ①.
- Extract the battery from the compartment using a suitable thin object » Fig. 126.
- Place the new battery in the compartment as shown » Fig. 126, pressing in the opposite direction to that shown by the arrow » ②.
- Fit the cover as shown » Fig. 125, pressing it onto the vehicle key casing in the opposite direction to that shown by the arrow until it clicks into place.

ⓘ CAUTION


- If the battery is not changed correctly, the vehicle key may be damaged.
- Use of unsuitable batteries may damage the vehicle key. For this reason, always replace the dead battery with another of the same voltage, size and specifications.
- When fitting the battery, check that the polarity is correct.





For the sake of the environment

Please dispose of your used batteries correctly and with respect for the environment.

Synchronising the vehicle key

If the button  is pressed frequently outside of the vehicle range, it is possible that the vehicle can no longer be locked or unlocked using the key. In this case, the key must be re-synchronised as described below:

- Unfold the vehicle key blade » page 113.
- If necessary, remove the cover from the driver door lever »  page 9.
- Press the button  on the vehicle key. For this, it must remain with the vehicle.
- Open the vehicle within one minute using the key blade. The key has been synchronised.
- If necessary, fit the cap.

Childproof lock

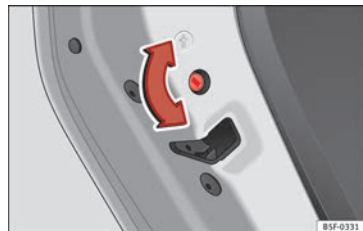


Fig. 127 Childproof lock on the left hand side door.

The childproof lock prevents the rear doors from being opened from the inside. This system prevents minors from opening a door accidentally while the vehicle is running.

This function is independent of the vehicle electronic opening and locking systems. It only affects rear doors. It can only be activated and deactivated manually, as described below:

Activating the childproof lock

- Unlock the vehicle and open the door in which you wish to activate the childproof lock.
- With the door open, rotate the groove in the door using the ignition key, clockwise for the left hand side doors » **Fig. 127** and anti-clockwise for the right hand side doors.

Deactivating the childproof lock

- Unlock the vehicle and open the door whose childproof lock you want to deactivate.
- With the door open, rotate the groove in the door using the ignition key, anti-clockwise for the left hand side doors » **Fig. 127** and clockwise for the right hand side doors.

Once the childproof lock is activated, the door can only be opened from the outside.

The childproof lock can be activated or deactivated by inserting the key in the groove when the door is open, as described above.

Anti-theft alarm system*

Description

The anti-theft alarm makes it more difficult to break into the vehicle or steal it.

The anti-theft alarm is automatically turned on when the vehicle is locked with the key.

- The turn signal light will flash twice on opening and deactivating the alarm.
- The turn signal light will flash once on closing and activating the alarm.

When does the system trigger an alarm?

The anti-theft alarm siren will be triggered for about 30 seconds accompanied by sound and optical (flashing) warning signals and will be repeated about ten times when the vehicle is locked and the following unauthorised actions are attempted:

- Opening a door that is mechanically unlocked using the vehicle key without switching on the ignition in the next 15 seconds (in certain markets, such as the Netherlands, there is no 15 second waiting time and the

alarm is activated immediately on opening the door).

- A door is opened.
- The bonnet is opened.
- The rear lid is opened.
- When the ignition is switched on with a non-authorised key.
- When the vehicle battery is disconnected.
- Movement inside the vehicle (in vehicles with interior monitoring » **page 123**).
- When the vehicle is towed (in vehicles with anti-tow system » **page 123**).
- When the vehicle is raised (in vehicles with anti-tow system » **page 123**).
- When the vehicle is transported on a ferry or by rail (vehicles with an anti-tow system or vehicle interior monitoring » **page 123**).
- When a trailer connected to the anti-theft alarm system is disconnected.


How to turn OFF the alarm

Unlock the vehicle with the unlocking button on the key or turn on the ignition with a valid key.

Note

- **After 28 days, the indicator light will be switched off to prevent the battery from exhausting if the vehicle has been left parked** »

for a long period of time. The alarm system remains activated.

- If, after the audible warning goes off, another monitored area is accessed (e.g. the rear lid is opened after a door has been opened), the alarm is triggered again.
- The anti-theft alarm is not activated when the vehicle is locked from within using the central locking button .
- If the driver door is unlocked mechanically with the key, only the driver door is unlocked, the rest of the doors remain locked. Only when the ignition has been turned on will the other doors be available - but not unlocked - and the central locking button will be activated.
- If the vehicle battery is run down or flat then the anti-theft alarm will not operate correctly.
- Vehicle monitoring remains active even if the battery is disconnected or not working for any reason.
- The alarm is triggered immediately if one of the battery cables is disconnected while the alarm system is active.



Vehicle interior monitoring and anti-tow system*

It is a monitoring or control function incorporated in the anti-theft alarm* which detects unauthorised vehicle entry by means of ultrasound.

Activation

- It is automatically switched on when the anti-theft alarm is activated.

Deactivation

- Open the vehicle with the key, either mechanically or by pressing the  button on the remote control. The time period from when the door is opened until the key is inserted in the contact should not exceed 15 seconds, otherwise the alarm will be triggered.
- Press the button  on the remote control twice. The volumetric sensor and tilt sensors will be deactivated. The alarm system remains activated.

The vehicle interior monitoring and the anti-tow system are automatically switched on again next time the vehicle is locked.

The vehicle interior monitoring and anti-tow sensor (tilt sensor) are automatically switched on when the anti-theft alarm is switched on. In order to activate it, all the doors and the rear lid must be closed.

If you wish to switch off the vehicle interior monitoring and the anti-tow system, it must be done each time that the vehicle is locked; if not, they will be automatically switched on.

The vehicle interior monitoring and the anti-tow system should be switched off if animals are left inside the locked vehicle (otherwise,

their movements will trigger the alarm) or when, for example, the vehicle is transported or has to be towed with only one axle on the ground.

False alarms

Interior monitoring will only operate correctly if the vehicle is completely closed. Please observe related legal requirements.

The following cases may cause a false alarm:

- Open windows (partially or fully).
- Panoramic/tilting sunroof open (partially or completely).
- Movement of objects inside the vehicle, such as loose papers, items hanging from the rear vision mirror (air fresheners), etc.

Note

- **If the vehicle is relocked and the alarm is activated without the volumetric sensor function, relocking will activate the alarm with all its functions, except the volumetric sensor. This function is reactivated when the alarm is switched on again, unless it is deliberately switched off.**
- **If the alarm has been triggered by the volumetric sensor, this will be indicated by a flashing of the warning lamp on the driver door when the vehicle is opened. The flash is different to the flash indicating the alarm is activated.**

- The vibration of a mobile phone left inside the vehicle may cause the vehicle interior monitoring alarm to trigger, as both sensors react to movements and shakes inside the vehicle.
- If on activating the alarm, any door or the rear lid is open, only the alarm will be activated. The vehicle interior monitoring and the anti-tow system will only be activated once all the doors are closed (including the rear lid).

Deactivating the vehicle interior monitoring and anti-tow systems*



Fig. 128 Vehicle interior monitoring/tow-away protection button.

When the vehicle is locked, the alarm will be triggered if movements are detected in the interior (e.g. by animals) or if the vehicle's inclination is changed (e.g. during transport). You can prevent the alarm from being trig-

gered accidentally by switching off the vehicle interior monitoring and/or tow-away protection.

- To switch off the vehicle interior monitoring and tow-away protection, switch off the ignition and press button **»» Fig. 128**. The indicator on the button will light up.
- When the vehicle is locked now, the vehicle interior monitoring and the tow-away protection are switched off until the next time the door is opened.

If the anti-theft security system (Safelock)* **»» page 119** is switched off, the vehicle interior monitoring and the tow-away protection are automatically switched off.

⚠ WARNING

Observe the safety warnings »» ⚠ in Description on page 112.

Rear lid (luggage compartment)

Rear lid with electric opening and closing*



Fig. 129 Rear lid open: button to close the rear lid immediately.

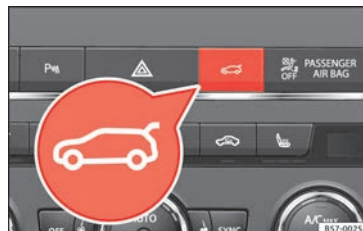








Fig. 130 Centre console: button to open and close rear lid. **»»**


 » table on page 2
Open rear lid

- Unlock the vehicle » page 112 and briefly press the handle of the rear lid. On vehicles with Keyless Access you can directly press the handle of the rear lid. The rear lid is unlocked if an authorised key in the proximity of the vehicle is recognised.
- **OR:** press the button on the centre console for at least one second » Fig. 130. The button also works when the ignition is switched off.
- **OR:** press and hold  the vehicle key button for approx. 1 second. If the vehicle is locked, unlock the rear lid only (the doors remain locked).
- **OR:** on vehicles with Keyless Access and controlled opening sensors you can open the rear lid by moving one foot in the area of the sensors located below the rear bumper (Easy Open). The rear lid opens automatically.


Closing luggage lid

- Briefly press the  button on the rear lid » Fig. 129 » .
- **OR:** press the  button located on the centre console until the rear lid is closed » Fig. 130.
- **OR:** on vehicles with Keyless Access, press and hold the  vehicle key button until the rear lid is closed or move one foot in the area


of the sensors located below the rear bumper (Easy Open) » page 116. The vehicle key must not be further than approx. 1.5 m from the luggage compartment and should not be in the vehicle.

- **OR:** move the rear lid with the hand in the direction of closing until it closes automatically.
- The rear lid goes down automatically to the final position and also closes automatically » .

Interrupting opening or closing

After beginning to open or close the rear lid, the action can be halted by pressing one of the  buttons.

Continue opening or closing the rear lid by hand. To do this, some force will have to be used.

If you press one of the  buttons again, the rear lid will move again in the exit direction.

If the rear lid finds resistance or an obstacle during the automatic opening or closing, opening or closing will be interrupted immediately. For the closing process, the rear lid opens again slightly.

- Check why it has not been possible to open or close the rear lid.
- Try to open or close the rear lid again.

- If necessary, the rear lid can be opened or closed by hand using reasonable force.

Special feature for pulling a trailer

If the factory-fitted towing bracket is electrically connected to a trailer » page 255, the electric rear lid can only be opened or closed with the keys available within it.


Acoustic warnings

Throughout the process of opening or closing the rear lid, audible warnings can be heard. Exception: when the rear lid is opened manually using the handle or the Easy Open function with the movement of the foot or closed using the button available within it » Fig. 129.

Modifying and memorising the opening angle

If the space behind or above the vehicle is less than the travel area of the rear lid, you can change the opening angle of the rear lid.


To memorise a new opening angle, the rear lid must be open at least halfway.

- Interrupt the opening process in the desired position.
- Press the  » Fig. 129 button available in the rear lid for at least 3 seconds.

The opening angle is memorised. Memorisation is indicated by blinking of the hazard warning lights and an audible warning.

Resetting and memorising the opening angle

For the rear lid to reopen completely, the opening angle must be reset and memorised again.

- Release the rear lid and open it to the memorised height.
- Lift the rear lid by hand until it stops. To do this, some force will have to be used.
- Press the  **Fig. 129** button available in the rear lid for at least 3 seconds.
- This resets and memorises the factory-set opening angle. Memorisation is indicated by blinking of the hazard warning lights and an audible warning.

Automatic protection against overheating

If the system is operated repeatedly in a short space of time, it automatically switches off to prevent overheating.

Once the system is cool again, the function can be reused. Until then the rear lid can only be opened and closed by hand using reasonable force.

If with the rear lid open the vehicle battery is disconnected **» page 289** or the corresponding fuse burns out **» page 90**, the sys-

tem will have to be reset. This requires closing the rear lid completely once.

Emergency unlocking

»  **page 11**

WARNING

If a lot of snow builds up on the rear lid or it is heavily loaded, the rear lid may not open or, after opening, it may lower by itself due to the extra weight and cause serious injury.

- **Never open the rear lid when there is a lot of snow on it or when carrying a load (e.g. on a rack).**
- **Before opening the rear lid, remove the snow or the load.**

WARNING

If the rear lid is closed incorrectly or without due care, it could result in serious injury.


- **Never leave the vehicle unattended or allow children to play inside or next to it, especially if the rear lid is open. Children could enter the luggage compartment, close the rear lid and become trapped. A locked vehicle can reach extremely high and low temperatures, depending on the time of year, thus causing serious injuries, illness or even death.**


CAUTION

Before opening or closing the rear lid, make sure that there is enough space to open or


close it, e.g. when pulling a trailer or in a garage.

Tailgate automatic lock


Where the vehicle has been locked by pressing the  button on the remote control with the rear lid open, the rear lid will lock automatically when closed.

The automatic tailgate locking time extension function can be activated. Where this function is activated and once the rear lid has been unlocked by pressing the  button on the remote control key **» page 114**, the rear lid can be re-opened for a certain length of time.

Where required, the automatic tailgate locking time extension function can be activated or deactivated at an Authorised SEAT Service, which will provide all the necessary information.

Before the vehicle locks automatically, there is a risk of intruders getting into the vehicle. Therefore, we recommend you always lock the vehicle by pressing the  button on the remote control or by using the central locking button.

WARNING

Observe the safety warnings **»  in Introduction on page 85.**

- Always close the rear lid properly. Risk of accident or injury.
- The rear lid must not be opened when the reverse or rear fog lights are lit. This may damage the tail lights.
- Do not close the rear lid by pushing it down with your hand on the rear window. The glass could smash. Risk of injury!
- Ensure the rear lid is locked after closing it. If not, it may open unexpectedly while driving.
- Closing the rear lid without observing and ensuring it is clear could cause serious injury to you and to third parties. Make sure that no one is in the path of the rear lid.
- Never drive with the rear lid open or half-closed, exhaust gases may penetrate into the interior of the vehicle. Danger of poisoning!
- If you only open the rear lid, do not leave the key inside. The vehicle cannot be opened if the key is left inside.

Electric windows

Electric opening and closing of windows

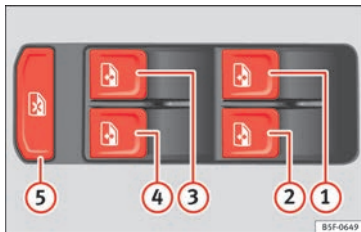


Fig. 131 Detail of the driver door: controls for the windows.

Read the additional information carefully

» page 12

The front and rear electric windows can be operated by using the controls on the driver door. The other doors each have a switch for their own window.

Always close the windows fully if you park the vehicle or leave it unattended » **A**.

You can use the electric windows for approx. 10 minutes after switching off the ignition if neither the driver door nor the front passenger door has been opened and the key has not been removed from the ignition.

Safety switch

Safety switch on the driver door can be used to disable the electric window buttons in the rear doors.

Safety switch not pressed: buttons on rear doors are activated.

Safety switch pressed: buttons on rear doors are deactivated.

The safety control symbol lights up in yellow if the buttons on the rear doors are switched off.

WARNING

Observe the safety warnings » in Introduction on page 85.

- Incorrect use of the electric windows can result in injury.
- Never close the rear lid without observing and ensuring it is clear, to do otherwise could cause serious injury to you and third parties. Make sure that no one is in the path of a window.
- If the ignition is switched on, the electric equipment could be activated with risk of injury, for example, in the electric windows.
- The doors can be locked using the remote control key. This could become an obstacle for assistance in an emergency situation.
- Therefore always take the key with you when you leave the vehicle.

- The electric windows will work until the ignition has been switched off and one of the front doors has been opened.
- If necessary, use the safety switch to disable the rear electric windows. Make sure that they have been disabled.

Note

If the window is not able to close because it is stiff or because of an obstruction, the window will automatically open again »» page 127. If this happens, check why the window could not be closed before attempting to close it again.

Roll-back function

The roll-back function reduces the risk of injury when the electric windows close.

- If a window is obstructed when closing automatically, the window stops at this point and lowers immediately »» ⚠.
- Next, check why the window does not close before attempting it again.
- If you try within the following 10 seconds and the window closes again with difficulty or there is an obstruction, the automatic closing will stop working for 10 seconds.
- If the window is still obstructed, the window will stop at this point.

- If there is no obvious reason why the window cannot be closed, try to close it again by pulling the tab within ten seconds. The window closes with maximum force. **The roll-back function is now deactivated.**
- If more than 10 seconds pass, the window will open fully when you operate one of the buttons. One-touch closing is reactivated.

⚠ WARNING



Observe the safety warnings »» ⚠ in Electric opening and closing of windows on page 126.

- The roll-back function does not prevent fingers or other parts of the body getting pinched against the window frame. Risk of accident.

Convenience opening/closing


Use the convenience opening/closing function to easily open/close all the windows and the sliding/tilting sunroof* from the outside.

Convenience open function


- Press and hold button  on the remote control key until all the windows and the sliding/tilting sunroof* have reached the desired position, or
- First unlock the vehicle using button  on the remote control key and then keep the key in the driver door lock until all the win-

dows and the sliding/tilting sunroof* have reached the required position.

Convenience close function

- Press and hold button  on the remote control key until all the windows and the sliding/tilting sunroof* are closed »» ⚠, or
- Keep the key in the driver door in the "lock" position until all the windows and the sliding/tilting sunroof* are closed.

Programming convenience opening in the Easy Connect*

- Select: function button  > control button **Vehicle systems*** > **Vehicle settings** > **Central locking** > **Open the window by holding button down** or else > **Front window on/off** or else **Roof on/off***.

⚠ WARNING

- Take care when closing the sliding/tilting sunroof* and windows. There is a risk of suffering injury.
- For safety reasons, you should only use the remote control open and close functions within about 2 metres of the vehicle. To avoid injuries, always keep an eye on the windows and the sliding/tilting sunroof* when pressing the button to close them. The windows stop moving as soon as the button is released.

One-touch opening and closing

One-touch opening and closing means you do not have to hold down the button.

Buttons » Fig. 131 ①, ②, ③ and ④ have two positions for opening windows and two for closing them. This makes it easier to open and close windows to the desired position.

One-touch closing

– Pull up the window button briefly up to the second position. The window closes fully.

One-touch opening

– Push down the window button briefly up to the second position. The window opens fully.

Resetting one-touch opening and closing

The automatic open and close function will not work if the battery has been temporarily disconnected. The function can be restored as follows:

- Close the window as far as it will go by lifting and holding the electric window switch.
- Release the switch and then lift it again for 1 second. This will re-enable the automatic function.

If you push (or pull) a button to the first stage, the window will open (or close) until you release the button. If you push or lift the

button briefly to the second stage, the window will open (one-touch opening) or close (one-touch closing) automatically. If you operate the button while the window is opening or closing, it stops at this position.

Sunroof*

Introduction

The sunroof consists of two glass parts. The rear part is fixed and cannot be opened. It also has a sun blind.

WARNING

If the sunroof is used negligently or without paying due attention, it can cause serious injury.


- Open or close the sunroof and the sun blind only when no one is in their path of movement.
- Never leave any key inside the vehicle when exiting.
- Never leave a child or any other person who may need help in the vehicle, especially if they have access to the vehicle key. If using they key unattended, they could lock the vehicle, start the engine, switch on the ignition and activate the sunroof.
- After switching off, it is still possible to open or close the sunroof during a short

space of time provided that neither the driver nor passenger door is opened.

CAUTION

- To prevent damage, during winter temperatures remove any ice or snow that might be on the car roof before opening the sunroof or adjusting the tilt position.
- Before leaving the vehicle or in case of rainfall, always close the sunroof. With the sunroof open or in a tilted position, water can enter the interior and can cause considerable damage to the electrical system. As a result, other damage can occur in the vehicle.

Note

- Leaves and other loose objects that accumulate on the sunroof rails should be regularly cleaned away either by hand or with a vacuum.
- If the sunroof does not work correctly, the anti-trap function will not work either. Contact a specialised workshop.
- Some settings can be saved in user accounts of the personalisation function »  page 26.

Opening and closing the sunroof

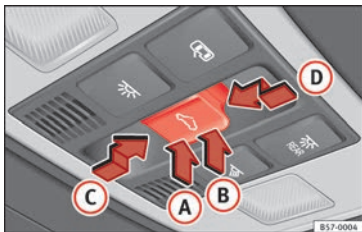



Fig. 132 On the interior roof lining: sunroof button.

The sunroof only works when the ignition is switched on. Once the ignition has been switched off, you can still open or close the sunroof for a few minutes provided the driver door and the front passenger door are not opened.

The sun blind automatically opens along with the sunroof if completely closed or if in front of the sunroof. The sun blind remains in the previous position and does not automatically close with the sunroof. The sun blind can only be closed completely once the sunroof has been closed.

The button  **Fig. 132** has two levels. The first level switches the sunroof to the tilted position, opening or closing it fully or partially.

On the second level, the sunroof automatically moves to the corresponding final position after briefly pressing the button. Activating the button again stops the automatic function.

Adjusting the tilt position of the sunroof

- Press the rear part of the button **(B)** to the first level.
- Automatic operation: briefly press the rear part of button **(B)** to the second level.

Closing the sunroof from a tilted position

- Press the front part of the button **(A)** to the first level.
- Automatic operation: briefly press the front part of the button **(A)** to the second level.

Stopping the automatic operation by adjusting the tilted position of the sunroof or by closing the sunroof

- Press button **(A)** or **(B)** again.

Opening the sunroof

- Press button **(C)** backwards to the first level.
- Automatic operation to comfort position: briefly press button **(C)** backwards to the second level.

Closing the sunroof

- Press button **(D)** forwards to the first level.
- Automatic operation: briefly press button **(D)** forwards to the second level.

Stopping the automatic operation during the opening or closing

- Press button **(C)** or **(D)** again.

Opening and closing the sun blind

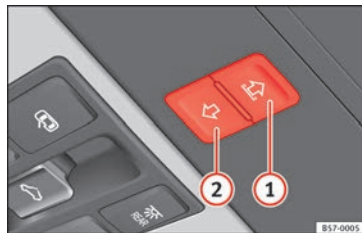


Fig. 133 On the interior roof lining: switches for the sun blind.

The electrical sun blind works when the ignition is switched on.

When the sunroof is in its most tilted position, the sun blind automatically goes into a ventilation position. The sun blind remains in this position also with the sunroof closed. »

Buttons **»» Fig. 133 ① and ②** have two levels. The first level opens or closes the sun blind fully or partially.

By briefly pressing the button to the second level, the sun blind automatically moves to the corresponding final position. Activating the button again stops the automatic function.

Once the ignition has been switched off, you can still open or close the sun blind for a few minutes provided the driver door and the front passenger door are not opened.

Opening the sun blind

- Press button **①** to the first level.
- Automatic operation: briefly press button **①** to the second level.

Closing the sun blind

- Press button **②** to the first level.
- Automatic operation: briefly press button **②** to the second level.

Stopping the automatic operation during the opening or closing

- Press button **①** or **②** again.

Note

When the sunroof is open, the electric sun blind can only be closed to the front edge of the sunroof.

Anti-trap function of the panoramic sliding sunroof and the sun blind

The anti-trap function can reduce the risk of injury when closing the sunroof and the sun blind **»» ⚠**. If the sunroof or sun blind encounter resistance or an obstacle when closing, they reopen immediately.

- Check why the sunroof or sun blind do not close.
- Try to close the sunroof or sun blind again.
- If the sunroof or sun blind cannot be closed due to an obstacle or some resistance, it stops at the corresponding position and then opens. For automatic closing, a new closing attempt might take place.
- If the sunroof or sun blind is still unable to close, close it without the anti-trap function.

Closing the sunroof or sun blind without the anti-trap function

- *Sunroof*: within approx. 5 seconds of having activated the anti-trap function, press the button **☁»» Fig. 132** to the second level in the direction of arrow **»» Fig. 132 ①** until the sunroof closes completely.
- *Sun blind*: within approx. 5 seconds of having activated the anti-trap function, press button **»» Fig. 133 ②** until the sun blind closes completely.
- **The sunroof or sun blind close without the anti-trap function intervening!**

- If the sunroof or sun blind will still not close, visit a specialised workshop.

WARNING

Closing the sunroof or sun blind without the anti-trap function can cause serious injuries.

- **Always be careful when closing the sunroof and sun blind.**
- **No person should ever remain in the way of the sunroof or sun blind, especially when closing without the anti-trap function.**
- **The anti-trap function does not prevent fingers or other parts of the body from becoming trapped against the roof frame and injuries occurring.**

Lights and visibility

Lights

Side light and dipped beam headlight

Read the additional information carefully



»  page 23

The legal requirements regarding the use of vehicle lights in each country must be observed.

The driver is personally responsible for the correct use and adjustment of the lights in all situations.

Audible warnings to advise the driver that the lights have not been switched off

If the key is not in the ignition and the driver door is open, an audible warning signal is heard in the following cases: this is a reminder to turn off the lights.

- When the parking light is on » page 131.
- When the light switch is in position  or .

WARNING

The side lights or daytime running lights are not bright enough to illuminate the road ahead and to ensure that other road users are able to see you.


- Always use your dipped beam head lights if it is raining or if visibility is poor.

WARNING

If the headlights are set too high and not used correctly, there is a risk of dazzling or distracting other road users. This could result in a serious accident.

- Always make sure that the headlights are correctly adjusted.

Daytime running lights

The daytime running lights consist of individual lights, integrated in the front headlights. By connecting the daytime running lights, these lights are switched on¹⁾ » .

The daytime running lights switch on every time the ignition is switched on, if the switch is in positions **0** or **AUTO**, according to the level of exterior lighting.

When the light switch is in position **AUTO**, a light sensor automatically switches dipped beam on and off (including the control and instrument lighting) or the daytime running lights depending on the level of exterior lighting.

WARNING

- Never drive with daytime lights if the road is not well lit due to weather or lighting conditions. Daytime lights do not provide enough light to illuminate the road properly or be seen by other road users.
- On vehicles with rear lights with bulbs, when activating the daytime running light the rear lights are not switched on. A vehicle which does not have the rear lights on may not be visible to other drivers in the darkness, in the case of heavy rain or in conditions of poor visibility.

Turn signal and main beam lever

Read the additional information carefully

»  page 24

Push the lever all the way down to turn off the corresponding function. »

¹⁾ On vehicles equipped with rear LED lights, the rear side light is switched on as well.

Convenience turn signals

For the convenience turn signals, move the lever as far as possible upwards or downwards and release the lever. The turn signal will flash three times.

The convenience turn signals are activated and deactivated in the Easy Connect system via the **(CAR)** key and the **(Setup)** function button » page 108.

In vehicles that do not have the corresponding menu, this function can be deactivated in a specialised workshop.

WARNING

Improper or lack of use of the turn signals, or forgetting to deactivate them can confuse other road users. This could result in a serious accident.

- Always give warning when you are going to change lane, overtake or when turning, activating the turn signal in good time.
- As soon as you have finished changing lane, overtaking or turning, switch the turn signal off.

WARNING

Incorrect use of the headlights may cause accidents and serious injury, as the main beam may distract or dazzle other drivers.


Note

- If the convenience turn signals are operating (three flashes) and the other convenience turn signals are switched on, the active part stops flashing and only flashes once in the new part selected.
- The turn signal only works when the ignition is switched on. The hazard warning lights also work when the ignition is switched off.
- If a trailer turn signal malfunctions, the control lamp will stop flashing (trailer turn signals) and the vehicle turn signal will flash at double speed.
- The main beam headlights can only be switched on if the dipped beam headlights are already on.
- In cold or damp weather conditions, the headlights, tail lights and turn signals may mist up inside temporarily. This is normal and in no way affects the useful life of the vehicle lighting system.

Automatic dipped beam control AUTO*

The automatic dipped beam control is merely intended as an aid and is not able to recognise all driving situations.

When the light switch is in position **AUTO**, the vehicle lights and the instrument panel and switch lighting switch on and off automatical-

ly in the following situations »  in Daytime running lights on page 131:

Automatic switching on	Automatic switching off
The photo sensor detects darkness, for example, when driving through a tunnel.	When adequate lighting is detected.
The rain sensor detects rain and activates the windscreen wipers.	When the windscreen wipers have been inactive for a few minutes.


WARNING

If the road is not well lit and other road users cannot see the vehicle well enough or at all, accidents may occur.

- The automatic dipped beam control (AUTO) only switches on the dipped beam when there are no changes in brightness, and not, for example when it is foggy.

Main beam assist*



Main beam assist (Light Assist)

The main beam assist acts within the limits of the system and depending on environmental and traffic conditions. Once switched on, the system is activated as of a speed of about 60 km/h (37 mph) and is deactivated below about 30 km/h (18 mph) » .

When the system is activated and the camera detects other vehicles that may be dazzled, the main beam is automatically switched off. Otherwise, the main beam is automatically switched on.

The main beam assist generally detects illuminated areas and deactivates the main beam when passing through a town, for example.

Switching the main beam assist on and off

Function	Use
Activate: 	– Switch the ignition on and turn the light switch to position AUTO . – From the base position, move the main beam and turn signal lever forwards » page 131. When the warning lamp  is displayed on the instrument panel display, the main beam assist is switched on.
To switch system off:	– Switch off the ignition. – OR: turn the light switch to a different position to AUTO » page 131. – OR: with main beam on, move the main beam and turn signal lever backwards. – OR: move the main beam and turn the signal lever forwards to manually switch the main beam on. The main beam assist will then be deactivated.

Malfunctions

The following conditions may prevent the main beam headlight control from turning off

the headlights in time or from turning off altogether:

- In poorly lit towns with highly reflective signs.
- Other insufficiently lit road users (such as pedestrians or cyclists).
- On tight bends and steep slopes (bumps) and when oncoming vehicles are partially obscured.
- When the drivers of other oncoming vehicles (such as a truck) can see over a guard rail in the centre of the road.
- If the camera is damaged or the power supply is cut off.
- In fog, snow and heavy rain.
- With dust and sand turbulence.
- With loose gravel in the field of vision of the camera.
- When the field of vision of the camera is misted up, dirty or covered by stickers, snow, ice, etc.

WARNING

The convenience features of the main beam assist should not encourage the taking of risks. The system is not a replacement for driver concentration.

- You are always in control of the main beam and adapting it to the light, visibility and traffic conditions.

- It is possible that the main beam headlight control does not recognise all driving situations and is limited under certain circumstances.

- When the field of vision of the camera is dirty, covered or damaged, operation of the main beam control may be affected. This also applies when changes are made to the vehicle lighting system, for example, if additional headlights are installed.

CAUTION

To avoid affecting the operation of the system, take the following points into consideration:

- Clean the field of vision of the camera regularly and make sure it is free of snow and ice.
- Do not cover the field of vision of the camera.
- Check that the windscreen is not damaged in the area of the field of vision of the camera.

Note

Main beam and headlight flasher can be turned on and off manually at any time with the turn signal and main beam lever » page 131.

Fog lights



Fig. 134 Dash panel: light control.

The warning lamps ☾ or ☽ also show, on the light switch or instrument panel, when the fog lights are on.

- Switching on front fog lights* ☾ : pull the light switch to the first point \ggg Fig. 134 ①, from positions ☽ , ☾ or **AUTO**.
- Switching on the rear fog light ☽ : completely pull the light switch ② from position ☽ , ☾ or **AUTO**.
- To switch off the fog lights, press the light switch or turn it to position **0**.

Cornering lights*¹⁾

When turning slowly or on very tight bends, the cornering lights are activated automatically. The cornering lights may be integrated in the fog lights and are switched on only at speeds of less than 40 km/h (25 mph).

When reverse gear is engaged, the cornering lights on both sides of the vehicle switch on, in order to better illuminate the area for parking.

Function “Coming home”

 \ggg table on page 2

This function may be connected/disconnected through the radio menu. The “Coming Home” and/or “Leaving Home” delay time may also be set (default: 30 sec).

Vehicle with halogen headlights


In the “Coming Home” function, the daytime running lights (DRL), the rear side lights and the licence plate lights are turned on.

Vehicle with full-LED headlights

In the “Coming Home” function, the dipped beams, the daytime running lights (DRL), the rear side lights and the registration plate lights switch on (“Welcome Light”).

Automatic* activation of “Coming Home”

For vehicles with a light and rain sensor (rotary light switch in position **AUTO**).

- Switch off the engine and remove the key from the ignition with the rotary light switch in position **AUTO** \ggg  page 23.
- The automatic “Coming Home” function is only active when the light sensor detects darkness.
- When the car door is opened, the “Coming Home” lighting comes on.

Manual “Coming Home” activation


For vehicles with a light and rain sensor (rotary light switch without position **AUTO**).

- Switch off the engine and remove the key from the ignition.
- Activate the headlight flashers for approximately 1 second.
- Activated for any position **AUTO** of the rotary light switch.

¹⁾ This function is not available on vehicles equipped with full-LED headlights.

- When the car door is opened, the “Coming Home” lighting comes on. The headlights are turned off 60 seconds after the vehicle door is opened.

Deactivation

- If no door has been closed, they go out automatically after 60 seconds.
- After the last door has been closed, the headlights will be switched off after the “Coming Home” delay (as established in the radio menu) has elapsed.
- On turning the light switch to position 0 »»  page 23.
- When the ignition is switched on (when starting the engine).

Function “Leaving Home”

The “Leaving Home” function is only available for vehicles with a light and rain sensor (rotary light switch in position **AUTO**).

This function may be connected/disconnected through the radio menu. The “Leaving Home” function switch-off delay may also be set (default: 30 sec).

Vehicle with halogen headlights

In the “Leaving Home” function, the daytime running lights (DRL), the rear side lights and the licence plate lights are switched on.

Vehicle with full-LED headlights

In the “Leaving Home” function, the dipped beams, the daytime running lights (DRL), the rear side lights and the registration plate lights switch on (“Welcome Light”).

Activation

- When the vehicle is unlocked using the remote control.
- The “Leaving Home” function is only activated when the rotary light switch is in position **AUTO** and the light sensor detects darkness.

Deactivation

- When the “Leaving Home” delay period ends (default: 30 sec).
- When the vehicle is locked using the remote control.
- When the light control is switched into a position other than **AUTO**.
- With the ignition is switched on.

Hazard warning lights

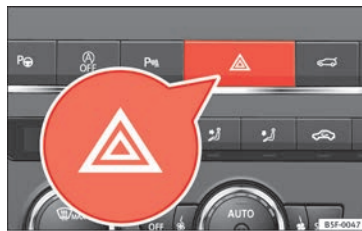



Fig. 135 Dash panel: switch for hazard warning lights.

Read the additional information carefully

»»  page 24

The hazard warning lights are used to draw the attention of other road users to your vehicle in emergencies.

If your vehicle breaks down:

1. Park your vehicle at a safe distance from moving traffic.
2. Press the button to switch on the hazard warning lights »» .
3. Switch the ignition off.
4. Apply the handbrake.
5. For a manual gearbox, engage 1st gear; for an automatic gearbox, move the gear lever to **P**.

»»

- Use the warning triangle to draw the attention of other road users to your vehicle.
- Always take the vehicle key with you when you leave the vehicle.

All turn signals flash simultaneously when the hazard warning lights are switched on. The two turn signal turn signal lamps \Leftrightarrow and the turn signal lamp in the switch \triangle will flash at the same time. The simultaneous hazard warning lights also work when the ignition is switched off.

Emergency braking warning

If the vehicle brakes suddenly and continuously at a speed of more than 80 km/h (50 mph), the brake light flashes several times per second to warn the vehicles driving behind. If you continue braking, the hazard warning lights will come on automatically when the vehicle comes to a standstill. They switch off automatically when the vehicle starts to move again.

WARNING

- The risk of an accident increases if your vehicle breaks down. Always use the hazard warning lights and a warning triangle to draw the attention of other road users to your stationary vehicle.
- Due to the high temperatures that the catalytic converter can reach, never park in an area where the catalytic converter could come

into contact with highly inflammable materials, for example dry grass or spilt petrol. This could start a fire.

Note

- The battery will run down if the hazard warning lights are left on for a long time, even if the ignition is switched off.
- The use of the hazard warning lights described here is subject to the relevant statutory requirements.

Parking lights $\text{P} \Leftarrow$

When the parking light is switched on, (right or left turn signal), the front side light and the rear light on the corresponding side of the vehicle stay lit. The parking lights can only be activated with the ignition switched off and the turn signal and main beam lever in the central position, before being triggered.

Parking light on both sides

With the ignition switched off and the light switch in position $\text{P} \Leftarrow$, when locking the vehicle from the outside, the parking lights on both sides of the vehicle light up. In doing so, only the side lights of both headlights light up, and additionally the tail lights will do so partially.

Motorway light*

The motorway light is available on vehicles equipped with full-LED lights.

The function is connected/disconnected via the corresponding Easy Connect system menu.

- Activation:** when going above 110 km/h (68 mph) for more than 30 seconds, the dipped beam raises slightly to increase the driver's visibility distance.
- Deactivation:** when reducing the speed of the car below 100 km/h (62 mph), the dipped beam returns to its normal position.

Driving abroad

The light beam of the dipped beam lights is asymmetric: the side of the road on which you are driving is lit more intensely.

When a car that is manufactured in a country that drives on the right travels to a country that drives on the left (or vice versa), it is normally necessary to cover part of the headlight bulbs with stickers or to change the adjustment of the headlights to avoid dazzling other drivers.

In such cases, the regulations specify certain light values that must be complied with for designated points of the light distribution. This is known as "Tourist light".

The light distribution of the halogen and full-LED headlights allows the specific “tourist light” values to be met without the need for stickers or changes in the settings.

Note

“Tourist light” is only allowed temporarily. If you are planning a long stay in a country that drives on the other side, you should take the vehicle to an Authorised Technical Service to change the headlights.

Headlight range control, lighting of the instrument and control panel



Fig. 136 Next to the steering wheel: Headlight range control

Lighting of the instrument panel, screens and controls*

Depending on the model, lighting of the instrument panel and controls can be adjusted

in the Easy Connect system, using the button **CAR** and the function button **SETUP** » page 26.

Headlight range control

The headlight range control » **Fig. 136** is modified according to the value of the headlight beam and the vehicle load status. This offers the driver optimum visibility and the headlights do not dazzle oncoming drivers » .

The headlights can only be adjusted when the dipped beam is switched on.

To reset, turn switch » **Fig. 136**:

Value	Vehicle load status ^{a)}
–	Two front occupants, luggage compartment empty
1	All seats occupied, luggage compartment empty
2	All seats occupied, luggage compartment full With trailer and minimum drawbar load
3	Driver only, luggage compartment full With trailer and maximum drawbar load

^{a)} If the vehicle load does not correspond to those shown in the table, it is possible to select intermediary positions.

Dynamic headlight range control

The control is not mounted in vehicles with dynamic headlight range control. The head-

light range is automatically adjusted according to the vehicle load status when they are switched on.

Instrument panel lighting

With the ignition on and without light activation, the instrument panel lighting remains activated in daytime light conditions. The lighting is reduced as the exterior light diminishes. In some cases, e.g. when driving through a tunnel without the **AUTO** function active, the instrument panel lighting may even switch off. The objective of this function is to provide the driver with a visual indication that he or she should activate the dipped beam.

WARNING

Heavy objects in the vehicle may mean that the headlights dazzle and distract other drivers. This could result in a serious accident.

- Adjust the light beam to the vehicle load status so that it does not blind other drivers.

Interior and reading lights¹⁾


»» table on page 2

Read the additional information carefully
»»  page 24

Glove compartment and luggage compartment lighting*


When opening and closing the glove compartment on the front passenger side and the rear lid, the respective light will automatically switch on and off.

Footwell lighting*

The lights in the footwell area below the dash (driver and front passenger sides) will switch on when the doors are opened and will decrease in intensity while driving. The intensity of these lights can be adjusted using the radio menu (see **Easy Connect > Light Settings > Interior lighting** »»  page 26).

Ambient light*

The ambient lighting in the door panels may change colour. The intensity of these lights can be adjusted using the radio menu (see

Easy Connect > Light Settings > Interior Lighting »»  page 26).

Note

The reading lights switch off when the vehicle is locked using a key or after several minutes if the key is removed from the ignition. This prevents the battery from discharging.

Visibility

Sun visors

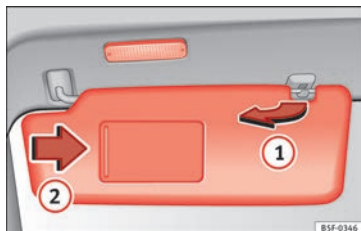


Fig. 137 Sun visor

Options for adjusting driver and front passenger sun visors:

- Lower the sun visor towards the windscreen.
- The sun visor can be pulled out of its mounting and turned towards the door »» Fig. 137 ①.
- Swing the sun visor towards the door, longitudinally backwards.

Vanity mirror light

There may be a vanity mirror, with a cover, on the rear of the sun visor. When the cover is opened ② a light comes on.

The lamp goes out when the vanity mirror cover is closed or the sun visor is pushed back up.

⚠ WARNING

Folded sun blinds can reduce visibility.

- Always store sun blinds and visors in their housing when not in use.


¹⁾ Depending on the level of equipment fitted in the vehicle, LEDs can be used for the following interior lights: front courtesy light, rear courtesy light, footwell light and sun visor light.

Note

The light above the sun visor automatically switches off after a few minutes in certain conditions. This prevents the battery from discharging.

Windscreen wiper and window wiper systems

Window wiper lever


Read the additional information carefully
»  page 25

CAUTION

If the ignition is switched off with the windscreen wipers active, they complete their wipe before returning to the rest position. When switching the ignition back on, the windscreen wiper will continue to operate at the same wiping level. Ice, snow and other obstacles on the windscreen may damage the wiper and the windscreen wiper motor.

- If necessary, remove snow and ice from the windscreen wipers before starting your journey.
- Carefully lift the frozen windscreen wipers from the glass. SEAT recommends a de-icer spray for this operation.
- Do not switch on the windscreen wipers if the windscreen is dry. Cleaning with the

windscreen wipers while dry can cause damage.

- In icy conditions, always check that the wiper blades are not frozen to the glass before using the wipers. In cold weather, it may help to leave the vehicle parked with the wipers in service position »  page 60.

Note

- The windscreen and window wipers only function when the ignition is switched on and the bonnet or rear lid, respectively, are closed.
- The interval wipe speed varies according to the vehicle speed. The faster the vehicle is moving, the more often the windscreen is cleaned.
- The rear wiper is automatically switched on when the windscreen wiper is on and the car is in reverse gear.

Windscreen wiper functions

Windscreen wiper performance in different situations

If the vehicle is at a standstill The activated position provisionally changes to the previous position.

Windscreen wiper performance in different situations

During automatic wipe

The air conditioner comes on for approximately 30 seconds in air recirculation mode to prevent the smell of the windscreen washer fluid entering the inside the vehicle.

For the interval wipe

Intervals between wipes depend on the vehicle's speed. The higher the vehicle speed the shorter the intervals.

Heated windscreen washer jets

The heating only thaws the frozen jets, it does not thaw the water in the washer hoses. When the ignition is switched on the heated windscreen washer jets automatically adjust the heat depending on the ambient temperature.

Headlight wash/wipe system

The headlight washers/wipers clean the headlight lenses.

After the ignition is switched on, the first and every fifth time the windscreen washer is switched on, the headlights are also washed. Therefore, the windscreen wiper lever should be pulled towards the steering wheel when the dipped beam or main beam are on. Any incrusted dirt (such as insects) should be cleaned regularly (e.g. when refuelling).



To ensure the headlight washers work correctly in winter, any snow which has got into the bumper jet supports should be cleaned away. If necessary, remove snow with an anti-icing spray.

Note

The wiper will try to wipe away any obstacles that are on the windscreen. The wiper will stop moving if the obstacle blocks its path. Remove the obstacle and switch the wiper back on again.

Rain sensor*

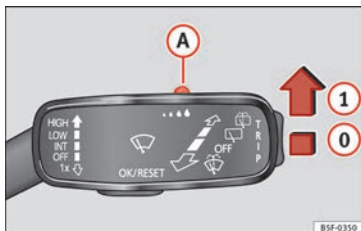


Fig. 138 Windscreen wiper lever: adjusting the rain sensor (A)

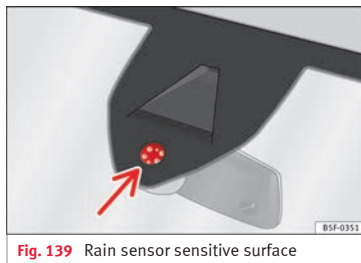


Fig. 139 Rain sensor sensitive surface

The rain sensor controls the frequency of the windscreen wiper intervals, depending on the amount of rain » **△**. The sensitivity of the rain sensor can be adjusted manually. Manual wipe » **page 139**.

Move the lever to the required position

» **Fig. 138**:

- Rain sensor off.
- ① Rain sensor on; automatic wipe if necessary.
- Ⓐ Setting sensitivity level of rain sensor
 - Set control to the right: highly sensitive.
 - Set control to the left: less sensitive.

When the ignition is switched off and then back on, the rain sensor stays on and starts operating again when the windscreen wipers are in position ① and the vehicle is travelling at more than 16 km/h (10 mph).

Rain sensor modified behaviour

Possible causes of faults and mistaken readings on the sensitive surface » **Fig. 139** of the rain sensor include:

- Damaged blades: a film of water on the damaged blades may lengthen the activation time, reduce the washing intervals or result in a fast and continuous wipe.
- Insects: insects on the sensor may trigger the windscreen wiper.
- Salt on roads: in winter, salt spread in the roads may cause an extra long wipe when the windscreen is almost dry.
- Dirt: dry dust, wax, coating on glass (Lotus effect) or traces of detergent (car wash) may reduce the effectiveness of the rain sensor or make it react more slowly, later or not at all.
- Cracked windscreen: the impact of a stone will trigger a single wipe cycle with the rain sensor on. Next the rain sensor detects the reduction in the sensitive surface area and adapts accordingly. The behaviour of the sensor will vary with the size of the damage caused by the stone.

WARNING

The rain sensor may not detect enough rain to switch on the wipers.

- If necessary, switch on the wipers manually when water on the windscreen obstructs visibility.

Note

- Clean the sensitive surface of the rain sensor regularly and check the blades for damage » Fig. 139 (arrow).
- To remove wax and coatings, we recommend a window cleaner containing alcohol.

Mirror**Anti-dazzle rear view mirror**

It is dangerous to drive if you cannot see clearly through the rear window.

Rear view mirror with automatic anti-dazzle function*

The anti-dazzle function is activated every time the ignition is switched on.

When the anti-dazzle function is enabled, the interior rear vision mirror will darken **automatically** according to the amount of light it receives. The anti-dazzle function is cancelled if reverse gear is engaged.

WARNING

In the event that an automatic anti-dazzle rear vision mirror breaks, an electrolyte fluid

may leak. This could cause irritation to the skin, eyes and respiratory organs. If you come into contact with this liquid, it must be rinsed with large quantities of water. If necessary, get medical help.

CAUTION

In the event that an automatic anti-dazzle rear vision mirror breaks, an electrolyte fluid may leak. This liquid attacks plastic surfaces. Clean it with a wet sponge as soon as possible.

Note

- If the light incident in the interior rear vision mirror is obstructed (e.g. with the sun blind*), the anti-dazzle rear vision mirror with automatic setting will not operate perfectly.
- When the interior lights are on or reverse gear engaged, the mirrors do not darken with automatic adjustment for anti-dazzle position.

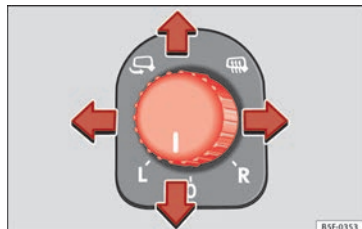
Adjusting the exterior rear view mirrors

Fig. 140 Driver door: control for the exterior mirror.

Read the additional information carefully » page 14

Synchronized regulation of the exterior mirrors

- In the **Settings - Convenience** menu, select whether or not the exterior mirrors should move in synchronisation.
- Turn the knob to position **L**¹⁾.
- Adjust the left-hand exterior mirror. The right exterior mirror will be adjusted at the same time (synchronised).

¹⁾ Regulation in right-hand drive vehicles is symmetrical.

- If necessary the right exterior mirror adjustment may need correcting. turn the control to position **R**¹⁾.
- In the Easy Connect system the exterior mirrors can be adjusted using the **CAR** button and the function button **SETUP**.

Tilt function for front passenger exterior mirror*

When parking backwards, and in order to be able to see the kerb, the passenger side mirror can be automatically tilted towards the passenger to provide a better view of the kerb. The control must be in the position **R**¹⁾ for this feature to be operational.

The mirror returns to its original position as soon as you drive forward at over 15 km/h (9 mph) or switch off the ignition. It also returns to its original position if the position of the control is adjusted.

Storing the rear view mirror settings for the tilt function

- Switch the ignition on.
- Access the Easy Connect system, Menu **CAR**, function “Rear view mirrors and windscreen wipers” and select “lower while reversing” »» page 108.

- Select the **R**¹⁾ position on the control.
- Select reverse gear.
- Adjust the front passenger exterior mirror so that you can see, for example, the kerb area well.
- Release the reverse gear.
- The adjusted position for the rear view mirror is stored.

Fold in the exterior mirrors after parking (convenience function)*

The Easy Connect system, Menu **CAR**, function “Rear view mirrors and windscreen wipers” can be used to have the exterior mirrors fold in when the vehicle is parked »» page 108.

When the vehicle is locked with the remote control, by pressing for more than approximately 1 second the exterior mirrors are folded in automatically. When the vehicle is opened with the remote control, the exterior mirrors are deployed automatically.

WARNING

Convex or wide-angle* exterior mirrors give a larger field of vision. However, they make objects look smaller and further away than they really are. If you use these mirrors to esti-

mate the distance to vehicles behind you when changing lane, you could misjudge the distance. Risk of accident!

CAUTION

- If one of the mirror housings is knocked out of position (e.g. when parking), the mirrors must first be fully retracted with the electric control. Do not readjust the mirror housing by hand, as this will interfere with the mirror adjuster function.
- Before washing the vehicle in an automatic car wash, please make sure to retract the exterior mirrors to prevent them from being damaged. Electrically retractable exterior mirrors must not be folded in or out by hand. Always use the electrical power control.

Note


If the electrical adjustment should fail to operate, both of the mirrors can be adjusted by hand by lightly pressing the edge of the mirror glass.

¹⁾ Regulation in right-hand drive vehicles is symmetrical.

Seats and head restraints

Adjusting the seats and headrests

Manual adjustment of seats

Read the additional information carefully
»»  page 12


WARNING

The safe driving chapter contains important information, tips, suggestions and warnings that you should read and observe for your own safety and the safety of your passengers
»» page 62.

WARNING

- Adjust the front seats only when the vehicle is stationary. Failure to follow this instruction could result in an accident.
- Be careful when adjusting the seat height. Careless or uncontrolled adjustment can cause injuries.
- The front seat backrests must not be reclined for driving. Otherwise, seat belts and the airbag system might not protect as they should, with the subsequent danger of injury.

Electric driver's seat adjustment*

Read the additional information carefully
»»  page 13

WARNING

- If the electric front seats are used negligently or without paying due attention, it can cause serious injury.
- The front seats can also be electrically adjusted when the ignition is switched off. Never leave a child or any other person who may need help in the vehicle.
- In the event of an emergency, electrical adjustment can be stopped by pressing any control.


CAUTION


To avoid damaging the electrical components of the front seats, please refrain from kneeling on the seat or applying sharp pressure at a single point to the seat cushion and backrest.

Note

- It may not be possible to electrically adjust the seat if the vehicle battery is very low.
- If the engine is started while the seats are being electrically adjusted, the adjustment will stop.

Adjusting the front head restraints

Read the additional information carefully
»»  page 13

Adjust the head restraint »»  page 13 so that as far as possible the top of the head restraint is level with the top of your head. When this is not possible, try to get as close as possible to this position.

Adjusting the rear head restraints

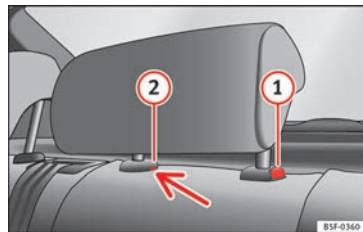



Fig. 141 Rear centre head restraint: release point.

When transporting people in the back seat, place the head restraints of the occupied seats at a minimum of the next socket up
»» .

Adjusting the head restraints

- To set the head restraint higher, grasp the sides with both hands and move it upwards, until you see it engage.
- To set the head restraint lower down, press the ① »» Fig. 141 button and move it downwards.

Removing the head restraint

To remove the head restraint, the corresponding backrest must be partially folded forward.

- Unlock the backrest »» page 146.
- Move the head restraint upwards until it arrives to the top.
- Press button ① »» Fig. 141, while simultaneously pressing on the security hole ② »» Fig. 141 with a flat screwdriver a maximum of 5 mm wide, and remove the head restraint.
- Move the backrest until it engages properly »» ⚠.

Fitting the head restraint

To mount the external head restraints, the corresponding backrest must be partially folded forward.

- Unlock the backrest »» page 146.
- Insert the head restraint bars into the guides until they perceptibly engage. It

should not be possible to remove the head restraint from the backrest.

- Move the backrest until it engages properly »» ⚠.

⚠ WARNING

- Please observe the general notes »» page 66.
- Remove the rear head restraints only when it is necessary for the placement of a child seat »» page 79. After removing a child seat, remount the head restraint immediately. Travelling with the head restraints removed or improperly adjusted increases the risk of severe injuries.

Seat functions

Introduction

⚠ WARNING

Inappropriate use of the seat functions can cause severe injuries.

- Assume the proper sitting position before your trip and remain in it throughout. This also applies to the other occupants.
- Always keep hands, fingers, feet and other parts of the body away from the operating radius and the adjustment of seats.

Seat heating

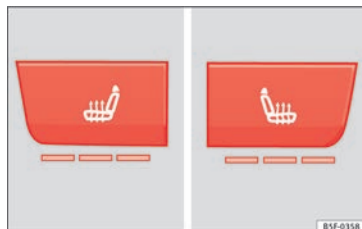




Fig. 142 In the centre console: front seats heating switch

The seat cushions can be heated electrically when the ignition is switched on. The backrest is also heated in some versions.


The seat heating should not be engaged in any of the following conditions:

- The seat is unoccupied.
- The seat has a covering.
- There is a child seat installed in the seat.
- The seat cushion is wet or damp.
- The indoor or outdoor temperature is greater than 25°C (77°F).



Activate

Press the button  or . Seat heating is switched on fully.

Adjusting the heating output

Press the button  or  repeatedly until the desired intensity level is reached.

Deactivating

Press the button  or  until all warning lamps switch off.

WARNING

Children and people who cannot perceive pain or temperature because of medications, paralysis or chronic diseases (e.g. diabetes) or have a limited perception of these, may suffer burns to the back, buttocks or legs when using seat heating, an occurrence that may entail a very lengthy recovery period or from which it may not be possible to recover fully. Seek medical advice if you have doubts regarding your health.

- People with limited pain and temperature thresholds must never use seat heating.
- If an abnormality in the device's temperature control is detected, have it checked by a specialist workshop.

WARNING

If the fabric of the cushion is wet, this can adversely affect the operation of the seat heating, increasing the risk of burns.

- Make sure the seat cushion is dry prior to using the seat heater.

- Do not sit on the seat with clothing that is wet or damp.
- Do not leave clothing that is wet or damp on the seat.
- Do not spill liquid on the seat.

CAUTION

- To avoid damaging the heating elements of the seat heaters, please do not kneel on the seat or apply sharp pressure to a single point on the seat cushion or backrest.
- Liquids, sharps objects and insulating materials (e.g. covers or child seats) can damage the seat heating.
- In the event of smells, switch off the seat heating immediately and have it inspected by a specialised workshop.

For the sake of the environment

The seat heating should remain on only when needed. Otherwise, it is an unnecessary fuel waste.

Front centre armrest

The centre armrest can be adjusted to various levels.

Adjusting the centre armrest

- To adjust the tilt, lift the armrest from the starting position so that it is engaged.

- To return the armrest to the starting position, remove the armrest from the upper fixed position and lower it.

The armrest can be moved backwards and forwards.

Folding down and lifting the rear seat backrest

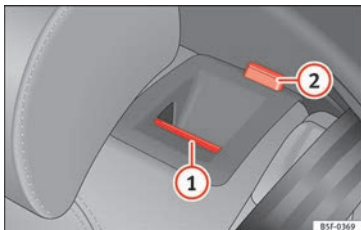


Fig. 143 On the rear seat backrest: release catch (1); red mark (2).

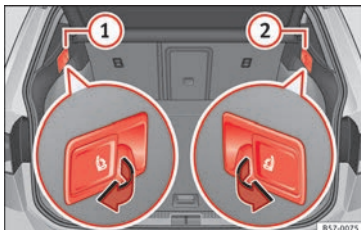


Fig. 144 In the luggage compartment: levers for remote release of the left part (1) and right part (2) of the rear seat backrest.

The rear seat backrest is split and each part can be lowered separately to extend the luggage compartment.

When the rear seat backrest is lowered nobody else can travel in the corresponding seats (not even a child).

Lowering the rear seat backrest with the unlock button

- Lower the head restraint properly.
- Push the unlock button » Fig. 143 (1) forwards and at the same time lift the backrest.
- The rear seat backrest is not engaged when the red marking of the button (2) is visible.

Lowering the rear seat backrest with the remote release lever

- Lower the head restraint properly.
- Open the rear lid.
- Pull the remote release lever of the left part » Fig. 144 (1) or right part (2) of the backrest in the direction of the arrow. The released part of the rear seat backrest is folded automatically down and forwards.
- If this occurs, close the rear lid.

The rear seat backrest is not engaged when the red marking of the button » Fig. 143 (2) is visible.

Folding up the rear seat backrest

- Lift the backrest and press it firmly into the lock until it engages » △.

- It should not be possible to see the red mark of the unlock button (2).
- The backrest must be properly engaged.

⚠ WARNING

Serious injuries can be caused if the rear seat backrest is lowered or lifted without due care and attention.

- Never lower or lift the rear seat backrest while driving.
- Do not trap or damage the seat belt when raising the rear seat backrest.
- When lowering or lifting the rear seat backrest, keep your hands, fingers, feet and other body parts out of its path.
- For the rear seat belts to offer the necessary protection all the parts of the rear backrest must be properly engaged. This is particularly important in the case of the centre rear seat. If someone is seated in a seat whose backrest is not properly engaged they will fly forward, along with the backrest, during an accident or a sudden driving or braking manoeuvre.
- A red signal on the button (2) warns that the backrest is not engaged. Always check that the red marking is not visible when the backrest is in the upright position.
- When the rear seat backrest is lowered or is not properly engaged nobody else can travel in the corresponding seats (not even a child).

ⓘ CAUTION

Serious damage can be caused to the vehicle and other objects if the rear seat backrest is lowered or lifted without due care and attention.

- Before lowering the rear seat backrest, always adjust the front seats so that neither the head restraints nor the cushions of the rear backrest can hit them.

Transport and practical equipment

Storage compartments

Storage areas under the front seats*



Fig. 145 Storage compartment under the front seats.

There is a storage compartment with a cover under each front seat.

The drawer* is opened by pulling on the handle of the cover » **Fig. 145**.

To close the drawer, press the cover until it locks into position.

⚠ WARNING

- The drawers will hold a maximum weight of 1.5 kg.

- Do not drive with the drawer cover open. There is an injury risk for passengers if the cargo is released in case of sudden braking or an accident.

Drink holders



Fig. 146 Centre console: front drink holders.

Front drink holders

- Place drinks in the holder » **Fig. 146**. Placement of two drinks is possible. There is also the possibility of placing larger plastic bottles in the trims of the doors.

⚠ WARNING

- Do not place any hot drinks in the drink holder while the vehicle is moving. Hot drinks could spill and cause burns, which may cause an accident.

- Do not use hard china cups or glasses. These could cause injury in the event of an accident.

ⓘ CAUTION

You should avoid putting open drinks containers in the drink holders. The drinks could otherwise spill over and cause damage to e.g. the electrical equipment or the seat covers.

Glove compartment



Fig. 147 Glove compartment

Opening/closing

- To open the glove compartment, pull the handle in the direction of the arrow.
- To close the glove compartment, move the cover upwards until it engages.

Depending on the vehicle equipment, the CD player is located in the glove compartment. Separate operating instructions are enclosed for this equipment in the corresponding Instruction Manual.

⚠ WARNING

The cover of the glove compartment should always be closed while driving. Failure to follow this instruction could result in an accident.

Other storage compartments

You will find more object holders, compartments and supports in other parts of the vehicle:

- In the top of the glove compartment in vehicles that do not have a CD reader. The load of the compartment should not exceed 1.2 kg.
- In the centre console under the centre armrest*.
- Coat hooks in the door frames »» ⚠.
- Other storage compartments are found in the rear seat, to the left and the right of the seats.

⚠ WARNING

- Please make sure that any items of clothing hanging from the coat hooks do not obstruct your view to the rear.
- The coat hooks should only be used for lightweight clothing. Do not leave any heavy or sharp objects in the pockets.
- Do not use clothes hangers to hang up the clothing, as this could interfere with the function of the head-protection airbags.

Socket



Fig. 148 Centre console: 12 volt socket

- Remove the cap located on the centre console of the socket »» Fig. 148.
- Insert the plug of the electrical appliance into the power socket.

Electrical equipment can be connected to the 12 volt power socket. The appliances connected to each power socket must not exceed a power rating of 120 Watt.

WARNING

The power socket works only when the ignition is on. Improper use may cause serious injury or even fire. Children should therefore not be left in the vehicle unattended if the button is also left behind. Otherwise there is a possibility that they may be injured.

CAUTION

Always use the correct type of plugs to avoid damaging the sockets.

Note

The use of electrical appliances with the engine switched off will cause a battery discharge.

Storing objects

Loading the luggage compartment

All luggage and other loose objects must be safely secured in the luggage compartment. Unsecured objects which shift back and forth could impair the driving safety or driving

characteristics of the vehicle by shifting the centre of gravity.

- Distribute the load evenly in the luggage compartment.
- Place heavy objects as far forward as possible in the luggage compartment.
- Place the heavy objects first.
- Secure heavy objects to the fitted fastening rings »» page 151.

WARNING

- Loose luggage and other objects in the luggage compartment could cause serious injuries.
- Always stow objects in the luggage compartment and secure them on the fastening rings.
- Use suitable straps to secure heavy objects.
- During sudden manoeuvres or accidents, loose objects can be thrown forward, injuring vehicle occupants or passers-by. This increased risk of injury will be further increased if a loose object is struck by an inflating airbag. If this happens, objects may shoot outward like a missile. Risk of fatal injury.
- Please note that the centre of gravity may shift when transporting heavy objects; this may affect vehicle handling and lead to an accident. Therefore, it is essential to adjust your speed and driving style accordingly, to avoid accidents.

- Never exceed the allowed axle weights or allowed maximum weight. If said weights are exceeded, the driving characteristics of the vehicle may change, leading to accidents, injuries and damage to the vehicle.
- Never leave your vehicle unattended, especially when the rear lid is open. Children could climb into the luggage compartment, closing the door behind them; they will be trapped and run the risk of death.
- Never allow children to play in or around the vehicle. Close and lock all the doors and rear lid when you leave the vehicle. Before you lock the vehicle, make sure that there are no adults or children in the vehicle.

Note

- Air circulation in the vehicle helps reduce fogging of the windows. Used air escapes through ventilation slits in the side trim of the luggage compartment. Ensure that the ventilation slots are never covered.
- Straps for securing the load to the fastening rings are commercially available.

Luggage compartment cover

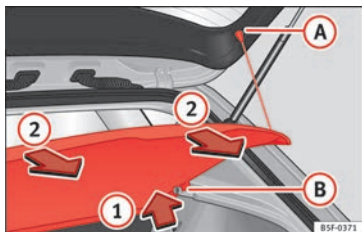


Fig. 149 Rear lid open with the luggage compartment cover.

The luggage compartment cover blocks the view into the luggage compartment.

Removing

- Remove the straps **A** and unfasten the cover of the support **B** by pressing upwards in the direction of arrow **1**.

Fitting

- Insert the cover horizontally so that it coincides with the “plate” on the axis of the supports **B** and press down until it engages.
- Attach the straps to the rear lid **A** » » **△**.

△ WARNING

- The luggage compartment cover must always be fixed properly (risk of accident).
- The luggage compartment cover should not be used as a storage shelf. Articles placed on this cover could cause injury to vehicle occupants in an accident or if the brakes are applied suddenly.

Storing the rear shelf

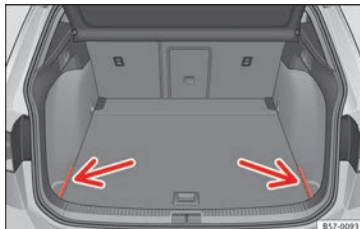


Fig. 150 In the luggage compartment: covers for storing the rear shelf.



Fig. 151 In the luggage compartment: fitting the storage compartment shelf.

The rear shelf can be stored under the luggage compartment variable floor.

- Remove the left and right covers » » **Fig. 150**.
- Press the rear shelf until it engages in its housing » » **Fig. 151**.
- Put the left and right covers in their original position.

Tailboard for transporting long items*


Fig. 152 On the rear seat backrest: opening the tailboard.

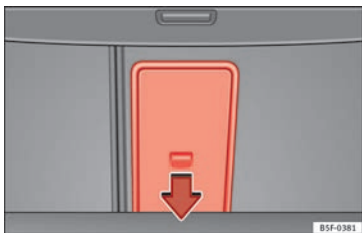


Fig. 153 In the luggage compartment: opening the tailboard.

On the rear seat, behind the central armrest, there is a tailboard for transporting long items in the interior, such as skis.

To avoid soiling the interior, dirty objects should be wrapped (e.g. in a blanket) before they are inserted through the tailboard.

When the armrest is down, nobody may travel in the centre rear seat.

Opening the tailboard

- Lower the centre armrest.
- Pull the release lever in the direction of the arrow and push the tailboard cover
- » **Fig. 152** ① down and forwards.
- Open the rear lid.
- Insert the long objects through the gap from the luggage compartment.
- Secure the objects with the seatbelt.
- Close the rear lid.

Closing the tailboard

- Lift the tailboard cover until it engages. The red mark on the luggage compartment side should never be visible.
- Close the rear lid.
- Lift the centre armrest if necessary.

Note

The tailboard can also be opened from the luggage compartment. To do so, press the release lever down, in the direction of the arrow, and the cover upwards » **Fig. 153**.

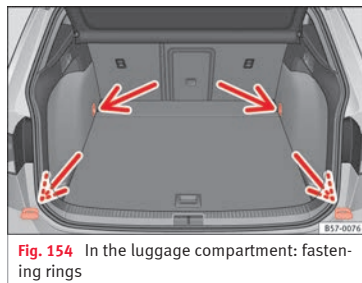
Fastening rings*


Fig. 154 In the luggage compartment: fastening rings

In the front and rear part of the luggage compartment there are fastening rings to secure the luggage » **Fig. 154**.

In order to use the front fastening rings, they must be lifted beforehand.

⚠ WARNING

If unsuitable or damaged belts or retaining straps are used, they could break in the event of braking or an accident. Objects could then be launched across the passenger compartment and cause serious or fatal injuries.

- Always use belts or retaining straps that are suitable and in a good condition.
- Belts and retaining straps should be securely fastened to the fastening rings.

- Objects in the luggage compartment that are unsecured could move suddenly and modify the handling of the vehicle.
- Secure all objects, little and large.
- Never exceed the maximum tensile load of the fastening ring when securing objects.
- Never secure a child seat to the fastening rings.

Note

- The maximum tensile load that the fastening rings can support is 3.5 kN.
- Belts and securing systems for the appropriate load can be obtained from specialised dealerships. SEAT recommends visiting a SEAT dealership for this.
- The fastening rings are rendered unusable for versions with a spare wheel.

Retaining hooks

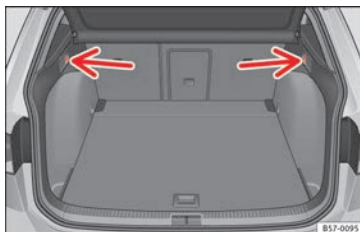


Fig. 155 In the luggage compartment: retaining hooks

At the rear of the luggage compartment, on the left and right, there are fixed retaining hooks » **Fig. 155**.

The retaining hooks have been designed to secure light shopping bags.

WARNING

Never use the retaining hooks as fastening rings. In case of sudden braking or an accident, the hooks could break.

CAUTION

Each hook is designed for a maximum load of 2.5 kg.

Net bag*

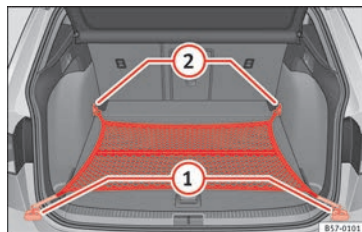


Fig. 156 In the luggage compartment: net bag hooked to the ground.

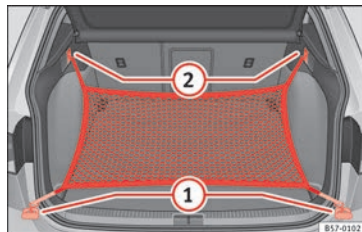


Fig. 157 In the luggage compartment: rings ① and hooks ② for attaching the net bag.

The luggage compartment prevents light luggage from moving. The net bag has a zip and can be used to store small objects.

The net bag can be hooked up to the luggage compartment in different ways.

Hooking the net bag into the luggage compartment floor

- As applicable, lift the front fastening rings » Fig. 156 ②.
- Secure the net hooks to the fastening rings ② » ⚠. The bag zip should be facing upwards.
- Secure the net hooks to the fastening rings ①.

Hook the net bag next to the load threshold

- Secure the short net hooks to the fastening rings » Fig. 157 ① » ⚠. The bag zip should be facing upwards.
- Secure the straps in the bag hooks ②.

Removing the net bag

The hooked up net bag is taut » ⚠.

- Remove the hooks and the net bag straps from the fastening rings and from the bag hooks.
- Store the net bag in the luggage compartment.

⚠ WARNING

To secure the elastic net bag on the fastening rings it must be stretched out. Once hooked up it is taut. If the net bag is hooked up or unhooked incorrectly the hooks could cause injuries.

- Always secure the net hooks properly so that they do not suddenly release from the fastening rings when hooking or unhooking them.
- On hooking or unhooking them, protect your eyes and face in case the hooks are released suddenly.
- Always hook up the net bag hooks in the described order. If a hook is unexpectedly released the risk of injury is increased.

Luggage compartment variable floor

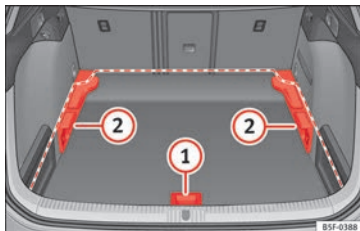


Fig. 158 Luggage compartment variable floor: positions.

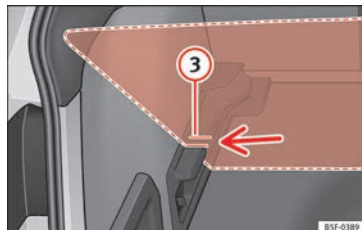


Fig. 159 Luggage compartment variable floor: grooves tilted.

Variable floor in the high position

- Lift the floor using handle » Fig. 158 ① and pull it back until the front of the floor has fully passed the supports ②.
- Move the floor forward over the supports as far as the rear seat backrest and then lower the floor with the handle ①.

Variable floor in the low position

- Lift the floor using handle » Fig. 158 ① and pull it back until the front of the floor has fully passed the supports ②.
- Now match the front part with the lower grooves of the supports and slide the floor forwards as far as the rear seat backrest and lower the floor at the same time with the handle ①.

Variable floor in the tilted position

When the variable floor is tilted you can access the spare wheel/anti-puncture kit area.

- Lift the variable floor using handle »» Fig. 158 ① and pull it back until the front of the floor has fully passed the tilted grooves »» Fig. 159 ③.
- Pass the floor through these slots using the handle ①, pushing until the movable front of the variable floor folds and rests on the floor itself.

Variable floor with folded seats

- Lift the variable floor by the handle »» Fig. 158 ① and pull it back a little.
- Push the variable floor towards the folded rear seats with the handle ① using some downward pressure so that the moving part of the floor is flush with the backs of the rear seats.

WARNING

During a sudden driving or braking manoeuvre, or in the event of an accident, objects could be flung through the interior and cause serious or fatal injuries.

- Always secure objects, even when the luggage compartment floor is properly lifted.
- Only objects that do not protrude more than 2/3 the height of the floor may be car-

ried between the rear seat and the raised luggage compartment floor.

- Only objects that do not weigh than approximately 7.5 kg may be carried between the rear seat and the raised luggage compartment floor.

CAUTION

- The maximum weight that can be loaded on the luggage compartment variable floor in the top position is 150 kg.
- Do not let the luggage compartment floor fall when closing it. Always carefully guide it downwards in a controlled manner. Otherwise, the lining and the floor of the luggage compartment could be damaged.

Note

SEAT recommends the use of straps to secure objects to retaining rings.

Roof carrier

Introduction

The vehicle roof has been designed to optimise aerodynamics. For this reason, cross bars or conventional roof carrier systems cannot be secured to the roof water drains.

As the roof water drains are integrated in the roof to reduce air resistance, only SEAT-approved cross bars and roof carrier systems can be used.

Cases in which cross bars and the roof carrier system should be disassembled.

- When they are not used.
- When the vehicle is washed in a car wash.
- When the vehicle height exceeds the maximum height, for example, in some garages.

WARNING

When heavy or bulky loads are transported on the roof carrier system, car driving performance is affected, as the centre of gravity shifts and there is greater wind resistance.

- Always secure the load properly using belts or retaining straps that are suitable and in a good condition.
- Bulky, heavy, long or flat loads have a negative effect on aerodynamics, the centre of gravity and driving performance.
- Avoid sudden braking and manoeuvres.
- Adapt your speed and driving style at all times to suit visibility, weather, road and traffic conditions.

CAUTION

- Remove the cross bars and the roof carrier system before entering a car wash.

- Vehicle height is increased by the installation of cross bars or a roof carrier system and the load secured on them. For this purpose, check that your vehicle's height does not surpass the headspace limit, for example, for underpasses or for entering garage doors.
- Cross bars, the roof carrier system and the load secured on them should not interfere with the roof aerial or hamper the path of the panoramic sun roof and the rear lid.
- On opening the rear lid make sure that it does not knock into the roof load.

 For the sake of the environment

When cross bars and a roof carrier system are installed, the increased air resistance means that the vehicle uses more fuel.

Attach the cross bars of the roof carrier system

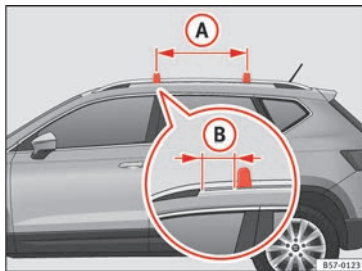


Fig. 160 Attachment points for the roof railings for the roof carrier system.

The crossbars are the basis of a series of special roof carrier systems. For safety reasons, special fixtures must be used to safely transport luggage, bicycles, skis, surf boards or boats on the roof. Suitable accessories can be acquired at SEAT dealerships.

Always secure the crossbars and the roof carrier system properly. Always take the assembly instructions that come with the crossbars and the roof carrier system in question into account.

The crossbars are assembled on the roof railings. The distance between crossbars

» **Fig. 160 A** should be between 70 and 100 cm and the distance between the cross-

bars and the brackets of the roof railings **B** must be evenly distributed.

 **WARNING**


Incorrect attachment and use of the crossbars and the roof carrier system may cause the whole system to detach from the roof and cause an accident and injuries.

- Always take the manufacturer assembly instructions into account.
- Use only crossbars and the roof carrier system when they are in perfect condition and are properly secured.
- Secure the crossbars and the roof carrier system properly.
- Check threaded joints and attachments travelling and if necessary tighten them after you have travelled a short distance. When making long trips, check the threaded joints whenever you stop for a rest.
- Always fit the special roof carrier systems correctly for wheels, skis and surfboards, etc.
- Do not modify or repair the crossbars or roof carrier system.


 **Note**

Always read the assembly instructions that come with the crossbars and the roof carrier system carefully and keep them in the vehicle.

Loading the roof carrier system

The load can only be secured if the crossbars and the roof carrier system are properly installed » .


Maximum authorised roof load

The maximum permissible roof load is **75 kg**. This figure comes from the combined weight of the roof carrier, the cross bars and the load itself on the roof » .

Always check the weight of the roof carrier system, the cross bars and the weight of the load to be transported and weigh them if necessary. Never exceed the maximum authorised roof load.

If you are using cross bars and a roof carrier with a lower weight rating, you will not be able to carry the maximum authorised roof load. In this case, do not exceed the maximum weight limit for the roof carrier which is listed in the fitting instructions.

Distributing a load

Distribute loads uniformly and secure them correctly » .

Check attachments

Once the cross bars and roof carrier system have been installed, check the bolted connections and attachments after a short jour-

ney and subsequently with a certain frequency.

WARNING

Exceeding the maximum authorised roof load can result in accidents and considerable vehicle damage.

- Never exceed the maximum authorised load on the roof and on the axles or the vehicle's maximum authorised weight.
- Never exceed the load capacity of the cross bars and the roof carrier system, even if the maximum authorised roof load has not been reached.
- Secure heavy items as far forward as possible and distribute the vehicle load uniformly.

WARNING


If the load is loose or not secured, it could fall from the roof carrier system or cause accidents and injuries.

- Always use belts or retaining straps that are suitable and in a good condition.
- Secure the load properly.

Air conditioning

Heating, ventilation and cooling

Introduction

Read the additional information carefully »  page 42

Viewing Climatronic information

On the screen of Climatronic control unit and on the screen of the factory-fitted Easy Connect system, the theoretical values of the temperature zones are shown.

The unit of temperature measurement can be changed in the Easy Connect system.

Dust and pollen filter

The dust and pollen filter with its activated charcoal cartridge serves as a barrier against impurities in the air taken into the vehicle interior.

The dust and pollen filter must be changed regularly so that air conditioner performance is not adversely affected.

If the filter loses efficiency prematurely due to use in areas with very high levels of air pollution, the filter must be changed more frequently than stated in the Service Schedule.

⚠ WARNING

Reduced visibility through the windows increases the risk of serious accidents.

- Always ensure that all windows are free of ice and snow, and that they are not fogged, so as to maintain good visibility of everything outside.
- The maximum heat output required to defrost windows as quickly as possible is only available when the engine has reached its normal running temperature. Only drive when you have good visibility.
- Always ensure that you use the heating system, fresh air system, air conditioner and the heated rear window to maintain good visibility to the outside.
- Never leave the air recirculation on for a long period of time. If the cooling system is switched off and air recirculation mode switched on, the windows can mist over very quickly, considerably limiting visibility.
- Switch air recirculation mode off when it is not required.

⚠ WARNING

Stuffy or used air will increase fatigue and reduce driver concentration possibly resulting in a serious accident.

- Never leave the fresh air fan turned off or use the air recirculation for long periods of time; the air in the vehicle interior will not be refreshed.

⚠ CAUTION

- To replace the pollen filter, always visit a service centre.
- Switch the air conditioner off if you think it may be broken. This will avoid additional damage. Have the air conditioner checked by a specialised workshop.
- Repairs to the air conditioner require specialist knowledge and special tools. SEAT recommends visiting a SEAT Official Service.

i Note

- When the cooling system is turned off, air coming from the outside will not be dried. To prevent fogging of the windows, SEAT recommends leaving the cooling system (compressor) turned on. To do this, press the button **(A/C)**. The button lamp should light up.
- The maximum heat output required to defrost windows as quickly as possible is only available when the engine has reached its normal running temperature.
- Keep the air intake slots in front of the windscreen free of snow, ice and leaves to ensure heating and cooling are not impaired, and to prevent the windows from misting over.

Adjust using the Easy Connect system*

✓ Applies to vehicles with a Touch/Colour Media System.

In the Easy Connect system it is also possible to perform various adjustments to the Climatronic.

Open the air conditioner menu

- Press the **(Setup)** button.
- **OR:** press the **(MENU)** button in Easy Connect. With the rotating switch select the **air conditioner** menu and open it.

On the touch screen you can see and change the current settings, for example, the temperature set for the driver and passenger sides, the air distribution and the fan speed. With button **(SYNC)** the driver and passenger side temperatures are synchronised » **Booklet Media System Touch/Colour, chapter Air conditioning.**

To switch a function on or off, or to select a submenu, you must press the corresponding function button.

For more information about functions » **page 108.**

Function button	Function
OFF	Switch off and switch on the Climatronic.
SETUP	<p>The air conditioning settings submenu is opened. It is possible to make the following adjustments:</p> <p>Function button (Air conditioning profile): to adjust the level of the fan in AUTO mode. You can choose between low, medium and high.</p> <p>Function button (Automatic air recirculation) to switch on and off automatic air recirculation » page 160.</p> <p>(BACK →) function button to close the submenu.</p>

Adjust using the Easy Connect system*

✓ Applies to vehicles with a Media System Plus/Navit System.

In the Easy Connect system it is also possible to perform various adjustments to the Climatronic.

Open the air conditioner menu

- Press the (Setup) button.

On the top of the screen you can see and change the current settings, such as, for example, the temperature set for the driver side and for that of passenger. Temperatures up

to +22°C (+72°F) are shown with blue arrows, and temperatures over +22°C (+72°F) with red arrows.

To switch a function on or off, or to select a submenu, you must press the corresponding function button.


Function button	Function
Air conditioning profile	Adjust the fan level in AUTO mode. You can choose between low, medium and high.
OFF	Climatronic is switched off.
ON	Climatronic is switched on.
SETUP	<p>The air conditioning settings submenu is opened. It is possible to make the following adjustments:</p> <p>Function button (Air conditioning profile): to adjust the level of the fan in AUTO mode. You can choose between low, medium and high.</p> <p>Function button (Automatic air recirculation) to switch on and off automatic air recirculation » page 160.</p> <p>(BACK →) function button to close the submenu.</p>
Automatic supplementary heating	Activate/deactivate the automatic activation of the supplementary heating for colder countries (only for engines with supplementary heating). With the option deactivated, depending on the outside temperature the heating may need more time than normal to reach a comfortable temperature.

Air conditioning user instructions

The interior cooling system only works when the engine is running and fan is switched on.

The air conditioner operates most effectively with the windows and the panoramic sliding sunroof closed. However, if the vehicle has heated up after standing in the sun for some time, the air inside can be cooled more quickly by opening the windows and the panoramic sliding sunroof briefly.

Climatronic: change the temperature unit on the screen of the radio or on the factory-fitted navigation system

Changing the temperature display from Celsius to Fahrenheit on radio or on the factory-fitted navigation system is done using the menu on the instrument panel »  page 29.

The cooling system cannot be activated

If the air conditioning system cannot be switched on, this may be caused by the following:

- The engine is not running.
- The fan is switched off.
- The air conditioner fuse has blown.
- The outside temperature is lower than approximately +3°C (+38°F).

- The air conditioner compressor has been temporarily switched off because the engine coolant temperature is too high.
- Another fault in the vehicle. Have the air conditioner checked by a specialised workshop.

Special Characteristics

If the humidity and temperature outside the vehicle are high, **condensation** can drip off the evaporator in the cooling system and form a pool underneath the vehicle. This is normal and does not indicate a leak!

Note

After starting the engine, any residual humidity in the air conditioner could mist over the windscreen. Switch on the defrost function as soon as possible to clear the windscreen of condensation.

Air outlets

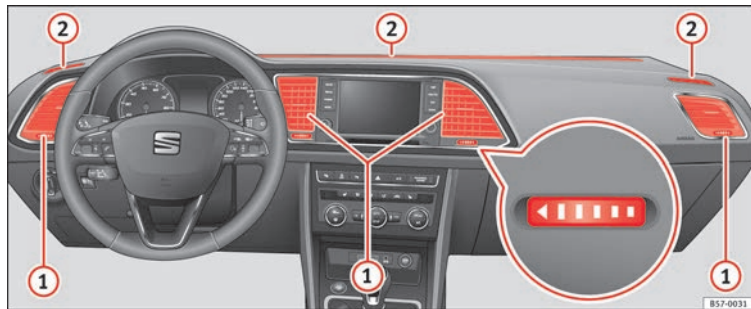


Fig. 161 On the dash panel: air vents

Air vents

To ensure proper heating, cooling and ventilation in the vehicle interior, air vents » Fig. 161 ① should remain open.

- Turn the corresponding thumbwheel (detail) in the required direction to open and close the air vents. When the thumbwheel is

in the ► position, the corresponding air vent is closed.

- Change the air direction using the ventilation grille lever.

There are other additional, non-adjustable air vents in the dash panel ②, in the footwell and in the rear area of the interior.

Note

Food, medicine and other heat or cold sensitive objects should never be placed in front of the air outlets as they may be damaged or made unsuitable for use by the air coming from the air vents.

Air recirculation mode

Basic points



Air recirculation:




Manual recirculation


Air recirculation mode prevents the ambient air from entering the interior.

When the outside temperature is very high, selecting manual air recirculation mode for a short period refreshes the vehicle interior more quickly.

For safety reasons, air recirculation mode is switched off when the button **MAX**  is pressed or the air distributor turned to .

Switching the manual air recirculation mode on and off

To switch system on: press the  button until the warning lamp lights up.

To switch system off: press the  button until the warning lamp goes off.

Functioning mode of automatic air recirculation (air conditioning menu)

With the automatic air recirculation mode activated, the entry of fresh air into the cabin interior is enabled. If the system detects a high concentration of hazardous substances in the ambient air, air recirculation mode is switched on automatically. When the level of

impurities drops to within a normal range, recirculation mode is switched off.


The system is unable to detect unpleasant smells.

The air recirculation will **not** connect automatically in versions without humidity sensor and in the following external conditions:

- The outside temperature is lower than +3°C (+38°F).
- The cooling system is switched off and the outside temperature is below +10°C (+50°F).
- The cooling system is switched off, the outside temperature is below +15°C (+59°F) and the windscreen wipers are switched on.

Activation/deactivation of automatic air recirculation is done in the air conditioner menu, under Configuration.

WARNING

Observe the safety warnings »  in Introduction on page 157.

- **If the cooling system is switched off and air recirculation mode switched on, the windows can mist over very quickly, considerably limiting visibility.**
- **Switch air recirculation mode off when it is not required.**

CAUTION

Do not smoke when air recirculation is switched on in vehicles with an air conditioner. The smoke taken in could lie on the cooling system vaporiser and on the activated charcoal cartridge of the dust and pollen filter, leading to a permanently unpleasant smell.

Note

Climatronic: air recirculation mode is activated to prevent exhaust gas or unpleasant odours from entering the vehicle interior when it is in reverse and while the automatic windscreen wiper is working.

Auxiliary heater (additional heater)

Introduction

The auxiliary heater runs on fuel from the vehicle's tank and can be used while you are driving and when the vehicle is stationary.

The auxiliary heater can be switched on using the fast heating button of the air conditioning controls, with the remote control or by previously programming a departure time in the auxiliary heater menu of the infotainment system.

In winter, with the auxiliary heater switched on, you can defog the windscreen and leave it free of ice and snow (if it is a thin layer) before you start driving.

If the outside temperature is very high, the vehicle interior can be ventilated with the engine off using the auxiliary heater.

WARNING

Swallowing a battery with a 20 mm diameter or any other button battery can cause serious and even fatal injuries within a very short time.

- Always keep the remote control, keyrings with batteries, the spare batteries, button batteries and all other batteries over 20 mm out of reach of children.

- If you suspect that someone may have swallowed a battery, seek immediate medical attention.

WARNING

The auxiliary heater exhaust fumes contain carbon monoxide, an odourless and colourless toxic gas. Carbon monoxide can cause people to lose consciousness. It can also cause death.

- Never switch on the auxiliary heater or leave it running in enclosed spaces or areas with no ventilation.
- Never programme the auxiliary heater so that it switches itself on and is running in an enclosed space or an area with no ventilation.

WARNING

The components of the auxiliary heater are extremely hot and could cause a fire.

- Always park your vehicle so that no part of the exhaust system can come in contact with easily flammable materials that might be below the vehicle, such as dried grass.

CAUTION

Never place food, medicines or other temperature-sensitive objects close to the air vents. Food, medicines and other objects sensitive to heat or cold may be damaged or made un-

suitable for use by the air coming from the vents.

Note

After switching the engine on with a 12-volt battery that is heavily discharged or newly changed or after a jump start some system settings (such as the time, the date, the personalised comfort settings and the programming) might be altered or deleted. Check and correct these settings once the battery is sufficiently charged.

Switching on and off the auxiliary heater

Switching the auxiliary heater on:



Manually with the fast heating button of the air conditioner controls. The control lamp of the button will light up » page 156.



Manually with the remote control » page 162.

Automatically by programming and activating a departure time » page 163.

Switching the auxiliary heater off:



Manually with the fast heating button of the air conditioner controls. The control lamp of the button goes off » page 156.

OFF Manually with the remote control » page 162. »

Switching the auxiliary heater off:

Automatically once the programmed departure time has arrived or after the programmed operating time has elapsed » page 163.

Automatically when the control lamp (fuel level indicator) » page 276 lights up.

Automatically when the 12-volt battery charge is too low » page 289.

Special feature

Once switched off, the auxiliary heater will continue to operate for a short period of time in order to burn the fuel remaining in the system and also to expel the exhaust fumes.

Remote control



Fig. 162 Auxiliary heater: remote control.

Fig. 162

Meaning



Switch the auxiliary heater on

OFF

Switch the auxiliary heater off



Control lamp

If the buttons of the remote control are pressed unnecessarily, it could switch on the auxiliary heater involuntarily, even when it is out of range or when the control lamp is flashing.

Control lamp on the remote control

When the buttons are pressed, the control lamp on the remote control provides the user with different information:

Control lamp ①	Meaning
It will light for about 2 seconds in green.	The auxiliary heater has been switched on using the button.
It will light for about 2 seconds in red.	The auxiliary heater has been switched off using the OFF button.
It flashes green slowly for approximately 2 seconds (approximately 4 times per second).	No on ^{a)} signal has been received.

Control lamp ①

Meaning

It flashes green quickly for approximately 2 seconds (approximately 10 times per second).

The auxiliary heater is locked.
Possible causes: The fuel tank is almost empty, the 12-volt battery charge is too low or there is a fault.

It flashes red for approximately 2 seconds (approximately 4 times per second).

No off^{a)} signal has been received.

It will light for about 2 seconds in orange, then green or red.

The remote control battery is almost flat. However, the on or off signal has been received.

It will light for about 2 seconds in orange, then it flashes green or red.

The remote control battery is almost flat. No on or off signal has been received.

It flashes orange for approximately 5 seconds.


The remote control battery is flat. No on or off signal has been received.

^{a)} The remote control is out of range. In this case it will be necessary to get closer to the vehicle and press the corresponding button again.

Replacing the remote control battery

If, when pressing the buttons of the remote control, control lamp ① flashes orange for approximately 5 seconds or it does not switch on, the remote control battery will need replacing.

The battery is located beneath a cover on the back of the remote control.

- To open the cover, lift it slightly at the bottom and slide it down.
- Remove the old battery.
- Insert the new battery. When doing so, take into account the polarity and use batteries of the same type **»** .
- Replace the battery cover by inserting the tabs at the top and pressing the bottom.

Range

The receiver is inside the vehicle. The remote control, when fitted with new batteries, has a range of several hundred metres. Obstacles between the remote control and the vehicle, bad weather conditions and discharged batteries can considerably reduce the range of the remote control.


CAUTION

- **The radio frequency remote control contains electronic components. Therefore, avoid getting it wet and exposing it to knocks or direct sunlight.**
- **The use of inappropriate batteries may damage the radio frequency remote control. For this reason, always replace the used battery with another of the same voltage, size and specifications.**

For the sake of the environment

- **Please dispose of your used batteries correctly and with respect for the environment.**
- **The remote control battery may contain perchlorate. Observe the legal provisions regarding disposal.**
- **Care should be taken so as not to operate the remote control unintentionally so as to prevent the auxiliary heater being switched on accidentally.**

Programming the auxiliary heater


Before programming it, check that the vehicle's date and time are set correctly **»** .

The auxiliary heater is programmed in the **Auxiliary heater** menu of the infotainment system.




Open the **Auxiliary heater** menu.


- Press the button **MENU** in the Climatronic control panel.
- Press the  function button.




Function button: function



: The auxiliary heater is immediately switched off.


Function button: function

 : Set to heat or ventilate the vehicle interior when the auxiliary heater is switched on. By pressing the function button , you can select the desired mode.

: Opens the **Auxiliary heater** menu.


  : Three different departure times (hh.mm) may be programmed. If the auxiliary heater should only be switched on a certain day of the week, this can also be selected.

: The duration determines the operating time of the auxiliary heater when switched on using the fast heating button  on the air conditioning controls. The duration is also used to calculate the departure time for the manual air conditioner. It can be set between 10 and 60 minutes at 10-minute intervals.

 This returns to the main menu.

The programmed departure time determines the approximate time it should take to reach the temperature set in the vehicle. The start of the heating operation is determined automatically depending on the outside temperature.

Checking the programming

When a departure time is activated and the ignition is switched off the control lamp of the fast heating button  lights up for approximately 10 seconds. **»**

⚠ WARNING

Never programme the auxiliary heater so that it switches itself on and is running in an enclosed space or an area with no ventilation. The auxiliary heater exhaust fumes contain carbon monoxide, an odourless and colourless toxic gas. Carbon monoxide can cause people to lose consciousness. It can also cause death.

Operating instructions


The auxiliary heater exhaust system located below the vehicle must be kept clear of snow, mud and other objects. The exhaust fumes must be able to exit freely. The emissions generated by the auxiliary heater are removed via an exhaust pipe fitted underneath the vehicle.

On heating the vehicle interior, depending on the outside temperature, the warm air is first directed at the windscreen and then to the rest of the vehicle interior through the air vents. Directing the diffusers – towards the windows for example – can affect air distribution.

When will the auxiliary heater not be activated?

- The auxiliary heater requires about as much power as the dipped beam headlights. If the 12-volt battery charge is too low, the

auxiliary heater switches off automatically and cannot be switched on. This avoids problems when starting the engine.

- The heating must be activated every time you want to set off. Similarly, the departure time must reactivate each time.
- The control lamp  (fuel level indicator) lights up.

auxiliary heater is switched off again after a certain time.

Note

- **Noises will be heard while the auxiliary heater is running.**
- **When the air humidity is high and the inside temperature low, condensation from the heating and ventilating system may evaporate when the auxiliary heater is switched on. In this case, steam may be released from underneath the vehicle. This does not mean that there is a vehicle malfunction.**
- **If the vehicle is tilted, e.g. if parked on a slope, the operation of the auxiliary heater may be restricted if the fuel tank level is low (just above the reserve level).**
- **If the auxiliary heater is used a number of times for a long period of time, the 12-volt battery will lose its charge. To recharge the battery, the vehicle must be driven for a number of kilometres from time to time. As a guideline: The journey should last approximately as long as the heater was connected.**
- **At temperatures below +5°C (+41°F), the auxiliary heater may switch itself on automatically when the engine is switched on. The**

Driving

Start and stop the engine

Switching the ignition on and starting the engine with the key

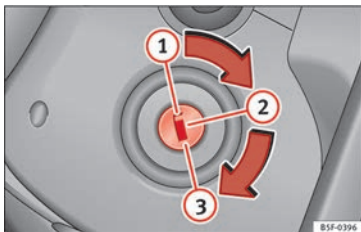


Fig. 163 Ignition key positions.

Read the additional information carefully

» page 23

Diesel engines can take a few seconds longer than usual to start on cold days. Therefore the clutch pedal (manual gearbox) or the brake pedal (automatic gearbox) must remain pressed until the engine starts up. During preheating, the warning lamp remains lit.

The preheating time depends on the coolant and exterior temperatures. With the engine at operating temperature, or at outside temperatures above +8°C, the warning lamp will

light up for about one second. This means that the engine starts *immediately*.

If the engine does not immediately start up, interrupt the starting process and try again after 30 seconds. To start the engine again, return the key to position 1.

Start-Stop System*

If the vehicle is stopped and the Start-Stop system* switches off the engine, the ignition remains switched on.

Automatic gearbox: before leaving the vehicle, make sure that the ignition is switched off and the selector lever is in position **P**.

Driver messages on the instrument panel display

Press the clutch

This message appears on vehicles with a manual gearbox if the driver tries to start the engine without having the clutch pedal pressed. The engine will only start if you press the clutch pedal.

Press the brake

This message appears on vehicles with an automatic gearbox if the driver tries to start the engine without having the brake pedal pressed.

Select N or P

This message appears if you try to start or stop the engine when the selector lever of the automatic gearbox is not in position **P** or **N**. The engine can only start or stop in certain positions.

Engage position P; the vehicle can move; doors can only close in position P.

For safety reasons, this driver message appears and an audible warning sounds if the selector lever of the automatic gearbox is not in position **P** after you switch off the ignition. Put the selector lever in position **P**, otherwise the vehicle could roll away.

Gear change: selector lever in the drive position!

This driver message is displayed when the selector lever is not in the position **P** when the driver door is opened. Additionally, a buzzer will sound. Put the selector lever in position **P**, otherwise the vehicle could roll away.

Ignition is switched on

This driver message is displayed and a buzzer is sounded when the driver door is opened with the ignition switched on. »

WARNING

- Never run the engine in confined spaces, as the exhaust gases are poisonous.



CAUTION

Avoid high engine speeds, full throttle and extreme load conditions until the engine has reached its normal operating temperature, otherwise this can damage the engine.

For the sake of the environment

Do not warm up the engine by idling it. You should drive off as soon as you start the engine. This will help avoid unnecessary exhaust emissions.


Note

- If it is difficult to turn the ignition key to the position , turn the steering wheel to both sides to release the steering lock.
- When starting from cold, the engine may be a little noisy for the first few seconds until oil pressure has built up in the hydraulic valve lifters. This is quite normal, and no cause for concern.
- If the vehicle battery is disconnected and reconnected, the key must remain in the position  for around 5 seconds before starting up.
- Vehicles with automatic gearbox: after switching off the ignition, you can only remove the ignition key if the selector lever is

in position "P" (parking lock). Next, the selector lever is locked.



Switching off the engine with the key

Switching off the engine

- Stop the vehicle.
- Turn the ignition key to position 
 - » **Fig. 163.**

Engaging the steering wheel lock

In vehicles with automatic gearbox, the ignition key can only be removed when the selector lever is in position P.

- Remove the key from the ignition in position  » **Fig. 163** » .
- Turn the steering wheel until you hear it engage.

Possible vehicle theft is prevented with the steering lock engaged.

WARNING

- Never switch the engine off until the vehicle is stationary. The brake servo and power steering functions will not be completely covered under warranty. More force may also be needed to turn the steering wheel or to brake. As you cannot steer and brake in the normal manner, there is a greater risk of accidents and serious injury.

- Never remove the key from the ignition if the vehicle is in motion. Otherwise, the steering could suddenly lock, making it impossible to steer the vehicle: risk of accident!

- Always take the key with you when you leave the vehicle. This is particularly important if there are children in the vehicle, as they might otherwise be able to start the engine or use power-operated equipment (e.g. the electric windows), which could cause injuries.

CAUTION

If the engine has been running under high load for a long time, there is a risk of heat building up in the engine compartment after it has been switched off; this could cause engine damage. For this reason, you should idle the engine for approximately 2 minutes before you switch it off.

Note

- After the engine is switched off the radiator fan may run on for up to 10 minutes, even if the ignition is switched off. It is also possible that the fan turns itself on once more if the coolant temperature increases due to the heat accumulated in the engine compartment or due to its prolonged exposure to solar radiation.
- If the vehicle is stopped and the Start-Stop system* switches off the engine, the ignition

remains switched on. Make sure that the ignition is switched off before leaving the vehicle, otherwise the battery could discharge.

Starter button*

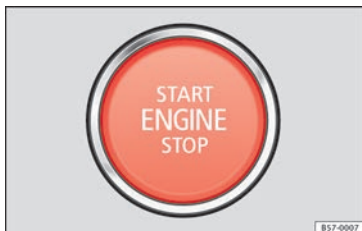


Fig. 164 In the lower part of the centre console: starter button.

The vehicle engine can be started with a starter button (Press & Drive). To do so, there must be a valid key inside the vehicle in the area of the front or rear seats.

In vehicles with the Keyless Access **>>> page 112** system, the engine can also be started with the key in the luggage compartment.

Opening the driver's door **when exiting the vehicle** activates the electronic lock on the steering column if the ignition is disabled.

Switching the ignition on/off manually

Briefly push the starter button without touching the brake or clutch pedal **>>> ⚠**.

For vehicles with both manual and automatic transmission, the starter button text **(START ENGINE STOP)** flashes like a heartbeat when the system is preset for switching the ignition on and off.

Automatic ignition switch-off

If the driver leaves the vehicle, taking the vehicle key with them but leaving the ignition on, the ignition is switched off automatically after a certain time. If at that time the dipped beam is on, the parking lights will stay on for approx. 30 minutes. The side light can be turned off by blocking the vehicle **>>> page 112** or manually **>>> page 131**.

Emergency starting function

If no valid key is detected inside the vehicle, an emergency start-up will be required. The relevant message will appear in the dash panel display. This may happen when, for example, the battery of the vehicle key button is very low or flat:

- Immediately after pushing the starter button, keep the vehicle key next to the right trim of the steering column.
- The ignition connects and the engine starts automatically.

Emergency disconnection

If the engine does not switch off after briefly pressing the starter button, an emergency disconnect will be required:

- Press the starter button twice within 3 seconds or press it once for more than 1 second **>>> ⚠**.
- The engine turns off automatically.

Engine restart feature

If no valid key is detected inside the vehicle after the engine stops, you will only have 5 seconds to restart it. A warning will display on the dash panel screen.

After this interval, it will not be possible to start the engine without a valid key inside the vehicle.

Automatic deactivation of the ignition on vehicles with the Start-Stop system

The ignition is switched off automatically when the vehicle is stopped and the automatic engine shutdown is active, if:

- The driver's seat belt is not fastened,
- the driver does not step on any pedal,
- the driver door is opened.

After automatically turning off the ignition, if the dipped beam **Ⓛ** is on, the side light remains on for approx. 30 minutes (if the battery is sufficiently charged). If the driver locks **>>**

the vehicle or manually turns off the light, the side light goes out.

WARNING

Any accidental movement of the vehicle could result in serious injury.

- When switching on the ignition, *do not* press the brake or clutch pedal, otherwise the engine could start immediately.

WARNING

If vehicle keys are used negligently or without due care, this may cause accidents and serious injury.

- Never leave any key inside the vehicle when exiting. Otherwise, a child or unauthorised person could lock the vehicle, start the engine or connect the ignition and, in this way, operate electronic equipment (e.g. the windows).

Note

- Before leaving the vehicle, always disconnect the ignition manually and, if appropriate, take into account the instructions on the screen of the dash panel.
- If the vehicle is stationary for a long time with the ignition on, the vehicle battery might be discharged and it might not be possible to start the engine.
- In diesel vehicles, there may be a delay in the engine starting if it requires preheating.

- If during the **STOP** phase you press the **START ENGINE STOP** button, the ignition is switched off and the button flashes.

- If the indication “Start-Stop system deactivated: Start the engine manually” is displayed on the dash panel display, the **START ENGINE STOP** button will blink.

Starting the engine

✓ Valid for vehicles: with Keyless Access

Step	Starting the engine with the starter button » page 167 (Press & Drive).
1.	Press and hold the brake pedal until step 5 is performed.
1a.	In vehicles with a manual gearbox: press and hold the clutch down until the engine starts.
2.	Put the gearbox lever in neutral or the selector lever in position P or N .
3.	Briefly press the starter button » Fig. 164 without pressing the accelerator. For the engine to start there must be a valid key in the vehicle. After starting the engine, the light of the START ENGINE STOP button changes to a fixed light indicating that the engine has started.
4.	If the engine does not start, stop and wait for approx. 1 minute before trying again. If necessary, perform an emergency start » page 167.
5.	Disconnect the electronic parking brake when you are about to start driving » page 170.

WARNING

Never leave the vehicle with the engine running, especially if a gear or gear range is engaged. The vehicle could then suddenly move or something strange could happen that would cause damage, fire or serious injury.

WARNING

Cold start sprays could explode or cause a sudden increase in the engine speed.

- Never use sprays to cold start the engine.

CAUTION

- The starter motor or the engine may be damaged if you try to start the engine while driving or if you restart it immediately after switching it off.
- If the engine is cold, avoid high engine speeds, pushing the engine too hard and rapid acceleration.
- Do not start the engine by pushing the vehicle or towing it. Unburnt fuel could enter the catalytic converter and damage it.


Note

- Do not wait until the engine warms up with the vehicle stationary; if you have good visibility through the windows, start driving immediately. This helps the engine reach operating temperature faster and reduces emissions.

- Electrical components with a high power consumption are switched off temporarily when the engine starts.
- When starting with a cold engine, noise levels may briefly increase. This is quite normal, and no cause for concern.
- When the outside temperature is below +5°C (+41°F), if the engine is diesel, some smoke may appear under the vehicle when the fuel-operated auxiliary heater is on.

Stopping the engine

✓ Valid for vehicles: with Keyless Access

Step	Switch off the engine with the starter button » page 167.
1.	Stop the vehicle completely »  .
2.	Press and hold the brake pedal until the step 4 is performed.
3.	If you are driving an automatic vehicle, place the selector lever in position P.
4.	Connect the electronic parking brake » page 170.
5.	Briefly press the start-up button » Fig. 164. The (START ENGINE STOP) button blinks again. If the engine fails to switch off, perform an emergency disconnect » page 167.
6.	If the vehicle is equipped with a manual gearbox, put it into 1st or reverse.

WARNING

Never switch off the engine while the vehicle is moving. This could cause loss of control of the vehicle, accidents and serious injury.

- The airbags and belt tensioners do not work when the ignition is switched off.
- The brake servo does not work with the engine off. Therefore, you need to press the brake pedal harder to brake the vehicle.
- Power steering does not work when the engine is not running. You need more strength to steer when the engine is switched off.
- If the ignition is switched off, the steering column could be locked, making it impossible to control the vehicle.

CAUTION

If the engine is made to work hard for a long time, it may overheat after being switched off. To prevent damage to the engine before switching it off, leave it idle for approx. 2 minutes in neutral.

Note

After switching off the engine, the cooling fan may continue to operate in the engine compartment for a few more minutes, even with the ignition off. The radiator fan is automatically switched off.

“My Beat” Function

For vehicles with a convenience key there is the “My Beat” function. This feature provides an additional indication of the vehicle ignition system.

When accessing the vehicle, e.g. by opening the doors with the remote control, the **(START ENGINE STOP)** button flashes, calling attention to the relevant starter system button.

Upon switching the ignition on/off, the light of the **(START ENGINE STOP)** button flashes. With the engine switched off, after a few seconds, the **(STOP ENGINE START)** button stops flashing and goes out.

With the engine running, the **(START ENGINE STOP)** button light stays on, indicating that the engine is running. Upon switching the ignition off with the **(START ENGINE STOP)** button, it starts flashing again.

In vehicles with the Start-Stop system, the “My Beat” function also offers additional information:

- When the engine stops during the Stop phase, the light of the **(START ENGINE STOP)** button stays on, since, even though the engine is off, the Start-Stop system is active.
- When the engine cannot be started again with the Start-Stop system, » page 188, and needs to be started manually, the

»

START ENGINE STOP button flashes to indicate this fact.

Braking and parking

Electronic parking brake



Fig. 165 In the lower part of the centre console: electronic parking brake button.

The electronic parking brake replaces the handbrake.

Activating the electronic parking brake

The electronic parking brake can be activated whenever the vehicle is at a standstill, even when the ignition is switched off. Activate it whenever you leave or park the vehicle.

- Pull and hold the **Ⓜ** **»» Fig. 165** button.
- The parking brake is activated when the control light of the **»» Fig. 165** button (arrow)

and the **red Ⓜ** control light of the display in the dash panel are on.

- Release the button.

Releasing the electronic parking brake

- Switch the ignition on.
- Press the button **Ⓜ** **»» Fig. 165**. At the same time step hard on the brake pedal or, if the engine is running, press the accelerator pedal slightly.
- The control light of the **»» Fig. 165** button (arrow) and the **red Ⓜ** control light of the display in the dash panel go out.

Automatic release of the electronic parking brake on starting the engine

The electronic parking brake is automatically switched off when starting if, after the driver's door is closed and the driver's seat belt fastened, **any** of the following situations take place:

- On vehicles with an automatic gearbox: A gear range is engaged or the vehicle is switched to another one and the accelerator pedal is lightly pressed.
- In vehicles with a manual gearbox: The clutch pedal is pressed fully before starting off and the accelerator is pedal lightly pressed.
- To facilitate certain manoeuvres there are exceptions that allow the automatic parking

brake to be released without the driver's seat belt being fastened.

The parking brake can be prevented from being automatically released by continuously pulling up the **Ⓜ** **»» Fig. 165** switch when starting off.

The electronic parking brake is not disconnected until the **Ⓜ** button is released. This can facilitate starting off when a heavy load is towed **»» page 255**.

Automatic activation of the electronic parking brake on starting the engine


In vehicles with automatic transmission, the electronic parking brake is activated automatically when exiting the vehicle incorrectly if:

- The selector lever is in the **D/S** or **R** position or in the Tiptronic selection track.
- **AND:** the vehicle is stationary.
- **AND:** the driver door is open.

Emergency braking function

Only use the emergency brake function if you are unable to stop the vehicle with the foot brake **»» ⚠**.

- Pull and hold the **Ⓜ** **»» Fig. 165** button in this position to **forcefully** stop the vehicle. At the same time, an acoustic warning can be heard.

- To stop the braking process, release the  button or press the accelerator.

WARNING


The improper use of the electronic parking brake can cause accidents and serious injury.

- Never use the electronic parking brake to stop the vehicle, unless it is an emergency. Braking distances can be considerably longer, since, under certain circumstances, only the rear wheels brake. Always use the foot brake.
- Never accelerate from the engine when a gear range or a gear is engaged and the engine is running. The vehicle could move, even if the electronic parking brake is activated.

CAUTION

To prevent the vehicle from unintentionally moving when parking it, first apply the electronic parking brake and then remove your foot from the brake pedal.

Note

- In vehicles with a manual gearbox, releasing the clutch and accelerating at the same time automatically disconnects the electronic parking brake.
- If the vehicle battery is flat, it will not be possible to disconnect the electronic parking brake. Use the jump-start »  page 58.

- When the electronic parking brake is applied or released, noises may be heard.
- The system performs automatic and audible tests sporadically in the parked vehicle if some time elapses without the electronic parking brake being used.

Parking

The electronic parking brake should always be applied when the vehicle is parked.

Always note the following points when parking the vehicle:

- Use the brake pedal to stop the vehicle.
- Apply the electronic parking brake.
- Put it in 1st gear.
- Switch the engine off and remove the key from the ignition. Turn the steering wheel slightly to engage the steering lock.
- Never leave a vehicle key in the vehicle.

Additional notes on parking the vehicle on gradients:

Turn the steering wheel so that the vehicle rolls against the kerb if it started to roll.

- If the vehicle is parked facing **downhill**, turn the front wheels so that they point *towards the kerb*.

- If the vehicle is parked facing **uphill**, turn the front wheels so that they point *away from the kerb*.
- Secure the vehicle as usual by applying the electronic parking brake firmly and putting it in 1st gear.

WARNING

- Take measures to reduce the risk of injury when you leave your vehicle unattended.
- Never park where the hot exhaust system could ignite inflammable materials, such as dry grass, low bushes, spilt fuel etc.
- Never allow vehicle occupants to remain in the vehicle when it is locked. They would be unable to open the vehicle from the inside, and could become trapped in the vehicle in an emergency. In the event of an emergency, locked doors will delay assistance to vehicle occupants.
- Never leave children alone in the vehicle. They could set the vehicle in motion, for example, by releasing the electronic parking brake or the gearshift lever, which would cause the vehicle to move, but uncontrollably.
- Depending on weather conditions, it may become extremely hot or cold inside the vehicle. This can be fatal.

Information on the brakes

New brake pads

For the first 400 km (250 miles), new brake pads have not yet reached their maximum braking capacity, and need to be “run in” first. However, you can compensate for the slightly reduced braking effect by applying more pressure on the brake pedal. Avoid overloading the brakes while running them in.

Wear

The rate of wear on the **brake pads** depends a great deal on how you drive and the conditions in which the vehicle is operated. This is a particular problem in urban traffic and short stretches, or with very sporty driving.

Depending on the speed, the braking force and the environmental conditions (for example, the temperature, air humidity, etc.) noises may be produced on braking.

Wet roads or road salt

In certain situations (for example, on driving through flooded areas, in severe downpours or after washing the vehicle) the braking action could be delayed if the discs and pads are damp, or frozen in winter. In this case the brakes should be “dried” by pressing the brake pedal several times.

At high speed and with the windscreen wipers activated, the brake pads will briefly touch the brake discs. This takes place, although unnoticeable to the driver, at regular intervals to improve the response time of the brakes when they are wet.

The effectiveness of the brakes can also be temporarily reduced if the vehicle is driven for some distance without using the brakes when there is a lot of salt on the road in winter. The layer of salt that accumulates on the discs and pads can be removed by gently applying the brakes a few times.

Corrosion

There may be a tendency for corrosion to form on the discs and dirt to build up on the brake pads if the vehicle is used infrequently or the brakes are not used very often.

If the brakes are not used frequently, or if rust has formed on the disks, it is advisable to clean off the pads and disks by braking firmly a few times at a moderately high speed >>> ⚠.

Fault in the brake system

If the brake pedal travel should ever increase *suddenly*, this may mean that one of the two brake circuits has failed. Drive immediately to the nearest specialised workshop and have the fault repaired. Drive there slowly and remember that you will have to apply

more pressure on the brake pedal and allow for longer stopping distances.

Low brake fluid level

Malfunctions can occur in the brake system if the brake fluid level is too low. The brake fluid level is monitored electronically.

Brake servo

The brake servo increases the pressure you apply to the brake pedal. It works only when the engine is running.

⚠ WARNING

- **Apply the brakes heavily to clean the brake system only in a suitable traffic situation. Do not put other road users in danger: there is risk of causing an accident.**
- **Ensure the vehicle does not move while in neutral, when the engine is stopped. Failure to follow this instruction could result in an accident.**
- **If the brake fluid loses its viscosity and is subjected to heavy use, vapour bubbles can form in the brake system. This reduces the efficiency of the brakes.**

ⓘ CAUTION

- **Never let the brakes “drag” by leaving your foot on the pedal when it is not necessary to brake. This overheats the brakes, resulting in longer stopping distances and greater wear.**

- Before driving down a long, steep gradient, it is advisable to reduce speed and select a lower gear. This makes use of engine braking and relieves the brakes. If you still have to use the brakes, it is better to brake firmly at intervals than to apply the brakes continuously.


Note

- If the brake servo is out of action, for example when the car is being towed, you will have to press the brake pedal considerably harder than normal to make up for the lack of servo assistance.
- If you wish to equip the vehicle with accessories such as a front spoiler or wheel covers, it is important that the flow of air to the front wheels is not obstructed, otherwise the brakes can overheat.

Front assist system

Electronic stability control (ESC)

The ESC helps to improve safety. It reduces the tendency to skid and improves the stability and roadholding of the vehicle. The ESC detects critical handling situations, such as vehicle understeer or oversteer, or wheelspin on the driving wheels. It stabilises the vehicle by braking individual wheels or by reducing the engine torque. The warning lamp will

flash on the instrument panel when the ESC is intervening .

The ESC includes the anti-lock brake system (ABS), the front assist system (HBA), the traction control system (ASR), electronic differential lock (EDS), electronic torque control (XDS) and tractor-trailer sway mitigation*. ESC also helps stabilise the vehicle by changing the torque.

Anti-lock brake system (ABS)

ABS prevents the wheels from locking up under braking until the vehicle has reached a virtual standstill. You can continue to steer the vehicle even when the brakes are on full. Keep your foot on the brake pedal and do not pump the brakes. You will feel the brake pedal pulsate while the ABS is working.

Front assist system (HBA)

The brake assist system can reduce the required braking distance. The braking force is automatically boosted if you press the brake pedal quickly in an emergency. You must keep pressing the brake pedal until the danger has passed.

Traction control system (ASR)

In the event of wheelspin, the traction control system reduces the engine torque to match the amount of grip available. This helps the

car to start moving, accelerate or climb a gradient.

Electronic differential lock (EDL)

When the EDL detects wheelspin, it brakes the spinning wheel and directs the power to the other driven wheel. This function is active up to approximately 100 km/h (62 mph).

To prevent the disc brake of the braked wheel from overheating, the EDL cuts out automatically if subjected to excessive loads. The vehicle can still be driven. The EDL will switch on again automatically when the brake has cooled down.

Tractor-trailer sway mitigation*

If the vehicle is pulling a trailer, it will control the following: Tractor-trailers tend to sway. When the swaying of the trailer is felt by the vehicle and detected by the ESC, it will automatically brake the towing vehicle within the limits of the system and mitigate the sway. Tractor-trailer sway mitigation is not available in all countries.

Electronic torque management (XDS)

When taking a curve, the driveshaft differential mechanism allows the outer wheel to turn at a higher speed than the inner wheel. In this way, the wheel that is turning faster (outer wheel) receives less drive torque than the inner wheel. This may mean that in certain **»**

situations the torque delivered to the inner wheel is too high, causing the wheels to spin. On the other hand, the outer wheel is receiving a lower drive torque than it could transmit. This causes an overall loss of lateral grip on the front axle, resulting in understeer or “lengthening” of the trajectory.

The XDS system can detect and correct this effect via the sensors and signals of the ESC.

Via the ESC, the XDS will brake the inside wheel and counter the excess driving torque of that wheel. This means that the driver’s desired trajectory is much more precise.

The XDS system works in combination with the ESC and is always active, even when ASR traction control is disconnected, or the ESC in Sport mode or disconnected.

Multi-collision brake

In an accident, the multi-collision brake can help the driver by braking to avoid the risk of skidding during the accident, which could lead to further collisions.

The multi-collision brake works for front, side or rear accidents, when the airbag control unit records its activation level and the accident takes place at a speed of over 10 km/h (6 mph). The ESC automatically brakes the vehicle, as long as the accident has not damaged the ESC, the brake hydraulics or the on-board network

The following actions control automatic braking during the accident:



- When the driver presses the accelerator, the automatic braking does not take place.
- When the braking pressure through pressing the brake pedal is greater than the system’s braking pressure the vehicle will brake automatically.
- Multi-collision braking will not be available if ESC is malfunctioning.

WARNING

- **The ESC, ABS, ASR, EDS and the electronic torque control system cannot exceed the limits imposed by the laws of physics. Always bear this in mind, especially on wet or slippery roads. If you notice the systems cutting in, you should reduce your speed immediately to suit the road and traffic conditions. Do not be encouraged to take risks by the presence of more safety systems. If you do, an accident may occur.**
- **Please remember that the accident risk always increases if you drive fast, especially in corners or on a slippery road, or if you follow too close behind the vehicle in front of you. The ESC, ABS, brake assist, EDS and the electronic torque control system cannot prevent accidents: risk of accidents!**
- **Accelerate with caution on slippery surfaces (for example, icy or snow-covered). Despite the control systems, the driven wheels**

could spin, affecting the stability of the vehicle: risk of accident!

Note

- **The ABS and ASR will only operate correctly if the four wheels have identical tyres. Any differences in the rolling radius of the tyres can cause the system to reduce engine power when this is not desired.**
- **The regulating processes of the systems can make noises when they intervene.**
- **If the warning lamp  lights up, or  alternatively, there could be a fault » page 106.**

Switching on/off the ESC and ASR

The ESC is switched on automatically when the engine is started, and only works when the engine is running and includes the ABS, EDS and ASR systems.

The ASR function should only be switched off in situations in which traction is insufficient, including:


- When driving in deep snow or on surfaces that are not very firm.
- To “free” the vehicle if it gets stuck.

Then switch the ASR function back on.

Depending on the finishes and versions, there is the possibility of disconnecting only the ASR or activating the ESC Sport mode.


Disable ASR

The Easy Connect system menu is used to switch off the ASR » page 108. The traction control system will be disabled.


The control lamp  lights up. For vehicles with a driver information system* the driver will be informed that **ASR is disabled**.


Activate ASR

The Easy Connect system menu » page 108 is used to switch on the ASR. The traction control system will be enabled.

The control lamp  switches off. For vehicles with a driver information system* the driver will be informed that **ASR is enabled**.


ESC in “Sport” mode

Sport mode can be connected via the Easy Connect » page 108 system menu. The action of the ESC and the ASR is limited » .

The control lamp  lights up. For vehicles with a driver information system* the driver will be informed that:

Electronic Stability Control (ESC): sport. Warning! Limited stability


Disable ESC “Sport” mode

Through the Easy Connect system menu » page 108. The warning lamp  will switch off. For vehicles with a driver information system* the driver will be informed that:

Electronic Stability Control (ESC): On

ESC in “Offroad”¹⁾ mode

Turn the Driving Experience button to select the Offroad mode and connect it » page 226. The interventions of the ESC, as well as of the ASR, EDS and the ABS, adapt to irregular terrain.

The control lamp  lights up. In the dash panel, the driver will be informed that:


Electronic Stability Control (ESC): Offroad. Warning! Limited stability

In the following exceptional situations it may make sense to activate the Offroad mode to allow the wheels to spin:

- When “swinging” the vehicle to get it unstuck.
- Driving in deep snow or on loose surfaces.
- When driving on rough terrain with much of the car’s weight is lifted off the wheels (axle articulation).
- Steep descents with braking on unpaved terrain.

For your safety we recommend that you turn off the Offroad mode when it is not absolutely necessary.

Disable the ESC Offroad mode

Turn the Driving Experience button to select a different driving mode » page 226. The warning lamp  will switch off. The driver will be informed that:

Electronic Stability Control (ESC): On

ESC in “Snow” mode¹⁾

Turn the Driving Experience button to select the “Snow” mode and connect it » page 226. Traction control system (ASR) interventions adjust to the adhesion of snowy roads.

¹⁾ Only for 4Drive models.

Disable the ESC “Snow” mode

Turn the Driving Experience button to select a different driving mode »» page 226.

WARNING

The ESC Sport mode should be activated only when traffic conditions and the ability of the driver allow it. Danger of skidding!

- With ESC in Sport mode, the stabilising function will be limited to allow for a sportier drive. The driving wheels could spin and the vehicle could skid.

WARNING

You should only activate the Offroad Mode or disable the ASR if the experience of the driver and traffic conditions allow it. Danger of skidding!

- With the Offroad mode activated, the stabilisation function is limited. In particular, if the road is too smooth and slippery, the driving wheels could spin and the vehicle could skid.

Note

If the ASR is disconnected or the ESC's Sport mode is selected, cruise control* will be switched off.

Manual gearbox

Changing gear

Read the additional information carefully



»»  page 40

In some countries the clutch pedal must be fully pressed down for the engine to start.

Selecting reverse gear

- Engage reverse gear only when the vehicle is stopped.

Changing down gears

While driving, changing down a gear must always be done gradually, i.e. to the gear directly below and when the engine speed is not too high »» . Changing down while bypassing one or various gears at high speeds or at high engine speeds can damage the clutch and the gearbox, even if the clutch pedal remains depressed »» .

WARNING

When the engine is running, the vehicle will start to move as soon as a gear is engaged and the clutch released. This is also the case with the electronic parking brake switched on.

- Never engage reverse gear when the vehicle is moving.

WARNING

If the gear is changed down inappropriately by selecting a gear that is too low, you may lose control of the vehicle, causing an accident and serious injuries.

CAUTION

When travelling at high speeds or at high engine speeds, selecting a gear that is too low can cause considerable damage to the clutch and the gearbox. This can also occur if the clutch pedal is pressed and held and it does not engage.

CAUTION

To prevent damage and avoid premature wear, please observe the following:

- Do not rest your hand on the gear lever while driving. The pressure applied by your hand is transmitted to the gearbox selector forks.
- Always ensure that the vehicle is completely stopped before engaging the reverse gear.
- Always press the clutch to the floor when changing gears.
- Never hold the vehicle “on the clutch” on hills with the engine on.


Automatic gearbox/DSG automatic gearbox*

Introduction

Your vehicle is equipped with an electronically controlled manual gearbox. Torque between the engine and the gearbox is transmitted via two independent clutches. They replace the torque converter found on conventional automatic gearboxes and allow for smooth, uninterrupted acceleration of the vehicle.

The **tiptronic** system allows the driver to change gears *manually* if desired
 » page 179, Changing gears in tiptronic mode*.


Selector lever positions

Read the additional information carefully
 »  page 41

The selector lever position engaged is highlighted on the display in the instrument cluster. With the selector lever in the manual gearbox positions G, D, E and S, the engaged gear is also indicated on the display.


P – Parking lock

When the selector lever is in this position, the driven wheels are locked mechanically.

The parking lock must be engaged only when the vehicle is *stationary* » .

The interlock button (the button on the selector lever handle) must be pressed in *and* simultaneously the brake pedal must be depressed before moving the selector lever either in or out of position P.

R – Reverse gear

Reverse gear must be engaged only when the vehicle is *stationary* and the engine is idling
 » .

To move the selector lever to position R, the interlock button must be pressed in *and* at the same time the brake pedal must be depressed. The reverse lights come on when the selector lever is in the R position with the ignition on.

N – Neutral (idling)


With the selector lever in this position, the gear is in neutral.

D/S – Permanent drive (forward) position

The selector lever in the D/S position enables the gears to be controlled in normal mode (D) or Sport (S). To select Sport mode (S), move the selector lever backwards. Moving the lever again will select normal mode (D). The selected driving mode is shown on the instrument panel display.

In **normal mode** (D), the gearbox automatically selects the best gear ratio. This depends on the engine load, the road speed and the dynamic gear control programme (DCP).

Sport mode (S) must be selected for a sporty driving style. This setting makes use of the engine's maximum power output. When accelerating the gear shifts will be noticeable.

Press the brake pedal to move the selector lever from N to D/S when the vehicle is stationary or at speeds below 3 km/h (2 mph)
 » .

Under certain circumstances (e.g. when driving in mountains) it can be advantageous to switch temporarily to tiptronic mode
 » page 179, in order to *manually select* gear ratios to suit the driving conditions.


WARNING

- Take care not to accidentally press the accelerator pedal when the vehicle is stopped. The vehicle could otherwise start moving immediately (in some cases even if the parking brake is engaged) resulting in the risk of an accident.
- Never move the selector lever to R or P when driving. Failure to follow this instruction could result in an accident.
- With selector lever in any position (except P) the vehicle must always be held with the foot brake when the engine is running. This is because an automatic gearbox still transmits

power even at idling speed, and the vehicle tends to “creep”. The accelerator pedal must on no account be pressed inadvertently when a gear is engaged with the vehicle stationary. The vehicle could otherwise start moving immediately (in some cases even if the parking brake is engaged) resulting in the risk of an accident.

- While you are selecting a gear and the vehicle is stopped with the engine running, do not accelerate. Failure to follow this instruction could result in an accident.
- As a driver you should never leave your vehicle if the engine is running and a gear is engaged. If you have to leave your vehicle while the engine is running, you must apply the handbrake and engage the parking lock (P).
- To avoid accidents, apply the handbrake and put the selector lever in position P before opening the bonnet and working on the vehicle with the engine running. Please always observe the important safety warnings »» page 282, Work in the engine compartment.

Note

- If the selector lever is moved accidentally to N when driving, release the accelerator and let the engine speed drop to idling before selecting gear range D or S again.
- Should the power supply to the selector lever be interrupted in position P, the selector lever will be locked. If this should happen the manual release can be used »»  page 41.

Selector lever lock

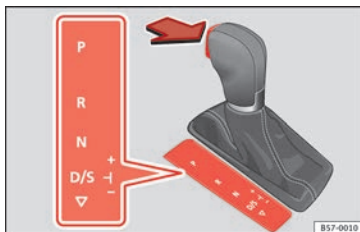


Fig. 166 Selector lever lock.

The selector lever lock prevents gears from being engaged inadvertently, so that the vehicle is not set in motion unintentionally.

The selector lever lock is released as follows:

- Switch the ignition on.
- Press the brake pedal *and*, at the same time, hold the lock button in the direction of the arrow »» Fig. 166.

Automatic selector lever lock

With the ignition switched on, the selector lever is locked in the positions P and N. The brake pedal must be pressed to release the lever while pressing the release button if the selector lever is in the position P. As a reminder for the driver, with the lever in positions P or N the following message will be shown on the display:

When stationary, apply footbrake while selecting a gear.

Level lock only engages with the vehicle stationary and at speeds of up to 5 km/h (3 mph). At speeds of over 5 km/h (3 mph) the lever lock is automatically deactivated in position N.

The selector lever lock is not engaged if the selector lever is moved quickly through position N (e.g. when shifting from R to D). This makes it possible, for instance, to rock the vehicle “backwards and forwards” if it is stuck. The selector lever lock engages automatically if the brake pedal is not depressed and the lever is in position N for more than about two seconds.

Interlock button

The interlock button on the selector lever handle prevents the driver from inadvertently engaging certain gears. Press the button in to disengage the selector lever lock.

Safety interlock for ignition key

Once the ignition has been turned off, the key may be removed only if the gear selector is in position P. While the key is not in the ignition, the selector lever is locked in position P.

 Note

- If the selector lever lock does not engage, there is a fault. The transmission is interrupted to prevent the vehicle from accidentally moving. Follow the procedure below in order for the selector lever lock to engage again:
 - With a 6-speed gearbox: press the brake pedal and release it again.
 - With a 7-speed gearbox: press the brake pedal. Move the selector lever to position P or N and subsequently engage a gear.
- Despite a gear being engaged, the vehicle does not move forwards or back. Proceed to the next mode:
 - When the vehicle does not move in the required direction, the system may not have the gear range correctly engaged. Press the brake pedal and engage the gear range again.
 - If the vehicle still does not move in the required direction, there is a system malfunction. Seek specialist assistance and have the system checked.

Changing gears in tiptronic mode*

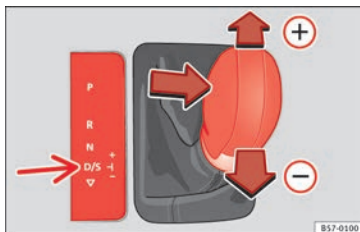


Fig. 167 Centre console: changing gear with tiptronic





Fig. 168 Steering wheel: automatic gearbox levers

The tiptronic gives the driver the option to change gears manually.



Changing gear manually with the selector lever

It is possible to change to tiptronic mode, both when the vehicle is stopped and while driving.

- To switch to tiptronic mode, move the selector lever from position D/S to the right. As soon as the change is made the selector level will be shown in the position **M** on the instrument panel display (for example **M4** means that the fourth gear is engaged).
- Move the selector lever forwards  to select a higher gear **»» Fig. 167**.
- Move the selector lever backwards  to select a lower gear.

Changing gear manually with the gearshift paddles*

The gearshift paddles can be used when the selector lever is in the position D/S or **M**.

- Press the gearshift paddle  to select a higher gear **»» Fig. 168**.
- Press the gearshift paddle  to select a lower gear.
- With the selector lever in position D/S, if no paddle is operated during a short period of time, the gearbox control system switches back to automatic mode. To switch to permanent manual gear change using the gearshift paddles, move the selector lever from position D/S to the right. **»»**

When accelerating, the gearbox automatically shifts up into the next gear shortly before the maximum engine speed is reached.

If you select a lower gear, the automatic gearbox will not shift down until there is no risk of over-revving the engine.

When the kick-down feature is used, the gearbox shifts down to a lower gear, depending on road speed and engine speed.

Driving tips

The gearbox changes gear ratios automatically as the vehicle moves.

The engine can only start with the selector lever in position P or N. At low temperatures, below -10°C (50°F), the engine can only start with the selector lever in position P.


Starting the vehicle

- Press and hold the brake pedal.
- Press and hold the interlock button (the button on the selector lever handle), move the selector lever to the desired position, for instance **D** » page 177, and release the interlock button.
- Wait for the gearbox to engage the gear (a slight movement can be felt).
- Release the brake and press the accelerator » » ⚠.

Stopping briefly

- Apply the foot brake to hold the vehicle briefly when stationary (for instance at traffic lights). Do not press the accelerator.

Stopping/Parking

If the driver door is opened and the selector lever is not in position P, the vehicle could move. The driver message will be:  **Gear change: selector lever in the drive position!**. Additionally, a buzzer will sound.

- Press and hold the brake pedal » » ⚠.
- Apply the handbrake.
- Move the selector lever to position P.

Holding the car on a hill

- *Always* apply the brake pedal firmly to prevent the vehicle from “moving backwards; if necessary, apply the handbrake” » » ⚠. Do **not** try to stop the vehicle “rolling back” by increasing the engine speed when a gear is engaged (pressing the accelerator) » » ⚠.

Starting off uphill

- Apply the handbrake.
- Once you have engaged a gear press the accelerator carefully and disengage the handbrake.

Driving down hills: in some situations (on mountain roads or when towing a trailer or caravan) it can be advantageous to switch temporarily to the manual gearbox programme so that the gear ratios can be selected manually to suit the driving conditions » » ⚠.

On level ground it is sufficient to move the selector lever to position P. On slopes, first engage the parking brake and then put the selection lever into the P position. This avoids overloading the locking mechanism and it will be easier to move the selector lever from position P.

⚠ WARNING


Observe the safety warnings » » ⚠ in Selector lever positions on page 177.

- **Never allow the brake to rub and do not use the brake pedal too often or for long periods. Constant braking causes overheating in the brakes. This could significantly reduce braking power, increase braking distance or even result in the total failure of the brake system.**
- **To avoid rolling back on gradients always hold the vehicle with the footbrake or handbrake if you have to stop.**

ⓘ CAUTION

- **If you stop the vehicle on a gradient, do not attempt to stop it from rolling by depressing the accelerator when a gear has been selected. This could cause overheating and**

damage the automatic gearbox. Apply the handbrake firmly or press the brake pedal in order to prevent the vehicle from rolling back.

- If you allow the car to roll with the selector lever in position N with the engine switched off, the automatic gearbox will be damaged as it will not be lubricated.
- In certain driving situations or traffic conditions, such as frequently starting, prolonged “creeping” of the vehicle or traffic jams with continuous stoppages, the gearbox could overheat causing damage! If the warning lamp  lights up, stop the vehicle as soon as possible and wait for the gearbox to cool
» page 183.

Kick-down feature

The kick-down feature allows maximum acceleration to be reached.

When the accelerator pedal is pressed right down past the point of resistance at full throttle, the gearbox will shift down to a lower gear, depending on road speed and engine speed. The upshift to the next higher gear is delayed until the engine reaches maximum rpm.

¹⁾ Vehicles without driver information system: the warning lamp flashes slowly/Vehicles with driver information system: the warning lamp stays on.

WARNING


Please note that if the road surface is slippery or wet, the kick-down feature could cause the driving wheels to spin, which could result in skidding.

Launch control programme

✓ Valid for vehicles: with Launch-Control/6-Speed DSG with diesel engines superior to 125 kW and petrol engines superior to 140 kW.

The Launch control programme enables maximum acceleration.

Important: the engine must have reached operating temperature and the steering wheel must not be turned.

The engine speed for launch-control is different on petrol and diesel engines. To use the launch-control you must disconnect the anti-slip regulation (ASR) through the Easy Connect system menu
» page 108. The warning lamp  will stay switched on or will flash slowly depending on whether or not the vehicle has a driver information system*.

On vehicles with the driver information system, the ESC lamp lights up permanently and the corresponding text message **Stability**


control deactivated (temporary) appears on the instrument panel to indicate the deactivation status.

- When the engine is running, switch off the traction control (ASR)¹⁾.
- Turn the selector lever to the position “S” or tiptronic, or else select the **sport** driving mode from the SEAT Drive Profile*
» page 225.
- Press the brake pedal firmly with your left foot and hold it down for at least one second.
- With your right foot, press the accelerator down to the full throttle or kick-down position. The engine speed will stabilise at about **3,200 rpm** (petrol engine) or about **2,000 rpm** (diesel engine).
- Take your left foot off the brake pedal.

WARNING

• Always adapt your driving style to the traffic conditions.

• Only use the launch control programme when road and traffic conditions permit, and make sure your manner of driving and accelerating the vehicle does not inconvenience or endanger other road users.
»

- Make sure that the ESC remains switched on. Please note that when the ASR and ESC are deactivated, the wheels may start to spin, causing the vehicle to lose grip. Risk of accident!
- After putting the vehicle into gear, the “sport” mode of the ESC should be deactivated again by briefly pressing the  button.

Note

- After using the Launch control programme, the temperature in the gearbox may have increased considerably. In this case, the programme could be disabled for several minutes. The programme can be used again after the cooling phase.
- Accelerating with the Launch control programme places a heavy load on all parts of the vehicle. This can result in increased wear and tear.

Downhill speed control*

The downhill speed control function helps the driver when driving down steep gradients.

Downhill speed control is activated when the selector lever is in D/S and the driver applies the foot brake. The automatic gearbox automatically engages a lower gear that is suitable for the slope. The downhill speed control

function attempts to maintain the speed at which the vehicle was travelling when the foot brake was applied (subject to the laws of physics and technical drive limitations). It may be necessary to adjust the speed again using the foot brake in certain situations. Given that the downhill speed control can only change down to 3rd gear, on very steep descents the tiptronic mode may be required. In this case, manually reduce the tiptronic to 2nd or 1st gear to use the engine brake and reduce the charge on the brakes.

Downhill speed control is deactivated as soon as the road levels out again or you press the accelerator pedal.

On vehicles with cruise control system* **»» page 193**, downhill speed control is activated when you set a cruising speed.

WARNING

The downhill speed control cannot defy the laws of physics. Therefore, speed cannot be maintained constant in all situations. Always be prepared to use the brakes!

Inertia mode

The inertia mode enables the kinetic energy of the vehicle to be harnessed enabling certain stretches to be driven without using the accelerator. This enables fuel to be saved.

Use the inertia mode to “let the vehicle roll” before, for example, arriving in a town.

Switching on inertia mode

Important: selector lever must be in position D, gradients below 12 %.

- Select, in SEAT Drive Profile*, **Eco** mode **»» page 225**.
- Take your foot off the accelerator.

The driver message **Inertia** will be displayed. At speeds higher than 20 km/h (12 mph), the gearbox will automatically disengage and the vehicle will roll freely, without the effect of the engine brake. While the vehicle rolls, the engine runs at idling speed.

Stopping inertia mode

- Press the brake or the accelerator pedal.

To make use of the braking force and switch off the engine again, simply press the brake pedal briefly.

Applying both the **inertia mode** (= prolonged section with less energy) and the **switching off using inertia** (= shorter section without the need for fuel) facilitates improved fuel consumption and emission balance.

⚠ WARNING

- If the inertia mode has been switched on, take into account, when approaching an obstacle and releasing the accelerator pedal, that the vehicle will not decelerate in the usual manner: risk of accident!
- When using inertia mode while travelling down hills, the vehicle can increase speed: risk of accident!
- If other users drive your vehicle, warn them about inertia mode.

i Note

- Inertia mode is only available in eco (SEAT Drive Profile*) driving mode.
- The driver message *Inertia* is only displayed with the current consumption. In inertia mode the gear will no longer be displayed (for example "E" will appear instead of "E7").
- On downhill sections with gradients above 15 %, the inertia mode will automatically be switched off temporarily.

Backup programme

A backup programme is in place if a fault should occur in the control system.

If all the positions of the selector lever are shown over a light background on the instrument panel display, there is a system fault and the automatic gearbox will operate in

with the backup programme. When the backup programme is activated, it is possible to drive the vehicle, however, at low speeds and within a selected range of gears. In some cases **driving in reverse gear may not be possible.**

ⓘ CAUTION

If the gearbox operates with the backup programme, take the vehicle to a specialised workshop and have the fault repaired without delay.

Clutch**⚠ Clutch overheating! Please stop!**

The clutch has overheated and could be damaged. Stop the vehicle and wait for the gearbox to cool with the engine at idling speed and the selector lever in position P. When the warning lamp and the driver message switch off, have the fault corrected by a specialised workshop without delay. If the warning lamp and the driver message do not switch off, do not continue driving. Seek specialist assistance.

Gearbox malfunctions**⚠ Gearbox: Fault! Stop the vehicle and place the lever in the position P.**

There is a fault in the gearbox. Stop the vehicle in a safe place and do not continue driving. Seek specialist assistance.

⚠ Gearbox: System fault! You may continue driving.

Have the fault corrected by a specialised workshop without delay.

⚠ Gearbox: System fault! You can continue driving with restrictions. Reverse gear disabled

Take the vehicle to a specialised workshop and have the fault repaired without delay.

⚠ Gearbox: System fault! You can continue driving in D until switching off the engine

Stop the vehicle in a safe place well away from moving traffic. Seek specialist assistance.

⚠ Gearbox: too hot. Adapt your driving accordingly

Continue driving at moderate speeds. When the warning lamp switches off, you can continue driving in a normal manner. **»**

⚙️ **Gearbox: press the brake and engage a gear again.**

If the fault was caused by a gearbox with a high temperature, this driver message will be displayed when the gearbox has cooled again.

Run-in and economical driving

Running-in the engine

A new vehicle should be run in over a distance of 1500 km (1000 miles). For the first 1,000 km the engine speed should not exceed 2/3 of the maximum permissible engine speed. In doing so, do not accelerate at full throttle and do not drive with a trailer! From 1000 to 1500 km (600 to 1000 miles) you can gradually increase the engine rpm and road speed.

During its first few hours of running, the internal friction in the engine is greater than later on when all the moving parts have bedded down.

How the vehicle is driven for the first 1,500 km influences the future engine performance. Subsequently, also drive at a moderate rate, especially when the engine is still cold: this will lead to less engine wear and tear and will prolong its useful life.

You should also avoid driving with the engine speed too *low*. Change down to a lower gear when the engine no longer runs “smoothly”. If the engine revs too much, cut fuel injection to protect the engine.

Environmental compatibility

Environmental protection is a top priority in the design, choice of materials and manufacture of your new SEAT.

Constructive measures to encourage recycling

- Joints and connections designed for easy dismantling
- Modular construction to facilitate dismantling
- Increased use of single-grade materials.
- Plastic parts and elastomers are marked in accordance with ISO 1043, ISO 11469 and ISO 1629.

Choice of materials

- Use of recycled materials.
- Use of compatible plastics in the same part if its components are not easily separated.
- Use of recycled materials and/or materials originating from renewable sources.

- Reduction of volatile components, including odour, in plastic materials.
- Use of CFC-free coolants.

Ban on heavy metals, with the exceptions dictated by law (Annex II of ELV Directive 2000/53/EC): cadmium, lead, mercury, hexavalent chromium.



Manufacturing methods

- Reduction of the quantity of thinner in the protective wax for cavities.
- Use of plastic film as protection during vehicle transport.
- Use of solvent-free adhesives.
- Use of CFC-free coolants in cooling systems.
- Recycling and energy recovery from residues (RDF).
- Improvement in the quality of waste water.
- Use of systems for the recovery of residual heat (thermal recovery, enthalpy wheels, etc.).
- The use of water-soluble paints.

Economical and environmentally-friendly driving

Fuel consumption, environmental pollution and wear to the engine, brakes and tyres depends largely on driving style. Fuel consumption can be reduced by 10-15% with an economical driving style and proper anticipation of traffic conditions. The following section gives you some tips on lessening the impact on the environment and reducing your operating costs at the same time.

Active cylinder management (ACT®)*display

Depending on vehicle equipment, the active cylinder management (ACT®) may automatically deactivate some of the engine cylinders if the driving situation does not require too much power. When it is switched off, no fuel is injected into these cylinders, hence total fuel consumption may be reduced. The number of active cylinders can be seen on the instrument panel display   page 30.

Foresight when driving

Acceleration causes the vehicle to consume more fuel. If you think ahead when driving, you will need to brake less and thus accelerate less. Wherever possible, let the car roll slowly to a stop, with a **gear engaged** (for instance when you can see that the next traffic lights are red). This takes advantage of the engine braking effect, reducing wear on the

brakes and tyres. Emissions and fuel consumption will drop to zero due to the overrun fuel cut-off.

Changing gear to save energy

An effective way of saving is to change *in advance* to a higher gear. Running the engine at high rpm in the lower gears uses an unnecessary amount of fuel.

Manual gearbox: shift up from first to second gear as soon as possible. In any case, we recommend that you change to a higher gear upon reaching 2,000 rpm. Choosing the right gear enables fuel savings. Select the highest possible gear appropriate for the driving situation (the engine should continue functioning with cyclical regularity).

Automatic gearbox: accelerate gradually and without reaching the “kick-down” position.

Avoid driving at high speed

Avoid travelling at top speed, whenever possible. Fuel consumption, emission of harmful gases and noise pollution multiply disproportionately as speed is increased. Driving at moderate speeds will help to save fuel.

Reduce idling time

In vehicles with the Start-Stop system idling is automatically reduced. In vehicles without the Start-Stop system it is worth switching off the engine, for example, at level crossings

and at traffic lights that remain red for long periods of time. When an engine has reached operating temperature, and depending on the cylinder capacity, keeping it switched off for a minimum of about 5 seconds already saves more than the amount of fuel necessary for restarting.

The engine takes a long time to warm up when it is idling. Mechanical wear and pollutant emissions are also especially high during this initial warm-up phase. It is therefore best to drive off immediately after starting the engine. Avoid running the engine at high speed.

Regular maintenance

Regular servicing helps in saving fuel even before the engine is started. A well-serviced engine gives you the benefit of **improved fuel efficiency** as well as maximum reliability and an enhanced resale value. A badly serviced engine can consume up to 10% more fuel than necessary.

Avoid short journeys

The engine and catalytic converter need to reach their optimal **operating temperature** in order to minimise fuel consumption and emissions.

A cold engine consumes a disproportionate amount of fuel. The engine reaches its working temperature after about four kilometres **»**

(2.5 miles), when fuel consumption will return to a normal level.

Check tyre pressure

Always make sure the tyres are inflated to the correct pressures » page 292 to save fuel. If the pressure is below half bar, fuel consumption may increase by 5%. Due to the greater rolling resistance, under-inflation **also** increases tyre wear and impairs handling.

Do not use **winter tyres** all year round as they increase fuel consumption by up to 10%.

Avoid carrying unnecessary loads

Given that every kilo of **extra weight** will increase the fuel consumption, it is advisable to always check the luggage compartment to make sure that no unnecessary loads are being transported.

Since the luggage rack increases the **aerodynamic drag** of the vehicle, you should remove it when not needed. At speeds of 100-120 km/h (62-75 mph), this will save 12% of fuel.

Save electrical energy

The engine drives the alternator, thereby generating electricity. This implies that any increase in power consumption also increases fuel consumption! For this reason, switch off any unneeded electrical devices. Devices that use a lot of electricity includes the blower at

a high setting, the rear window heating or the seat heating*.




Engine management and exhaust gas purification system

Introduction

WARNING

- Because of the high temperatures which can occur in the exhaust purification system (catalytic converter or diesel particulate filter), do not park the vehicle where the exhaust can come into contact with flammable materials under the car (e.g. on grass or at the forest edge). Fire hazard!
- Do not apply wax underneath the vehicle around the area of the exhaust system: Fire hazard!

Note

While the control lamps , , **EPC** or  remain lit, there may be engine problems, fuel consumption may increase and the engine may lose power.

Catalytic converter


- ✓ Applies to vehicles with petrol engine


The vehicle must only be used with unleaded petrol, otherwise the catalytic converter will be irreparably damaged.

Never drive until the tank is empty; an irregular supply of fuel can cause faulty combustion. In these cases, unburned fuel reaches the exhaust system, which can overheat and damage the catalytic converter.

Diesel particulate filter

- ✓ Applies to vehicles with diesel engine

The diesel engine particulate filter eliminates most of the soot from the exhaust gas system. Under normal driving conditions, the filter cleans itself. The diesel particulate filter is cleaned automatically without need for indication by the warning lamp . This may be noticed because the engine idle speed increases and an odour may be detected.

If automatic filter purification cannot be carried out (because only short trips are taken, for example), soot will accumulate on the filter and the Diesel particulate filter warning lamp will  switch on.

Facilitate the automatic filter cleaning process by driving in the following manner: drive for approximately 15 minutes at a minimum speed of 60 km/h (37 mph) in 4th or 5th gear

(automatic gearbox: gear S). Maintain the engine speed at approximately 2,000 rpm. The rise in temperature causes the soot on the filter to burn. On completion of the cleaning the warning lamp will switch off. If the warning lamp does not switch off, go immediately to a specialised workshop to rectify the problem.

Engine management* EPC

This warning lamp monitors the engine management system for petrol engines.

The warning lamp **EPC** (Electronic Power Control) lights up when the ignition is switched on while system operation is being verified. It should go out once the engine is started.

If there is a fault in the electronic engine management system while you are driving, this warning lamp will light up. Take the vehicle to a specialised workshop as soon as possible and have the engine checked.

Emission control system*

Control lamp flashes:

When there is misfiring that can damage the catalytic converter. Reduce speed and drive carefully to the nearest specialised workshop to have the engine checked.


The control lamp lights up:

If a fault has developed during driving which has reduced the quality of the exhaust gas (e.g. lambda probe fault). Reduce speed and drive carefully to the nearest specialised workshop to have the engine checked.


Engine pre-heating/fault system*

The warning lamp lights up to show that the glow plugs are preheating the diesel engine.

The control lamp lights up

If the control lamp  lights up when the engine is started it means that the glow plugs are preheating. The engine can be started straight away when the lamp switches off.

Control lamp flashes

If a fault develops in the engine management system while you are driving, the glow plug system lamp will flash . Take the vehicle to a specialised workshop as soon as possible and have the engine checked.

Driving tips

Driving on flooded roads

To prevent damage to the vehicle when driving through water, for example, along a flooded road, please observe the following:

- The water should never come above the lower edge of the bodywork.
- Drive at pedestrian speed.

WARNING

After driving through water, mud, sludge, etc., the braking effect can be delayed slightly due to moisture build-up on the discs and brake pads. Applying the brakes carefully several times will remove the moisture and restore the full braking effect.

CAUTION

- **Driving through flooded areas may severely damage vehicle components such as the engine, transmission, running gear or electrical system.**
- **Whenever driving through water, the Start-Stop system* must be switched off**
» page 188.

Note

- **Check the depth of the water before entering the flooded zone.**

- Do not stop in the water, drive in reverse, or stop the engine in any situation.
- Note that vehicles travelling in the opposite direction may splash water that could exceed the maximum permitted water height for your vehicle.
- Avoid driving through salt water (corrosion).

Driver assistance systems

Start-Stop System*

Description and operation

The Start-Stop system helps save fuel and reduce CO₂ emissions.

In Start-Stop mode, the engine will automatically switch off when the vehicle stops, when stopping at traffic lights for example. The ignition remains switched on during the stopping phase. The engine automatically switches back on when required. In this situation the light of the **START ENGINE STOP** button stays on.

As soon as the ignition is switched on, the Start-Stop function is automatically activated.

Basic requirements for the Start-Stop mode

- The driver door must be closed.
- The driver must have their seat belt fastened.
- The bonnet must be closed.
- The engine must have reached a minimum service temperature.
- The reverse gear must not be engaged.
- The vehicle must not be on a very steep slope.

WARNING


- Never switch the engine off until the vehicle is stationary. The brake servo and power steering functions will not be completely covered under warranty. More force may also be needed to turn the steering wheel or to brake. As you cannot steer and brake in the normal manner, there is a greater risk of accidents and serious injury.
- Never remove the key from the ignition if the vehicle is in motion. Otherwise, the steering could lock making it impossible to steer the vehicle.
- To avoid injury, make sure that the Start-Stop system is switched off when working in the engine compartment » page 190.

CAUTION

The Start-Stop system must always be switched off when driving through flooded areas » page 190.

Stopping/Starting the engine

Vehicles with a manual gearbox

- When the vehicle is stopped, put it into neutral and release the clutch pedal. The engine will switch off. The warning lamp  will appear on the instrument panel display.

- When the clutch pedal is pressed the engine will start up again. The warning lamp will switch off.

Vehicles with an automatic gearbox

- Use the foot brake to bring the vehicle to a stop and keep the brake pedal pressed down with your foot. The engine will switch off. The warning lamp (A) will appear in the display.
- When you take your foot off the brake pedal the engine will start up again. The warning lamp will switch off.

Additional information related to the automatic gearbox

The engine stops when the selector lever is in the positions P, D, N and S, in addition to when in manual mode. With the selector lever in position P, the engine will also remain switched off when you take your foot off the brake pedal. In order to start the engine up again the accelerator must be pressed, or another gear engaged or the brake released.

If the selector lever is placed in position R during the stopping phase, the engine will start up again.

Change from position D to P to prevent the engine from accidentally starting when changing and passing by position R.

Note

- You can control whether the engine should switch off or not by reducing or increasing the brake force applied. While the vehicle remains stopped, the engine will not stop if the brake pedal is slightly pressed, in traffic jams with frequent stopping and starting for example. As soon as strong pressure is applied to the brake pedal, the engine will stop.
- In vehicles with manual gearbox, during the stopping phases the brake pedal must remain depressed to prevent the vehicle from moving.
- If the engine “stalls” in vehicles with manual gearbox, it can be directly started up again by immediately pressing the clutch pedal.


General notes



The system can interrupt the Start-Stop mode frequently for different reasons.

The engine does not switch off

Before the stopping phase, the system verifies whether certain conditions are met. The engine **does not** switch off, in the following situations for example:


- The engine has not yet reached the minimum required temperature for the Start-Stop mode.

- The interior temperature selected for the air conditioner has not yet been reached.
- The interior temperature is very high/low.
- Defrost function button activated
»  page 42.
- The parking aid* is switched on.
- The battery is very low.
- The steering wheel is overly turned or is being turned.
- If there is a danger of misting.
- After engaging reverse gear.
- In case of a very steep gradient.

The indication  is shown on the instrument panel display, and in addition, the driver information system* shows, START  STOP.

The engine starts by itself

During a stopping phase the normal Start-Stop mode can be interrupted in the following situations: The engine restarts by itself without involvement from the driver.

- The interior temperature differs from the value selected on the air conditioner.
- Defrost function button activated
»  page 42.
- The brake has been pressed several times consecutively.
- The battery is too low.
- High power consumption.

Note

In vehicles with an automatic gearbox, if the selector lever is placed in position D, N or S after engaging reverse gear, the vehicle must be driven at a speed faster than 10 km/h (6 mph) for the system to return to conditions in which the engine can be stopped.

Manually switching on/off the Start-Stop system

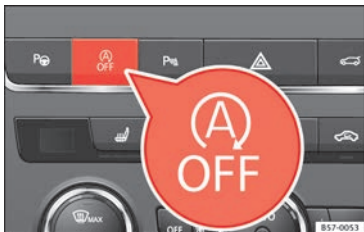


Fig. 169 Centre console: Start-Stop system button

If you do not wish to use the system, you can switch it off manually.

- To manually switch on/off the Start-Stop system, press the button . The button symbol remains lit up yellow when the system is switched off.

Note

The system is automatically switched on each time the engine is deliberately stopped during a stopping phase. The engine will start automatically.

Driver messages on the instrument panel display

Start-Stop system deactivated. Start the engine manually

This driver message is displayed when certain conditions are not met during the stopping phase and the Start-Stop system **cannot** restart the engine. The engine must be started manually.

Start-Stop system: Fault! Function not available

There is a fault in the Start-Stop system. Take the vehicle to a workshop to have the fault repaired.

Hill Descent Control (HDC)

Description and operation

✓ Valid for vehicles: 4Drive

Hill Descent Control limits the speed on steep descents by automatically braking all four

wheels, both when moving forward and in reverse. As the anti-lock brake system remains active, it prevents the wheels from locking. In vehicles with manual transmission, the Hill Descent Control adapts the theoretical speed without slowing the engine below its idling speed.

After starting the descent of a slope below 30 km/h (18 mph), speed is limited to a minimum of 2 km/h (1 mph) and a maximum of 30 km/h (18 mph). When appropriate, the driver may increase or decrease the speed within the limit by pressing the accelerator or the brake. At this point the function is interrupted and, if necessary, it is then reactivated.


Even so, it is imperative that the surface guarantees sufficient adhesion. For this reason, the Hill Descent Control **will not** fulfil its function when, for example, descending a slope with a frozen or slippery surface.

Hill Descent Control is available when the dash panel display shows the message .


Hill Descent Control automatically intervenes if the following conditions are met:

- The vehicle engine is running.
- The **Offroad** driving profile has been selected **»» page 225**. Driving at a speed below 30 km/h (18 mph) (the message is shown on the dash panel display).

- The slope of the descent is at least 10% when driving forward and 9% when driving in reverse.
- The brake and the accelerator are not pressed.

Hill Descent Control is deactivated on pressing the brake and the accelerator or if the slope is below 5%. The function may be disconnected manually in the Easy Connect system by pressing the **CAR** button and the **HDC** function button »»  **Fig. 41**.

Control lamps

»»  in Warning and control lamps on page 107.

 It lights up white


Hill Descent Control is active.

 It lights up grey

Hill Descent Control is not active. The system is switched on, but is not adjusting.

Some warning and control lamps will light up briefly when the ignition is switched on to check certain functions. They will switch off after a few seconds.

WARNING

Observe the safety warnings »»  in Warning and control lamps on page 107.

WARNING

Always be ready to brake. Otherwise, an accident could occur and cause injury.


- Hill Descent Control is only an auxiliary system that in some situations may not sufficiently brake the vehicle when going down a slope.
- The speed of the vehicle may increase despite the intervention of Hill Descent Control.

Auto Hold Function

Description and operation



Fig. 170 In the lower part of the centre console: Auto Hold function button.


The control light of the  »» **Fig. 170** button remains on when the Auto Hold function is connected.

Once connected, the Auto Hold function assists the driver in keeping the vehicle stationary at repeated intervals or for a certain period of time with the engine running, for example, when going up a slope, when stopped at traffic lights or in heavy traffic with intermittent stops.

When connected, the Auto Hold function automatically prevents the vehicle from rolling when stationary without pressing the brake pedal.

After detecting that the vehicle is stationary and the brake pedal has been released, the Auto Hold function holds the vehicle. The driver can lift their foot off the brake pedal.

When the driver touches the accelerator pedal or accelerates slightly to continue driving, the Auto Hold function releases the brake. The vehicle moves according to the slope of the road.



If the vehicle is stationary and one of the conditions required by the Auto Hold function is impaired, it disconnects itself and the button's control light goes out »» **Fig. 170**. The electronic parking brake connects automatically, if necessary, to park the vehicle safely »» .

Conditions for keeping the vehicle stationary with the Auto Hold function


- The driver door must be closed.
- The driver's seat belt must be fastened. »»

- The engine is running.

Switching the Auto Hold function on and off


Press the button  . The control lamp on the button goes out when the Auto Hold function is switched off.


Automatically engaging and disengaging the Auto Hold function

If the Auto Hold function was switched on with the  button before disengaging the ignition, the function will remain on after the ignition is re-engaged.

If the Auto Hold function was not switched on, it will automatically remain off next time the ignition is engaged.

The Auto Hold function is automatically switched on if the following conditions are met:

All conditions must be met at the same time » 		
	Manual gearbox	Automatic gearbox
1.	The vehicle is kept stationary with the brake pedal on a flat surface or on a slope.	
2.	The engine rotates "correctly".	

All conditions must be met at the same time » 		
	Manual gearbox	Automatic gearbox
	Upon pressing the clutch and accelerating at the same time, the brake releases gradually.	Upon accelerating, the brake releases gradually.

The Auto Hold function is automatically turned off if the following conditions are met:

	Manual gearbox	Automatic gearbox
1.	If any of the conditions mentioned on » page 191, Conditions for keeping the vehicle stationary with the Auto Hold function are no longer met.	
2.	If the engine is running irregularly or an anomaly is detected.	
3.	If the engine is turned off or stalls.	If the engine is switched off.
4.	The clutch and the accelerator are pressed at the same time.	If the accelerator is pressed.
5.		If any of the tyres has only minimal contact with the ground, e.g. in the case of axle articulation.

WARNING

The smart technology incorporated into the Auto Hold function cannot defy the laws of physics; it only works within the limits of the system. The greater convenience provided by the Auto Hold function should never tempt you to take any risk that may compromise safety.

- Never leave the vehicle running and with the Auto Hold function switched on.
- The Auto Hold function cannot always keep the vehicle stationary uphill or downhill or stop it sufficiently, for example, on slippery or frozen surfaces.

Note

Before entering a car wash, always switch off the Auto Hold function, because if the electronic parking brake is automatically connected, it may cause damage.

Cruise control system (CCS)*

Operation



Fig. 171 Instrument panel display: CCS status indications

Read the additional information carefully

» page 36

The cruise control system (CCS) is able to maintain the set speed from 20 km/h (15 mph).

The CSS only reduces vehicle speed by ceasing to accelerate, not by actively braking the vehicle » .

Control lamp

When the warning lamp is lit, cruise control is active.

Several warning and control lamps light up for a few seconds when the ignition is switched on, signalling that the function is being verified. They will switch off after a few seconds.

Displayed on the CCS screen

Status **Fig. 171**:

- A** CCS temporarily switched off. The set speed is displayed in small or darkened figures.
- B** System error. Contact a specialised workshop.
- C** CCS switched on. The speed memory is empty.
- D** The CCS is switched on. The set speed is displayed in large figures.

WARNING

Use of the cruise control could cause accidents and severe injuries if it is not possible to drive at a constant speed maintaining the safety distance.

- Do not use the cruise control in heavy traffic, if the distance from the vehicle in front is insufficient, on steep roads, with several bends or in slippery circumstances (snow, ice, rain or loose gravel), or on flooded roads.
- Never use the CCS when driving off-road or on unpaved roads.

- Always adapt your speed and the distance to the vehicles ahead in line with visibility, weather conditions, the condition of the road and the traffic situation.
- To avoid unexpected operation of the cruise control system, turn it off every time you finish using it.
- It is dangerous to use a set speed which is too high for the prevailing road, traffic or weather conditions.
- When travelling down hills, the CCS cannot maintain a constant speed. The vehicle tends to accelerate under its own weight. Select a lower gear or use the foot brake to slow the vehicle.

WARNING

Observe the safety warnings » in Warning and control lamps on page 107.

Operating the cruise control system*

Read the additional information carefully

» page 36

The value indicated in the table in brackets (in mph, miles per hour) only refers to instrument panels with indications in miles. »

Changing gear in CCS mode

The CCS decelerates as soon as the clutch pedal is pressed, intervening again automatically after a gear is engaged.

Travelling down hills with the CCS

When travelling down hills the CCS cannot maintain a constant speed. Slow the vehicle down using the brake pedal and reduce gears if required.

Automatic off

The cruise control system (CCS) is switched off automatically or temporarily:

- If the system detects a fault that could affect the working order of the CCS.
- If you press and maintain the accelerator pedal for a certain time, driving faster than the stored speed.
- If the dynamic driving control systems intervene (e.g. ASR or ESC).
- If the airbag is triggered.

Speed limiter

Display messages and warning and control lamp



Fig. 172 On the instrument panel display: messages on the status of the speed limiter.

The speed limiter helps avoid exceeding a speed individually programmed upwards of approximately 30 km/h (19 mph) driving in forwards gears »» ⚠

Display messages on the speed limiter

Status »» **Fig. 172:**

- A** The speed limiter is active. The last speed set is displayed in large figures.
- B** The speed limiter is not active. The last speed set is displayed in small or darkened figures.
- C** The speed limiter is switched off. The total mileage is displayed.

Warning and control lamp



Lights up green

The speed limiter is switched on and active.



Flashes green

The speed set by the speed limiter has been exceeded.



Lights up

The adaptive cruise control (ACC) and the speed limiter are active.

Some warning and control lamps will light up briefly when the ignition is switched on to check certain functions. They will switch off after a few seconds.

⚠ WARNING

After use, always switch off the speed limiter to prevent the speed being regulated against your wishes.

- The speed limiter does not relieve the driver of their responsibility to drive at the appropriate speed. Do not drive at high speed if not necessary.
- Using the speed limiter with adverse weather conditions is dangerous and can cause serious accidents, e.g. because of aquaplaning, snow, ice, leaves, etc. You should use the speed limiter function only when traffic, road and weather conditions allow it to be used safely.

- When driving downhill, the speed limiter cannot limit the vehicle speed. Its speed will increase due to its own weight. In this case, select a lower gear or use the foot brake to slow the vehicle.

⚠ WARNING

Observe the safety warnings » ⚠ in Warning and control lamps on page 107.

i Note

- Different versions of the instrument panel are available and therefore the versions and instructions on the display may vary.
- If when switching the ignition off, the cruise control system (CCS), the adaptive cruise control (ACC) or the speed limiter were switched on, then the cruise control system

or the adaptive cruise control will automatically switch themselves on when the ignition is back on. However, no speed will be stored. The last set speed of the speed limiter will be stored.

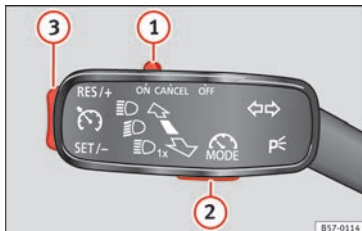
Operate the speed limiter


Fig. 173 On the left of the steering column: control and buttons to operate the speed limiter.

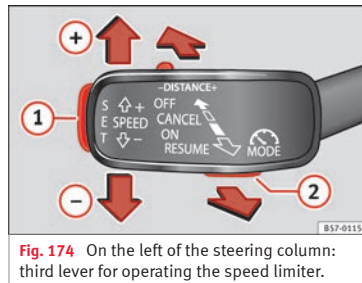


Fig. 174 On the left of the steering column: third lever for operating the speed limiter.

Function	Position of the turn signal lever » Fig. 173 or the third lever » Fig. 174	Effect
Switching on the speed limiter	Press button ② on the turn signal lever or button ② on the third lever	The system switches on. The last set speed of the speed limiter is stored. It does not take effect yet. »

Operation

Function	Position of the turn signal lever » Fig. 173 or the third lever » Fig. 174	Effect
Switching between the speed limiter and cruise control (CCS) or the adaptive cruise control (ACC) (with the speed limiter switched on)	Press button ② on the turn signal lever or button ② on the third lever	It switches between the speed limiter and the CCS or the adaptive cruise control (ACC).
Switching on the speed limiter	Press button ③ on the turn signal lever or button SET ① on the third lever.	The current speed is stored as the maximum speed and the limiter is switched on.
Temporarily switching off the speed limiter limitation	Place control ① of the turn signal lever in position CANCEL or move the third lever into position CANCEL.	The limiter is switched off temporarily. The speed will be stored.
Temporarily switch off the speed limiter limitation pressing down the accelerator (kick-down)	Press down on the accelerator beyond the point of resistance (e.g. to overtake). Surpassing the set speed switches the speed limiter off temporarily.	The limiter is switched off temporarily. The speed will be stored. The limiter is reactivated automatically after returning to less than the set speed.
Switching the speed limiter on again	Press button ③ on the turn signal lever or move the third lever into position RESUME.	The speed is limited to the set speed as soon as the speed you are driving at is lower than the speed set as maximum.
Increasing the set speed of the limiter	Briefly press button ③ on the turn signal lever in the area RES/+ or press SET ① on the third lever to increase the speed in small increments of 1 km/h (1 mph) and set it.	The speed is limited to the set value
	Press SPEED+ on the third lever to increase the speed in increments of 10 km/h (5 mph) and set it.	
	Hold down button ③ on the turn signal lever in the area RES/+ or hold down SPEED+ to increase continuously in increments of 10 km/h (5 mph) and set it.	
Reducing the set speed of the limiter	Briefly press button ③ on the turn signal lever in the area SET/- or move the third lever into position RESUME to reduce the speed in small increments of 1 km/h (1 mph) and set it.	The speed is limited to the set value
	Press SPEED- on the third lever to reduce the speed in increments of 10 km/h (5 mph) and set it.	
	Hold down button ③ on the turn signal lever in the area SET/- or hold down SPEED- to increase continuously in increments of 10 km/h (5 mph) and set it.	

Function	Position of the turn signal lever » Fig. 173 or the third lever » Fig. 174	Effect
Switching off the speed limiter	Move control ① of the turn signal lever into position OFF or the third lever into position OFF .	The system switches off. The set speed will be stored.

The values shown in the table in brackets, in mph, are displayed only in instrument panels with indications in miles.

Going down slopes with the speed limiter

If the set speed of the speed limiter is exceeded while driving downhill, soon afterwards the warning and control lamps flash ⚠ » page 194 and an acoustic warning may sound. In this case, use the foot brake to slow the vehicle or, if necessary, select a lower gear.

Switching off temporarily

If you wish to temporarily switch off the speed limiter, e.g. to overtake, move control » Fig. 173 ① of the turn signal lever into position **CANCEL** or the third lever into pressure point **CANCEL** or press button ② on any lever.

After overtaking, the speed limiter can be switched on with the previously set speed by pressing button ③ on the turn signal lever in the area **RES/+** or by moving the third lever into pressure point **RESUME**.

Switch the speed limiter off temporarily by pressing down the accelerator (kick-down)

If the accelerator is pressed right down (kick-down) and the set speed is exceeded because driver wishes to do so, the limiter is temporarily disabled.

To confirm it being switched off an acoustic signal sound once. While the limiter is off, the warning and control lamp ⚠ flashes.

When the accelerator is no longer pressed down and the speed is reduced below the set value, the limiter switches on again. The control lamp ⚠ will light up and remain lit.

Automatic off

The speed limiter is automatically switched off:

- If the system detects a fault that could negatively affect the working order of the limiter.
- If the airbag is triggered.

⚠ CAUTION

For automatic switching off due to system failures, for security reasons, the limiter is only completely switched off when the driver

stops pressing the accelerator at some point or consciously switches off the system.

Adaptive Cruise Control ACC*

Introduction

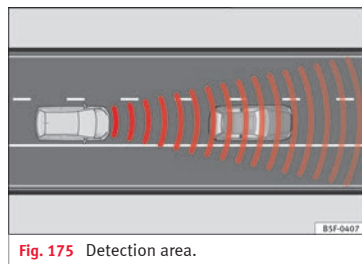


Fig. 175 Detection area.

» table on page 2

The adaptive cruise control (ACC) is an extension of the normal cruise control system (CCS) » ⚠.

The ACC function allows the driver to establish a cruise speed of between 30 and 210 »

km/h (18 and 150 mph), as well as the temporary distance required with regard to the vehicle in front. The ACC function will adapt the vehicle's cruise speed at all times, maintaining a safe distance with the vehicle in front.

The ACC function is based on a radar sensor that can measure the distance to the vehicles in front.

If the vehicle is equipped with automatic gearbox, the ACC can brake the vehicle **until it stops completely** if a vehicle in front of it stops.

Driver intervention prompt

During driving, the ACC is subject to certain limitations inherent in the system. In other words, in certain circumstances the driver will have to adjust speed him or herself, as well as the distance from other vehicles.

In this case, the instrument panel screen *will warn you to intervene* by applying the brake and a warning tone will be heard
»» page 199.

WARNING

The intelligent technology in the ACC cannot overcome the system's inherent limitations or change the laws of physics. If used negligently or involuntarily, it may cause serious accidents and injuries. The system is not a replacement for driver awareness.

- Adapt your speed and safe distance to the vehicle in front of you at all times to suit visibility, weather, road and traffic conditions.
- Do not use the ACC when visibility is bad, on steep roads, with several bends or in slippery circumstances such as snow, ice, rain or loose gravel, or on flooded roads.
- Never use the ACC when driving off-road or on unpaved roads. The ACC has been designed for use on paved roads only.
- The ACC does not react on approaching a fixed obstacle, such as the tail of a traffic jam, a damaged vehicle or a vehicle stopped at the traffic lights.
- The ACC only reacts to people if a pedestrian monitoring system is available. In addition, the system does not react to animals or vehicles crossing your path or approaching head-on down the same lane.
- If the ACC does not reduce speed sufficiently, brake the vehicle immediately by applying the pedal.
- If you are driving using the spare wheel, the ACC system could automatically switch off during the journey. Switch off the system when starting off.
- If the vehicle continues to move involuntarily after a driver intervention prompt, brake the vehicle by applying the pedal.
- If the dash panel displays a *driver intervention prompt*, adjust the distance yourself.
- The driver should be ready to accelerate or brake by him/herself at all times.

CAUTION

If you have the sensation that the radar sensor is damaged, disconnect the ACC. This will avoid possible damage. If this occurs have it adjusted.

- Repairs to the radar sensor require specialist knowledge and special tools. SEAT recommends visiting a SEAT dealership for this purpose.

Note

- If the ACC system does not work as described in this chapter, do not use it until it has been checked by a specialised workshop. SEAT recommends visiting a SEAT dealership for this purpose.
- Maximum speed with the ACC activated is limited to 210 km/h (150 mph).
- When the ACC is switched on, strange noises may be heard during automatic braking cause by the braking system.

Indications on the display, warning and control lamps

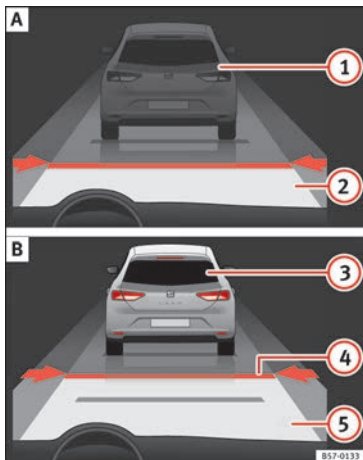


Fig. 176 On the instrument panel display: (A) ACC temporarily inactive, vehicle detected in front, temporary distance adjusted. (B) ACC active, vehicle detected in front, temporary distance adjusted.


Status display

Indications on the display » **Fig. 176:**

- 1 Vehicle in front, the ACC is inactive.

- 2 Distance margin selected, the ACC is inactive.
- 3 Vehicle detected in front. The ACC is active.
- 4 Adjustment of the temporary distance from the vehicle in front with a programmed speed.
- 5 Temporary distance adjustment from the vehicle in front with a programmed speed.

Warning and control lamps

»  in Warning and control lamps on page 107.



The speed reduction by the ACC to maintain the distance from the vehicle in front is not sufficient.

Brake! apply the foot brake! Driver intervention prompt.



The ACC is not currently available.^{a)}

With the vehicle stationary, switch off the engine and start it up again. Check the SEAT badge area on the front » **Fig. 177** (in case it is dirty or icy or it has been hit). If it is still unavailable, refer to a specialised workshop to have the system inspected.

^{a)} The symbol on the instrument panels with colour display is in colour.



The ACC is active.

No vehicle is detected in front. The programmed speed remains constant.



If the symbol is white: the ACC is active.

A vehicle in front has been detected. The ACC adjusts speed and distance from the vehicle in front.



If the symbol is grey: the ACC is not active.

The system is switched on, but is not adjusting.



The ACC and the speed limiter are active.



The ACC and the cruise control system (CCS) are active.



It lights up green

The ACC is active.

Some warning and control lamps will light up briefly when the ignition is switched on to check certain functions. They will switch off after a few seconds.

⚠ WARNING

Observe the safety warnings » **⚠** in Warning and control lamps on page 107.

i Note

When the ACC is connected, the indications on the instrument panel screen may be concealed by warnings from other functions, such as an incoming call.

Radar sensor



Fig. 177 On the front behind the SEAT badge: radar sensor.

On the front behind the SEAT badge, a radar sensor has been installed to capture the traffic situation » **Fig. 177**. This sensor can detect vehicles in front up to a distance of approximately 120 m.

The radar sensor's visibility may be impaired by dirt, mud or snow, or by environmental influences such as rain or mist. In this case the adaptive cruise control (ACC) does not work. The instrument panel displays the following message: **ACC: No sensor vision!** If necessary, clean the SEAT badge area » **!**

When the radar sensor begins to operate properly again, the ACC will automatically be available again. The message on the instrument panel screen will switch off and the ACC will be reactivated again.

ACC operation may be affected by a strong radar reverse reflection. This may occur, for example, in a closed car park or due to the presence of metallic objects (e.g. rails on the road or sheets used in road works).

The area in front of and around the radar sensor should not be covered with adhesives, additional or similar headlights, as this may negatively affect ACC operation.

If structural modifications are made to the vehicle, for example, if the suspension is lowered or the front spoiler is modified, ACC operation may be affected. So structural modifications should only be made by specialised workshops. SEAT recommends visiting a SEAT dealership for this purpose.

If work is done incorrectly on the front of the vehicle, the radar sensor could be damaged or lose its settings, and ACC operation may be affected. So repair work should only be

made by specialised workshops. SEAT recommends visiting a SEAT dealership for this purpose.

ⓘ CAUTION

If you have the sensation that the radar sensor is damaged or has lost its settings, disconnect the ACC. This will avoid possible damage. If this occurs have it adjusted.

- The sensor may become damaged or lose its settings when knocked, for example, during a parking manoeuvre. This may compromise the system's efficacy or disconnect it.
- Repairs to the radar sensor require specialist knowledge and special tools. SEAT recommends visiting a SEAT dealership for this purpose.
- Clean away the snow with a brush and the ice preferably with a solvent-free de-icer spray.

Operating the Adaptive Cruise Control ACC

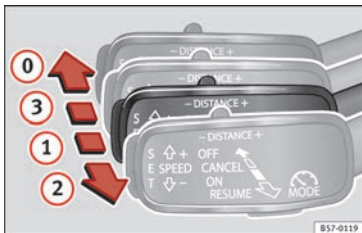


Fig. 178 On the left of the steering column: third lever for operating the Adaptive Cruise Control.

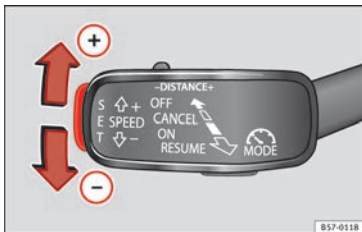



Fig. 179 On the left of the steering column: third lever for operating the Adaptive Cruise Control.

When the Adaptive Cruise Control (ACC) is connected, the green control lamp  will light up on the instrument panel, and the programmed speed and ACC status will be displayed **» Fig. 176.**

Conditions for the adaptive cruise control to be activated

- The selector lever must be at the **D** or **S** position or in the tiptronic selection track. In manual gearbox any forward gear must be engaged, except the 1st gear.
- In vehicles with manual gearbox, if there is no programmed speed, drive at least at 30 km/h (18 mph).

Speed control

When the ACC is connected, speed can be programmed and adjusted. The programmed speed must be different from the speed at which the vehicle travels if the distance is being adjusted at the time.

What functions can be operated?

If you activate the ACC the current speed can be programmed as the “control speed”.

During driving, control can be operated at any time and the speed also modified.

The following settings can also be adjusted:

- Distance.
- Driving Programme.
- Driving style.

Activating/Deactivating

Any speed¹⁾ between 30 and 210 km/h (19 and 150 mph) can be adjusted.

Activating the ACC

- Pull the lever to position **1** **» Fig. 178.** **ACC standby** will be shown on the instrument panel display.

Programme speed and activate control

- Press the **(SET)** **» Fig. 179** button to programme current speed.
- Automatic gearbox: apply the brake pedal to activate control with the vehicle stationary.

Deactivating the ACC

- Move the lever to position **0** until it engages. The text **ACC: off** appears.

Altering speed

- To increase or reduce speed step by step, press the lever up/down briefly **» Fig. 179.** **»**

¹⁾ Different speed limits apply in each country and depend on the unit indicated on the speedometer.

Any modification to the programmed speed is shown on the bottom left part of the instrument panel display.

Adjusting distance level

The distance according to speed with regard to the vehicle in front can be controlled on the Easy Connect system on 5 levels

»  page 26.

In wet road conditions, you should always set a larger distance with regard to the vehicle in front than when driving in dry conditions.

The following distances can be preselected:

- Very short
- Short
- Media
- Long
- Very long

In the Easy Connect system the distance that must be set when connecting the ACC may be adjusted using the **CAR** button and the **Setup** and **Driver assistance** function buttons

»  page 26.


Adjusting the driving programme

In vehicles with driving profile selection (SEAT Drive Profile), the profile selected can influence acceleration behaviour

» page 225.

The following driving programmes items can be selected:

- Normal
- Sport
- Eco
- Convenience

In vehicles without the driving profile selection function, acceleration behaviour can be influenced by selecting a driving programme on the Easy Connect system using the **CAR** button and the **Setup** and **Driver assistance** function buttons »  page 26.

The following conditions may lead the ACC not to react:

- If the accelerator is pressed.
- If there is no gear engaged.
- If the ESC is controlling.
- If the driver is not wearing his/her seat belt.
- If several brake lights of the vehicle or electrically connected trailer are damaged.
- If the vehicle is reversing.
- Driving faster than 210 km/h (150 mph).

WARNING

There is a danger of rear collision when the minimum distance to the vehicle in front is exceeded and the speed difference between

both vehicles is so great that a speed reduction by the ACC will not suffice. In this case the brake pedal should be applied immediately.

- The ACC may not be able to detect all situations properly.
- “Stepping” on the accelerator may cause the ACC not to intervene in braking. Driver braking will have priority over intervention by the speed control or adaptive cruise control.
- Always be ready to use the brakes!
- Observe country-specific provisions governing obligatory minimum distances between vehicles.

Note

- The programmed speed is erased once the ignition or the ACC are switched off.
- When the traction control system (ASR) is deactivated during acceleration or else the ESC is activated in Sport* Mode (» page 108), the ACC switches off automatically.
- In vehicles with the Start-Stop system, the engine switches off automatically during the ACC stopping phase and restarts automatically to begin driving.

Vehicles with an automatic gearbox

If the vehicle is equipped with automatic gearbox, the ACC can brake the vehicle until

it stops completely if a vehicle in front of it stops.

The ACC will still be available for a few seconds. The vehicle will restart by itself if the vehicle in front moves (traffic jam assistant).

Disconnection criteria

The ACC will switch off if the driver applies the brake pedal or the driver's door is opened.

Restarting the vehicle with the ACC manually

The ACC can be activated again by moving the lever to position ② » Fig. 180.

ⓘ CAUTION

- If your vehicle with ACC does not start up as expected, you can drive off by briefly stepping on the accelerator.
- The Start-Stop system usually acts if you are driving with ACC.

Interrupting control

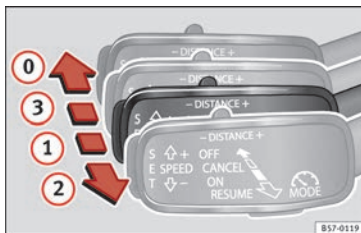


Fig. 180 On the left of the steering column: third lever for operating the Adaptive Cruise Control.

Important: the ACC is active.

Interrupting control during driving

- Move the lever to the position ③. The **ACC standby** message is displayed to the driver. or
- Brake.
- To resume the programmed speed, turn the lever to position ②.

Interrupt speed control with the vehicle stationary

Applies to vehicles with automatic gearbox:

- Move the lever to the position ③. The **ACC standby** message is displayed to the driver.

- To resume control, apply the brake and turn the lever to position ②.

⚠ WARNING

It is dangerous to activate control and resume the programmed speed if the road, traffic or weather conditions do not permit this. Risk of accident!

Setting the distance




Fig. 181 Control lever: setting the distance.

- To display the distance currently programmed, briefly press the rocking button » Fig. 181.
- To increase/reduce the distance one level, press the rocking button again towards the left/right. The instrument panel display modifies the distance between both vehicles.

If the vehicle approaches another vehicle detected in front of it, the ACC reduces the

speed accordingly and then controls the adjusted distance. If the vehicle detected in front accelerates, the adaptive cruise control will also accelerate up to the target speed programmed at most.

The greater the speed, the greater the distance in metres should be **»** . We recommend the setting **Distance 3**.

WARNING

With regard to distance setting, the driver is responsible for observing country-specific legislation.

Driver messages

ACC not available

The system can no longer continue to guarantee safe vehicle detection and will be deactivated. The sensor has lost its setting or is damaged. Take the vehicle to a specialised workshop and have the fault repaired.

ACC: currently not available. No sensor vision

ACC and Front Assist: currently not available. No sensor vision

This message will be displayed to the driver if the radar sensor's vision is impaired due, for

example, to leaves, snow, heavy fog or dirt. Clean the SEAT badge **»** **Fig. 177**.

ACC: currently not available. Gradient too steep

The maximum road slope has been exceeded, hence safe ACC operation cannot be guaranteed. The ACC cannot be switched on.

ACC: only available in D, S or M

Select the D/S or M position on the selector lever.

ACC: parking brake applied

The ACC is deactivated if the parking brake is applied. The ACC is available once again after the parking brake is released.

ACC: currently not available. Intervention of stability control

The message for the driver is displayed when the electronic stability control (ESC) intervenes. In this case, the ACC is automatically switched off.

ACC: Take action!

The message for the driver is displayed if, when the vehicle starts up on a hill with a mild slope, the vehicle rolls back even although the ACC is activated. Apply the brake to stop the vehicle from moving/colliding with another vehicle.

ACC: speed limit

The message for the driver is displayed if, in vehicles with manual gearbox, the current speed is too low for the ACC mode.

The speed to be stored must be at least 30 km/h (18 mph). The speed limiter switches off if the speed falls below 20 km/h (12 mph).

ACC: available as of the 2nd gear

The ACC is operational as of the 2nd gear (manual gearbox).

ACC: engine speed

The message for the driver is displayed if, when the ACC accelerates or brakes, the driver does not shift up or down a gear in time, which means exceeding or not reaching the permissible engine speed. The ACC switches itself off. A buzzer warning is heard.

ACC: clutch pressed

Vehicles with a manual gearbox: pressing the clutch pedal for longer abandons control mode.

Door open

Vehicles with automatic gearbox: the ACC cannot be activated with the vehicle stationary and the door open.

Deactivating the Adaptive Cruise Control ACC temporarily in certain situations

In the following situations the Adaptive Cruise Control (ACC) should be deactivated due to the system's limitations » **⚠**:

- When changing lanes, on tight bends and roundabouts, in acceleration and deceleration lanes on motorways or in sections with road works to prevent involuntary acceleration to reach the programmed speed.
- When going through a tunnel, as operation could be affected.
- On roads with several lanes, when other vehicles are driving more slowly in the overtaking lane. In this case, slower vehicles will be overtaken on the right.
- In case of heavy rain, snow or spray, as the vehicle in front might not be detected properly or, in certain circumstances, might not be detected at all.

⚠ WARNING

If the ACC does not switch off in the situations described, serious accidents and injuries may occur.

- Always switch off the ACC in critical situations.

i Note

If you do not switch off the ACC in the aforementioned situations, you may commit a legal offence.

Special driving situations

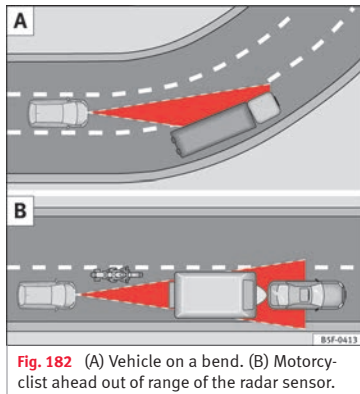


Fig. 182 (A) Vehicle on a bend. (B) Motorcyclist ahead out of range of the radar sensor.

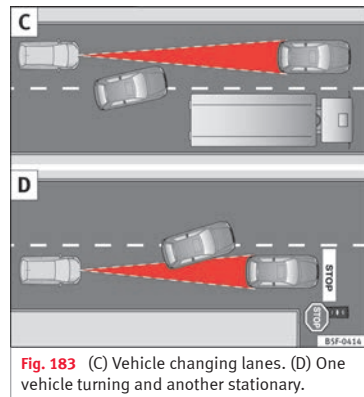


Fig. 183 (C) Vehicle changing lanes. (D) One vehicle turning and another stationary.

The adaptive cruise control (ACC) has certain physical limitations inherent in the system. For example, certain reactions of the ACC, in certain circumstances, may be unexpected or come late from the driver's point of view. So pay attention in order to intervene if necessary.

For example, the following traffic situations call for the utmost attention:

Starting driving after a stopping phase (only vehicles with automatic gearbox)

After a stopping phase the ACC may begin driving automatically when the vehicle in front drives off.

»

Overtaking

When the turn signal lights up before the vehicle begins an overtaking manoeuvre, the ACC accelerates the vehicle automatically and thus reduces the distance from the vehicle in front.

When the vehicle enters the overtaking lane, if the ACC does not detect another vehicle in front, it accelerates until it reaches the programmed speed and maintains it.

System acceleration can be interrupted at any time by pressing the brake or moving the third lever backwards » page 201.

Driving through a bend

On entering or exiting bends, the radar sensor may no longer determine the vehicle in front or react to a vehicle in the adjacent lane » Fig. 182 A. In these situations the vehicle may brake unnecessarily or fail to react to react to the vehicle in front. In this case, the driver has to intervene by accelerating or interrupting the braking process by applying the brake or pushing the third lever backwards » page 201.

Driving in tunnels

When driving through tunnels the radar sensor may be limited. Switch off the ACC in tunnels.

Narrow or misaligned vehicles

The radar sensor can only detect narrow or misaligned vehicles when they are within range » Fig. 182 B. This applies particularly to narrow vehicles such as motorbikes. In these cases, you should brake as necessary.

Vehicles with special loads and accessories

Special loads and accessories of other vehicles that jut out over the sides, backwards or over the top may be out of the ACC's range.

Switch off the ACC when driving behind vehicles with special loads and accessories or when overtaking them. In these cases, you should brake as necessary.

Other vehicles changing lanes

Vehicles changing lanes a short distance away from your own can only be detected when they are within range of the sensors. Consequently, the ACC will take longer to react » Fig. 183 C. In these cases, you should brake as necessary.

Stationary vehicles

The ACC does not detect stationary objects while driving, such as traffic tails or damaged vehicles.

If a vehicle detected by the ACC turns or moves over and there is a stationary vehicle in front of it, the ACC will not react to it

» Fig. 183 D. In these cases, you should brake as necessary.

Vehicles driving in the opposite direction and vehicles crossing your path

The ACC does not react to vehicles approaching from the opposite direction or vehicles crossing your path.

Metal objects

Metal objects, e.g. rails on the road or sheets used in road works, can confuse the radar sensor and cause the ACC to react wrongly.

Factors that may affect how the radar sensor operates

If laser sensor operation is impaired, due to heavy rain, spray, snow or mud, the ACC is deactivated temporarily. The relevant text message will appear in the dash panel display. If necessary clean the SEAT badge » Fig. 177.

When the radar sensor begins to operate properly again, the ACC will automatically be available again. The message on the instrument panel screen will switch off and the ACC will be reactivated again.

ACC operation may be affected by a strong radar reverse reflection, for example in a closed car park.

Trailer mode

When driving with trailer the ACC controls less dynamically.

Overheated brakes

If the brakes overheat, for example after abrupt braking or in long and steep slopes, the ACC may be deactivated temporarily. The relevant text message will appear in the dash panel display. In this case, adaptive cruise control cannot be activated.

Adaptive cruise control can be reactivated once brake temperature has cooled sufficiently. The message will disappear from the instrument panel display. If the message **ACC not available** remains on for quite a long time it means that there is a fault. Contact a specialised workshop. SEAT recommends visiting a SEAT dealership.

WARNING

If the message ACC ready to start appears on the instrument panel display and the vehicle in front starts up, the vehicle will start up automatically. In this case the radar sensor may not detect obstacles on the road. This could cause an accident and serious injuries.

- **Before driving off, check that the road is clear. If necessary, apply the brake.**

Front Assist system including City emergency braking and pedestrian monitoring*

Introduction

The Front Assist system including City emergency braking and pedestrian monitoring can help avoid collisions.

The Front Assist system may warn the driver, within the constraints of the system, of impending collisions, prepare the vehicle for emergency braking in case of danger, provide support during braking and apply automatic braking.

The City emergency braking and pedestrian monitoring functions are an integral part of the Front Assist system.

The Front Assist is not a replacement for driver awareness.

Distance warning

If the system detects that safety is endangered by the proximity of the vehicle in front, it may warn the driver by means of a message on the instrument panel when driving at a speed of between approximately 60 km/h (37 mph) and 250 km/h (156 mph)


»» **Fig. 184.**

The warning moment varies depending on the traffic situation and driver behaviour.

Advance warning

If the system detects a possible collision with the vehicle in front, it may warn the driver by means of an audible warning and an indication on the instrument panel when driving at a speed of between approximately 30 km/h (18 mph) and 250 km/h (156 mph)

»» **Fig. 184.**

The warning moment varies depending on the traffic situation and driver behaviour. At the same time, the vehicle will prepare for a possible emergency braking »» .

Critical warning

If the driver fails to react to the advance warning, the system may actively intervene in the brakes when driving at a speed of between approximately 30 km/h (18 mph) and 250 km/h (156 mph), generating a brief jolt to warn of the imminent collision.

Automatic braking

If the driver also fails to react to the advance warning, the system may brake the vehicle automatically, by progressively increasing braking effect driving at a speed of between approximately 4 km/h (2.5 mph) and 250 km/h (156 mph). By reducing speed in case of a possible collision, the system may contribute to reducing the consequences of an accident.

»»

Front assist

If the Front Assist notices that the driver is not braking sufficiently in case of a collision hazard, the system can increase braking effect and thus avert the collision when driving at a speed of between approximately 4 km/h (2.5 mph) and 250 km/h (156 mph). Front assist only acts while the brake pedal is pressed down hard.

⚠ WARNING

The intelligent technology in the Front Assist cannot change the laws of physics. The driver is always responsible for braking in time. If the Front Assist issues a warning, then, depending on the traffic circumstances, you must brake immediately or dodge the obstacle.

- Adapt your speed and safe distance to the vehicle in front of you at all times to suit visibility, weather, road and traffic conditions.
- The Front Assist alone cannot avoid accidents and serious injuries.
- In complex driving situations, the Front Assist may issue unnecessary warnings and intervene unnecessarily in braking, such as in traffic islands.
- If the operation of the Front Assist is impaired, for example, by dirt or because the radar sensor has lost its settings, the system may issue unnecessary warnings and intervene inopportunistically in the braking.

- Front Assist does not react to animals or vehicles crossing your path or approaching head-on down the same lane.
- The driver must always be ready to take over the control of the vehicle.

i Note


- When the Front Assist causes a braking, the brake pedal is "harder".
- Automatic interventions by the Front Assist on the brakes may be interrupted by pressing the clutch, accelerator or moving the wheel.
- If the Front Assist does not work as described in this chapter (e.g. in intervenes several times unnecessarily), switch it off. Have the system checked by a specialised workshop. SEAT recommends visiting a SEAT dealership.

On-screen warning lamps and messages




Fig. 184 On the instrument panel display: Warning indications.

Distance warning

If the safe distance with regard to the vehicle in front is exceeded, the relevant warning will appear on the instrument panel display .

⚠ WARNING

Observe the safety warnings »  in Warning and control lamps on page 107.

i Note

When the Front Assist is connected, the indications on the instrument panel screen may be concealed by warnings from other functions, such as an incoming call.

Radar sensor



Fig. 185 On the front behind the SEAT badge: radar sensor.

On the front behind the SEAT badge, a radar sensor has been installed to capture the traffic situation » **Fig. 185**. This sensor can detect vehicles in front up to a distance of approximately 120 m.

The radar sensor's visibility may be impaired by dirt, mud or snow, or by environmental influences such as rain or mist. In this case the Front Assist monitoring system does not work. The instrument panel displays the following message: **Front Assist: No sensor vision!** If necessary, clean the SEAT badge area » **!**.

When the radar sensor begins to operate properly again, the Front Assist will automatically be available again. The message will disappear from the instrument panel display.

Front Assist operation may be affected by a strong radar reverse reflection. This may occur, for example, in a closed car park or due to the presence of metallic objects (e.g. rails on the road or sheets used in road works).

The area in front of and around the radar sensor should not be covered with adhesives, additional or similar headlights, as this may negatively affect Front Assist operation.

If structural modifications are made to the vehicle, for example, if the suspension is lowered or the front spoiler is modified, Front Assist operation may be affected. So structural modifications should only be made by specialised workshops. SEAT recommends visiting a SEAT dealership for this purpose.

If work is done incorrectly on the front of the vehicle, the radar sensor could be damaged or lose its settings, and Front Assist operation may be affected. So repair work should only be made by specialised workshops. SEAT recommends visiting a SEAT dealership for this purpose.

ⓘ CAUTION

If you have the sensation that the radar sensor is damaged or has lost its settings, disconnect the Front Assist. This will avoid possible damage. If this occurs have it adjusted.

- **The sensor may become damaged or lose its settings when knocked, for example, dur-**

ing a parking manoeuvre. This may compromise the system's efficacy or disconnect it.

- **Repairs to the radar sensor require special knowledge and special tools. SEAT recommends visiting a SEAT dealership for this purpose.**
- **Clean away the snow with a brush and the ice preferably with a solvent-free de-icer spray.**

Operating the Front Assist



Fig. 186 On the instrument panel display: Front Assist switched off message.



The Front Assist monitoring system is active whenever the ignition is switched on.


When the Front Assist is switched off, so too are the advance warning function (pre warning) and the distance warning. »

SEAT recommends leaving the Front Assist always switched on. Exceptions »» page 210, **Temporarily switching the Front Assist system off in the following situations.**


Switching the Front Assist monitoring system on and off

With the ignition switched on, the Front Assist can be switched on and off as follows:

- Select the corresponding menu option using the button for the driver assistance systems »»  page 30.
- **OR:** switch the system on and off in Easy Connect using the **CAR** button and the **Setup** and **(Driver assistance)** function buttons »»  page 26.

When the Front Assist monitoring system is switched off, the instrument panel will inform that it has been switched off with the following indicator  »» **Fig. 186.**

Switching the advance warning function on and off

The advance warning function may be switched on and off in the Easy Connect system using the **CAR** button and the **Setup** and **(Driver assistance)** function buttons »»  page 26.

The system will store the setting for the next time the ignition is switched on.


SEAT recommends keeping the advance warning function switched on at all times.


Depending on the infotainment system installed in the vehicle, the advance warning function may be adjusted as follows:

- Ready
- Medium
- Delayed
- Deactivated

SEAT recommends driving with the function in “Medium” mode.

Switching distance warning on and off


If the safe distance with regard to the vehicle in front is exceeded, the relevant warning will appear on the instrument panel display . In this case, increase the safe distance.

The distance warning may be switched on and off in the Easy Connect system using the **CAR** button and the **Setup** and **(Driver assistance)** function buttons »»  page 26.

The system will store the setting for the next time the ignition is switched on.

SEAT recommends keeping the distance warning switched on at all times.

Temporarily switching the Front Assist system off in the following situations

In the following situations the Front Assist Monitoring System should be deactivated due to the system's limitations »» :

- When the vehicle is to be towed.
- If the vehicle is on a test bed.
- When the radar sensor is damaged.
- If the radar sensor takes a heavy knock, for example in a rear collision.
- If it intervenes several times unnecessarily.
- If the radar sensor is covered temporarily with some kind of accessory, such as an additional headlight or the like.
- When the vehicle is to be loaded on a lorry, ferry or train.

WARNING

If the Front Assist is not switched off in the situations described, serious accidents and injuries may occur.

- **Switch off the Front Assist in critical situations.**

System limitations

The Front Assist Monitoring System has certain physical limitations inherent in the system. Thus, in certain circumstances some of

the system's reactions may be inopportune or be delayed from the driver's standpoint. So pay attention in order to intervene if necessary.

The following conditions may cause the Front Assist Monitoring System not to react or do so too late:

- On taking tight bends.
- Pressing the accelerator all the way down.
- If the Front Assist is switched off or damaged.
- If the ASR has been manually disconnected.
- If the ESC is controlling.
- If several brake lights of the vehicle or electrically connected trailer are damaged.
- If the radar sensor is dirty or covered.
- If there are metal objects, e.g. rails on the road or sheets used in road works.
- If the vehicle is reversing.
- If the vehicle over-accelerates.
- In case of snow or heavy rain.
- In case of narrow vehicles, such as motorbikes.
- Misaligned vehicles.
- Vehicles crossing the other's path.

- Vehicles approaching in the opposite direction.
- Special loads and accessories of other vehicles that jut out over the sides, backwards or over the top.

City Emergency braking function



Fig. 187 On the instrument panel display: advance warning message

The City Emergency braking function is part of the Front Assist monitoring and is active whenever the system is switched on.

Depending on the equipment, the City emergency braking function may be switched on and off in the Easy Connect system using the **CAR** button and the **Setup** and

Driver assistance function buttons
» **page 26.**

The City Emergency braking function picks up, at speeds between 4 km/h (2.5 mph) and 30 km/h (19 mph) approximately, the traffic situation in front of the vehicle up to a distance of about 15 m.

If the system detects a possible collision with a vehicle in front of it, the vehicle prepares for a possible emergency braking » **▲**.

If the driver fails to react to a possible collision, the system may brake the vehicle automatically, by progressively increasing braking effect driving to reduce speed in the event of a collision. The system can thus help to reduce the consequences of an accident.

Status display

Automatic deceleration by means of the City Emergency braking function is displayed on the instrument panel by means of the advance warning » **Fig. 187**¹⁾.

▲ WARNING

The smart technology included in the City Emergency braking function cannot defy the laws of physics. The driver is always responsible for braking in time.

¹⁾ The symbol on the instrument panels with colour display is in colour.

- Adapt your speed and safe distance to the vehicle in front of you at all times to suit visibility, weather, road and traffic conditions.
- The City Emergency braking function alone cannot prevent accidents or serious injury.
- In complex driving situations, the City Emergency braking function may issue unnecessary warnings and intervene inopportunistically in braking, such as in work areas or if there are metal rails.
- If the operation of the City Emergency braking function is impaired, for example, by dirt or because the radar sensor has lost its settings, the system may issue unnecessary warnings and intervene inopportunistically in the braking.
- The City emergency braking function only reacts to people if the vehicle has a pedestrian-monitoring system. The system does not react to animals or vehicles crossing your path or approaching head-on in the same lane.

Note

- When the City Emergency braking function causes a braking, the brake pedal is “harder”.
- Automatic interventions on the brakes by the City Emergency braking function may be

interrupted by pressing the clutch, accelerator or moving the wheel.

- The City Emergency braking function can brake the vehicle until it stops completely. However, the brake system does not halt the vehicle permanently. Use the foot brake!
- If several inopportune interventions occur, switch off the Front Assist and with it the City Emergency braking function. Take it to a specialised workshop, SEAT recommends visiting a SEAT dealership.
- If numerous unnecessary interventions occur, the City Emergency braking function may switch off automatically.

Pedestrian Monitoring*¹⁾

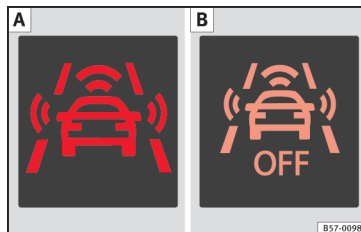


Fig. 188 On the instrument panel display: **A** Advance warning message. **B** Pedestrian Monitoring deactivated.

The pedestrian monitoring system can help prevent accidents involving pedestrians or reduce the consequences of an accident.

The system warns of danger of collision, prepares the vehicle for emergency braking, assists in the braking and brakes automatically.

If the system detects a possible collision with a pedestrian, it warns the driver with an acoustic signal and a message on the dash panel display » **Fig. 188**.


¹⁾ Depending on the vehicle equipment, pedestrian monitoring is not available in all countries.


The pedestrian monitoring system, including the advance warning, is automatically connected when the ignition is switched on »» page 165.

SEAT recommends always having the pedestrian monitoring system connected. The exceptions set out for the Front Assist system are equally valid for the pedestrian monitoring system »» page 210.

Switching the pedestrian monitoring system on and off

With the ignition on, the pedestrian monitoring system can be switched on and off as follows:

- Switch the system on and off in the infotainment system using the **CAR** button and the **Setup** and **Driver assistance** function buttons »»  page 26.

When the pedestrian protection system is switched off, the dash panel display shows a message indicating this »» **Fig. 188** . The pedestrian monitoring system is switched off with the Front Assist function.

WARNING

The technology in the pedestrian monitoring system cannot defy the laws of physics and only works within the system's limits. The driver is always responsible for braking in time. If the pedestrian monitoring system is-

sues a warning, brake the vehicle immediately with the brake pedal or swerve to avoid the pedestrian, depending on traffic conditions.

- The pedestrian monitoring system alone cannot avoid accidents or serious injury.
- In complex driving situations, the pedestrian monitoring system may issue unnecessary warnings and intervene unnecessarily in braking, such as in main roads with turnings.
- If the operation of the system is impaired, for example, because the radar sensor and camera are covered or have lost their settings, the system may issue unnecessary warnings and intervene inopportunistically in the braking.
- The driver must always be ready to take over the control of the vehicle.

Note

- When the vehicle is braked via the pedestrian monitoring system, the brake pedal becomes stiffer.
- Automatic interventions by the pedestrian monitoring system on the brakes may be interrupted by pressing the accelerator or moving the wheel.
- If the pedestrian monitoring system does not work as described in this chapter (e.g. if it intervening unnecessarily several times), switch it off, contact a specialist workshop immediately and request to have the system checked. SEAT recommends visiting a SEAT dealership for this.

Lane Assist system*

Introduction

WARNING

The intelligent technology in the Lane Assist system cannot change the limits imposed by the laws of physics and by the very nature of the system. Careless or uncontrolled use of the Lane Assist system may cause accidents and injury. The system is not a replacement for driver awareness.

- Always adapt your speed and the distance to the vehicles ahead in line with visibility, weather conditions, the condition of the road and the traffic situation.
- Always keep your hands on the steering wheel so it can be turned at any time.
- The Lane Assist system does not detect all road markings. The road surfaces, road structures or objects in poor condition can be incorrectly detected as road markings under certain circumstances by the Lane Assist system. In such situations, switch the Lane Assist system off immediately.
- Please observe the indications on the instrument panel and act as is necessary.
- Always pay attention to the vehicle's surroundings.
- When the area of vision of the camera becomes dirty, covered or is damaged, the Lane Assist system function can be affected. »»

ⓘ CAUTION

In order to avoid influencing the operation of the system, the following points must be taken into account:

- Regularly clean the area of vision of the camera and keep it in a clean state, without snow or ice.
- Do not cover the area of vision of the camera.
- Check that the area of vision of the wind-screen camera is not damaged.

ⓘ Note

- The Lane Assist system has been exclusively developed for driving on paved roads only.
- If the Lane Assist system does not work as described in this chapter, do not use it and contact a specialised workshop.
- If there is a fault in the system, have it checked by a specialised workshop.

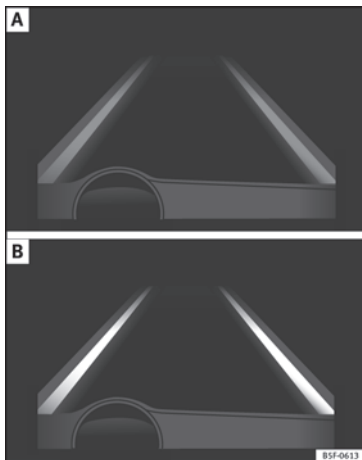
Indications on the display and lamps

Fig. 189 On the instrument panel display: Indication on the Lane Assist system display (example 1).

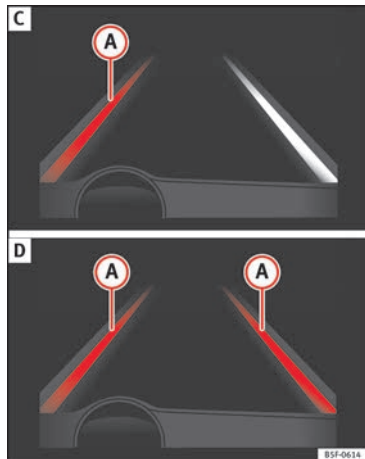


Fig. 190 On the instrument panel display: Indication on the Lane Assist system display (example 2).

Status display

- The system is active, but not available, either because the minimum speed has not been reached or because the lane lines are not recognised »» **Fig. 189 A.**
- The system is active and available, both lane lines are recognised. The steering angle is not being corrected at this moment »» **Fig. 189 B.**

- The system is operational, the highlighted line (A) indicates that there was a risk of involuntarily crossing the lane line and that the steering is being adjusted to correct the angle »» Fig. 190 C.
- The two lines (A) light up simultaneously when both lane lines are recognised and the Lane Assist function is active »» Fig. 190 D.

Control lamps



Blinks or lights up yellow: Lane Assist active but not available.

The system can not accurately recognise the lane. Please see page 216, the Lane Assist system is not available (the control lamp is lit up yellow).



Blinks or lights up green:

Lane Assist system active and available.

WARNING

Observe the safety warnings »» ⚠ in Warning and control lamps on page 107.

Operation



Fig. 191 In the windscreen: field of vision of the Lane Assist system camera.

Using the camera located in the windscreen, the Lane Assist system detects the possible lines dividing the lanes. When the vehicle involuntarily approaches a dividing line it has detected, the system notifies the driver with a *corrective steering movement*. This movement can be over-regulated at any time.

No warning is produced with the turn signals activated, given that the Lane Assist system understands that a lane change is required.

Steering wheel vibration

The following situations can cause vibration in the steering wheel and require the driver to take active control of driving:

- When the limits of the very nature of the system are reached.

- When the maximum rotational torque during the corrective steering movement is not enough to keep the vehicle inside the lane.
- When no lane is detected during the corrective steering movement.

Switching the Lane Assist system on or off

Through the Easy Connect system

- Push the Easy Connect button (CAR)
- Push the (Setup) function button
- Press the function button (Driver assistance) to open the menu.

OR: through the **driving assist** button on the turn signal level*.

The **Lane centring guide** is activated/deactivated in the Easy Connect system using the (CAR) button and the button on the (Setup) function »» page 108.

Self-deactivation: the Lane Assist system can be automatically deactivated if there is a system malfunction. The control lamp disappears.

Hands-Off Function

In the absence of steering wheel activity the system alerts the driver with acoustic signals and a text message on the dash panel asking to actively take over the steering. »»

If the driver does not react to this, the system also alerts the driver with a little shaking motion through the brakes and, if the vehicle has it, activates the Emergency Assist function »» page 218.

In vehicles without Emergency Assist, the adaptive lane guidance function will be disabled after the corresponding warnings to the driver.

The lane assist system is active but it is not available (the control lamp is lit up yellow)

- When driving at speeds below 65 km/h (38 mph).
- When the Lane Assist system does not detect the dividing lines of the road. For example, in the event warnings indicating road works, and snow, dirt, moisture or reflections.
- When the radius of a curve is too small.
- When no road markings can be seen.
- When the distance to the next marking to too great.
- When the system does not detect any clear and active steering movement during a long period of time.
- Temporarily, in the event of very dynamic driving styles.
- If a turn signal is activated.
- With the stability control system (ESC) in Sport mode or switched off.

Side Assist PLUS

If the vehicle is also equipped with Side Assist and the system is switched on, the driver is alerted when changing lanes during a possible critical situation (level of information, warning level) through a corrective steering wheel intervention. This occurs even if the turn signal is activated in the corresponding direction. If the driver over-regulates the steering wheel intervention, an additional warning is given through a vibration in the steering wheel.

Note

- Before starting a journey, verify that the field of vision of the camera is not covered »» Fig. 191.
- Always keep the field of vision of the camera clean.

Switching off the Lane Assist system in the following situations

Due to the limits of the Lane Assist system, switch it off in the following situations:

- When more attention is required of the driver
- When driving in a sporty style
- In unfavourable weather conditions
- On roads in poor condition

- In areas of road works

Traffic Jam Assist


Description and operation

 »» table on page 2

Traffic Jam Assist helps the driver keep the car within its lane and to move in convoy in case of traffic congestion or slow traffic.

Traffic Jam Assist is an additional function of Lane Assist »» page 213 and combines Lane Assist functions with Adaptive Cruise Control (ACC) »» page 197. Therefore, it is essential that you read these two chapters carefully and note the limitations of the systems and the information about them.


Operation of Traffic Jam Assist

At speeds of below 60 km/h (40 mph), Traffic Jam Assist can maintain a (temporary) distance preset by the driver with respect to the vehicle ahead and help stay within the lane »» .


To do this, the system automatically controls the acceleration, brakes and steering, and slows down the vehicle if necessary **until it stops fully** before a vehicle that has stopped, before moving off again automatically.

Traffic Jam Assist is designed only for use on motorways and wide roads. Therefore, never use it in city traffic.

Switching Traffic Jam Assist on and off

If Lane Assist is on, » page 213 Traffic Jam Assist is switched on and off in the infotainment system using the **CAR** button and the **Setup** and **Driver assistance** function buttons »  page 26.

It is activated by switching on Lane Assist and the lane centring guide in the infotainment system. If the lane centring guide is not active, the Traffic Jam Assist system is not active

Traffic Jam Assist may be disconnected using the button for driver assistance systems together with Lane Assist »  page 30.

Technical requirements for using Traffic Jam Assist

- Lane Assist must be activated » page 213, Lane Assist system*.
- Adaptive Cruise Control (ACC) must be connected and active » page 197.
- The selector lever must be in the **D/S** position or in the Tiptronic selection track.
- The speed must be below 60 km/h (38 mph).
- The lane centring guide must be active » page 215.

Traffic Jam Assist is not active (the Lane Assist control light turns yellow)

- If any of the conditions mentioned on page 217, Technical requirements for using Traffic Jam Assist are no longer met.
- If any of the conditions required for operation of the Lane Assist are not met » page 213.
- If any of the conditions necessary for the adaptive cruise control (ACC) to work are no longer fulfilled » page 197.

Situations in which Traffic Jam Assist must be switched off

Due to the limitations of the system, Traffic Jam Assist must always be switched off in the following situations:

- When more attention is required by the driver.
- When driving in a very sporty style.
- In adverse weather conditions, e.g. in case of snow or heavy rain.
- When driving on roads in poor condition.
- In sections with roadworks.
- In city journeys.

WARNING

The smart technology incorporated into Traffic Jam Assist cannot defy the laws of physics; it only works within the limits of the sys-

tem. Accidents and severe injury may occur if Traffic Jam Assist is used negligently or involuntarily. The system is not a replacement for driver awareness.

- Adapt your speed and safe distance to the vehicle in front of you at all times to suit the visibility, weather, road and traffic conditions.
- Do not use Traffic Jam Assist in city journeys.
- Do not use Traffic Jam Assist if there is poor visibility, for example, in case of snow, ice, rain or loose gravel, or on steep or slippery sections or flooded roads.
- Do not use Traffic Jam Assist offroad or on roads where the surface is not firm. Traffic Jam Assist has been designed for use on paved roads only.
- Traffic Jam Assist does not react to people or animals or vehicles crossing your path or that approach you head-on down the same lane.
- If Traffic Jam Assist does not reduce speed sufficiently, brake the vehicle immediately by applying the pedal.
- If the vehicle continues to move when you wish it to stop after a driver intervention prompt, brake the vehicle by applying the pedal.
- If *driver intervention is requested* on the dash panel display, immediately resume control of the vehicle.
- Keep your hands on the wheel at all times to be ready to intervene in the steering at any »

time. The driver is always responsible for keeping the vehicle in its own lane.

- Always be prepared to take charge of driving (accelerating or braking) yourself.

Note

- If Traffic Jam Assist does not work as described in this chapter, stop using it and contact a specialised workshop.
- If the system is faulty, take it to a specialised workshop and have it checked.

Emergency Assist


Description and operation

Emergency Assist detects whether there is inactivity by the driver and can automatically keep the car within the lane and stop it altogether if necessary. This way the system can actively help avoid an accident.

Emergency Assist is an additional function of Lane Assist » page 213 and combines Lane Assist functions with Adaptive Cruise Control (ACC) » page 197. Therefore, it is essential that you read these two chapters carefully and note the limitations of the systems and the information about them.

Operation of Emergency Assist

Emergency Assist detects when the driver ceases to perform any activity and repeatedly requests that he/she regain active control of the vehicle, through the use of optical and acoustic warnings and by applying the brakes.

If the driver continues to do nothing, the system automatically takes over the accelerator, brakes and steering in order to brake the vehicle and keep it in its lane » . If the remaining braking distance is sufficient, if necessary the system slows down the vehicle **until it stops completely** and automatically switches on the electronic parking brake » page 170.

When the Emergency Assist is actively adjusting, the hazard warning lights come on » page 135 and the vehicle makes slight zig-zag movements in the lane in order to warn other drivers.

Switching the Emergency Assist on and off

The Emergency Assist is switched on automatically when the Lane Assist is switched on » page 213.

Technical requirements for using the Emergency Assist

- The adaptive cruise control (ACC) must be switched on » page 197.

- The Lane Assist must be switched on » page 213.
- The selector lever must be at the **D/S** position or in the Tiptronic selection track.
- The system must have detected a lane separation line on both sides of the vehicle » **Fig. 190**.

The following conditions may cause the Emergency Assist not to react or to switch off automatically:

- If the driver accelerates, brakes or moves the steering wheel.
- If any of the conditions mentioned in » page 218, Technical requirements for using the Emergency Assist are not fulfilled.
- If any of the conditions required for operation of the Lane Assist are not met » page 213.
- If any of the conditions necessary for the adaptive cruise control (ACC) to work are no longer fulfilled » page 197.

WARNING

The smart technology incorporated into the Emergency Assist cannot overcome the limits imposed by the laws of physics; it only works within the limits of the system. The driver is responsible for driving the vehicle.

- Adapt your speed and safe distance to the vehicle in front of you at all times to suit the

visibility, weather, road and traffic conditions.

- Keep your hands on the wheel at all times to be ready to intervene in the steering at any time.
- The Emergency Assist alone cannot always avoid accidents or serious injuries.
- If the operation of the Emergency Assist is impaired, for example if the radar sensor of the adaptive cruise control (ACC) or the Lane Assist camera are covered or have lost their settings, the system may intervene inopportunistically in braking or in steering.
- The Emergency Assist does not react to people or animal or vehicles crossing your path or which approach you head-on in the same lane.

WARNING

If the Emergency Assist Intervenes inopportunistically, serious accidents and injuries may occur.

- If the Emergency Assist does not operate properly, switch off the Lane Assist
»» page 213. Doing so will also switch off the Emergency Assist.
- Have the system checked by a specialised workshop. SEAT recommends visiting a SEAT dealership for this.

Note

- Automatic interventions by the Emergency Assist on the brakes may be interrupted by pressing the accelerator or brake or by moving the wheel.
- Hazard warning lights that come on automatically can be switched off by pressing the accelerator or the break, moving the steering wheel or pressing the hazard warning light switch.
- If this occurs, the Emergency Assist may decelerate the vehicle until it comes to a complete stop.
- When the Emergency Assist is activated, it is only available again after the ignition has been switched off and back on again.

Blind spot detector (BSD) with parking assistance (RCTA)*

Introduction

 » table on page 2

The blind spot detector (BSD) helps to detect the traffic situation behind the vehicle.

The integrated parking assistant (RTA) helps the driver when backing out of a parallel parking spot and in manoeuvring.

The blind spot detector has been developed for driving on paved roads.

WARNING

The smart technology incorporated into the blind spot detector (BSD) with parking assistance (RCTA) included cannot overcome the limits imposed by the laws of physics; it only works within the limits of the system. Accidents and severe injury may occur if the blind spot detection system or the rear cross traffic alert are used negligently or involuntarily. The system is not a replacement for driver awareness.

- Adapt your speed and safe distance to the vehicle in front of you at all times to suit visibility, weather, road and traffic conditions.
- Keep your hands on the wheel at all times to be ready to intervene in the steering at any time.

- Pay attention to the control lamps that may come on in the external rear view mirrors and on the instrument panel, and follow any instructions they may give.

- The blind spot assistant could react to any special constructions that might be present on the sides of the vehicle: e.g. high or irregular dividers. This may cause erroneous warnings.

- Never use the blind spot detector with rear cross traffic alert on unpaved roads. The blind spot detector with rear cross traffic alert has been designed for use on paved roads.

- Always pay attention to the vehicle's surroundings.

- Never use the blind spot detector or the parking assistant if the radar sensors are dirty.

- The external rear view mirror control lamps may have limited functionality due to solar radiation.

CAUTION

- The radar sensors on the rear bumper may be damaged or shifted in the event of a collision, for example, when entering or exiting a parking space. This may result in the system disconnecting itself, or at least possibly having its functionality diminished.

- In order to ensure that the radar sensors work properly, keep the rear bumper free of snow and ice and do not cover it.

- The rear bumper should only be painted with paint authorised by SEAT. The blind spot detector's functions may be limited or work incorrectly if other paints are used.

Note

If the blind spot detector with parking assistant does not work as described in this chapter, do not use it and contact a specialised workshop.

Control lamps

Control lamp in external rear view mirrors:




Lights up

Lights up once briefly: the blind spot detector is activated and ready to operate.

Lights up: blind spot detector has detected a vehicle in the blind spot.



Flashes

The blind spot detector has detected a vehicle in the blind spot and the turn signal has been turned on in the direction of the detected vehicle » .

For vehicles that are also equipped with Lane Assist » page 213, a warning to switch lanes will also appear even though the turn signal has not been engaged (blind spot detector "Plus").

Some warning and control lamps will light up briefly when the ignition is switched on to check certain functions. They will switch off after a few seconds.

If there are no indications from the control lamp in the external rear view mirror, this means that the blind spot detector has not detected any other vehicles in the area »» ⚠.

If the dipped beam is on, then the control lamps in the external rear view mirrors will be dimmed (night mode).

⚠ WARNING

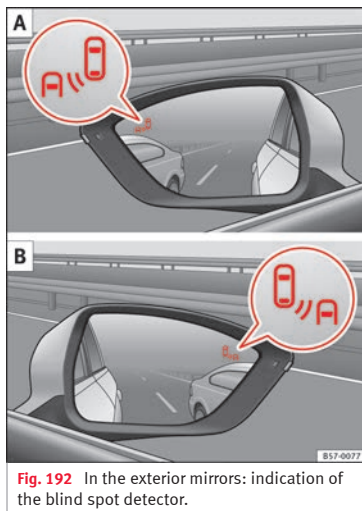
If the warning lamps and the corresponding messages are ignored when they light up, the vehicle may stall in traffic and cause accidents and severe injuries.

- Never ignore the warning lamps or messages.
- Carry out the necessary operations.

ⓘ CAUTION

Failure to heed the control lamps and corresponding text messages when they light up may result in damage to the vehicle.

Blind spot detector (BSD)



The blind spot detector uses radar sensors to monitor the areas behind the vehicle »» **Fig. 193**. The system does this by measuring the vehicle's distance from other vehicles and its speed differential. The blind spot detector will not work at speeds of less than approx. 15 km/h (9 mph). The system uses optical signals in the external rear view mirrors to notify the driver.

Indication in the external rear view mirrors

The control lamp (expanded view) provides an indication in the corresponding external mirror »» **Fig. 192** regarding the traffic situation behind the vehicle, if it is deemed to be critical. The control lamp of the left-hand external mirror indicates the traffic situation to the left of the vehicle, and the control lamp of the right-hand external mirror indicates the traffic situation to the right of the vehicle. »»

In the case of retrofitted tinted windows or windows with tinted film, the indications of the external mirrors may not be seen clearly or correctly.

Keep the external mirrors clean and free of snow and ice, and do not cover them with adhesives or other similar materials.

Radar sensors

The radar sensors are located on the left and right of the bumper and are not visible from

the outside »» **Fig. 193**. The sensors have a range of approx. 20 metres behind the vehicle, including the blind spots to the left and right of the vehicle. The range to the sides of the vehicle is a bit larger than the width of a lane.

The lane width is not detected individually, but is rather pre-configured in the system. Thus if you are driving in wide lanes or in between two lanes, the indications may be incorrect. Furthermore, the system can detect

vehicles driving in the lane next to you (if there are any), and can also detect stationary objects such as dividers, and thus give an incorrect indication.

Driving situations

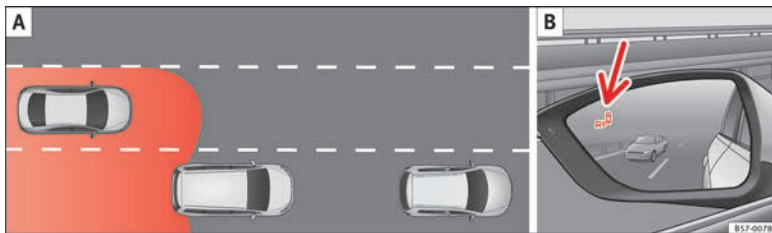


Fig. 194 Schematic diagram: **A** Passing situation with traffic behind the vehicle. **B** Indication from the blind spot detector in the left-hand external mirror.

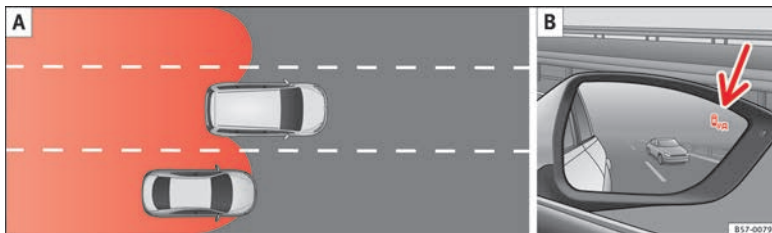


Fig. 195 Schematic diagram: **A** Situation of passing and then moving into the right-hand lane. **B** Indication from the blind spot detector in the right-hand external mirror.

In the following situations, an indication will be displayed in the external mirror »» **Fig. 194 B** (arrow) or »» **Fig. 195 B** (arrow):

- When being overtaken by another vehicle »» **Fig. 194 A**.
- When overtaking another vehicle »» **Fig. 195 A** with a speed differential of approx. 10 km/h (6 mph). If the vehicle is pass-

ing at a considerably higher speed, no indication will be displayed.

The faster the vehicle approaches, the sooner an indication will be displayed in the external mirror, because the blind spot detector takes into account the speed differential with other vehicles. Thus even though the distance from the other vehicle is identical, the indication will appear sooner in some cases and later in others.

Physical limitations inherent to the system

In some situations the blind spot detector may not interpret the traffic situation correctly. E.g. in the following situations:

- on tight bends;
- in the case of lanes with different widths;
- at the top of slopes;
- in adverse weather conditions;

- in the case of special constructions to the side of the vehicle, e.g., high or irregular dividers.

Parking assistant (RTA)



Fig. 196 Schematic representation of the rear cross traffic alert: monitored zone around the vehicle being parked.

The parking assistant uses the radar sensors on the rear bumper » **Fig. 193** to monitor the traffic crossing behind the vehicle as it backs out of a parallel parking space or as it is being manoeuvred, for example in very low visibility conditions.

If the system detects that someone else on the road is approaching the rear of the vehicle » **Fig. 196**, an acoustic alarm is heard.

- The acoustic alarm comes from the same acoustic indicator used by the ParkPilot.

In addition to the acoustic alarm, the driver is also informed by means of a visual signal on the radio screen. This signal is displayed in the form of a red strip at the back of the image of the vehicle on the radio screen. This strip displays the side of the vehicle towards which traffic is approaching.

Automatic braking to reduce damages

If the rear cross traffic alert detects that someone else on the road is approaching the rear of the vehicle and the driver does not step on the brake, the system will engage the brakes automatically.

The parking system helps the driver by automatically engaging the brakes to reduce any damage. The system will brake automatically if the vehicle is reversing at a speed of approximately 1-12 km (1-7 mph). Once it has detected that the vehicle has stopped, the system will keep the vehicle stopped for approx. 2 seconds.

After automatically braking to reduce damage, the system will not be able to automatically brake again for approximately 10 seconds.

You can interrupt the automatic braking by stepping hard on the accelerator pedal or the brake pedal in order to regain control of the vehicle.

⚠ WARNING

The smart technology incorporated into the rear cross traffic alert cannot overcome the limits imposed by the laws of physics; it only works within the limits of the system. The parking assistant function should not tempt you into taking any risks. The system is not a replacement for driver awareness.

- The system should never be used in limited visibility conditions or complicated traffic, e.g., in high-traffic areas or when crossing multiple lanes.
- Be sure to always be aware of the vehicle's surroundings, since the system often fails to detect things such as bicycles or pedestrians.
- The rear cross traffic alert itself will not brake the vehicle to a complete stop.

Using the blind spot detector (BSD) with parking assistant (RTA)

Activating and deactivating the blind spot detector (BSD) with parking assistant (RTA)

The blind spot detector with parking assistant can be switched on and off by accessing the **Assistance systems** menu on the dash panel display using the steering wheel controls. If the vehicle is equipped with a multifunction camera, it can also be accessed by means of the driver assistance systems key located on the main beam headlight lever.

Open the **Assistants** menu.

- BSD
- Parking Assist.

If the verification box on the control panel is checked , the functionality will be automatically activated at ignition.

When the blind spot detector is ready to operate, the indications in the external mirrors will turn on briefly as confirmation.

When the vehicle is restarted, the last adjustment in the system will remain active.

If the blind spot detector was automatically deactivated, it will only be possible to restart the system after turning the vehicle off and restarting it.

Automatic deactivation of the blind spot detector (BSD)

The radar sensors of the blind spot detector with rear cross traffic alert will be automatically deactivated when, among other reasons, one of the sensors is detected to be permanently covered. This may be the case if, for example, there is a layer of snow or ice in front of one of the sensors.

The relevant text message will appear in the dash panel display.

Trailer mode

The Blind spot detector and the rear cross traffic alert will be automatically deactivated and it will be impossible to activate them if the tow hitch is electrically connected to a trailer or other similar object.

As soon as the driver starts to drive with a trailer connected electrically to the vehicle, a message will appear on the instrument panel display indicating that the blind spot detector and the rear cross traffic alert are deactivated. Once the trailer has been unhitched from the vehicle, if you want to use the blind spot detector and the rear cross traffic alert, you will have to reactivate them in the corresponding menu.

If the towing hitch is not factory equipped, then the blind spot detector and the rear cross traffic alert will have to be deactivated manually when driving with a trailer.

SEAT Drive Profile*

Introduction

The SEAT Drive Profile enables the driver to choose between four profiles or modes, **Eco**, **Normal**, **Sport** and **Individual**, that modify the behaviour of various vehicle functions, providing different driving experiences.

In addition, the 4Drive version features the **Offroad** and **Snow** profiles.

The **Individual** profile can be configured according to personal preferences. The other profiles have a fixed configuration.

Description

Depending on the equipment fitted in the vehicle, SEAT Drive Profile can operate on the following functions:

Engine

Depending on the profile selected, the engine responds more spontaneously or more in harmony with the movements of the accelerator. Additionally, when the **Eco** profile is selected, the Start-Stop function is automatically activated.

In vehicles with automatic transmission, the gear change points are modified to position them in lower or higher engine speed ranges. Additionally, the **Eco** profile activates the inertia function, enabling consumption to be further reduced.

In manual gearbox vehicles, the **Eco** profile causes the gear change recommendation indications that appear on the dash panel to vary, facilitating more efficient driving. »

Address

The power steering varies its driving modes and adapts to the profile selected, thus offering the best behaviour for each situation.

Air conditioning

In vehicles with Climatronic, this can operate in Eco mode, especially restricting fuel consumption.

Adaptive cruise control (ACC)

The acceleration gradient of the adaptive cruise control varies according to the active driving profile » **page 197**.

Electronic stability control (ESC)

In the **Offroad** and **Snow** driving profiles, the electronic stability control (ESC) » **page 173** adjusts to adapt to the terrain.

In addition, hill descent control (HDC) is activated in the **Offroad** profile » **page 190**.

Adjusting driving profile



Fig. 197 Centre console: Driving Experience button.

» **table on page 2**

You can select the **Eco**, **Normal**, **Sport**, **Individual**, **Offroad**¹⁾ and **Snow**¹⁾ profiles in the following way:

- Turn the Driving Experience button until the required profile lights up on the Easy Connect system display as well as on the Driving Experience button » **Fig. 197**.
- **OR**: select the required profile on the touch-screen of the Easy Connect system, in the menu that opens up on turning the Driving Experience button.

The features of each profile can be seen by pressing the **Profile information** button of the Easy Connect system display.

In the **Individual** profile it is possible to configure the characteristics of the vehicle using the **Profile setup** button of the Easy Connect system display.

An icon on the Easy Connect system display provides information about the active profile if it is different than **Normal**. The selector identifies the profile chosen by means of a red LED light.

Driving profile	Characteristics
Eco	Places the vehicle in a particularly low state of consumption, facilitating a fuel-saving driving style that is respectful to the environment.
Normal	Offers a balanced driving experience, suitable for everyday use.
Sport	Provides a complete dynamic performance in the vehicle, enabling the user a more sporty driving style.
Individual	It allows you to personalise the configuration. The functions that can be adjusted depend on the equipment fitted in the vehicle.

¹⁾ Only for 4Drive models.

Driving profile	Characteristics
Offroad ^{a)}	It adjusts the vehicle's parameters in order to maintain optimal off-road driving.
Snow ^{a)}	It adjusts the vehicle's behaviour for driving on slippery road surfaces, optimising grip and manoeuvrability.

^{a)} Only for 4Drive models.

WARNING

When operating SEAT Drive Profile, pay attention to all traffic: doing otherwise could cause an accident.

Note

- When the vehicle is switched off it will always store the driving profile that was selected when the ignition key was removed, except in the following cases:
 - When the vehicle is restarted after using the Sport profile, the engine and the gearbox will not restart in the sportiest setting so as to reduce fuel consumption. To return the engine and the gearbox to their sportiest position, select the Sport driving profile again.
 - When the vehicle is restarted after using the Offroad or Snow settings, the system is always activated in the Normal profile.

- Your speed and driving style must always be adjusted to visibility, weather, and traffic conditions.
- The Eco profile is not recommended when towing a vehicle.

Kick-down

The Kick-down feature allows maximum acceleration to be reached.

If the Eco* profile has been selected in the **SEAT Drive Profile**» page 226 and the accelerator is pressed beyond a hard point, the engine power is automatically controlled to give your vehicle maximum acceleration.

WARNING

Please note that if the road surface is slippery or wet, the kick-down feature could cause the driving wheels to spin, which could result in skidding.

Traffic sign detection system*

Introduction

The traffic sign detection system records the standard traffic signs in front of the vehicle with a camera located on the base of the interior mirror and provides information about speed limits and overtaking prohibitions. Within its limitations, the system also displays additional signals, such as time-specific prohibitions, signs for vehicles towing trailers » page 255 or limitations that only apply in the event of rain. Even on journeys without signs, the system may display any applicable speed limits.

In Germany, on motorways and vehicle roads, besides speed limits and overtaking provisions the system also displays the end of prohibition signs. The valid speed limit at the time in other countries is always shown.

Countries in which it works

When this instruction manual went to print, the traffic sign detection system was operating in the following countries:

Andorra, Austria, Belgium, Bulgaria, Croatia, Cyprus, Czech Republic, Denmark, Estonia, Finland, France, Germany, Greece, Hungary, Iceland, Ireland, Italy, Latvia, Liechtenstein, Lithuania, Luxembourg, Malta, Monaco, the Netherlands, Northern Ireland, Norway, Poland, Portugal, Romania, San Marino, Slova-

kia, Slovenia, Spain, Sweden, Switzerland, Turkey, the United Kingdom and the Vatican City.

WARNING

The technology in the traffic sign detection system cannot change the limits imposed by the laws of physics and only works within the system's limits. Do not let the extra convenience afforded by the traffic sign detection system tempt you into taking any risks when driving. The system is not a replacement for driver awareness.

- Adapt your speed and driving style to suit visibility, weather, road and traffic conditions.
- Poor visibility, darkness, snow, rain and fog may lead to the system failing to display traffic signs or not displaying them correctly.
- If the camera's field of vision is dirty, covered or damaged, system operation may be impaired.

WARNING

The driving recommendations and traffic indications shown on the traffic sign detection system may differ from the actual current traffic situation.

- The system may not detect or correctly show all the traffic signs.
- Traffic signs and traffic regulations have priority over the recommendations and displays provided by the system.

Note

In order not to compromise the system's operation, please take the following points into account:

- Regularly clean the area of vision of the camera and keep it in a clean state, without snow or ice.
- Do not cover the field of vision of the camera.
- Always replace damaged or worn blades when required to avoid lines on the camera's field of vision.
- Check that the windscreen is not damaged in the area of the camera's field of vision.

Note

- The use of outdated maps on the navigation system may cause the system to show traffic signs incorrectly.
- In the waypoints mode of the navigation system, the traffic sign detection system is only partly available.

Indication on display

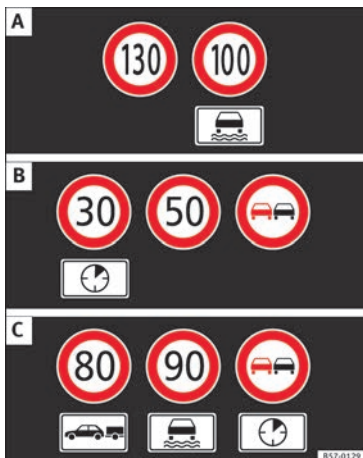



Fig. 198 On the instrument panel display: examples of speed limits or overtaking prohibitions with their respective additional signs.

The traffic signs detected by the system are displayed on the dash panel display » **Fig. 198** and, depending on the navigation system fitted in the vehicle, on the infotainment system as well »  page 26.

Traffic sign detection system messages	Cause and solution
There are no traffic signs available	The system is booting up. OR ELSE: the camera has not recognised any obligation or prohibition signs.
Error: Detection of traffic signs	There is a fault in the system. Have the system checked by a specialised workshop.
Speed warning currently unavailable.	The speed warning function of the traffic sign detection system is faulty. Have the system checked by a specialised workshop.
Detection of traffic signs: Clean the windscreen!	The windscreen is dirty in the camera area. Clean the windscreen.
Detection of traffic signs: Limited at the moment	The navigation system is not transmitting any data. Check that the navigation system's maps are up-to-date. OR ELSE: the vehicle is currently in a region that is not included in the navigation system's map.
No data available	The traffic sign detection system does not work in the current country.

⚠ WARNING

If messages are ignored, the vehicle may stall in traffic and cause accidents and severe injuries.

- Never ignore the messages displayed.
- Stop the vehicle at the next opportunity and in a safe place.



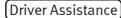
i Note

Failure to heed the control lamps and corresponding text messages when they light up may result in damage to the vehicle.

Operation

The traffic sign detection system does not work in all countries » page 228, Countries in which it works. Keep this in mind when travelling abroad.

Activating and deactivating traffic sign display on the instrument panel

The permanent display of traffic signs on the instrument panel can be activated or deactivated on the infotainment system by means of the button  and the function buttons  and .

Display of traffic signs

When the traffic sign detection system is connected, a camera located on the base of the »

interior rear-view mirror records the traffic signs in front of the vehicle. After checking and evaluating the information from the camera, the navigation system and the current vehicle data, up to three valid traffic signs are displayed »» Fig. 198 B in conjunction with their corresponding additional signs.

First: The sign that is currently valid for the driver is shown in the left side of the screen For example, a maximum speed limit of **130 km/h (100 mph)** »» Fig. 198 A.

Second: A sign valid only in certain circumstances, e.g. **100 km/h (60 mph)** is shown second, together with the additional rain sign.


Additional sign: If the windscreen wiper is working while you are driving, the signal with the additional rain sign will be shown first, on the left, as it is the one that is applicable at the time.

Third: A sign valid only with restrictions, e.g. No overtaking at certain times, will be displayed third »» Fig. 198 C.


Speed warning

If the system detects that the permitted speed is exceeded, it may warn the driver with a “gong” and visually with a message on the dash panel display.

The speed warning can be adjusted or deactivated completely on the infotainment system

using the **CAR** button and the **Setup** and **Driver Assistance** function buttons »»  page 26. The speed is adjusted in steps of 5 km/h (3 mph) within a range of between 0 km/h (mph) and 20 km (12 mph) above the maximum speed permitted.

Trailer mode

In vehicles equipped with a towing bracket device from the factory and a trailer that is electrically connected to the vehicle, it is possible to activate or deactivate the display of specific traffic signs for vehicles with trailer, such as speed limits or overtaking prohibitions. Activation or deactivation is performed on the infotainment system by means of the button **CAR** and the function buttons **Setup** and **Driver Assistance** »»  page 26.

For trailer mode, the display of speed limits applicable to the type of trailer or to the legal provisions can be adjusted. The speed is adjusted in steps of 10 km/h (5 mph) within a range of between 60 km/h (40 mph) and 130 km (80 mph). If it is adjusted to a speed greater than that which is permitted in the country in question for driving with a trailer, the system automatically displays the usual speed limits, e.g. in Germany 80 km/h (50 mph).

If the speed warning for the trailer is deactivated, the system displays the speed limits as if there were no trailer hitched.

Limited operation

The traffic sign detection system has certain limitations. The following cases may lead the system to operate with limitations or not at all:

- In the case of poor visibility, e.g. in snow, rain, fog or intense mist.
- In cases of dazzling, e.g. caused by head-on traffic or by the sun.
- When driving at high speeds.
- If the camera is covered or dirty.
- If the traffic signs are out of the camera's field of vision.
- If the traffic signs are partially or totally covered, e.g. by trees, snow, dirt or other vehicles.
- In the case of traffic signs that do not fulfil the regulations.
- In the case of damaged or bent traffic signs.
- In the case of variable messages on overhead or gantry signs (LED-based variable traffic signs or other lighting units).
- If the maps on the navigation system are not up-to-date.
- In the case of adhesives affixed to vehicles that depict traffic signs, e.g. speed limits on lorries.

Fatigue detection (break recommendation)*

Introduction

The Fatigue detection informs the driver when their driving behaviour shows signs of fatigue.

WARNING

Do not let the comfort afforded by the Fatigue detection system tempt you into taking any risks when driving. Take regular breaks, sufficient in length when making long journeys.

- The driver always assumes the responsibility of driving to their full capacity.
- Never drive if you are tired.
- The system does not detect the tiredness of the driver in all circumstances. Consult the information in the section » page 231, System limitations.
- In some situations, the system may incorrectly interpret an intended driving manoeuvre as driver tiredness.
- No warning is given in the event of the effect called microsleep!
- Please observe the indications on the instrument panel and act as is necessary.

Note

- Fatigue detection has been developed for driving on motorways and well paved roads only.
- If there is a fault in the system, have it checked by a specialised workshop.

Function and operation



Fig. 199 On the instrument panel display: fatigue detection symbol.

Fatigue detection determines the driving behaviour of the driver when starting a journey, making a calculation of tiredness. This is constantly compared with the current driving behaviour. If the system detects that the driver is tired, an audible warning is given with a sound and an optic warning is shown with a symbol and complementary message on the instrument panel display » **Fig. 199**. The message on the instrument panel display is

shown for approximately 5 seconds, and depending on the case, is repeated. The system stores the last message displayed.

The message on the instrument panel display can be switched off by pressing the **OK/RESET** button on the windscreen wiper lever or the button **OK** on the multi function steering wheel » **page 29**.

The message can be recalled to the instrument panel display using the multifunction display » **page 29**.

Conditions of operation

Driving behaviour is only calculated on speeds above about 65 km/h (40 mph) up to around 200 km/h (125 mph).

Switching on and off

Fatigue detection can be activated or deactivated in the Easy Connect system with the button **CAR** and the function button **Setup** » **page 108**. A mark indicates that the adjustment has been activated.

System limitations

The Fatigue detection has certain limitations inherent to the system. The following conditions can limit the Fatigue detection or prevent it from functioning.

- At speeds below 65 km/h (40 mph)
- At speeds above 200 km/h (125 mph)

- When cornering
- On roads in poor condition
- In unfavourable weather conditions
- When a sporty driving style is employed
- In the event of a serious distraction to the driver

Fatigue detection will be restored when the vehicle is stopped for more than 15 minutes, when the ignition is switched off or when the driver has unbuckled their seat belt and opened the door.

In the event of slow driving during a long period of time (below 65 km/h, 40 mph) the system automatically re-establishes the tiredness calculation. When driving at a faster speed the driving behaviour will be recalculated.

Park Assist*

Introduction



 » table on page 2

The Park Assist system is an additional function of ParkPilot » page 239 and helps the driver to:

- find a suitable parking space,
- select a parking mode,

- park driving in reverse in suitable perpendicular and parallel spaces,
- park driving forwards in suitable perpendicular spaces,
- exit a parking space driving forwards from a parallel space.

In vehicles with a Park Assist system and factory radio the front, rear and side areas are represented, and the position of obstacles is shown relative to the vehicle.

The Park Assist system is subject to certain limitations inherent to the system and its use requires special attention by the driver »  .

WARNING

The smart technology incorporated into the Park Assist system cannot overcome the limits imposed by the laws of physics; it only works within the limits of the system. The greater convenience provided by Park Assist should never tempt you to take any risk that may compromise safety. The system is not a replacement for driver awareness.

- Any accidental movement of the vehicle could result in serious injury.
- Adapt your speed and driving style at all times to suit visibility, weather, road and traffic conditions.
- Certain surfaces of objects and garments do not reflect the ultrasound sensors' signals. The system cannot detect, at least cor-

rectly, these objects or people wearing such clothes.

- Ultrasound sensor signals may be affected by external sound sources. In certain circumstances this may prevent them from detecting people or objects.

- The ultrasound sensors have blind spots in which obstacles and people are not registered.

- Monitor the area around the vehicle at all times, since the ultrasound sensors do not detect small children, animals or certain objects in all situations.

WARNING

Quick turns of the steering wheel when parking or exiting a parking space with Park Assist can cause serious injury.

- Do not hold the steering wheel during manoeuvres to park or exit a parking space until the system requests it. Doing so disables the system during the manoeuvre, resulting in the parking being cancelled.

CAUTION

- In certain circumstances, the ultrasonic sensors do not detect objects such as trailer tongues, bars, fences, posts or thin trees, or an open (or opening) rear lid, which could damage the vehicle.

- Retrofitting of certain accessories to the vehicle, such as a bicycle rack, may interfere

with the operation of the Park Assist system and cause damage.

- The Park Assist system uses as a reference parked vehicles, curbs and other objects. Make sure that the tyres and wheels are not damaged while parking. If necessary, opportunistly interrupt the parking manoeuvre to avoid damaging the vehicle.

- The ultrasound sensors on the bumper may be damaged or shifted in the event of a collision, for example, when entering or exiting a parking space.

- If you use high-pressure or vapour equipment to clean the ultrasound sensors, do not apply it directly unless very briefly and always from a distance of more than 10 cm.

- A registration plate or plate holder on the front with larger than the space for the registration plate, or a registration plate that is curved or warped can cause:

- false detections,
- loss of sensor visibility,
- cancellation of the parking manoeuvre or defective parking.

- If one of the ultrasonic sensors is damaged, the area corresponding to that group of sensors (front or rear) is deactivated and cannot be activated until the fault is corrected. However, you can still use the sensors of the other bumper as per usual. If there is a fault in the system, consult a specialist workshop. SEAT recommends visiting a SEAT dealership for this.

Note

- In order to guarantee good system operation, keep the ultrasound sensors of the bumper clean, free of snow or ice, and do not cover them with adhesives or other objects.

- Certain sources of noise, such as rough asphalt or paving stones and the noise of other vehicles can induce the Park Assist system or ParkPilot to give erroneous warnings.

- In order to become familiar with the system and its functions, SEAT recommends that you practice operating the Park Assist system in an area where there is not too much traffic or in a car park.

Description of the Park Assist system

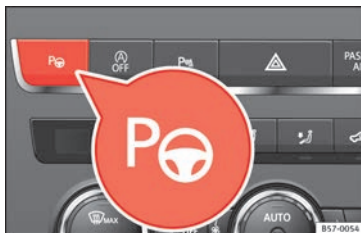


Fig. 200 At the top of the centre console: button to switch on the Park Assist system.

The components of Park Assist system are the ultrasonic sensors located in the front

and rear bumpers, the **Fig. 200** button to switch the system on and off and the messages on the instrument panel display.

Prematurely stopping or automatically interrupting the manoeuvres for parking or exiting a parking space

Park Assist interrupts the manoeuvres for parking or exiting a parking space in any of the following cases:

- Button **Fig. 200** is pressed.
- The speed exceeds approximately 7 km/h (4 mph).
- The driver takes hold of the steering wheel.
- The parking manoeuvre does not end within approximately 6 minutes following activation of the automatic steering.
- There is a fault in the system (the system is temporarily unavailable).
- ASR is switched off.
- ASR or ESC intervene with regulation.
- The driver door is opened.


To restart the manoeuvre it is necessary that none of these things occur and that button **Fig. 200** is pressed again.

Special Characteristics

The Park Assist system is subject to certain limitations inherent to the system. For example, it is therefore not possible to enter or exit a parking space on sharp bends.

While entering or exiting a parking space, a brief signal sounds to prompt the driver to change between forward and reverse gears. If this signal does not sound, the gear change will be indicated when the continuous signal sounds (object at 30 cm) in ParkPilot.


When the Park Assist system turns the steering wheel with the vehicle stationary, the in-

strument panel also displays the symbol . Press down the brake pedal so that the turn takes place with the vehicle stationary and the smallest possible number of manoeuvres take place in the parking space.

Trailer mode

The Park Assist system cannot be switched on if the factory-fitted towing bracket **»» page 255** is electrically connected to a trailer.

After changing a wheel

If, after changing a wheel, the vehicle stops entering and exiting parking spaces correctly, the circumference of the new wheel may be different and the system may need to adapt to it. The adaptation is automatic and takes place during driving. Making turns slowly, at less than 20 km/h (12 mph) may contribute to this adaptation process **»»  in Introduction on page 232.**

Selecting a parking mode

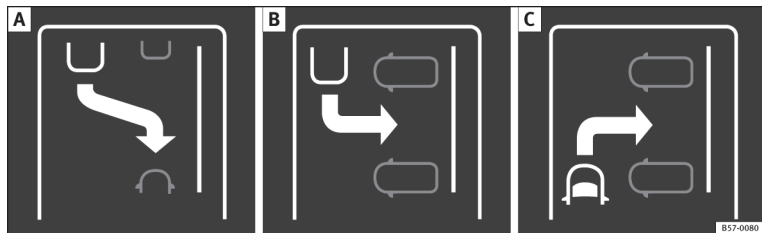


Fig. 201 Overview of reduced displays for parking modes: **[A]** Parallel parking in reverse. **[B]** Perpendicular parking in reverse. **[C]** Perpendicular parking forwards.



Fig. 202 On the instrument panel display: displaying the Park Assist system with reduced display.

Selecting a parking mode with Park Assist with prior step in front of the space

After activating the Park Assist system and after detecting a parking space, the display on the instrument panel proposes a parking mode. The Park Assist system selects the parking mode automatically. The selected mode is shown on the instrument panel display » **Fig. 202**. The reduced display of other possible parking modes is also shown » **Fig. 201**. If the mode selected by the sys-

tem does not correspond to the desired mode, you can select another mode by pressing button **P_{PA}** » **Fig. 200**.

	Action
1.	The necessary conditions to park with Park Assist have to be met » page 236.
	Press button P_{PA} .
2.	A control lamp on the button P_{PA} lights up when the system is switched on. Additionally, the selected parking mode is shown on the instrument panel display and the reduced display shows another parking mode it can be changed to.
3.	Turn on the corresponding turn signal towards the side of the road where you are parking. The instrument panel displays the side corresponding to the road. By default, if the turn signal is not on, it parks on the right in the direction of traffic.
	If necessary, press the P_{PA} button again to change parking mode.
4.	Once you have switched to all possible parking modes, if the P_{PA} button is pressed again, the system switches off.

	Action
5.	Press the P_{PA} button again to switch the system back on.
6.	Follow the instructions displayed on the instrument panel while paying attention to traffic and drive the vehicle past the parking space.

Special case of perpendicular parking space to park forwards without driving past first

	Action
1.	The necessary conditions to park with Park Assist have to be met » page 236.
2.	Drive forward towards the parking space while paying attention to traffic and stop the vehicle.
	Press the P_{PA} button <i>once</i> .
3.	A control lamp on the button P_{PA} lights up when the system is switched on. Additionally, the selected parking mode is shown on the instrument panel display without reduced display.
4.	Release the steering wheel » ⚠ in Introduction on page 232.

Park with Park Assist

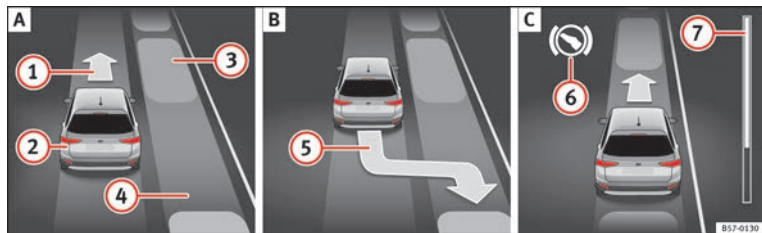


Fig. 203 On the instrument panel display: parallel parking. **A** Finding a parking space. **B** Parking position. **C** Manoeuvring.

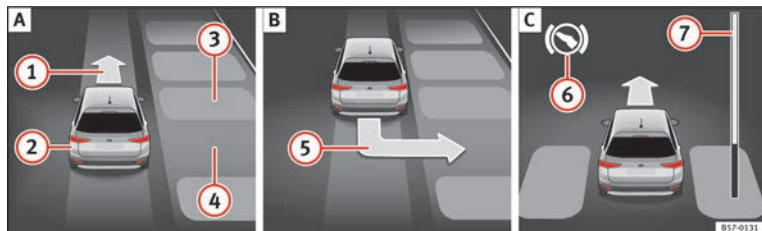


Fig. 204 On the instrument panel display: perpendicular parking. **A** Finding a parking space. **B** Parking position. **C** Manoeuvring.

Key to **Fig. 203** and **Fig. 204**:

- ① Message to move forwards
- ② Your vehicle
- ③ Parked vehicle
- ④ Parking space detected
- ⑤ Message to park
- ⑥ Message to press the brake pedal
- ⑦ Progress bar

Progress bars

The progress bar
 » **Fig. 203** ⑦ and » **Fig. 204** ⑦ on the screen of the instrument panel displays the relative distance to be covered. The greater the distance, the fuller the progress bar. When driving forward, the content of the progress bar decreases upwards, and when reversing, it decreases downwards.

Necessary conditions to park with Park Assist

For parallel parking spaces

For perpendicular parking spaces

The traction control system (ASR) must be turned on
 » page 174.

For parallel parking spaces	For perpendicular parking spaces
Do not exceed approximately 40 km/h (25 mph) when driving past the parking space.	Do not exceed approximately 20 km/h (12 mph) when driving past the parking space.
Keep a distance between 0.5 and 2.0 metres when driving past the parking space.	
Length of the space: length of the vehicle + 0.8 metres	Width of the space: width of the vehicle + 0.8 metres
Do not exceed approximately 7 km/h (4 mph) when parking.	

Parking

	Do the following:
1.	The necessary conditions have to be met to park with Park Assist » page 236 and the parking mode must be selected » page 234.
2.	Look at the display on the instrument panel to see if the space has been detected as “appropriate” and if the correct position for parking has been reached » Fig. 203 B or » Fig. 204 B. The space is considered “appropriate” if the display on the instrument panel shows the message to park 5.
3.	Stop the vehicle and, after a brief pause, engage the reverse gear.
4.	Release the steering wheel » ⚠ in Introduction on page 232.

	Do the following:
5.	Please note the following message: Active automatic steering. Watch out around you. While you keep watch around you, carefully start accelerating up to no more than 7 km/h (4 mph). During the parking manoeuvre, the system only takes charge of the steering. You, as the driver, have to accelerate, engage the clutch if necessary, change gears and brake. Reverse until the ParkPilot continuous signal is heard. OR: reverse until the instrument panel displays the message to go forwards » Fig. 203 A 1 or » Fig. 204 A 1. OR: reverse until the instrument panel displays the message Park Assist finished. The progress bar 7 indicates the distance to cover » page 236.
6.	Press down the brake pedal until the Park Assist system has finished turning the steering wheel. OR: until the 8 symbol on the instrument panel display switches off.
7.	Select first gear.
8.	

	Do the following:
9.	Go forward until the ParkPilot continuous signal is heard. OR: go forward until the instrument panel display shows the message to reverse. The Park Assist system steers the vehicle forward and back until it centres it in the space » Fig. 203 C or » Fig. 204 C. For best results, wait at the end of each manoeuvre until the Park Assist system has finished turning the steering wheel.
10.	The parking manoeuvre ends when a corresponding message is displayed on the instrument panel and, in some cases, an acoustic signal sounds.
<p>i Note</p> <p>If the manoeuvre is terminated prematurely during parking, the result may not be the best.</p>	

Exiting a parking space with Park Assist (only for parallel spaces)

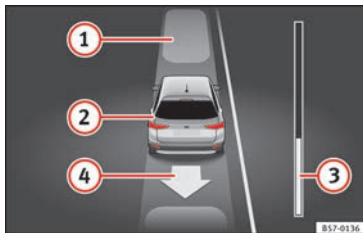


Fig. 205 On the instrument panel display: exiting a parallel parking space.

Key to the **Fig. 205**:

- ① Parked vehicle
- ② Your vehicle in reverse gear
- ③ Progress bar to indicate the distance left to cover
- ④ Message giving the proposed manoeuvre to exit the parking space

Necessary conditions to exit a parking space with Park Assist

- Only for parallel parking spaces
- The traction control system (ASR) must be turned on » page 174.
- Length of the space: **length of the vehicle + 0.5 metres**

- Do not exceed approximately **7 km/h (4 mph)** when exiting the parking space.

Exiting a parking space

Do the following:

For parallel parking spaces	
1.	The necessary conditions to exit a parking space with Park Assist have to be met » page 238.
2.	Switch on the engine » page 165.
	Press the button » Fig. 200.
3.	A control lamp on the button lights up when the system is switched on.
4.	Turn on the corresponding turn signal towards the road you will enter when exiting the parking space.
5.	Engage reverse gear or turn the selector lever to position R .
	Release the steering wheel » in Introduction on page 232.
	Please note the following message: Active automatic steering. Watch out around you.
6.	While you keep watch around you, carefully start accelerating up to no more than 7 km/h (4 mph).
	When exiting the parking space, the system only takes charge of the steering. You, as the driver, have to accelerate, engage the clutch if necessary, change gears and brake.

For parallel parking spaces	
	Reverse until the ParkPilot continuous signal is heard.
7.	OR: reverse until the instrument panel display shows the message to go forward.
	The progress bar » Fig. 205 ③ indicates the distance to cover » page 236.
	Press down the brake pedal until the Park Assist system has finished turning the steering wheel.
8.	OR: press down the brake pedal until the symbol on the instrument panel display switches off.
	Go forward until the ParkPilot continuous signal is heard.
9.	OR: go forward until the instrument panel display shows the message to reverse.
	The Park Assist system steers the vehicle forward and back until it can exit the space.
	The vehicle can exit the space when a corresponding message is displayed on the instrument panel and, in some cases, an acoustic signal sounds.
10.	Take charge of the steering with the turning angle set by the Park Assist system.
11.	Paying attention to the traffic, exit the parking space.

Automatic braking intervention by Park Assist

Park Assist helps the driver by automatically braking in certain situations.

The driver is always responsible for braking in time »» ⚠.

Automatic braking intervention to avoid exceeding the speed limit

To avoid exceeding the speed limit of approximately 7 km/h (4 mph) when entering or leaving a parking space, the brakes may activate automatically. After automatically activating the brakes, the manoeuvres to enter or exit a parking space may continue.

The brakes are only automatically activated once for each attempt to enter or exit a parking space. If the speed of approximately 7 km/h (4 mph) is exceeded again, the corresponding operation is halted.

Automatic braking to reduce damages

Depending on certain conditions, the Park Assist system can automatically brake the vehicle when faced with an obstacle, briefly actuating and holding down the brake pedal »» ⚠. Following this the driver must press the brake pedal.

Automatic braking intervention to reduce damage leads to the parking manoeuvre finishing.

⚠ WARNING

The automatic braking intervention by Park Assist should never tempt you to take any risk that may compromise safety. The system is not a replacement for driver awareness.

- The Park Assist system is subject to certain limitations inherent to the system. In certain situations, the automatic braking intervention may only work in a limited way or not work at all.
- Always be ready to use the brakes yourself!
- The automatic braking intervention will end after approximately 1.5 seconds. Following this, brake the vehicle yourself.

Parking System Plus (ParkPilot)*

Description

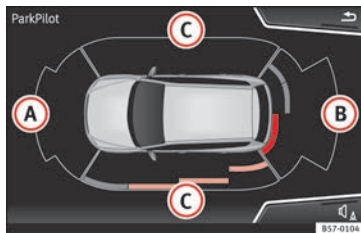


Fig. 206 Represented area.

During parking, **Parking System Plus** assists the driver by visually and audibly warning them about obstacles detected *in front of and behind* the vehicle.

There are ultrasound sensors integrated in the front and rear bumpers. When they detect an obstacle, you are alerted by audible warnings and visually on the Easy Connect system.

In the event of danger of a frontal collision, the audible warnings come from the front of the vehicle, and in the event of the danger of a rear-end collision they come from the rear.

Make particularly sure that the sensors are not covered by adhesives, residues and the like, as this could affect the system's operation. Cleaning instructions »» page 268.

The approximate measurement range of the sensors is:

- Ⓐ 1.20 m
- Ⓑ 1.60 m
- Ⓒ 0.90 m

As you approach the obstacle, the time interval between the audible warnings will be reduced. When you reach around 0.30 m the warning will be constant: do not continue to move forward (or backward)!

If you maintain separation from the obstacle, the volume of the warning begins to reduce »»

after four seconds (does not affect the tone of the constant warning).

In order to view the entire periphery of the vehicle, the vehicle must be moved a few metres forwards and backwards. Thus the missing areas are screened and the periphery of the vehicle is calculated.

Special features of ParkPilot with Area View

In the following situations the screened area on the side of the vehicle is automatically hidden:

- When a vehicle door is opened.
- When the ASR is switched off.
- When there is ASR or ESC regulation.
- If the vehicle remains stationary for more than approximately 3 minutes.

WARNING

- Always pay attention, also when looking straight ahead, to traffic and the vehicle surroundings. The assistance systems are not a replacement for driver awareness. When inserting or removing the vehicle from a parking space, or when performing similar manoeuvres the driver always assumes the responsibility.
- Adapt your speed and driving style at all times to suit visibility, weather, road and traffic conditions.

- The ultrasound sensors have blind spots in which obstacles and people are not registered. Pay special attention to children and animals.
- Always keep visual control of the vehicle surroundings: use the mirrors for additional help.

CAUTION

Parking Aid functions may be negatively affected by different factors that may lead to damage to the vehicle or its immediate surroundings:

- Under certain circumstances, the system does not detect or display certain objects:
 - Objects such as chains, trailer draw bars, fences, posts and thin trees.
 - Objects that are located above the sensors, such as protrusions in a wall.
 - Objects with certain surfaces or structures, such as wire mesh fences or powder snow.
- Certain surfaces of objects and garments do not reflect the ultrasound sensors' signals. The system cannot detect these objects or people wearing such clothes correctly.
- Ultrasound sensor signals may be affected by external sound sources. In certain circumstances this may prevent them from detecting people or objects.
- Please note that low obstacles detected by the system may no longer be registered by

the sensors as the car moves closer, so the system will not give any further warning. In certain circumstances, objects such as high kerbs that could damage the bottom of the vehicle are not detected either.

- If the first warning from the ParkPilot is ignored, the vehicle could suffer considerable damage.
- The knocks or damage on the radiator grille, bumper, wheel arch and vehicle underbody can adjust the orientation of the sensors. This can affect the parking aid function. In this case, have the function checked by a specialised workshop.
- A registration plate or plate holder on the front with larger than the space for the registration plate, or a registration plate that is curved or warped can cause:
 - false detections,
 - loss of sensor visibility.

Note

- In certain situations, the system can give a warning even though there is no obstacle in the detected area, e.g:
 - with rough or cobbled floors or ground with long grass;
 - with external ultrasound sources, such as cleaning vehicles or other vehicles equipped with ultrasound systems;
 - in downpours, intense snow, hail or dense exhaust gases,

- if the number plate is not perfectly secured to the bumper surface,
- or in locations such as the brow of a hill.
- In order to guarantee good system operation, keep the ultrasound sensors clean, free of snow or ice, and do not cover them with adhesives or other objects.
- If you use high-pressure or vapour equipment to clean the ultrasound sensors, apply it directly only very briefly and always from a distance of more than 10 cm.
- Retrofitting of accessories to the vehicle, such as a bicycle rack, may interfere with the operation of the Parking Aid.
- Fitting certain accessories to the front of the vehicle, such as a plate holder with advertising, may interfere with the operation of the Park Assist.
- In order to familiarise yourself with the system, it is advised that you practice parking in an area or car park that is free from traffic. There must be good weather and light conditions.
- The volume and tone of the warnings can be modified, in addition to the indications » page 246.
- In vehicles *without* an infotainment system, these parameters can be modified in a SEAT Official Service or in a specialised workshop.
- Please observe information on towing a trailer » page 247.
- The display on the Easy Connect screen shows a slight time delay.

Parking Aid operation

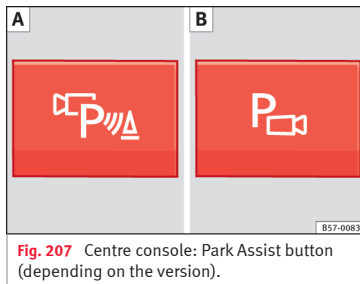


Fig. 207 Centre console: Park Assist button (depending on the version).

Manual connection of Parking Aid

- Press the **P** button *once*.

Manual disconnection of Parking Aid

- Press the **P** button *again*.

Manual disconnection of Parking Aid display (the audible sounds remain active)

- Press a button on the main menu of the factory-assembled infotainment system.
- **OR:** Press the **BACK** function button.

Automatic connection of Parking Aid

- Engage reverse gear or turn the selector lever to position **R**.
- **OR:** If the vehicle approaches an obstacle that is in its forwards path at a speed below

10 km/h (6 mph) » page 242. The obstacle is detected as of a distance of approx. 95 cm if the automatic connection is activated in the infotainment system. A reduced display is shown.

Automatic disconnection of Parking Aid

- Move the selector lever to position **P**.
- **OR:** accelerate to more than approx. 10 km/h (6 mph) forward.

Temporary suppression of sound in Parking Aid

- Press the **🔇** function button.

Change from reduced view to full view

- Engage reverse gear or turn the selector lever to position **R**.
- **OR:** press the car icon in reduced view.

If necessary, switch to the rear-assist image (Rear View Camera "RVC")

- Engage reverse gear or turn the selector lever to position **R**.
- **OR:** Press the **RVC** function button.

A short confirmation signal will be heard and the button symbol will light up yellow when the system is switched on.

Automatic activation



Fig. 208 Miniature indication of automatic activation

When the Parking System Plus is switched on automatically, a miniature of the vehicle will be displayed and the segments will be shown on the left side of the screen

» **Fig. 208.**

Automatic activation occurs when slowly approaching an obstacle located in front of the vehicle. It only operates every time the speed is reduced below approximately 10 km/h (6 mph) for the first time.

If the parking aid is switched off using the **P** button, the following actions must be carried out in order for it to automatically switch on:

- Switch off the ignition and switch it on again.

- **OR:** accelerate above 10 km/h (6 mph) before reducing speed below this number again.

- **OR:** place the selector lever in position **P** and then move it from this position.
- **OR:** switch on and off the automatic activation in the Easy Connect system menu.

The automatic activation with parking aid miniature indication can be switched on and off from the Easy Connect system menu

» **Fig. 26:**

- Switch the ignition on.
- Select: **CAR** button > **Settings** > **Parking and manoeuvring.**
- Select the **Automatic activation** option. When the function button check box is activated , the function is on.

If the system has been activated automatically, an audible sound warning will only be given when obstacles in front are at a distance of less than 50 cm.

ⓘ CAUTION

The automatic connection of the Parking Aid only works when you are driving slowly. If driving style is not adapted to the circumstances, an accident and serious injury or damage may be caused.

Segments of the visual indication

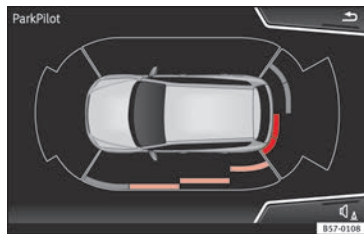


Fig. 209 Parking Aid display on the Easy Connect system screen.

The distance of separation from the obstacle can be estimated using the segments around the vehicle.

The optical indication of the segments works as follows:



White segments: a white segment is displayed when the obstacle is not within the vehicle's trajectory or the direction of travel is in the opposite direction to its location.

Yellow segments: obstacles located in the vehicle's trajectory and which are more than 30 cm away from the vehicle are displayed in yellow.

Red segments: obstacles that are less than 30 cm away from the vehicle are displayed in red.

Moreover, with the SEAT Media System Plus/Navi System radios, a yellow trail indicates the vehicle's expected trajectory based on the steering wheel angle.

Whenever the obstacle is located in the vehicle's direction of travel, the corresponding audible warning will sound.

As the vehicle approaches an obstacle, the segments are displayed closer to the vehicle. When the penultimate segment is displayed, this means that the vehicle has reached the collision zone. In the collision zone, the obstacles are represented in red, including those out of the path. Do not continue to move forward (or backward) »  in Description on page 240, »  in Description on page 240 !

In the event the car is equipped with the Area View system, visual indication of Park Assist will appear depending on the selected view in the Area View system.

Adjusting the display and audible warnings

The settings for the display and audible warnings are controlled via the Easy Connect*.

Automatic activation

on – activates the **Automatic activation** option » page 242.

off – deactivates the **Automatic activation** option » page 242.

Front volume*

Volume in the front and rear area.

Front sound settings/sharpness*

Frequency (tone) of the sound in the front area.

Rear volume*

Volume in the rear area.

Rear sound settings/sharpness*

Frequency (tone) of the sound in the rear area.

Adjust volume

With the parking aid switched on, the active audio/video source volume will be reduced to the intensity of the selected setting.






Error messages

When the Parking Aid is activated or when it is switched on, if a message reporting a Park-

ing aid error is displayed on the instrument panel, there is a fault in the system.

If the fault doesn't disappear before disconnecting the ignition, next time that parking aid is engaged in reverse, it will not be indicated.

If there is a fault in the parking aid system a message will appear on the instrument panel indicating the error. In addition the P_{va} key LED will blink.

If there is a fault in a sensor, the symbol  is displayed on the Easy Connect display in front of/behind the vehicle. If a rear sensor is faulty, only the obstacles in the areas  and  are displayed » Fig. 206. If a front sensor is faulty, only the obstacles in the areas  and  are displayed.

Have the fault corrected by a specialised workshop without delay.

Driving with a trailer

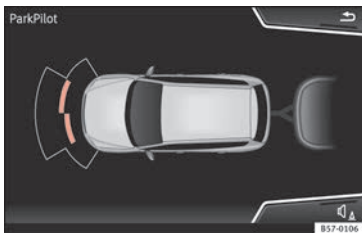


Fig. 210 ParkPilot display on the screen with trailer attached.

In vehicles equipped with a towing bracket device from the factory, when the trailer is connected electrically, the Parking Aid rear sensors will not be activated when reverse gear is engaged, when the selector lever is turned to position **R** or when the button **P** is pressed.

The distance to possible obstacles at the rear of the vehicle and at its sides will not be displayed on the screen and will not be indicated by means of audible sound signals.

The Easy Connect system screen will only display objects detected at the front, and the vehicle's trajectory will be hidden.

Parking aid (ParkPilot)*

Description

Various systems are available to help you when parking or manoeuvring in tight spaces, depending on the equipment fitted on your vehicle.

The **rear parking aid** is an audible assistant that warns of obstacles located *behind* the vehicle.

There are sensors integrated in the rear bumper. When they detect an obstacle, you are alerted by audible warnings and visually on the Easy Connect system.

If the Area View system is installed, the rear parking aid will issue an audible warning about objects near the rear of the vehicle, and the Area View image will be available on the Easy Connect screen, giving a real image of the objects around the car.

Make particularly sure that the sensors are not covered by adhesives, residues, dirt and the like, as this could affect the system's operation. Cleaning instructions » page 268.

The approximate measurement range of the rear sensors is:

side area	0.60 m
central area	1.60 m

As you approach the obstacle, the time interval between the audible warnings will be reduced. When you reach around 0.30 m the warning will be constant: Do not continue to move forward (or backward) » » **Δ**, » » **!**

If you maintain separation from the obstacle, the volume of the warning begins to reduce after four seconds (does not affect the tone of the constant warning).

Activating/Deactivating

When engaging reverse gear, the parking aid is automatically switched on. This is confirmed with a short warning.

On disengaging reverse gear, the parking aid system is switched off.

⚠ WARNING

- **Always pay attention, also when looking straight ahead, to traffic and the vehicle surroundings. The assistance systems are not a replacement for driver awareness. When inserting or removing the vehicle from a parking space, or when performing similar manoeuvres the driver always assumes the responsibility.**
- **Adapt your speed and driving style at all times to suit visibility, weather, road and traffic conditions.**

- The ultrasound sensors have blind spots in which obstacles and people are not registered. Pay special attention to children and animals.
- Always keep visual control of the vehicle surroundings: use the mirrors for additional help.

ⓘ CAUTION

Parking Aid functions may be negatively affected by different factors that may lead to damage to the vehicle or its immediate surroundings:

- Under certain circumstances, the system does not detect or display certain objects:
 - Objects such as chains, trailer draw bars, fences, posts and thin trees.
 - Objects that are located above the sensors, such as protrusions in a wall.
 - Objects with certain surfaces or structures, such as wire mesh fences or powder snow.
- Certain surfaces of objects and garments do not reflect the ultrasound sensors' signals. The system cannot detect these objects or people wearing such clothes correctly.
- Ultrasound sensor signals may be affected by external sound sources. In certain circumstances this may prevent them from detecting people or objects.
- Please note that low obstacles detected by the system may no longer be registered by

the sensors as the car moves closer, so the system will not give any further warning. In certain circumstances, objects such as high kerbs that could damage the bottom of the vehicle are not detected either.

- If the first warning from the ParkPilot is ignored, the vehicle could suffer considerable damage.
- The knocks or damage on the radiator grille, bumper, wheel arch and vehicle underbody can adjust the orientation of the sensors. This can affect the parking aid function. In this case, have the function checked by a specialised workshop.

ⓘ Note

- In certain situations, the system can give a warning even though there is no obstacle in the detected area, e.g:
 - with rough or cobbled floors or ground with long grass;
 - with external ultrasound sources, such as cleaning vehicles or other vehicles equipped with ultrasound systems;
 - in downpours, intense snow, hail or dense exhaust gases,
 - if the number plate is not perfectly secured to the bumper surface,
 - or in locations such as the brow of a hill.
- In order to guarantee good system operation, keep the ultrasound sensors clean, free

of snow or ice, and do not cover them with adhesives or other objects.

- If you use high-pressure or vapour equipment to clean the ultrasound sensors, apply it directly only very briefly and always from a distance of more than 10 cm.
- Retrofitting of accessories to the vehicle, such as a bicycle rack, may interfere with the operation of the Parking Aid.
- In order to familiarise yourself with the system, it is advised that you practice parking in an area or car park that is free from traffic. There must be good weather and light conditions.
- The volume and tone of the warnings can be modified, in addition to the indications »» page 246.
- In vehicles *without* an infotainment system, these parameters can be modified in a SEAT Official Service or in a specialised workshop.
- Please observe information on towing a trailer »» page 247.
- The display on the Easy Connect screen shows a slight time delay.

Parking Aid operation

Manual disconnection of Parking Aid display (the audible sounds remain active)

- Press a button on the main menu of the factory-assembled infotainment system.
- **OR:** Press the **BACK** function button. »»


Parking Aid connection

- Engage reverse (for manual gears) or set the selector lever to **R** (for automatic gears).

Parking Aid disconnection

- Place the selector level in position **P**, **N** or **D** (for automatic gearboxes) or disengage reverse (for manual gearboxes). If you set the lever to **N** or **D**, the system will remain active for approximately 8 seconds before switching off, except with Area View, when it will be switched off immediately after engaging reverse.

Temporary suppression of sound in Parking Aid

- Press the  function button. If you have the Area View system installed you cannot use the temporary suppression of sound in Parking Aid.

Switch from reduced to full-screen view if the rear assist is fitted (Rear View Camera “RVC”)

- Press the car icon in the reduced view.

If necessary, switch to the rear-assist image (Rear View Camera “RVC”)

- Engage reverse gear or turn the selector lever to position **R**.
- OR**: press the **RVC** function icon.

Segments of the visual indication

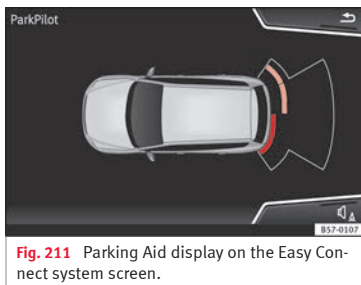


Fig. 211 Parking Aid display on the Easy Connect system screen.

The distance to the obstacles can be estimated with the help of the segments at the rear of the vehicle.



The optical indication of the segments works as follows:

White segments: they are displayed if the obstacle is not in the vehicle's direction of travel, even when the electric parking brake is activated.

Yellow segments: obstacles located in the vehicle's trajectory and which are more than 30 cm away from the vehicle are displayed in yellow.

Red segments: obstacles that are less than 30 cm away from the vehicle are displayed in red.

Whenever the obstacle is located in the vehicle's direction of travel, the corresponding audible warning will sound.

As the vehicle approaches an obstacle, the segments are displayed closer to the vehicle. When the penultimate segment is displayed, this means that the vehicle has reached the collision zone. In the collision zone, the obstacles are represented in red, including those out of the path. Do not continue to reverse **»»**  in Description on page 244, **»»**  in Description on page 245!

If you are equipped with Area View

Segments are not displayed when the vehicle is equipped with Area View.

The PDC system will issue an audible warning for objects that are near the rear of the vehicle, and the Area View image will be available on the screen, giving a real image of the objects around the car.

Adjusting the display and audible warnings

The settings for the display and audible warnings are controlled via the Easy Connect*.

Rear volume*

Volume in the rear area.

Rear sound settings/sharpness*

Frequency (tone) of the sound in the rear area.


Adjust volume

With the parking aid switched on, the active audio/video source volume will be reduced to the intensity of the selected setting.

Error messages

When the Parking Aid is activated or when it is switched on, if a message reporting a Parking aid error is displayed on the instrument panel, there is a fault in the system.

If the fault disappears before disconnecting the ignition, next time that parking aid is engaged in reverse it will not be indicated.

If there is a fault in a sensor, the  symbol is displayed on the Easy Connect display.

Have the fault corrected by a specialised workshop without delay.

Towing bracket

In vehicles equipped with a towing bracket device from the factory, when the trailer is connected electrically, the Parking Aid rear sensors will not be activated when reverse gear is engaged (manual gears) nor when the

selector lever is turned to position **R** (automatic gears).

Area View*

Introduction

 » table on page 2

Using 4 cameras, the system generates a representation that is shown on the infotainment system display. The cameras are located on the radiator grille, the exterior mirrors and the rear lid.

The functions and representations of the Area View system may vary depending on whether or not the vehicle has ParkPilot.

WARNING

The image from the cameras does not make it possible to calculate the distance to the obstacles (people, vehicles, etc.) precisely, so using them could cause serious accidents and injury.

- The camera lenses augment and distort the visual field and the objects on the screen are seen differently and imprecisely.
- Certain objects may not be shown or may not be shown very clearly, for example, posts or thin rails, due to the screen resolution or if light conditions are insufficient.

- The cameras have blind spots in which obstacles and people are not registered.
- The camera lens must be kept free, without snow or ice, and should not be covered.

WARNING

The smart technology incorporated into the Area View system cannot overcome the limits imposed by the laws of physics and it only works within the limits of the system. The greater convenience provided by the Area View system should never tempt you to take any risk that may compromise safety. If used negligently or involuntarily, it may cause serious accidents and injuries. The system is not a replacement for driver awareness.

- Adapt your speed and driving style to suit visibility, weather, road and traffic conditions.
- Do not be distracted from the traffic by looking at the screen.
- Monitor the area around the vehicle at all times, since the cameras do not capture small children, animals and certain objects in all situations.
- The use of a number plate may interfere in the views shown on the screen, since the cameras' field of vision may be reduced.
- The system will probably be unable to represent all areas clearly.

ⓘ CAUTION

- The camera images are only two-dimensional. Due to a lack of spatial depth, objects that jut out or holes on the road, for example, are more difficult to detect or may not be seen at all.
- In certain circumstances, the camera does not capture objects such as beams, fences, posts or thin trees, which could damage the vehicle.
- The system displays the auxiliary lines and boxes regardless of the vehicle's environment, no objects are detected. The driver is responsible for determining that the vehicle will fit in the parking space.

ⓘ CAUTION

- In order to guarantee good system operation, keep the cameras clean, free of snow or ice, and do not cover them with adhesives or other objects.
- Never use abrasive cleaning products to clean the camera lenses.
 - Do not use hot or warm water to remove ice or snow from the camera lenses. Doing so could damage the lenses.

Area View system

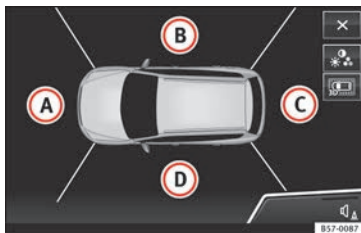


Fig. 212 Display of the Area View system: aerial view.

There are four different views to choose from:

Key to the Fig. 212:

Symbol	Meaning
A	Front camera area
B	Right camera area
C	Rear camera area
D	Left camera area
X	Exit the current display.
	Three-dimensional views
	Depending on the equipment: connecting and disconnecting the ParkPilot sound.

Key to the Fig. 212:

Symbol	Meaning
	Setting the display: brightness, contrast and colour.

The aerial view is generated by combining the images from all the cameras **» Fig. 212**. The aerial view can be selected by pressing the *vehicle* in the area.












Select the corresponding view by pressing the different areas **» Fig. 212** **A** to **D** of the aerial view or the reduced aerial view.

Conditions necessary for the use of the Area View system


- The doors and the rear lid must be closed.
- The image must be reliable and clear. For this reason, for example, the camera lens must be clean.
- The area around the vehicle must be clearly and totally visible.
- The area for parking or manoeuvring should be a flat surface.
- The vehicle should **not** be loaded very heavily at the rear.
- The driver must be used to the system.
- There should be no damage to the vehicle in the camera area. If the position or installation angle of the cameras have been changed, e.g. after a rear-end collision, the

system should be checked by a specialised workshop.

Camera image view

- **Aerial view (bird's eye view):** to obtain a panoramic view of the vehicle , three-dimensional views, from different camera positions.
- **Front Camera (front view):** to observe traffic ahead of the vehicle (vehicles crossing) , for front parallel parking , when approaching an obstacle and in off-road driving .
- **Side cameras (side view):** to view the area close to the sides of the vehicle, both on the left  and on the right , or a combination of both sides .
- **Rear camera (rear view):** To observe traffic behind the vehicle (vehicles crossing) , for reverse perpendicular parking , for reverse parallel parking  and for hitching a trailer to the vehicle .

The selected view is displayed on the right side of the screen. The reduced aerial view shown on the right side displays the view framed in yellow. In addition, the right margin of the screen displays the menu options possible and the views (the so-called “modes”) of the camera in question. The active view (mode) at the time is highlighted.

The reduced aerial view can be hidden by pressing the  symbol to thus display the selected view full-screen.

Instructions for use

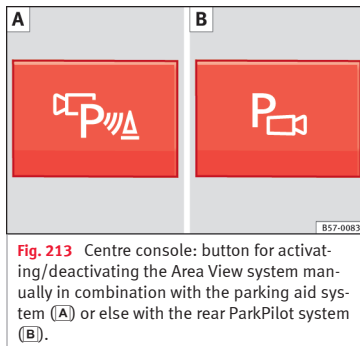







Fig. 213 Centre console: button for activating/deactivating the Area View system manually in combination with the parking aid system (A) or else with the rear ParkPilot system (B).

Connecting and disconnecting the Area View system

Manual connection of the display:	Press the  button »» Fig. 213 once.
	The infotainment system screen displays the aerial view »» Fig. 212 . If you press the  button when driving above 15 km/h (9 mph), the image will not be displayed.
Automatic connection of the display:	Select reverse gear.
	The view of the image of the vehicle's rear camera is shown in parallel parking mode with the reduced aerial view.

Connecting and disconnecting the Area View system

Manual disconnection of the display:	Press the  button »» Fig. 213 again.
	OR: press a button on the factory-equipped infotainment system, for example the  button.
	OR: press the function button  .
Automatic disconnection of the display:	Drive forward at more than approx. 15 km/h (9 mph).
	OR: switch the ignition off. The Area View system menu disappears immediately.

Special characteristics

Examples of optical illusions caused by the cameras:

The images on the area view system cameras are only two-dimensional. Due to a lack of spatial depth, it is difficult or impossible to make out on-screen any holes there may be on the ground, objects jutting out from the ground or parts protruding from other vehicles.

Situations in which the objects or other vehicles appear to be further away or closer than they really are:

- On moving from a horizontal plane to a slope.
- On moving from a slope to a horizontal plane.
- If the vehicle is heavily loaded at the rear. **»»**

Examples of optical illusions caused by the cameras:

– If the vehicle approaches protruding objects. These objects may be outside the cameras' angle of visibility.

Trailer mode

The Area View system conceals, in the rear camera area, all the auxiliary guiding lines when the factory-fitted towing bracket is connected electrically to a trailer » page 255.

Note

In order to become familiar with the system and its functions, SEAT recommends that you practice handling the Area View system in an area where there is not too much traffic or in a car park.

Menus of the Area View system (modes)

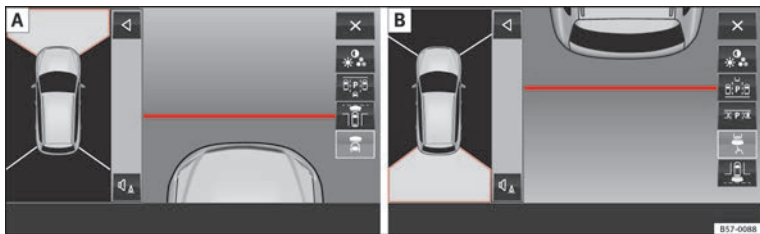


Fig. 214 Display on the Area View system screen: **A** Front camera: off-road view **B** Rear camera: off-road view

Key to the Fig. 214:

Symbol	Meaning
	Depending on the equipment: connecting and disconnecting the ParkPilot sound.
	Showing the reduced display.
	Hiding the reduced display.
	Exiting the Area View system screen:




Key to the Fig. 214:

Symbol	Meaning
	Setting the display: brightness, contrast and colour.

Aerial views (bird's eye view)



View	On-screen display of all cameras
Main mode	The vehicle and its immediate vicinity seen from above are shown. Depending on the equipment, the ParkPilot's path may also be displayed.


Driver assistance systems

View	On-screen display of all cameras	
Three-dimensional views		The vehicle and its vicinity seen from above are shown.
		The vehicle and its vicinity seen from above are shown obliquely.
		The vehicle and its vicinity seen obliquely are shown.




Swipe the infotainment system display with your finger in the direction of the arrows to change the angle of vision in the three-dimensional views of the vehicle and its vicinity.

Front camera views (front view)




View	On-screen display of the front camera
Cross traffic at the front 	Left area of the screen: street to the left.
	Central area of the screen: area directly in front of the vehicle. Right area of the screen: street to the right.
Parallel parking 	The area in front of the vehicle is shown. Orientation lines are shown to give guidance.


View	On-screen display of the front camera
Off-road 	The area directly in front of the vehicle seen from above is shown. For example, on a slope, in order to see the area directly in front of the vehicle. The red line is shown at a distance of approx. 0.4 m from the vehicle.

Side camera views (side view)

View	On-screen display of the side cameras
Right and left sides 	The areas located directly to the side of the vehicle seen from above are represented in order to navigate possible obstacles more precisely. The orange auxiliary lines are shown at a distance of approx. 0.4 m from the vehicle.
Left side 	The area directly next to the vehicle, on the driver's or front passenger's side, is displayed, and the blind spots all along the vehicle can be seen. The orange auxiliary line is shown at a distance of approx. 0.4 m from the vehicle.
Right side 	

Rear camera views (rear view)

View	On-screen display of the rear camera
Parallel parking 	The area behind the vehicle is shown. Auxiliary lines are shown to give guidance.
Parallel parking 	The vehicle's initial position on initiating this function will be a decisive factor in determining the place where the manoeuvre executed by the assistant will end.
Off-road or hitching a trailer function 	The vehicle's rear is presented. The red auxiliary line establishes the safety distance.
	Green and red semicircular auxiliary lines are displayed in vehicles with a factory-fitted towing bracket. The auxiliary lines indicate the distance from the towing bracket. The distance between the auxiliary lines (green and red) is approx. 0.3 m. The orange auxiliary line indicates, depending on the turn of the steering wheel, the pre-calculated direction of the towing bracket.
	In vehicles with a factory-fitted towing bracket, the distance from the red auxiliary line to the vehicle is approx. 0.4 m. No other auxiliary line is displayed. »

View	On-screen display of the rear camera
Cross traffic at the rear 	Left area of the screen: street to the left.
	Central area of the screen: area directly behind the vehicle.
	Right area of the screen: street to the right.

Rear Assist (Rear View Camera)*

Operating and safety warnings

WARNING

- The Rear Assist does not make it possible to precisely calculate the distance from obstacles (people, vehicles, etc.) and nor can it overcome the system's own limits, hence using it may cause serious accidents and injuries if used negligently or without due care. The driver should be aware of his/her surroundings at all times to ensure safe driving.
- The camera lens expands and distorts the field of vision and displays the objects on the screen in a different, vague manner. The perception of distances is also distorted by this effect.
- Some objects may, due to the resolution of the display screen - not be displayed in a satisfactory manner or may not be displayed at

all. Take special care with thin posts, fences, railings or trees that might not be displayed on screen and could damage the vehicle.

- The rear assist has blind spots where it is not possible to represent people or objects (small children, animals and certain objects cannot be detected in its field of vision). Monitor the vehicle's surrounding area at all times.
- Keep the camera lens clean, free of ice and snow, and do not cover it.
- The system is not a replacement for driver awareness. Supervise the parking operation at all times, as well as the vehicle's surrounding area. Adapt your speed and driving style at all times to suit visibility, weather, road and traffic conditions.
- Do not be distracted from the traffic by looking at the screen.
- The images on the rear assist screen are only two-dimensional. Due to a lack of spatial depth, protruding parts or holes in the road, for example, are more difficult to detect or may not be seen at all.
- Vehicle load modifies the representation of the orientation lines displayed. The width represented by the lines diminishes with vehicle load. Pay special attention to the vehicle's surroundings when the inside of the vehicle of the luggage compartment is carrying a heavy load.
- In the following situations, the objects or other vehicles shown in the navigation system display appear to be further away or

closer than they really are: Pay special attention:

- On moving from a horizontal plane to a slope.
- On moving from a slope to a horizontal plane.
- If the vehicle is heavily loaded at the rear.
- When the vehicle approaches objects that are not on the ground surface or are jutting out from it. These objects may also be outside the camera's angle of vision when reversing.

Note

- It is important to take great care and pay special attention if you are not yet familiar with the system.
- Rear assist will not be available if the vehicle's rear lid is open.

Instructions for use

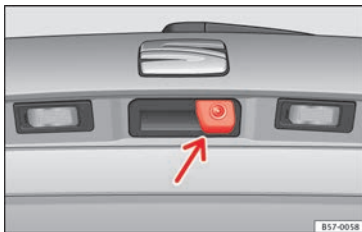


Fig. 215 In the rear lid handle: location of the rear assist camera


A camera installed in the rear lid handle assists the driver in reverse parking or manoeuvring » **Fig. 215**. The camera image is viewed together with orientation lines projected by the system on the Easy Connect system screen. The bottom of the screen displays part of the bumper corresponding to the number plate area that will be used as reference by the driver.

Rear assist settings:

Rear assist offers the user the possibility to change the image's *brightness, contrast* and *colour* settings.

To change these settings:

- Park the vehicle in a safe place.
- Apply the parking brake.

- Switch the ignition on.
- If necessary, switch on the Easy Connect system.
- Engage reverse gear or turn the selector lever to position **R**.
- Press the  function button displayed on the right of the image.
- Make the desired adjustments on the menu by pressing the $-/+$ function buttons or by moving the corresponding scroll button.

Necessary conditions for parking and manoeuvring with the

The system should not be used in the following cases:

- If the image displayed is not very reliable or is distorted, for example low visibility or dirty lens.
- If the area behind the vehicle is not displayed very clearly or is incomplete.
- If the vehicle is heavily loaded at the rear.
- If the position and installation angle of the camera have been changed, e.g. after a rear-end collision. Have the system checked by a specialised workshop.

Familiarising yourself with the system

To familiarise yourself with the system, the orientation lines and their function, SEAT recommends practising parking and manoeuvring with the rear assist in a place without

too much traffic or in a car park when there are good weather and visibility conditions.

Cleaning the camera lens

Keep the camera lens clean and clear of snow and ice:

- Moisten the lens using a normal alcohol-based glass cleaning product and clean the lens with a dry cloth.
- Remove snow using a small brush.
- Use de-icing spray to remove any ice.

ⓘ CAUTION

- **Never use abrasive cleaning products to clean the camera lens.**
- **Do not use hot or warm water to remove ice or snow from the camera lens. Doing so could damage the camera.**

Parking and manoeuvring with the rear assist

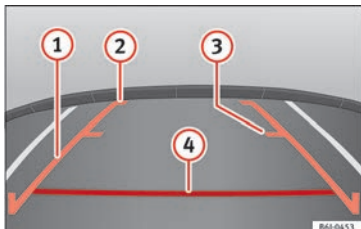


Fig. 216 Display on the Easy Connect system screen: orientation lines.

Switching the system on and off

- The rear assist will switch on when the ignition is on or the engine running, on engaging reverse gear (manual gearbox) or on changing the selector lever to the **R** position (automatic gearbox).
- The system switches off 8 seconds after disengaging reverse gear (manual gearbox) or removing the selector lever from the **R** position (automatic gearbox). The system will also disconnect immediately after the ignition is switched off.

- The camera will stop transmitting images above the speed of 15 km/h (9 mph) with reverse engaged.

In combination with the Parking System Plus » page 244, the camera image will cease to be transmitted immediately when reverse gear is disengaged or when the selector lever is moved from the **R** position, and the optical information provided by the Parking Aid system will be displayed.

Also in combination with the system, the rear assist image can also be concealed:

- By pressing one of the Infotainment system buttons on the display.
 - OR: By pressing the miniature vehicle that appears on the left of the screen (which switches to the full-screen mode of the Parking System Plus's optical system).
- If you wish to display the rear assist image again:
- Disengage reverse, or change the selector lever's position, engage reverse again or move the selector lever to position **R**.
 - OR: Press the **RVC** function button¹⁾

Meaning of the orientation lines

» Fig. 216

- 1 **Side lines:** extension of the vehicle (the approximate width of the vehicle plus the rear view mirrors) on the road surface.
- 2 **End of the side lines:** the area marked in green ends approximately 2 m behind the vehicle on the road surface.
- 3 **Intermediate line:** indicates a distance of approximately 1 m behind the vehicle on the road surface.
- 4 **Red horizontal line:** indicates a safe distance of approximately 40 cm at the rear of the vehicle on the road surface.

Parking manoeuvre

- Place the vehicle in front of the parking space and engage reverse gear (manual gearbox) or move the selector to the **R** position (automatic gearbox).
- Reverse slowly, and turn the steering wheel so that the side orientation lines lead towards the parking space.
- Guide the vehicle into the parking space so that the side orientation lines run parallel to it.

¹⁾ **WARNING:** the **RVC** function button will only be activated and available when the reverse gear is engaged or the selector lever is set to position **R**.

Towing bracket device*

Trailer mode

Introduction

Take into account country-specific regulations about driving with a trailer and the use of a towing bracket.

The vehicle has been developed primarily for carrying people, although it can also be used to tow a trailer if fitted with the corresponding technical equipment. This additional load has an effect on the useful life, fuel consumption and vehicle performance and in some cases can reduce the service intervals.

Driving with a trailer requires more force from the vehicle, and thus more concentration from the driver.

In winter, winter tyres should be fitted on both the vehicle **and** the trailer.

Maximum vertical load technically permissible on the coupling

The *maximum* vertical load technically permitted from the trailer draw bar on the towing bracket's tow hitch is **85 kg**.

Vehicles with the Start-Stop system

If the vehicle has a factory-fitted towing bracket or one that is retrofitted by SEAT, the

Start-Stop system operates as normal. No special characteristics need to be taken into account.

If the system does not recognise the trailer or the trailer bracket has not been retrofitted by SEAT, the Start-Stop system must be disconnected by pressing the corresponding button in the lower part of the centre console before driving with the trailer, and it should remain off for the rest of the journey »» » ⚠.

Vehicles with driving profile selection

If you are going to be towing a trailer, the use of the **Eco** driving profile is not recommended. You are advised to select another of the available driving profiles before beginning to drive with a trailer.

⚠ WARNING

Never use the trailer to transport people, since it would put their life in danger and is also prohibited.

⚠ WARNING

Undue use of the towing bracket may cause injury and accidents.

- Only use the towing bracket if it is in a perfect state of repair and is properly secured.
- Never modify or repair the towing bracket in any way.
- In order to reduce the danger of injury in the event of rear-end collisions and to avoid

injury to pedestrians and cyclists when parking the vehicle, cover or remove the tow hitch when you are not using a trailer.

- Never fit a towing bracket "with weight distribution" or "load compensation". The vehicle has not been designed for this type of towing bracket. The towing bracket could fail and the trailer could be released from the vehicle.

⚠ WARNING

Driving with a trailer and transporting heavy or large objects can affect driving properties and even cause an accident.

- Always secure the load properly using belts or straps that are suitable and in good condition.
- Adapt your speed and driving style at all times to suit visibility, weather, road and traffic conditions.
- Trailers with a high centre of gravity are more likely to overturn than those with a low one.
- Avoid sudden braking and manoeuvres.
- Take great care when overtaking.
- Reduce speed immediately if you notice that the trailer is swaying, however slightly.
- Never drive at more than 80 km/h (50 mph) when towing a trailer (or at more than 100 km/h (60 mph) in exceptional circumstances). This also applies in countries where driving at higher speeds is permitted. Take

into account the speed limit for vehicles with trailers in the corresponding country, as it could be less than the speed limit for vehicles without a trailer.

- Never attempt to “straighten” the towing vehicle and trailer while accelerating.

WARNING

If the towing bracket has been retrofitted by a non-SEAT workshop, the Start-Stop system must be disconnected manually whenever driving with a trailer. Otherwise the brake system could be damaged and could consequently cause a serious accident or injury.

- Always disconnect the Start-Stop system manually when using a towing bracket that has not been fitted by a SEAT workshop.

Note

- Before hitching or unhitching a trailer, always deactivate the anti-theft alarm »» page 112. Otherwise, the tilt sensor could cause the alarm to go off.
- Do not drive with a trailer for the engine's first 1000 km »» page 184.
- SEAT recommends that, if possible, the tow hitch be disassembled or covered when it is not going to be used. In the event of a rear-end collision, the damage to the vehicle could be greater if the bracket is fitted.
- Some retrofitted towing brackets cover the rear towing eye. In these cases, the towing

eye should not be used for tow-starting or for towing other vehicles. For this reason, if the vehicle has been retrofitted with a towing bracket, always keep the tow hitch in the vehicle when you disassemble it.

Control lamp



The tow hitch is not securely locked in position.

Check that the towing bracket is locked »» page 257.

Some warning and control lamps will light up briefly when the ignition is switched on to check certain functions. They will switch off after a few seconds.

WARNING

If the warning lamps and the corresponding messages are ignored when they light up, the vehicle may stall in traffic and cause accidents and severe injuries.

- Never ignore the warning lamps or messages.
- Stop the vehicle at the next opportunity and in a safe place.

CAUTION

Failure to heed the control lamps and corresponding text messages when they light up may result in damage to the vehicle.

Technical requirements

Vehicles that are **factory**-equipped with a towing bracket fulfil all the technical and legal requirements for driving with a trailer.

If the **vehicle is retrofitted** with a towing bracket, only a bracket that is authorised for the maximum authorised load of the trailer that is to be towed may be fitted. The towing bracket must be suitable for the vehicle and the trailer and must be properly secured to the vehicle's chassis. Only use a towing bracket that has been authorised by SEAT for this vehicle. Always check and take into account the towing bracket manufacturer's instructions. Never fit a towing bracket “with weight distribution” or “load compensation”.

Towing bracket fitted on the bumper

Never fit a towing bracket to the bumper or to the area where the bumper is mounted. The towing bracket should not impair the bumper's function. Do not make modifications or repairs to the exhaust system or the brake system. Make regular checks to ensure that the towing bracket is secure.

Engine cooling system

Driving with a trailer increases the load on the engine and cooling system. The cooling system should have sufficient coolant and be prepared for the additional effort involved in driving with a trailer.

Trailer brakes

If the trailer has its own brake system, please take the relevant legal requirements into account. Never connect the trailer's brake system to the vehicle's brake system.

Tow rope

Always use a cable between the vehicle and the trailer » page 259.

Trailer rear lights

The trailer's rear lights should comply with the statutory safety regulations » page 259.

Never connect the trailer's rear lights directly to the vehicle's electric system. If you are not sure that the trailer's electrical connection is correct, have it checked by a specialised workshop. SEAT recommends visiting a SEAT dealership for this.

Exterior mirrors

If you cannot see the area behind the trailer with the exterior mirrors of the towing vehicle, additional mirrors will have to be installed in accordance with the regulations of the country in question. The exterior mirrors should be adjusted before you start driving and must provide a sufficient field of vision at the rear.

Trailer maximum electricity consumption

Consumers	Europe, Asia, Africa, South America and Central America	Australia
Brake lights (total)	84 Watts	108 Watts
Turn signal (on each side)	42 Watts	54 Watts
Side lights (on each side)	50 Watts	100 Watts
Reverse lights (on each side)	42 Watts	54 Watts
Rear fog light	42 Watts	54 Watts
Never exceed the values indicated!		

⚠ WARNING

If the towing bracket is wrongly fitted or is not the right one, the trailer could become detached from the vehicle and cause serious injury.

ⓘ CAUTION

- If the rear lights of the trailer are not correctly connected, the vehicle's electronic system may be damaged.
- If the trailer absorbs excessive electric current, the vehicle's electronic system may be damaged.

- Never connect the trailer's electric system directly to the electrical connections of the tail lights or any other power sources. Only use the connections intended for providing electric current to the trailer.

Electrical unlocking tow hitch

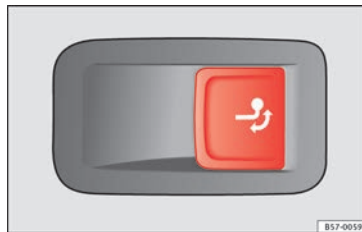


Fig. 217 On the right side of the luggage compartment: button for unlocking the tow hitch.

» table on page 2

The tow hitch is located in the bumper. The electrical unlocking tow hitch cannot be disassembled.

There should be no person, animal or object in the path of the tow hitch » ⚠.


Unlock the tow hitch and remove it

- Stop the vehicle and connect the electronic parking brake » page 170.
- Switch off the engine.
- Open the rear lid.
- Pull the » Fig. 217 button briefly. The tow hitch unlocks electrically and automatically turns outwards. The control lamp in the button will flash » Fig. 217.
- Remove the tow hitch with your hand until you feel and see that it has engaged and the control lamp on the button stays on.
- Close the tailgate.

Cover the tow hitch

- Stop the vehicle and apply the electronic parking brake.
- Switch off the engine.
- Unhook the trailer and interrupt the electrical connection between it and the vehicle. If you are using an adapter, remove it from the trailer's power socket.
- Open the rear lid.
- Pull the » Fig. 217 button briefly. The tow hitch unlocks electrically.
- Turn the tow hitch under the bumper with your hand until you feel and see that it engages and the control lamp on the » Fig. 217 button stays on.
- Close the tailgate.

Meaning of control lamp

- If the warning light of the button » Fig. 217 is *flashing*, this means that the tow hitch has not been attached properly or is damaged » .
- If the warning lamp *stays on* with the rear lid open, the tow hitch is correctly in place both when engaged and when covered.
- The control lamp of the button will go off approx. 1 minute after closing the rear lid.

WARNING

Undue use of the towing bracket may cause injury and accidents.

- Only use the tow hitch if it is properly engaged.
- Always ensure that no person, animal or object is to be found in the path of the tow hitch.
- Never use a tool or instrument while the tow hitch is moving.
- Never press the » Fig. 217 button when there is a trailer hooked to the vehicle or when a carrier system or other accessories are mounted on the tow hitch.
- If the tow hitch is not attached properly, do not use it. Instead, go to a specialised workshop and have the towing bracket checked.
- If you detect any fault in the electrical system or in the towing bracket, contact a specialised workshop and ask them to check it.

- If the ball has a diameter of less than 49 mm at any one point, do not use the towing bracket under any circumstances.

CAUTION

If you clean the vehicle with high-pressure or steam devices, do not point the jet directly towards the retractable tow hitch or the trailer power socket, as this may damage the joints or remove the grease necessary for lubrication.

Note

At extremely low temperatures, the tow hitch may be impossible to use. In this case, place the vehicle in a warmer location (for example, a garage).

Fitting a bicycle carrier on the retractable tow hitch

The maximum allowed weight of the carrier system, including the load, is **75 kg**. The carrier system should not protrude more than 700 mm backwards from the spherical head. Only carrier systems on which up to 3 bikes can be mounted are allowed. Heavier bicycles must be mounted as close to the vehicle as possible (tow hitch).

⚠ WARNING

The incorrect use of the tow hitch with a bicycle rack mounted on the tow hitch can cause accidents and injury.

- Never exceed the maximum weight or the limits indicated above.
- The bicycle rack may not be mounted to the neck of the hitch below the ball because, due to the shape of the neck and depending on the rack model, the rack could be incorrectly mounted on the vehicle.
- Always read and take the manufacturer assembly instructions into account.

⚠ CAUTION

If the maximum weight and limits indicated above are exceeded, the vehicle may suffer considerable damage.

- Never exceed the values indicated!

i Note

SEAT recommends removing, as far as possible, all removable parts of the bicycles before setting off. These parts include, for example, baskets and saddlebags, child seats or batteries. This improves aerodynamics and the centre of gravity of the rack system.

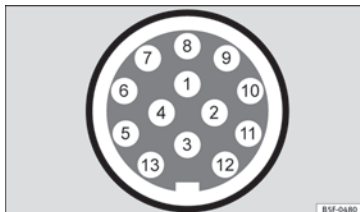
Hooking up and connecting a trailer

Fig. 218 Schematic diagram: assignment of the pins of the trailer's power socket.

Key to the Fig. 218:

Pin	Meaning
1	Left turn signal
2	Rear fog light
3	Table of pins 1, 2, 4, 5, 6, 7 and 8
4	Right turn signal
5	Rear light, right
6	Brake lights
7	Rear light, left
8	Reverse lights
9	Permanent live
10	Live charge cable
11	Table for pin 10

Key to the Fig. 218:

Pin	Meaning
12	Unassigned
13	Table for pin 9

Trailer power socket

The vehicle is fitted with a 13-pole power socket for the electrical connection between the trailer and the vehicle. With the engine running, electrical devices on the trailer receive power from the electrical connection (pin 9 and pin 10 of the trailer power socket).

If the system detects that a trailer has been connected electrically, the electrical equipment on the trailer will receive voltage through this connection (pins 9 and 10). Pin 9 has a permanent live. This powers, for example, the trailer's interior lighting. Electrical devices such as a fridge in a caravan **only** receive electrical power if the engine is running (through pin 10).

To avoid overloading the electrical system, you cannot connect the ground wires of pin 3, pin 11 or pin 13.

If the trailer has a **7-contact connector**, you will need to use an adapter cable. In this case the function corresponding to pin 10 will not be available. »

Tow rope

The tow rope must always be securely fixed to the towing vehicle and loose enough so that the vehicle can handle turns smoothly. However, make sure that the cable does not rub on the ground while driving.

Trailer rear lights

Always check the trailer's rear lights to ensure they are working correctly and that they comply with the relevant safety regulations. Make sure that the maximum permissible power that can be absorbed by the trailer is not exceeded » page 257.

Connection to the anti-theft system

The trailer is included in the anti-theft system if the following conditions are met:

- If the vehicle is factory-equipped with an anti-theft alarm and towing bracket.
- If the trailer is electrically connected to the towing vehicle through the trailer power socket.
- If the electrical systems of the vehicle and trailer are in perfect condition and have no faults or damage.
- If the vehicle is locked with the key and the anti-theft alarm is activated.

When the vehicle is locked, the alarm is triggered if the electrical connection with the trailer is cut off.

Before hitching or unhitching a trailer, always turn off the anti-theft alarm. Otherwise, the tilt sensor could cause the alarm to go off.

Trailers with LED rear lights

For technical reasons, trailers fitted with LED rear lights cannot be connected to the anti-theft alarm system.

When the vehicle is locked, the alarm does not go off when the electrical connection with the trailer is cut if it has rear lights with light-emitting diodes.

If the **Eco** driving profile was selected when hitching the trailer, this will automatically switch to the **Normal** profile. If the system cannot detect the attached trailer or if the towing bracket has been retrofitted by an auto repair shop other than SEAT, you must manually select the **Normal** profile before you start driving with a trailer attached. To reconnect the **Eco** profile once the trailer has been unhitched, switch the ignition off and back on once.

WARNING

If the cables are improperly or incorrectly connected, it may lead to an excessive amount of current supplied to the trailer, which can cause abnormalities in the entire vehicle electronic system, as well as accidents and serious injuries.

- Ensure that any repairs that need to be carried out on the electrical system are carried out by a specialised workshop.
- Never connect the trailer's electric system directly to the electrical connections of the tail lights or any other power sources.

WARNING

Contact between the pins of the trailer power socket can cause short circuits, overloading of the electrical system or failure of the lighting system, and consequently can cause accidents and serious injuries.

- Never connect the pins of the trailer power socket to each other.
- Make sure any work on bent pins is carried out by a specialised workshop.

CAUTION

Do not leave the trailer connected to the vehicle when parked; place it on its support wheel or its supports. If the vehicle rises or falls due, for example, to a variation of the load or a burst tyre, increased pressure will be placed on the towing bracket and the trailer, and both the vehicle and the trailer can be damaged.

Note

- In case of malfunctioning of the electrical systems of the vehicle or trailer, as well as of


the anti-theft system, have these checked out by a specialised workshop.

- If the trailer accessories consume energy through the power socket to the trailer and the engine is turned off, the battery will discharge.

- If the vehicle battery is running low, the electrical connection with the trailer will be automatically cut.

Loading a trailer

Technically permissible maximum trailer weight and vertical load on the coupling device

The technically permissible maximum trailer weight is the weight that the vehicle can tow » . The vertical load on the coupling load is exerted vertically from above on the tow hitch of the towing bracket » page 303.

The information on the maximum trailer weight and vertical load on the coupling device contained in the type plate of the towing bracket are experimental values only. The correct figures for your specific model, which may be lower than these figures, are given in the vehicle documentation. The information in the vehicle documentation takes precedence at all times.

To promote safety while driving, SEAT recommends making the most of the maximum ver-

tical load technically permissible on the coupling device » page 255. An insufficient vertical load has a negative influence on the behaviour of both the vehicle and trailer.

The vertical load increases the weight on the rear axle, reducing the vehicle's carrying capacity.

Gross combination weight of the towing vehicle and trailer

The gross combination weight is the actual weight of the loaded vehicle plus the actual weight of the loaded trailer.

In some countries trailers are classified into distinct categories. SEAT recommends obtaining information from a specialised workshop regarding which type of trailer is most suitable for your vehicle.

Trailer loading

The weight of the towing vehicle and trailer must be balanced. In order to do this, the load must be as close as possible to the maximum vertical load technically permissible on the coupling point, and it must be evenly distributed between the back and front of the trailer:

- Distribute loads in the trailer so that heavy objects are as near to the axle as possible or above it.
- Secure the trailer load properly.

Tyre pressure

Set the tyre pressure of the trailer tyres in accordance with the trailer manufacturer's recommendations.

When towing a trailer, inflate the tyres of the towing vehicle with the maximum allowable pressure » page 292.

WARNING

If the maximum permissible axle weight, the maximum load technically permissible on the coupling point, the maximum authorised vehicle weight or the gross combination weight of the towing vehicle and trailer are exceeded, accidents and serious injuries may occur.

- Never exceed the values indicated!
- The actual weight on the front and rear axles must never exceed the maximum permissible axle weight. The weight on the front and rear axles must never exceed the maximum permissible weight.

WARNING

A shift in weight could jeopardize the stability and security of the towing vehicle and trailer, which could lead to accidents and serious injuries.

- Always load the trailer correctly.
- Always secure the load properly using belts or straps that are suitable and in good condition.

Driving with a trailer

Adjusting the headlights

When towing a trailer, the front part of the vehicle could lift up, and if the dipped beams are on, this could dazzle other drivers. Use the headlight range control to lower the cone of light. If you do not have headlight range control, have the headlights adjusted by a specialised workshop.

Special characteristics of driving with a trailer




- If your trailer has an **overrun brake**, brake *gently at first* and then rapidly. This will prevent the jerking that can be caused by the locking of trailer wheels.
- Due to the gross combination weight of the towing vehicle and trailer, the braking distance increases.
- When going down a slope, go into lower gear (if using a manual gearbox or the Tiptronic automatic gearbox) to take advantage of the braking power provided by the engine. Otherwise, the braking system could overheat and even fail.
- The trailer weight, as well as the gross combination weight of the towing vehicle and trailer, change the centre of gravity and the properties of the vehicle.
- If the towing vehicle is empty and the trailer is loaded, then the load distribution is in-

correct. Under these conditions, drive slowly and with extra caution.

Hill starts with a trailer

Depending on the slope of the hill and the combination weight of the towing vehicle and trailer, the vehicle might start rolling backwards slightly when you first start up.

For hill-starting with a trailer, do the following:

- Press and hold the brake pedal.
- Press the  button to disconnect the electronic parking brake **» page 170**.
- If the vehicle is equipped with a manual gearbox, push the clutch pedal all the way down.
- Put the vehicle into first gear or turn the selector lever to position **D/S** **» page 176**.
- Pull out the  button and hold it in that position to stop the towing vehicle and trailer with the electronic parking brake.
- Release the brake pedal.
- Start driving slowly. To do this, in the case of a manual gearbox, slowly release the clutch pedal.
- Do not release the  button until the engine has sufficient force to start driving.

WARNING

If a trailer is pulled incorrectly, this may lead to loss of control of the vehicle and serious injury.



- **Driving with a trailer and transporting heavy or large objects will change the vehicle handling and braking distances.**
- **Always drive cautiously and carefully. Brake earlier than usual.**
- **Adapt your speed and driving style at all times to suit visibility, weather, road and traffic conditions. Slow down, especially when driving down hills or slopes.**
- **Accelerate with particular care and caution. Avoid sudden braking and manoeuvres.**
- **Take great care when overtaking. Reduce speed immediately if you notice that the trailer is swaying, however slightly.**
- **Never attempt to “straighten” the towing vehicle and trailer while accelerating.**
- **Take into account the speed limit for vehicles with a trailer, as it could be lower than for vehicles without a trailer.**

Stabilisation of the towing vehicle and trailer

The stabilisation of the towing vehicle and trailer together is an additional function of the electronic stability control (ESC).

If the system detects that the trailer is swaying, it intervenes automatically with the driver steering recommendation to reduce the swaying of the trailer.

Requirements for the stabilisation of the towing vehicle and trailer

- The vehicle is factory-equipped with a towing bracket or has been retro-fitted with a compatible towing bracket.
- The ESC and ASR are active. The control lamp  or  is not lit up on the instrument panel.
- The trailer is electrically connected to the towing vehicle through the trailer power socket.
- The vehicle is travelling at over 60 km/h (approx. 37 mph).
- The maximum vertical load technically permissible is being utilised on the coupling device.
- The trailer has a rigid draw bar.
- If the trailer has brakes, it must be equipped with a mechanical overrun brake.

WARNING

The enhanced security provided by the electric stability control of the towing vehicle and trailer should not lead you to take any risks that could compromise your safety.

- Adapt your speed and driving style at all times to suit visibility, weather, road and traffic conditions.
- Accelerate with caution when the road is slippery.
- When adjusting any settings, stop accelerating.

WARNING

The electric stability control for the towing vehicle and trailer may not correctly detect all driving conditions.

- When the ESC is switched off, the stabilisation of the towing vehicle and trailer is also switched off.
- The stability system does not always detect light and unstable trailers, so it may not stabilise these correctly.
- When driving on slippery surfaces with poor grip, the trailer can even *interfere* with the stability system.
- Trailers with a high centre of gravity can tip even without having previously swayed.
- If a trailer is not attached, but the trailer power socket is connected (e.g. installation of a bicycle rack with lights), repeated automatic braking may occur in extreme driving conditions.

Retrofitting a towing bracket

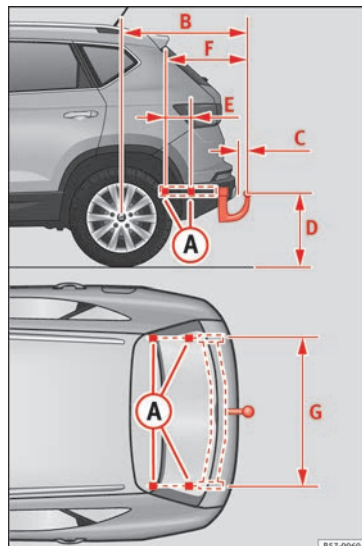


Fig. 219 Limits and attachment points for retrofitting a towing bracket.

SEAT recommends that towing brackets be retrofitted at a specialised workshop. For example, it may very well be necessary to adjust the cooling system or mount thermal protection plates. SEAT recommends visiting a SEAT dealership for this.

If a towing bracket is retrofitted, the distance specifications should always be kept in mind. The distance between the centre of the spherical head and the road »» Fig. 219 **D** must never be less than that indicated. This also applies when the vehicle is fully loaded, including the technically permissible maximum vertical load on the coupling device.

Distance specifications »» Fig. 219:

- A** Attachment points
- B** 932.5 mm
- C** 65 mm min.
- D** 350-420 mm
- E** 220 mm
- F** 615.5 mm
- G** 1,043 mm

⚠ WARNING

If the cables are improperly or incorrectly connected, this may lead to malfunctions in the entire vehicle electronic system, as well as to accidents and serious injuries.

- Never connect the trailer's electric system to the electrical connections of the tail lights

or any other unsuitable power sources. Only use suitable connectors to connect the trailer.

- The towing bracket should be retrofitted only at a specialised workshop.

⚠ WARNING

If the towing bracket is badly fitted or unsuitable, the trailer may separate from the vehicle while driving. This could cause serious accidents and fatal injuries.

i Note

Only use towing brackets that have been approved by SEAT for the model in question.

Advice

Care and maintenance

Accessories and modifications to the vehicle

Accessories, replacement parts and repair work

Always ask your dealer or specialist retailer for advice before purchasing accessories and replacement parts.

Your vehicle is designed to offer a high standard of active and passive safety. For this reason, we recommend that you ask a SEAT Official Service for advice before fitting accessories or replacement parts. Your SEAT Official Service has the latest information from the manufacturer and can recommend accessories and replacement parts which are suitable for your requirements. They can also answer any questions you might have regarding official regulations.

We recommend you to use only **SEAT accessories** and **Genuine SEAT parts**[®]. SEAT has tested these parts and accessories for suitability, reliability and safety. SEAT Official Services have the necessary experience and facilities to ensure that the parts are installed correctly and professionally.

Any **retro-fitted equipment** which has a direct effect on the vehicle and/or the way it is driven, such as a cruise control system or **electronically-controlled suspension**, must be approved for use in your vehicle and bear the **e** mark (the European Union's authorisation symbol).

If **any additional electrical devices** are fitted which do not serve to control the vehicle itself (for instance a refrigerator box, laptop or ventilator fan, etc.), they must bear the **CE** sign (manufacturer conformity declaration in the European Union).

WARNING

Accessories, for example telephone holders or cup holders, should never be fitted on the covers, or within the working range of the airbags. Otherwise, there is a danger of injury if the airbag is triggered in an accident.

Modifications

Modifications must always be carried out according to our specifications.

Unauthorised modifications to the electronic components, software, wiring or data transfer in the vehicle may cause malfunctioning. Due to the way the electronic components are linked together in networks, other indirect systems may be affected by the faults. This can seriously impair safety, lead to excessive

wear of components, and also invalidate your vehicle registration documents.

You will appreciate that your SEAT dealership cannot be held liable for any damage caused by modifications and/or work performed incorrectly.

We therefore recommend that all work should be performed by a SEAT Official Service using **genuine SEAT parts**[®].

WARNING

Incorrectly performed modifications or other work on your vehicle can lead to malfunctions and cause accidents.

Radio transmitters and office equipment

Radio transmitters (fixed installation)

Any retrofit installations of radio transmitters in the vehicle require prior approval. SEAT generally authorises in-vehicle installations of approved types of radio transmitters provided that:

- The aerial is installed correctly.
- The aerial is installed on the exterior of the vehicle (and shielded cables are used together with non-reflective aerial trimming).
- The effective transmitting power does not exceed 10 Watts at the aerial base.




A SEAT Official Service and specialised workshop will be able to inform you about options for installing and operating radio transmitters with a *higher* transmitting power.

Mobile radio transmitters

Commercial mobile telephones or radio equipment might interfere with the electronics of your vehicle and cause malfunctions. This may be due to:

- No external aerial.
- External aerial incorrectly installed.
- Transmitting power more than 10 W.

You must, therefore, do not operate portable mobile telephones or radio equipment *inside the vehicle* without a properly installed external aerial »» .

Please note also that the maximum range of the equipment can only be achieved with an *external* aerial.

Business equipment

Retrofit installation of business or private equipment in the vehicle is permitted, provided the equipment cannot interfere with the driver's immediate control of the vehicle and that any such equipment carries the **CE** mark. Any retrofit equipment that could influence the driver's control of the vehicle must have a type approval for your vehicle and must carry the **e** mark.

WARNING

Mobile telephones or radio equipment which is operated inside the vehicle without a properly installed external aerial can create excessive magnetic fields that could cause a health hazard.

Note

- The posterior fitting of electric and electronic equipment in this vehicle affects its licence and could lead to the withdrawal of the vehicle registration document under certain circumstances.
- Please use the mobile telephone/radio operating instructions.

WARNING

- Cleaning products and other materials used for car care can be damaging to your health if misused.
- Always keep care products in a safe place, out of the reach of children. Failure to comply could result in poisoning.

For the sake of the environment

- If possible, use environmentally friendly products.
- The remains of car care products should not be disposed of with ordinary household waste.

Care and cleaning

General information

Regular and careful care helps to **maintain the value** of the vehicle. This may also be one of the requirements for upholding any warranty claims in the event of corrosion or paint defects.

SEAT Official Services and specialist retailers carry stocks of suitable **car care materials**. Please follow the instructions for use on the packaging.

Vehicle exterior care

Washing the vehicle

The longer substances such as insects, bird droppings, resinous tree sap, road dirt, industrial deposits, tar, soot or road salt and other aggressive materials remain on the vehicle, the more damage they do to the paintwork. High temperatures (for instance due to strong sunlight) further intensify the corrosive effect.

After the period when salt is put on the roads it is important to have the underside of the vehicle washed thoroughly.

Automatic car washes

Before going through a car wash, be sure to take the usual precautions such as closing the windows and roof. If the vehicle has special accessories such as spoilers or a roof rack or two-way radio aerial, etc., it is advisable to consult the car wash tunnel operator.

It is best to use a car wash without revolving bristles if possible.

Washing the vehicle with a high pressure cleaner

When washing the vehicle with a high-pressure cleaner, always follow the operating instructions for the equipment. This applies particularly to the **operating pressure** and the **spraying distance**. Do not hold the nozzle too close to soft materials such as rubber hoses or seals. The same applies to the parking aid sensors*, which are located in the rear bumper.

Do not use a nozzle that sprays the water out in a **direct stream** or one that has a **rotating jet** for forcing off dirt.

Washing the car by hand

When washing the car by hand, use plenty of water to soften the dirt first, and rinse off as well as possible.

Then clean the vehicle with a soft **sponge, glove** or **brush** using only slight pressure. You should start on the roof and work down.

Special car **soap** should only be used for very persistent dirt.

Rinse the sponge or glove thoroughly and often.

Wheels, sills and similar should be cleaned last. Use a second sponge for this.

WARNING

- The vehicle should only be washed with the ignition switched off. Failure to follow this instruction could result in an accident.
- Do not clean the underside of chassis, the inside of wheel arches or wheel trims without protecting your hands and arms. You may cut yourself on sharp-edged metal parts. Otherwise, there is a risk of sustaining cuts.
- When washing the car during the winter season: water and ice in the brake system can reduce braking effectiveness: risk of accident!

CAUTION

- Do not wash the vehicle in direct sunlight – otherwise the paint can be damaged.
- Do not use sponges, abrasive household sponges or similar to clean insect remains. This could damage the surface.
- Clean off stubborn dirt (insects, etc.) from the headlights at regular intervals, for instance when filling the fuel tank. The headlights should only be washed with water, do

not wipe them with a dry cloth or sponge. It is best to use soapy water.

• Never wash tyres with a jet that sprays the water out in a direct stream. This could damage the tyres even if the spray is kept at a distance and only used for a very short time.

• Before washing the vehicle in an automatic car wash, please make sure to retract the exterior mirrors to prevent them from being damaged. Electrically retractable exterior mirrors must not be folded in or out by hand, always use the electrical power control.

CAUTION

- Before washing the vehicle in an automatic car wash, please proceed as follows to lock the wiper arms so that they are not moved towards the top of the windscreen:
 - the bonnet must be closed.
 - switch the ignition on and off.
 - press the windscreen wiper lever forward briefly (windscreen washer function). This will lock the wiper arms.

For the sake of the environment

The car should only be washed in special wash bays. These areas are prepared to prevent oily water from getting into the public drains. In some places, washing vehicles outside the areas intended for this purpose is prohibited.

Camera sensors and lenses

- Use a small brush to remove snow and a de-icer spray to remove ice.
- Clean the sensors with a solvent-free product and a soft, dry cloth.
- Moisten the camera lens using a standard alcohol-based glass cleaning agent and clean the lens with a dry cloth. In the *active lane assist**, the area in front of the lens is normally cleaned with the windscreen washer.

ⓘ CAUTION

- **When you clean the vehicle with a pressure washer:**
 - Stay a suitable distance from the sensors on the front and rear bumpers.
 - Do not clean the camera lenses or surrounding area with the pressure washer.
- Never use warm or hot water to remove snow and ice from the reverse camera lens, as it could crack the lens.
- Never use abrasive cleaning agents on the lens.

Waxing and polishing

Care

Waxing protects the paintwork. It is time to apply a **coat of good wax** when water no lon-

ger **forms droplets** and rolls off the clean paintwork.

Even if a **wax solution** is used regularly in the vehicle washing tunnel, it is advisable to protect the paint with a hard wax coating at least twice a year.

In the summer, you will find it is much easier to remove dead insects (which accumulate on the bumper and the front of the bonnet) if the car has been treated with care products *recently*.

Polishing

Polishing is only necessary if the paint has lost its shine, and the gloss cannot be brought back by putting on wax.

If the polish does not contain wax, a wax product should be applied after polishing.

ⓘ CAUTION

- Do not use polishes and hard wax on painted parts with a matt finish or on plastic parts.
- Do not apply paint polishes to the side trim that runs around the panoramic roof and ends on the windscreen. However, it can be treated with hard wax.

Trims

In respect for the environment, the silver-plated trims on the body are made of pure aluminium (they do not contain chrome).

Dirt or marks on the trim mouldings should be removed with a **cleaning product with a neutral PH** (do not use a chrome cleaner). Body polish is also unsuitable for use on trim mouldings. The intensive cleaning fluids often used before the car goes into a car wash may contain alkaline substances, which can cause dull or milky patches when they dry out.

SEAT Official Services carry stocks of cleaning products which have been tested for use on your vehicle and are not harmful to the environment.

Plastic parts

Plastic parts are cleaned with a power washer. If this is not sufficient, plastic parts should only be treated with a special solvent-free **plastic cleaning agent**. Do not use paintwork cleaners, polishes or wax on plastic parts.

Carbon parts

The carbon parts on your vehicle have a painted surface. They do not need any special care and are cleaned just like any other painted part » page 266.

Paint damage

Minor damage to the paint, such as scratches or stone chips, should be touched up *without delay* before the metal starts to corrode. Suitable **touch-up brushes** or **sprays** for your car can be obtained from a SEAT Official Service.

The number of the original paint finish on the vehicle is given on the data sticker » page 301.

If corrosion is already visible it must be thoroughly removed by a specialised workshop.

Windows

Clear vision is an essential safety factor.

The windscreen must not be cleaned with insect remover or wax, otherwise the windscreen wipers will not function properly (judging).

Traces of rubber, oil, grease or silicone can be removed with a **window cleaning solution** or a **silicone remover**. Wax residue can only

be removed with a special cleaner. Your SEAT Official Service will be able to provide you with more detailed information.

The windows should also be cleaned on the inside at regular intervals.

Use a separate cloth or chamois to dry the windows. Cloths used for waxing and polishing contain residues that will cause smears on the glass.

WARNING

Do not use water-repellent coatings on the windscreen. In bad visibility conditions (e.g. in the rain, dark or with a low sun), these coatings may cause dazzle: risk of accident! Such coatings can also cause the windscreen wiper blades to make noise.

CAUTION

- Remove snow and ice from windows and exterior mirrors with a plastic scraper only. To avoid scratches caused by dirt on the glass, the scraper should only be pushed in one direction and not moved to and fro.
- The heating element for the rear window is located on the inner side of the window. To avoid damaging them, do not apply stickers to these heating elements.
- Never use warm or hot water to remove snow and ice from windows and mirrors. This could cause the glass to crack!

Wheels

The wheels require regular attention to preserve their appearance. It is important to remove road salt and brake dust by washing the wheels at regular intervals, otherwise the finish will be impaired.

After washing, the wheels should only be cleaned with an "acid-free" cleaning agent for alloy wheels. This is available from SEAT Official Services and specialist retailers. Never leave the cleaning agent on the rims for any longer than specified in the instructions before rinsing it off. If the wheel cleaner fluid contains acid it can attack the surfaces of the wheel bolts.

Car polish or other abrasive agents should not be used for maintaining the rims. If the protective coating is damaged, e.g. by flying stones, the damaged area should be repaired immediately.

WARNING

Please note when cleaning the wheels that water, ice and road salt can impair the effectiveness of the brakes; this can cause an accident.

Exhaust tail pipe

It is important to remove road salt and brake dust by washing the wheels at regular »

intervals, otherwise the exhaust tail pipe material could be damaged. To remove impurities, do not use rim, paint or chrome cleaners or other abrasive products. Clean the exhaust tail pipes with cleaning products that are suitable for stainless steel.

SEAT Official Services carry stocks of cleaning products that have been tested and approved for use on your vehicle.

Caring for the vehicle interior

Radio display/Easy Connect* and control panel*

The display can be cleaned with a soft cloth and a professionally available "LCD cleaner". Moisten the cloth with a small amount of the cleaning fluid.

The Easy Connect control panel* should first be cleaned with a brush so that no dirt goes into the device or between the keys and housing. Next, we recommend cleaning the Easy Connect control panel* using a cloth dampened with water and washing-up liquid.

ⓘ CAUTION

- To avoid scratching the screen, do not wipe the display with a dry cloth.
- To avoid damage, ensure that no liquid goes into the Easy Connect control panel*.

Plastic and leatherette parts

Plastic parts and leatherette can be cleaned with a damp cloth. If this is not sufficient, plastic parts and leatherette should only be treated with a **special solvent-free plastic cleaner**.

Textile covers and trim parts

Textile covers and trim parts (e.g. seats, door trim) should be cleaned regularly with a vacuum cleaner. This will remove surface dirt which could otherwise be rubbed into the textile material during use. Do not use steam cleaners, as the steam could carry the dirt deeper into the textile material.

Normal cleaning

We recommend that you use a soft sponge or a commercially available lint-free, micro-fibre cloth for normal cleaning. Only use brushes on floor coverings and mats, as other textile surfaces could become damaged.

In the case of normal surface dirt you can use a foam cleaner. Use a sponge to spread the foam on the textile surface and to work it into the material lightly. However, make sure that the textile material does not become soaking wet. Then dab off the foam with a dry and absorbent cloth (e.g. a micro-fibre cloth) and

vacuum off any residue once the surface is completely dry.

Cleaning stains

Treat drink stains (such as coffee or fruit juice, etc.) with a cleaning solution for delicate fabrics. This solution should be applied with a sponge. If the stains are difficult to remove, a washing paste can be applied directly onto the stain and worked into the fabric. The surface will then have to be wiped with clear water to remove any residue left by the paste. To do so, use a damp cloth or sponge and then dab the stain with an absorbent cloth.

Remove chocolate or make-up stains with a cleaning paste (for e.g., soft soap). Then remove the soap with water (wet sponge).

A spirit-based cleaner can be used to remove grease, oil, lipstick or ball point pen. Then dab the dissolved grease or colour particles off with an absorbent cloth or similar. You may also have to treat the stain once more using washing paste and water.

If the covers or textile trim panels are badly soiled we recommend that you have them cleaned by a professional cleaning company with a shampoo and spray.

Note

Open Velcro fasteners on clothes can damage the seat upholstery. Make sure they are closed.

Natural leather

General information

Our range of leathers is large. The main type used is particularly nappa in various forms, that is, leather with a smooth surface in different colours.

The amount of dye used determines the appearance and properties of leather. If the leather is left in a more natural state, it retains its typical natural napped appearance and confers excellent all-weather properties to the seats. Fine veins, healed scars, insect bites, wrinkles and a subtle variation in shading remain visible; these are the characteristic features of genuine natural leather.

Natural napped leather does not have a protective surface coating of dye. It is therefore somewhat more prone to damage. This should be borne in mind if children or pets often travel in the car, or if there are other factors that could lead to damage.

Types of leather with a coloured surface coating are likely to be more resistant to damage. This has a great advantage for day-to-day use. However, this means that the typical

natural characteristics of the surface are less apparent, though this does not affect quality.

Cleaning and care

Due to the natural properties of the specially selected hides employed, the finished leather has a certain sensitivity to grease and dirt, etc. so a degree of care is required in everyday use and when looking after the leather. Dark clothing (especially if damp or incorrectly dyed) may stain leather upholstery on the seats. Dust and grit in the pores and seams can scratch and damage the surface. Therefore leather should be cleaned at regular intervals, depending on the actual amount of use. When they have been in use for a certain time, your car seats will acquire a typical and unmistakable patina. This is characteristic for leather as a natural product and is a sign of genuine quality.

To maintain the value of natural leather you should note the following points:

ⓘ CAUTION

- **Avoid exposing leather to direct sunlight for long periods, otherwise it may tend to lose some of its colour. If the car is left for a prolonged period in the bright sun, it is best to cover the leather.**
- **Sharp-edged objects on clothing, such as belts, zip fasteners, rivets or similar, can also leave permanent scratches and rough marks on the surface of the leather.**

Note

- **Use a suitable impregnating cream with ultra-violet protection at regular intervals and after cleaning. The cream nourishes and moisturises the leather, keeps it supple and able to breathe. A protective film will also form.**
- **Clean the leather every 2 to 3 months and remove fresh dirt as soon as possible.**
- **Remove stains from fresh ball-pen and other inks, lipstick, shoe cream and similar stains as soon as possible.**
- **Preserve the colour of the leather. A special coloured cream will renew the colour of the leather when required and will eliminate differences in colour.**

Cleaning and care of leather upholstery

Natural leather requires an extra degree of attention and care.

Normal cleaning

– Moisten a cotton or woollen cloth with water and wipe over the leather surfaces.

More stubborn dirt

– More stubborn dirt can be removed using a mild soap solution (pure liquid soap: two »

tablespoons dissolved in one litre of water).

- Do not let the water soak through the leather or penetrate into the seams.
- Then wipe off with a soft, dry cloth.

Removal of stains

- Remove fresh **water-based** stains such as coffee, tea, juices, blood etc. with an absorbent cloth or kitchen roll, or use the cleaning agent from the care set for dried-on stains.
- Remove fresh **grease-based** stains that have not penetrated the surface such as butter, mayonnaise, chocolate, etc. with an absorbent cloth or kitchen roll or with the cleaning agent from the care set.
- Treat **fat-based, dried-in** stains with grease-dissolving spray.
- Treat **less common stains** on leather, such as ball-pen and other inks, felt-tip pens, nail polish, dispersion paint, shoe cream etc. with a special leather stain remover.

Leather maintenance

- The leather should be treated regularly (about twice a year) with a special leather-care product.
- Apply these products very sparingly.
- Then wipe off with a soft cloth.

Should you have questions regarding the care and cleaning of the leather upholstery in your vehicle, we recommend that you contact your SEAT Official Service. Our representatives will be happy to advise you and tell you about the product range for leather conservation, for example:

- Cleaning and care set.
- Coloured leather-care cream.
- Stain remover for ball-pen inks, shoe cream etc.
- Grease dissolving spray.
- New products and further developments

ⓘ CAUTION

On no account use solvents (such as petrol, turpentine), wax polish, shoe cream or similar materials.

Cleaning Alcantara upholstery

Removing dust and dirt

- Moisten a cloth *just a little* and wipe down the seat covers.

Removing stains

- Moisten a cloth with lukewarm water or diluted **white spirits**.
- Dab at the stain. Start at the outside and work inwards.

- Dry the clean area with a soft cloth.

Do not use leather cleaning products on Alcantara seat covers.

You may use a suitable soap on dust and dirt.

Dust and grit in the pores and seams can scratch and damage the surface. If the car is left standing in the sun for long periods, Alcantara leather should be protected against direct sunlight to prevent it from fading. However, slight colour variations will arise in normal use.

ⓘ CAUTION

- **Do not use solvents, wax polish, shoe cream, stain removers, leather cleaning products or any similar products on Alcantara.**
- **To avoid damage, stubborn stains should be removed by a specialised workshop.**
- **On no account use brushes, hard sponges or similar utensils.**

Seat belts

- Keep the seat belts clean.
- For cleaning, use a mild solution of soap and water.
- Check the condition of the seat belts at regular intervals.

The retract function may not operate properly in very dirty belts. Make sure that the inertia reel seat belts are completely dry before allowing them to retract.

ⓘ CAUTION

- Do not remove the seat belts from the vehicle to clean them.
- Do not use chemical cleaning agents on the seat belts, as this can damage the webbing. Ensure that the seat belts do not come into contact with corrosive fluids.
- If you find any damage to the belt webbing, belt fittings, the belt retractor or the buckle, the belt in question must be replaced by a specialised workshop.

Intelligent technology


Electromechanical steering

Electro-mechanical power steering assists the driver when steering.

Electro-mechanical power steering adapts *electronically* to the speed of the car, torque and turning angle.


If the power steering should fail at any time or the engine is switched off (for instance when being towed), the car can still be steered. However, more effort than normal will be required to turn the steering wheel.

Driver warning lamps and messages

 (in red) **Faulty steering! To park the vehicle**

If the warning lamp remains on and the driver indication appears, the power steering could be faulty.

Do **not** continue driving. Seek specialist assistance.

 (in yellow) **Steering: System fault! You may continue driving.**

If the warning lamp comes on, the steering could react with more difficulty or more sensitivity than normal. In addition, when driving in a straight line the steering wheel may be off-centre.

Drive slowly to a specialised workshop and have the fault repaired.

 (in yellow) **Steering lock: fault! Go to an Official Service**



The electronic steering lock is malfunctioning.

Go to a specialised workshop as soon as possible and have the fault repaired.

WARNING

Take it immediately to a specialised workshop and have the fault repaired: risk of accident!

Note

If the lamp  (in red) or else  (in yellow) lights up briefly, you may continue driving.


Four-wheel drive

✓ Valid for vehicles: with four-wheel drive

On four-wheel drive models, the engine power is distributed to all four wheels

General notes


On four-wheel drive vehicles, the engine power is distributed to all four wheels. The distribution of power is controlled automatically according to your driving style and the road conditions. Also see » page 173. »

The four-wheel drive is specially designed to complement the superior engine power. This combination gives the vehicle exceptional handling and performance capabilities, both on normal roads and in more difficult conditions, such as snow and ice. Even so (or perhaps especially for this reason), it is important to observe certain safety points »» » .

Winter tyres

Thanks to four-wheel drive, your vehicle will have plenty of traction in winter conditions, even with the standard tyres. Nevertheless, we still recommend that winter tyres or all-season tyres be fitted on all *four* wheels to give even better *braking response*.

Snow chains

On roads where snow chains are mandatory, this also applies to cars with four-wheel drive »»  page 56.

Changing tyres

On vehicles with four-wheel drive, all four tyres must have the same rolling circumference. Also avoid using tyres with varying tread depths »» page 293.

Off-roader?

Your SEAT is not an off-road vehicle: it does not have enough ground clearance to be used as such. It is therefore best to avoid

rough tracks and uneven terrain as much as possible.

WARNING

- **Even with four-wheel drive, you should always adjust your speed to suit the conditions. Do not let the extra safety features tempt you into taking any risks when driving. Risk of accident!**
- **The braking capability of your vehicle is limited by the tyres' grip. It is therefore no different from a car without four-wheel drive. So do not be tempted to drive too fast on firm or slippery roads just because the vehicle still has good acceleration in these conditions. Risk of accident!**
- **On wet roads bear in mind that the front wheels may start to "aquaplane" and lose contact with the road if the car is driven too fast. If this should happen, there will be no sudden increase in engine speed to warn the driver, as occurs with a front-wheel drive car. For this reason you should always choose a driving speed suitable for the road conditions. Risk of accident!**

Power Management

This system helps to ensure reliable starting

The power management controls the distribution of electrical energy and thus helps to en-

sure that there is always enough power available to start the engine.

If a vehicle with a conventional electrical system is left parked for a long time, the battery will gradually lose its charge because certain electrical devices, such as the electronic gearbox lock continues to draw current even when the ignition is off. In some cases there may not be enough power available to start the engine.

Your vehicle is equipped with an intelligent power management system to control the distribution of electrical energy. This significantly improves reliability when starting the engine, and also prolongs the useful life of the battery.

The main functions incorporated in the power management system are **battery diagnosis**, **residual current management** and **dynamic power management**.

Battery diagnosis

The battery diagnosis function constantly registers the condition of the battery. Sensors detect the battery voltage, battery current and battery temperature. This enables the system to calculate the current power level and charge condition of the battery.

Residual current management

The residual current management reduces power consumption while the vehicle is


parked. It controls the supply of power to the various electrical devices while the ignition is switched off. The system takes the battery diagnosis data into consideration.

Depending on the power level of the battery, switch off the individual electrical devices one after the other to prevent the battery from losing too much charge and to ensure that the engine can be started reliably.

Dynamic power management

While the vehicle is moving, this function distributes the available power to the various electrical devices and systems according to their requirements. The power management ensures that on-board systems do not consume more electrical power than the alternator can supply, and thus maintains the maximum possible battery power level.

Note

- **Neither is the power management system able to overcome the given physical limits. Please remember that the power and useful life of the battery are limited.**
- **When there is a risk that the vehicle will not start, the alternator power failure or low battery charge level warning lamp will be shown  page 106.**

Flat battery

Starting ability has first priority.

Short trips, city traffic and low temperatures all place a heavy load on the battery. In these conditions a large amount of power is consumed, but only a small amount is supplied. The situation is also critical if electrical devices are in use when the engine is not running. In this case power is consumed when none is being generated.

In these situations you will be aware that the power management system is intervening to control the distribution of electrical power.

When the vehicle is parked for long periods

If you do not drive your vehicle for a period of several days or weeks, the power management will gradually shut off the electrical devices one by one or reduce the amount of current they are using. This limits the amount of power consumed and helps to ensure reliable starting even after a long period. Some convenience functions, such as remote vehicle opening, may not be available under certain circumstances. These functions will be restored when you switch on the ignition and start the engine.

With the engine switched off

For example, if you listen to the sound system with the engine switched off the battery will run down.

If the energy consumption means there is a risk that the engine will not start, a text will appear in vehicles with a driver information system*.

This driver indicator tells you that you must start the engine so that the battery can recharge.

When the engine is running

Although the alternator generates electrical power, the battery can still become discharged while the vehicle is being driven. This can occur when a lot of power is being consumed but only a small amount supplied, especially if the battery is not fully charged initially.

To restore the necessary energy balance, the system will then temporarily shut off the electrical devices that are using a lot of power, or reduce the current they are consuming. Heating systems in particular use a large amount of electrical power. If you notice, for instance, that the seat heating* or the rear window heater is not working, they may have been temporarily switched off or regulated to a lower heat output. These systems will be available again as soon as sufficient electrical power is available.

You may also notice that the engine runs at a slightly faster idling speed when necessary. This is quite normal, and no cause for concern. The increased idling speed allows the alternator to meet the greater power requirement and charge the battery at the same time.

Checking and refilling levels

Filling the tank


Filling up

Read the additional information carefully

»  page 48

If the automatic filler nozzle is operated correctly, it will switch itself off as soon as the fuel tank is “full”. Do not try to put in more fuel after the nozzle cuts out, as this will fill the expansion chamber in the fuel tank.

The correct fuel grade for your vehicle is given on a sticker on the inside of the fuel tank flap. Further notes on fuel can be found at » page 277.

The capacity of your vehicle's fuel tank is given in »  page 48.

WARNING

Fuel is highly flammable and can cause serious burns and other injuries.

- When refuelling, turn off the engine, the auxiliary heater » page 161 and turn off the ignition for safety reasons.
- Do not smoke when filling the fuel tank or a canister. Naked flames are forbidden in the vicinity due to the risk of explosion.

- Observe legislation governing the use, storage and carrying of a spare fuel canister in the vehicle.
- For safety reasons we do not recommend carrying a spare fuel canister in the vehicle. In an accident the canister could be damaged and could leak.
- If, in exceptional circumstances, you have to carry a spare fuel canister, please observe the following points:
 - Never fill fuel into the spare fuel canister if it is inside or on top of the vehicle. An electrostatic charge could build up during filling, causing the fuel vapour to ignite. Danger of explosion. Always place the canister on the ground to fill it.
 - Insert the filling nozzle as far as possible into the spare fuel canister.
 - If the spare fuel canister is made of metal, the filling nozzle must be in contact with the canister during filling. This helps prevent an electrostatic charge building up.
 - Never spill fuel in the vehicle or in the luggage compartment. Fuel vapour is explosive. Risk of fatal accident!

CAUTION

- If any fuel is spilled onto the vehicle, it should be removed immediately. It could otherwise damage the paintwork.
- Never run the tank completely dry. An irregular fuel supply could cause misfiring. As a

result, unburnt fuel could enter the exhaust system and damage the catalytic converter.

- When filling the fuel tank after having run it completely dry on a vehicle with a diesel engine, the ignition must be switched on for at least 30 seconds before starting the engine. When you then start the engine it may take longer than normal (up to one minute) to start firing. This is because air needs to be bled from the fuel system while starting.

 For the sake of the environment

Do not overfill the fuel tank, it may cause the fuel to overflow if it becomes warm.

 Note

There is no emergency mechanism for the manual release of the fuel tank flap. If necessary, request assistance from specialised personnel.

 Note

Diesel vehicles are fitted with a protective device that prevents the insertion of the wrong fuel hose¹⁾. It is only possible to refuel with Diesel nozzles.

- If the pump nozzle is worn, damaged, or if it is very small, it is possible that it will not be able to open the protective device. Before trying to insert the pump nozzle by turning it,

try a different pump or request specialist help.

- If you fill the tank from a reserve fuel canister, the protective device will not open. One way to resolve this is to pour the fuel in very slowly.

Fuel

Types of petrol

The correct grade of petrol is listed inside the fuel tank flap.

The vehicle is equipped with a catalytic converter and must only be run on **unleaded petrol**. The petrol must comply with European Standard EN 228 or German standard DIN 51626-1 and must be **unleaded**. You can refuel with a maximum ethanol proportion of 10 % (E10). The types of petrol are differentiated by their **octane rating (RON)**.

The following titles appear on the corresponding adhesive on the fuel tank flap:

Super unleaded 95 octane or normal 91 octane unleaded petrol

We recommend you use super 95 octane petrol. If this is not available: normal 91 octane petrol, with a slight decrease in power.

Super unleaded petrol with a minimum of 95 octanes

You should use super petrol with a minimum of 95 octanes.

If super is not available, *in an emergency* you may refuel with normal 91 octane petrol. In this case only use moderate engine speeds and a light throttle. Refuel with super as soon as possible.

Super unleaded 98 octane or super 95 octane unleaded petrol

We recommend you use super plus 98 octane petrol. If this is not available: super 95 octane petrol, with a slight decrease in power.

If super is not available, *in an emergency* you may refuel with normal 91 octane petrol. In this case only use moderate engine speeds and a light throttle. Refuel with super as soon as possible. »

¹⁾ Depending on country

Petrol additives

The quality of the fuel influences the behaviour, power and service life of the engine. This is why the petrol you use should carry suitable additives already included by the petrol industry, free of metals. These additives will help to prevent corrosion, keep the fuel system clean and prevent deposits from building up in the engine.

If good-quality petrol with metal-free additives is not available or engine problems arise, the necessary additives must be added when refuelling » ①.

Not all petrol additives have been shown to be effective. The use of unsuitable petrol additives may cause significant damage to the engine and the catalytic converter. Metal additives should never be used. Metal additives may also be contained in petrol additives for improving anti-detonation ratings or octane ratings » ①.

SEAT recommends “genuine Volkswagen Group Fuel Additives for petrol engines”. These additives can be bought at SEAT dealers, where information on how to use them can also be obtained.

⚠ CAUTION

- Do not refuel if the filler indicates that the fuel contains metal. LRP (*lead replacement petrol*) fuels contain high concentrations of metal additives. Using them may damage the engine!
- Never refuel with fuels containing a large proportion of ethanol (for example, E50, E85). This could damage the fuel system.
- Just filling one full tank of leaded fuel or fuel containing other metal additives would seriously impair the efficiency of the catalytic converter.
- Only use fuel additives that have been approved by SEAT. Octane boosting or anti-knock additives may contain metal additives that could seriously damage the engine or the catalytic converter. These additives must not be used.
- High engine speed and full throttle can damage the engine when using petrol with an octane rating lower than the correct grade for the engine.

ℹ Note

- You may use petrol with a high octane number than the one recommended for your engine.
- In those countries where unleaded petrol is not available, you may refuel with a fuel with a low lead content.

Diesel fuel


Please note the information on the inside of the fuel tank flap.

We recommend the use of **diesel** fuel which complies to European standard EN 590. If diesel fuel which meets European standard EN 590 is not available, the Cetane number (CZ) must, at minimum, be 51. If the engine is equipped with a particulate filter, the sulphur content of the fuel must be below 50 parts per million.

Winter-grade diesel

Summer fuel becomes thicker in winter and it is more difficult to start the engine. For this reason, petrol stations in some countries also offer winter diesel with improved fluidity when cold (winter-grade diesel).

Water in the fuel filter¹⁾

If your vehicle has a diesel engine and is equipped with a **fuel filter with a water separator**, the instrument panel may display the following warning:  **Water in the fuel filter**. If this is the case, take the vehicle to a specialised workshop so that they can drain the fuel filter.

¹⁾ Valid for the market: Algeria.

ⓘ CAUTION

- The vehicle is not designed for the use of FAME fuel (biodiesel). The fuel system would be damaged if you used biodiesel.
- Do not mix fuel additives, the so-called “thinners”, petrol or similar additives with diesel fuel.
- If poor-quality diesel fuel is used, it may be necessary to drain the fuel filter more frequently than is specified in the Maintenance Programme. We recommend having this done by a specialised workshop. If water is allowed to collect in the filter, this can cause engine performance problems.

Exhaust purification system for vehicles with diesel engines (AdBlue®)

Introduction

To reduce emissions, SCR (Selective Catalytic Reduction) can be used in vehicles with diesel engines. Through the special urea solution AdBlue®, SCR transforms nitrogen oxides into nitrogen and water.

AdBlue® is stored in a separate tank in the vehicle »» page 280.

⚠ WARNING

If the level of AdBlue® is too low and the ignition is switched off, it will no longer be possible to re-start the engine. Not even by jump-starting the car!

- Insert enough AdBlue® when the distance to empty is approx. 1000 km, at the latest.
- Never run the AdBlue® tank completely dry.

⚠ WARNING

AdBlue® is an irritant, corrosive liquid that can cause injuries if it comes into contact with the skin, eyes or respiratory organs.



- Before opening an AdBlue® recipient, always take the manufacturer's instructions for use into account. If the instructions are followed correctly, it is not likely that the user will come into contact with AdBlue®.
- If AdBlue® comes into contact with your eyes, rinse it immediately with plenty of water for at least 15 minutes before seeking medical attention.
- If AdBlue® comes into contact with your skin, rinse with water for at least 15 minutes and, in case of skin irritation, seek medical attention immediately.
- If you accidentally swallow AdBlue®, rinse your mouth with plenty of water for at least 15 minutes. Do not induce vomiting unless advised to by a doctor. Seek immediate medical attention.


ⓘ CAUTION


AdBlue® may damage the vehicle's painted surfaces, plastic, upholstery and carpet, among other things. In case of a spill, clean it as soon as possible with a damp cloth and plenty of cold water.

- Remove the AdBlue® that has crystallised with hot water and a sponge.

Warning and control lamps


	It lights up red
Unable to start the engine! The level of AdBlue is too low.	Park the vehicle on level ground, taking the appropriate and necessary safety precautions and fill the tank with the necessary minimum amount of AdBlue® »» page 280.
	It lights up yellow
AdBlue® level is low.	Fill tank with AdBlue® before the indicated number of kilometres »» page 280. SEAT recommends contacting a specialised workshop. »»

 together with	It lights up red
Unable to start the engine! There is a fault in the AdBlue® system.	Visit a specialised workshop without switching the ignition off and on, and have the system checked.

 together with	It lights up yellow
The AdBlue® system is malfunctioning or has been filled with AdBlue® that does not meet the prescribed standard.	Immediately consult a specialised workshop and have the system checked.

Some warning and control lamps will light up briefly when the ignition is switched on to check certain functions. They will switch off after a few seconds.

WARNING

Observe the safety warnings  **in Warning and control lamps on page 107.**

Information on AdBlue®


The consumption of AdBlue® depends on your personal driving style, the temperature

of the system and on the outdoor temperature when the vehicle is used.

AdBlue® freezes at temperatures of -11°C (+13°F). The system has heating elements that guarantee its operation even at low temperatures.

The AdBlue® tank level capacity is approximately 12 litres.

The **minimum** amount to be poured in (assuming the tank is empty) is indicated on the AdBlue® sticker located on the floor of the luggage compartment.

The AdBlue® tank should never be empty. When the distance to empty drops below 2400 km, a warning to refill the AdBlue® tank will appear on the dash panel display **» page 280**. If this information is ignored, it will later no longer be possible to re-start the engine **»  in Introduction on page 279**. If this warning does not appear, it is not necessary to refill the AdBlue® tank.

AdBlue® is a registered brand of the German Association of the Automotive Industry (VDA) and is also known as AUS32 or DEF (Diesel Exhaust Fluid).

CAUTION

Filling the AdBlue® tank excessively can cause damage to the tank.

- SEAT recommends refilling the AdBlue® tank at a specialised workshop.

Refilling AdBlue®

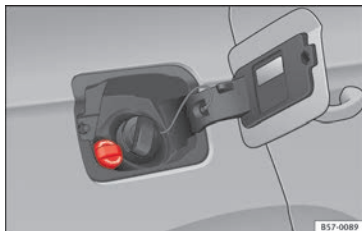


Fig. 220 AdBlue tank cap.

Operations prior to refilling

Park the vehicle on a flat surface. If the vehicle is not parked on a flat surface, but, for example, on a slope or on the side of a curb, the level indicator may not detect the load properly.

If a warning message about AdBlue® levels appears on the dash panel display, **fill at least the minimum amount required (approx. 5.7 litres)**. Only after adding this amount will the system detect that AdBlue® has been added and you will be able to start the engine again. The maximum amount that can be refilled is 12 litres.

Switch the ignition off. If the ignition is switched off during refilling, the warning to refill may continue to appear on the instrument panel display.

Opening the tank filling neck

- Open the fuel tank flap.
- Unscrew the tank cap by turning it in an anti-clockwise direction.

Fill with a refill bottle

Only use AdBlue® that complies with ISO 22241-1. Only use original containers.

- Please observe the manufacturer's instructions, indicated on the refill bottle.
- Check the expiry date.
- Remove the cap of the refill bottle.
- Insert the neck of the bottle in the tank filler neck vertically and screw the bottle on by hand, by turning it in a clockwise direction.
- Press the refill bottle in the direction of the filler neck and hold it in this position.
- Wait until the contents of the refill bottle have been poured into the AdBlue® tank. Do not compress or break the bottle!
- Turn the bottle in a counter-clockwise direction and gently pull it upwards **» 1**.
- The AdBlue® tank is full when no more liquid comes out of the bottle.

Closing the tank filling neck

- Screw on the tank cap in a clockwise direction until it is tightly closed.
- Close the fuel tank flap.

Operations before driving

- After refilling the tank, **only** switch on the ignition.
- Leave the ignition on for at least 30 seconds for the system to detect the fluid load.
- Make sure you wait for at least 30 seconds before starting the engine!

WARNING

AdBlue® should only be stored in the original container, which should be tightly closed and kept in a safe place.

- **Never keep AdBlue® in empty food containers, bottles or other similar containers. Other people may confuse it for other products.**
- **Keep AdBlue® out of the reach of children.**

CAUTION

- **Only use AdBlue® that complies with ISO 22241-1. Only use original containers.**
- **Never mix AdBlue® with water, fuel or additives. Any type of damage caused by such a mixture will not be covered by the warranty.**
- **Never pour AdBlue® into the fuel tank. This could result in engine damage.**
- **Do not carry the refill bottle inside the vehicle. If there is a leak (due to temperature changes or damage to the bottle), the AdBlue® may damage the vehicle.**

For the sake of the environment

Dispose of the refill bottle in an environment-friendly manner.

Note

You can buy refill bottles that are adequate for AdBlue® use at SEAT dealerships.

Engine compartment

Checking levels

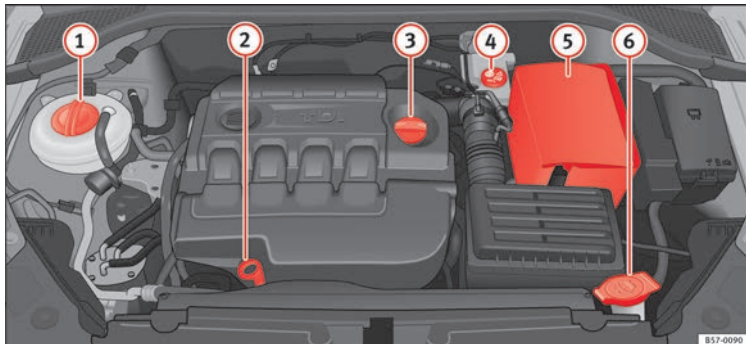


Fig. 221 Diagram for the location of the various elements.

From time to time, the levels of the different fluids in the vehicle must be checked. Never fill with incorrect fluids, otherwise serious damage to the engine may be caused.


- ① Coolant expansion tank
- ② Engine oil dipstick
- ③ Engine oil filler cap
- ④ Brake fluid reservoir
- ⑤ Vehicle battery (underneath the cover)
- ⑥ Windscreen washer reservoir


The checking and refilling of service fluids are carried out on the components mentioned above. These operations are described in »» page 282.

Overview

You will find further explanations, instructions and restrictions on the technical specifications as of »» page 301.

Work in the engine compartment

Read the additional information carefully »»  page 11

Always be aware of the danger of injury and scalding as well as the risk of accident or fire when working in the engine compartment (e.g. when checking and refilling fluids). Always observe the warnings listed below and follow all general safety precautions. The engine compartment of the vehicle is a potentially hazardous area »» .

⚠ WARNING

- Switch the engine off, remove the key from the ignition and apply the hand brake. If the vehicle has a manual gearbox, place the lever in neutral; if it has an automatic gearbox, place the selector lever in position P. Wait for the engine to cool down.
- Keep children away from the engine compartment.
- Never spill liquids used for vehicle operation on the engine compartment, as these may catch fire (e.g. the antifreeze in coolant).
- Take care not to cause short circuits in the electrical system, especially when working on the battery.
- If working inside the engine compartment, remember that, even when the ignition is switched off, the radiator fan may start up automatically, and therefore there is a risk of injury.
- Never cover the engine with additional insulating materials such as a blanket. Risk of fire!
- Do not unscrew the cap on the coolant expansion tank when the engine is hot. The cooling system is under pressure.
- Protect face, hands and arms by covering the cap with a large, thick rag to protect against escaping coolant and steam.
- If it is necessary to work in the engine compartment while the engine is running, the rotating components (for example, poly-V belt,

alternator, radiator fan) and the high voltage ignition system are an additional hazard.

- Observe the following additional warnings if work on the fuel system or the electrical system is necessary:
 - Always disconnect the battery from the on-board network.
 - Do not smoke.
 - Never work near naked flames.
 - Always keep an approved fire extinguisher immediately available.

ⓘ CAUTION

When topping up fluids make sure the correct fluid is put into the correct filler opening, otherwise this can cause serious malfunctions or engine damage.


♻ For the sake of the environment

Inspect the ground underneath your vehicle regularly so that any leaks are detected at an early stage. If you find spots of oil or other fluids in the area where it was parked, have your vehicle inspected at the workshop.

ℹ Note

In right-hand drive vehicles* some brake fluid reservoirs are on the other side of the engine compartment» **Fig. 221.**

Opening the bonnet

Read the additional information carefully »  page 11

The bonnet is released from inside the vehicle.

Check that the windscreen wiper arms are not unfolded. Otherwise the paint may be damaged.

The bonnet can only be unlocked when the driver door is open.

⚠ WARNING

Never open the bonnet if you see steam or drips of coolant being released from the engine compartment. Failure to comply could result in burns. Wait until no steam or coolant can be seen before opening the bonnet.

Closing the bonnet

- Slightly lift the bonnet.
- Release the bonnet stay before pressing it back into its support.
- Carefully close the bonnet.
- Press the bonnet down until it locks into place.
- Make sure that the bonnet catches onto its clasp. *Do not press down too hard* » **⚠** »

⚠ WARNING

- For safety reasons the bonnet must always be completely closed when the vehicle is moving. Therefore, after closing the bonnet, always check that the locking element is properly engaged. This is the case if the bonnet is flush with the adjacent body panels.
- Should you notice that the bonnet is not safely secured when the vehicle is moving, stop the vehicle immediately and close the bonnet. Failure to follow this instruction could result in an accident.

Engine oil

General notes

The engine comes with a special, multi-grade oil that can be used all year round.

Because the use of high-quality oil is essential for the correct operation of the engine and its long useful life, when topping up or changing oil, use only those oils that comply with VW standards.

The specifications (VW standards) set out in the following page should appear on the container of the service oil; when the container displays the specific standards for petrol and diesel engines together, it means that the oil can be used for both types of engines.

We recommend that the oil change indicated in the Maintenance Programme, be performed by a technical service or specialised workshop.

The correct oil specifications for your engine are listed in the »»  page 49, Oil properties.

Service intervals

Service intervals can be flexible (LongLife service) or fixed (dependent on time/distance travelled).


If the PR code that appears on the back of the Maintenance Programme booklet is PR QI6, this means that your vehicle has the LongLife service programmed. If it lists the codes QI1, QI2, QI3, QI4 or QI7, the interval service is dependent on time/distance travelled.

Flexible service intervals (LongLife service intervals*)


Special oils and processes have been developed which, depending on the characteristics and individual driving profiles, enable the extension of the oil change service (LongLife service intervals).

Because this oil is essential for extending the service intervals, it **must only** be used observing the following indications:

- Avoid mixing it with oil for fixed service intervals.

- Only in exceptional circumstances, if the engine oil level is too low »» page 285 and LongLife oil is not available, it is permitted to top up (once) with oil for **fixed service intervals** »»  page 49 (up to a maximum of 0.5 litres).

Fixed service intervals*

If your vehicle does not have the “LongLife service interval” or it has been disabled (by request), you may use oils for **fixed service intervals**, which also appear in »»  page 49, Oil properties. In this case, your vehicle must be serviced after a fixed interval of 1 year/15,000 km (10,000 miles) (whatever comes first) »» Booklet Maintenance Programme.

- In exceptional circumstances, if the engine oil level is too low »» page 285 and you cannot obtain the oil specified for your vehicle, you can add a small quantity of oil conforming to the specification ACEA A2 or ACEA A3 (petrol engines) or ACEA B3 or ACEA B4 (diesel engines) (up to 0.5 l).

Vehicles with diesel particulate filter*

The Maintenance Programme states whether your vehicle is fitted with a diesel particulate filter.

Only VW 507 00 engine oil, with reduced ash formation, may be used in diesel engines equipped with particulate filter. Using other

types of oil will cause a higher soot concentration and reduce the life of the DPF. Therefore:

- Avoid mixing this oil with other engine oils.
- Only in exceptional circumstances, if the engine oil level is too low »» page 285 and you cannot obtain the oil specified for your vehicle, you can use a small quantity of oil (once) conforming to the VW 506 00, VW 506 01, VW 505 00, VW 505 01 or ACEA B3/ACEA B4 specification. (up to 0.5 l).

Checking engine oil level

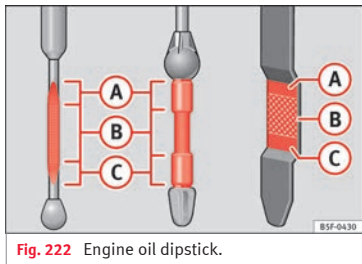


Fig. 222 Engine oil dipstick.

Read the additional information carefully
»» 📖 page 48

The engine oil dipstick indicates the level of the oil.

Checking oil level

- Park the vehicle in a horizontal position.
- Briefly run the engine at idle speed until the operating temperature is reached and then stop.
- Wait for about two minutes.
- Pull out the dipstick. Wipe the dipstick with a clean cloth and insert it again, pushing it in as far as it will go.
- Then pull it out once more and check the oil level »» Fig. 222. Top up with engine oil if necessary.

Depending on how you drive and the conditions in which the vehicle is used, oil consumption can be up to 0.5 l/1000 km. Oil consumption is likely to be higher for the first 5,000 km. For this reason the engine oil level must be checked at regular intervals, preferably when filling the tank and before a journey.

⚠ WARNING

Any work carried out in the engine compartment or on the engine must be carried out cautiously.

- When working in the engine compartment, always observe the safety warnings »» page 282.

ⓘ CAUTION

If the oil level is above the area A do not start the engine. This could result in damage to the engine and catalytic converter. Contact a Technical Service.

Topping up engine oil 🛢

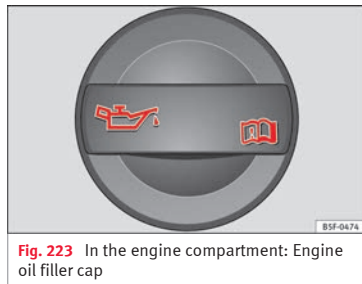


Fig. 223 In the engine compartment: Engine oil filler cap

Read the additional information carefully
»» 📖 page 48

Before opening the bonnet, read and observe the warnings »» ⚠ in Work in the engine compartment on page 283.

The position of the oil filler opening is shown in the corresponding engine compartment illustration »» page 282.

Engine oil specification »» 📖 page 49. »»

⚠ WARNING

Oil is highly inflammable! Ensure that no oil comes into contact with hot engine components when topping up.

ⓘ CAUTION

If the oil level is above the area **A** do not start the engine. This could result in damage to the engine and catalytic converter. Contact a specialised workshop.


♻ For the sake of the environment

The oil level must never be above area **A**. Otherwise oil can be drawn in through the crankcase breather and escape into the atmosphere via the exhaust system.

📄 Note

Before a long trip, we recommend finding an engine oil that conforms to the corresponding VW specifications and recommend keeping it in the vehicle. This way, the correct engine oil will always be available for a top-up if needed.

Changing engine oil

Read the additional information carefully
»  page 48.

The engine oil must be changed at the intervals given in the service schedule.

We recommend that you have the engine oil changed by a Technical Service.

The oil change intervals are shown in the Maintenance Programme.

⚠ WARNING

Only change the engine oil yourself if you have the specialist knowledge required!

- Before opening the bonnet, read and observe the warnings » page 282.
- Wait for the engine to cool down. Hot oil may cause burn injuries.
- Wear eye protection to avoid injuries, such as acid burns, caused by splashes of oil.
- When removing the oil drain plug with your fingers, keep your arm horizontal to help prevent oil from running down your arm.
- Wash your skin thoroughly if it comes into contact with engine oil.
- Engine oil is poisonous! Used oil must be stored in a safe place out of the reach of children.


ⓘ CAUTION

No additives should be used with engine oil. This could result in engine damage. Any damage caused by the use of such additives would not be covered by the factory warranty.

♻ For the sake of the environment

- Because of disposal problems and the special tools and specialist knowledge required, we recommend that you have the engine oil and filter changed by a Technical Service.
- Never pour oil down drains or into the ground.
- Use a suitable container when draining the used oil. It must be large enough to hold all the engine oil.

Cooling system**Topping up coolant**



Read the additional information carefully
»  page 49

Top up coolant when the level is below the MIN (minimum) mark.

Checking coolant level

- Park the vehicle in a horizontal position.
- Switch the ignition off.
- Read off the coolant level on coolant expansion tank. When the engine is cold, the coolant level should be between the marks. When the engine is hot, it may be slightly above the upper mark.

Topping up coolant

- Wait for the engine to cool down.
- Cover the coolant expansion tank cap with a cloth and carefully unscrew it to the left **»»** .
- Top up the coolant only if there is still coolant in the expansion tank, otherwise you could **damage the engine**. If there is no coolant in the expansion tank, do not continue driving. You should obtain professional assistance **»»** .
- If there is still some coolant in the expansion tank, top up to the upper mark.
- Top up with coolant until the level becomes stable.
- Screw the cap back on correctly.

Any loss of coolant fluid normally indicates a leak in the cooling system. Take the vehicle straight to a specialised workshop to have the cooling system examined. If there are no leaks in the engine cooling system, a loss of coolant can only occur if the coolant boils and is forced out of the system as a result of overheating.

WARNING

- The cooling system is under pressure. Do not unscrew the cap on the coolant expansion tank when the engine is hot: risk of burns!

- The antifreeze and coolant fluid can be a health hazard. Therefore, the antifreeze should be stored in the original container in a safe place out of reach of children. Failure to comply could result in poisoning.

- If working inside the engine compartment, remember that, even when the ignition is switched off, the radiator fan may start up automatically, and therefore there is a risk of injury.

WARNING

If there is not enough anti-freeze in the coolant system, the engine may fail leading to serious damage.

- Please make sure that the percentage of additive is correct with respect to the lowest expected ambient temperature in the zone in which the vehicle is to be used.
- When the outside temperature is very low, the coolant could freeze and the vehicle would be immobilised. In this case, the heating would not work either and inadequately dressed passengers could die of cold.

CAUTION

Do not top up the expansion tank with coolant fluid if it is empty! Air could enter the cooling system. In this case, stop driving. Seek specialist assistance. Otherwise, there is a risk of engine damage.

CAUTION

The original additives should never be mixed with coolants which are not approved by SEAT. Otherwise, you run the risk of causing severe damage to the engine and the engine cooling system.


- If the fluid in the expansion tank is not purple but is, for example, brown, this indicates that the G13 additive has been mixed with an inadequate coolant. The coolant must be changed as soon as possible if this is the case! This could result in serious faults and engine damage.

For the sake of the environment

Coolants and additives can contaminate the environment. If any fluids are spilled, they should be collected and correctly disposed of, with respect to the environment.

Brake fluid

Topping up brake fluid

Read the additional information carefully **»»**  page 50

Checking the brake fluid level

The brake fluid level must be between the MIN and MAX markings. **»»**

However, if the brake fluid level goes down noticeably in a short time, or drops below the MIN mark, there may be a leak in the brake system. Seek specialist assistance. A warning light on the instrument panel display monitors the brake fluid level » page 106.

In right-hand drive vehicles the brake fluid reservoir is on the other side of the engine compartment.

Changing brake fluid

The regular intervals at which the brake fluid should be replaced are listed in the Maintenance Programme. We recommend you have it replaced at a SEAT Official Service, during an Inspection Service.

WARNING


- Brake fluid should be stored in the closed original container in a safe place out of reach of children. Risk of poisoning!
- If the brake fluid is left in the system for too long and the brakes are subjected to heavy use, vapour bubbles may form in the brake system. This would seriously affect the efficiency of the brakes and the safety of the vehicle. This may cause an accident.

CAUTION

Brake fluid should not come into contact with the vehicle paintwork, as it is abrasive.



Windscreen washer reservoir

Checking and topping up the windscreen washer reservoir

Read the additional information carefully »  page 50

Check the water level in the windscreen washer reservoir regularly and top up as required.

The container for the windscreen washer contains the cleaning fluid for the windscreen, the rear window and the headlight washer system*.

- Open the bonnet  » page 282.
- The windscreen washer reservoir is marked with the symbol  on the cap.
- Check there is enough windscreen water in the reservoir.

Recommended windscreen wipers

- For the hottest seasons we recommend summer G 052 184 A1 for clear glass. Proportions of the mixture in the washer fluid tank: 1:100 (1 part concentrate per 100 parts water).
- All year round, G 052 164 A2 for clear glass. Approximate proportion of the winter mixture, up to -18°C (0°F): 1:2 (1 part concentrate per 2 parts water); otherwise, a 1:4

proportion of mixture in the washer fluid tank.

Capacity

The reservoir holds approximately 3 litres in versions without headlight washer and 5 litres in versions with headlight washer.

WARNING

If the water from the windscreen washer does not contain enough anti-freeze, it may freeze on the windscreen and rear window, reducing forward and rear visibility.

- In winter, ensure the windscreen washer contains enough anti-freeze.
- In cold conditions, you should not use the windscreen wiper system unless you have warmed the windscreen with the ventilation system. The antifreeze could freeze on the windscreen and reduce visibility.

WARNING

Never mix an unsuitable antifreeze or other similar additives with the windscreen washer water. A greasy layer may be formed on the windscreen which will impair visibility.


- Use clean water with a window cleaner recommended by SEAT.
- If necessary, add a suitable antifreeze to the water in the reservoir.

ⓘ CAUTION

- Do not mix cleaning products recommended by SEAT with other products. This could lead to flocculation and may block the windscreen washer jets.
- When topping up service fluids, make absolutely certain that you fill the fluids into the correct reservoirs. Using the wrong fluids could cause serious malfunctions and engine damage!
- Not having windscreen wiper fluid reduces visibility through the windscreen, and leads to loss of visibility in headlights in models with headlight washer.

Battery

General information

Read the additional information carefully
 »  page 50.

The battery is located in the engine compartment and is almost **maintenance-free**. It is checked as part of the Inspection Service. Nevertheless, check the terminals are clean and have the correct tightening torque, especially in summer and winter.

Disconnecting the battery

The battery should only be disconnected in exceptional cases. When the battery is dis-

connected, some of the vehicle's functions are "lost" (» table on page 289). These functions will require resetting after the battery is reconnected.


Deactivate the anti-theft alarm* before you disconnect the battery. Otherwise the alarm will be triggered.

Function	Reprogramming
One-touch function of the electric windows	» page 128, One-touch opening and closing.
Remote control key	If the vehicle does not respond to the key, they should be synchronised » page 120.
Digital clock	» page 104.
ESC warning lamp	After driving for a few metres, the warning lamp goes out again.

If the vehicle is not used for long periods

The vehicle has a system for monitoring the current consumption when the engine is left unused for long periods of time » page 274. Some functions, such as the interior lights, or the remote door opening, may be temporarily disabled to prevent the battery from running flat. These functions will come back on as soon as the ignition is switched on and the engine started.






Winter conditions

During the winter, the starting power may be reduced, and if necessary, the battery should be charged »  in Important safety warnings for handling a vehicle battery on page 290

Important safety warnings for handling a vehicle battery

All work on batteries requires specialist knowledge. Please refer to a SEAT Official Service or a workshop specialising in batteries: risk of burns or exploding battery!

The battery must not be opened. Never try to change the fluid level of the battery. Otherwise explosive gas is released from the battery that could cause an explosion.

-  Wear eye protection.
-  Battery acid is very corrosive and caustic. Wear protective gloves and eye protection. In the event of electrolyte splashes, rinse off with plenty of water.
-  Fires, sparks, open flames and smoking are prohibited.
-  The battery should only be charged in a well-ventilated zone. Risk of explosion!
-  Keep children away from acid and batteries! »

⚠ WARNING

- When repairing or working on the electrical system, proceed as follows:
 - 1. Remove the key from the ignition. The negative cable on the battery must be disconnected.
 - 2. When the repair is finished, reconnect the negative pole of the battery.
- Switch off all electrical devices before reconnecting the battery. Reconnect first the positive cable and then the negative cable. Never reverse the polarity of the connections. This could cause an electrical fire.
- Ensure that the vent hose is always connected to the battery.
- Never use damaged batteries. This could cause an explosion! Replace a damaged battery immediately.

ⓘ CAUTION

- Never disconnect the battery if the ignition is switched on or if the engine is running. This could damage the electrical system or electronic components.

Charging the battery

Terminals for charging the battery are fitted in the engine compartment.

- Note the warnings **»»» ⚠** in Important safety warnings for handling a vehicle battery on page 290 and **»»» ⚠**.
- Switch off all electrical devices. Remove the ignition key.
- Raise the bonnet **»»»** page 283.
- Open the battery cover.
- Connect the charger clamps as described to the **positive pole of the battery (+)** and exclusively to an **earth on the bodywork (-)**.
- Only use a charger which is compatible for use with 12 V nominal voltage batteries. The charge must not exceed a voltage of 15 V.
- Now connect the battery charger to the power socket and switch on.
- After charging the battery: switch off the battery charger and disconnect the power socket cable.
- Finally disconnect the charger cables from the battery.
- Replace the battery cover correctly.
- Close the bonnet **»»»** page 283.

Important: Before you charge the battery make sure you read the manufacturer's instructions for using the battery charger.

⚠ WARNING

Never charge a battery that has frozen: replace battery! Failure to do so may lead to an explosion.

ⓘ Note

Use only the terminals in the engine compartment to charge the battery.

Replacing the battery

The new battery should have the same specifications (amperage, load and voltage) as the used battery.

Your vehicle is equipped with an intelligent power management system to control the distribution of electrical energy **»»»** page 274. The power management function ensures that the battery is charged much more efficiently than on vehicles without a power management system. To maintain this function after replacing the battery, we recommend that the replacement battery used is of the same make and type as the original fitted battery. To make proper use of the power management function after the battery has been changed, have the battery coded to the power management mode at a specialised workshop.

ⓘ CAUTION

- Some vehicles, for example those with the Start-Stop system* are fitted with a special battery (AGM-type or EFB-type battery). If any other type of battery is fitted, the Start-Stop function may be considerably reduced and the vehicle may not stop on repeated occasions.
- Make sure that the vent hose is always attached to the original opening on the side of the battery. Gases or battery acid can otherwise escape and possibly cause damage.
- The battery holder and clamps must always be correctly secured.
- Before starting any work on the battery, always observe the warnings listed under »» page 289, Important safety warnings for handling a vehicle battery.
- Do not forget to replace the battery coverings, where applicable. It is a protection for high temperatures. This in turn extends the vehicle service life.

🌱 For the sake of the environment

⚠ Batteries contain toxic substances including sulphuric acid and lead. They must be disposed of appropriately and must not be disposed of with ordinary household waste. Make sure disconnected batteries cannot tip over. Sulphuric acid could be spilt!

Wheels

Wheels and tyres

General notes

- When driving with **new tyres**, be especially careful during the first 500 km (300 miles).
- If you have to drive over a kerb or similar obstacle, drive very slowly and as near as possible at a right angle to the obstacle.
- Check from time to time if the tyres are damaged (punctures, cuts, cracks or dents). Remove any foreign objects embedded in the treads.
- Damaged wheels and tyres must be replaced immediately.
- Keep grease, oil and fuel off the tyres.
- Replace any missing valve caps as soon as possible.
- Mark the wheels before taking them off so that they rotate in the same direction when put back.
- When removed, the wheels or tyres should be stored in a cool, dry and preferably dark place.

New tyres

New tyres do not give maximum **grip** straight away and should therefore be “run in” by

driving carefully and at moderate speeds for about the first 500 km (300 miles). This will also increase the useful life of the tyres.

The **tread depth** of new tyres may vary, according to the type and make of tyre and the tread pattern.

Concealed damage

Damage to tyres and rims is often not readily visible. If you notice unusual **vibration** or the car **pulling to one side**, this may indicate that one of the tyres is damaged. Reduce speed immediately if there is any reason to suspect that damage may have occurred. Inspect the tyres for damage. If no external damage is visible, drive slowly and carefully to the nearest specialised workshop and have the car inspected.

Tyres with directional tread pattern

An arrow on the tyre sidewall indicates the direction of rotation on single drive tyres. Always note the direction of rotation indicated when mounting the wheel. This guarantees optimum grip and helps to avoid aquaplaning, excessive noise and wear.

Retrofitting accessories

If you wish to change or fit wheels, rims or wheel trims, we recommend that you consult with a SEAT Official Service centre for advice regarding current techniques.

Tyre useful life

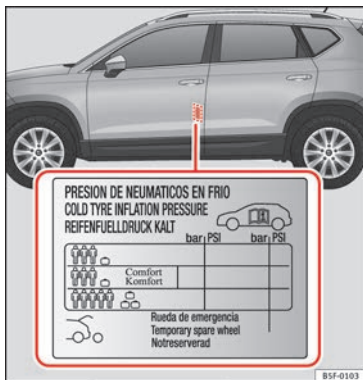


Fig. 224 Location of the tyre pressure sticker.

Correct inflation pressures and sensible driving habits will increase the useful life of your tyres.

- Check tyre pressure at least once a month, and also prior to any long trip.
- The tyre pressure should only be checked when the tyres are *cold*. Do not reduce the pressure of warm tyres.
- Adjust tyre pressure to the load being carried by the vehicle.

- In vehicles with a tyre pressure indicator, save the pressure of modified tyres
»» page 295, »» page 292.
- Avoid fast cornering and hard acceleration.
- Inspect the tyres for irregular wear from time to time.

The useful life of your tyres depends on the following factors:

Tyre pressure

The tyre inflation pressures are listed on a sticker inside the driver door pillar

»» Fig. 224.

Insufficient or excessive pressure greatly reduces the useful life of the tyres and adversely affects vehicle performance and ride. Correct inflation pressures are very important, especially at **high speeds**.

Depending on the vehicle, tyre pressure can be adjusted to medium load to improve driving comfort (“comfort” tyre pressure). When driving with comfort tyre pressure fuel consumption may increase slightly.

The tyre pressure must be adjusted according to the load the vehicle is carrying. If the vehicle is going to carry the maximum load, the tyre pressure should be increased to the maximum value indicated on the sticker

»» Fig. 224.

Do not forget the spare wheel when checking the tyre pressures: Keep this spare wheel inflated to the highest pressure required for the road wheels.

In the case of a minimised temporary spare wheel (125/70 R18) inflate to a pressure of 4.2 bar as indicated on the tyre pressure label »» Fig. 224.

Driving style

Fast cornering, heavy acceleration and hard braking (squealing tyres) all increase tyre wear.

Wheel balance

The wheels on new vehicles are balanced. However, certain circumstances may lead to imbalance (run-out), which is detected as vibrations in the steering wheel.

Unbalanced wheels should be rebalanced, as they otherwise cause excessive wear on steering, suspension and tyres. A wheel must also be rebalanced when a new tyre is fitted or if a tyre is repaired.

Incorrect wheel alignment

Incorrect running gear alignment causes excessive tyre wear, impairing the safety of the vehicle. If you notice excessive tyre wear, you should check wheel alignment at a SEAT Official Service.

WARNING

- Always adapt the tyre pressure accordingly when the vehicle load changes.
- A tyre with low air pressure has to flex a lot more when the vehicle is heavily loaded or at high speeds, therefore causing overheating to occur. Under these conditions, the tyre bead may be released or the tyre may burst. Risk of accident!

For the sake of the environment

Under-inflated tyres will increase fuel consumption.

Wear indicators

Fig. 225 Tyre tread: tread wear indicators

Tread wear indicators indicate if a tyre is worn.

The original tyres on your vehicle have 1.6 mm high “tread wear indicators” running across the tread. Depending on the manufacturer, there will be 6 to 8 of them spaced at equal distances around the tyre. Markings on the tyre sidewall (for instance the letters “TWI” or a triangle) indicate the positions of the tread wear indicators.

The minimum tread depth required by law is 1.6 mm (measured in the tread grooves next to the tread wear indicators). (Different figures may apply in other countries.)

WARNING

The tyres must be replaced at the latest when the tread is worn down to the tread wear indicators. Failure to follow this instruction could result in an accident.

- Especially in difficult driving conditions such as wet or icy roads. It is important that the tyre tread be as deep as possible and be approximately the same on the tyres of both the front and the rear axles.
- The scant driving safety due to insufficient tread depth is particularly evident in vehicle handling, when there is a risk of “aquaplaning” in deep puddles of water and when driving through corners, and braking is also adversely affected.
- The speed has to be adapted accordingly, otherwise there is a risk of losing control over the vehicle.

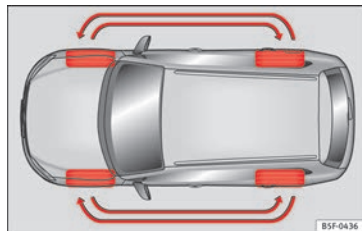
Changing wheels


Fig. 226 Interchanging tyres.

To ensure that the wear is equal on all tyres the wheels should be changed round from time to time according to the system **»» Fig. 226**. The useful life of all the tyres will then be about the same time.

New tyres or new wheels

- All four wheels must be fitted with tyres of the same type, size (rolling circumference) and preferably the same tread pattern.
- Tyres should be replaced at least in pairs and not individually (i.e. both front tyres or both rear tyres together).
- Do not use tyres whose effective size exceeds the dimensions of the factory-approved makes of tyre.

– If you wish to fit the vehicle with rims or tyres different to those installed in manufacture, it is advisable to consult a SEAT Official Service **before** purchasing them.

The tyres and wheel rims are an essential part of the vehicle's design. The tyres and rims approved by SEAT are specially matched to the characteristics of the vehicle and make a major contribution to good roadholding and safe handling»» .

The sizes of the rims and tyres approved for your vehicle are listed in the vehicle documentation (e.g. EC Certificate of Conformity or COC document¹⁾). The vehicle documentation varies depending on the country of residence.

A knowledge of tyre designations makes it easier to choose the correct tyres. The following wording can be read on the sides of the tyre:

215/60 R16 95V

This contains the following information:

215	Tyre width in mm
60	Height/width ratio in %
R	Tyre construction: Radial
16	Rim diameter in inches


95	Load rating code
V	Speed index

The **manufacturing date** is also indicated on the tyre sidewall (possibly only on the *inner* part):

DOT ... 2212 ...

it means, for example, that the tyre was manufactured in the 22nd week of 2012.

But note that with some types of tyre, the actual tyre size can differ from the nominal size marked on the tyre (for instance 215/60 R16 95 V), and there may be significant differences in the contours of the tyres, even though the tyres are marked with the same nominal size. When replacing the tyres, it is therefore important to make sure that the actual size of the new tyres does not exceed the dimensions of the factory-approved makes of tyre.

Failure to observe this requirement can affect the clearance needed for the tyres. If the tyres rub against the bodywork, in certain circumstances the tyres, running gear or bodywork and pipes may be damaged, and vehicle safety could be severely impaired»» .

If you use tyres that are approved by SEAT you can be sure that the actual tyre dimensions will be correct for your vehicle. If you

decide to fit a different type of tyre, you must obtain the appropriate manufacturer's certificate from the tyre retailer to confirm that the tyres are suitable for your vehicle. Keep this certificate in a safe place.

Your SEAT Official Service will be able to advise you on which tyres may be fitted to your vehicle.

It is best to have all servicing of wheels and tyres performed by a **specialised workshop**. They are familiar with the procedure and have the necessary special tools and spare parts as well as the proper facilities for disposing of the old tyres respecting the environment.

WARNING

- It is very important to ensure that the tyres you have chosen have adequate clearance. When selecting replacement tyres, do not rely entirely on the nominal tyre size marked on the tyre, since the effective tyre size can differ significantly depending on the manufacturer. Inadequate tyre clearance can result in damage to the tyres or the vehicle, causing a serious safety risk. Risk of accident! It may also invalidate the vehicle's registration for use on public roads.

¹⁾ COC = certificate of conformity.

- Avoid running the vehicle on tyres that are more than 6 years old. If you have no alternative, you should drive slowly and with extra care at all times.
- If wheel trims are fitted after the car is purchased, ensure that there is an adequate flow of air for cooling the brake system.

For the sake of the environment

Old tyres must be disposed of according to the laws in the country concerned.

Note


- A SEAT Service Centre should be consulted to find out whether wheels or tyres of different sizes to those originally fitted by SEAT can be fitted, and to find out about the combinations allowed between the front axle (axle 1) and the rear axle (axle 2).
- Never mount used tyres if you are not sure of their “previous history”.
- For technical reasons, it is not generally possible to use the wheels from other vehicles. In some cases, this may also be true for the same model of wheel.

Wheel bolts

The **wheel bolts** are matched to the rims. When installing different wheels (for instance alloy wheels or wheels with winter tyres) it is important to use the correct wheel bolts with

the right length and correctly shaped bolt heads. This ensures that wheels are fitted securely and that the brake system functions correctly.

The wheel bolts must be clean and turn easily.

A special adapter is required to turn the anti-theft wheel bolts* »  page 54.

Tyre monitoring systems

Introduction

WARNING

Unsuitable handling of the wheels and tyres may lead to sudden tyre pressure losses, to tread separation or even to a blow-out.

- Check tyre pressures regularly and ensure they are maintained at the pressures indicated. Tyre pressure that is too low could cause overheating, resulting in tread detachment or even burst tyres.
- Tyre pressure should be that indicated on the label when the tyres are cold at all times » page 303.
- Regularly check the cold inflation pressure of the tyres. If necessary, change the tyre pressure of the vehicle tyres while they are cold.

- Regularly check your tyres for damage and wear.
- Never exceed the maximum permitted speed or loads specified for the type of tyre fitted on your vehicle.

For the sake of the environment

Under-inflated tyres lead to increased fuel consumption and tyre wear.

Note

- Driving for the first time with new tyres at a high speed can cause them to slightly expand, which could then produce an air pressure warning.
- Only replace used tyres with those authorised by SEAT for the corresponding type vehicle.
- Do not only rely on the tyre monitoring system. Regularly check your tyres to ensure that the tyre pressure is correct and that the tyres are not damaged due to puncture, cuts, tears and impacts/dents. Remove objects from the tyres only when they have not pierced the tyres.

Tyre monitoring indicator

If a light appears



The pressure in one or more tyres has clearly reduced in comparison to the tyre pressure set by the driver or the tyre has structural damage.

Additionally, an audible warning can be heard and a text message can be seen on the instrument panel display.

Stop! Reduce speed immediately! Stop the vehicle safely as soon as possible. Avoid sudden manoeuvres and braking! Check all tyres and pressures. Replace any damaged tyres.

If flashing



System malfunction

The control lamp flashes for approximately one minute and then lights up permanently.


If tyre pressure is correct, switch the ignition off and on again. If the control lamp remains lit up, the tyre monitoring indicator can be calibrated. Have the system checked by a specialised workshop.

Several warning and control lamps light up for a few seconds when the ignition is switched on while the function is verified. They will switch off after a few seconds.

WARNING


When the tyres are inflated at different pressures or at a pressure that is too low then a tyre may be damaged resulting in a loss of

control of the vehicle and a serious or fatal accident.

- If the warning lamp  lights up, stop immediately and check the tyres.
- If the tyres are inflated at different pressures or if a tyre pressure is too low, this will increase tyre wear, negatively affecting vehicle stability and increasing braking distances.
- If tyres are inflated at different pressures or a tyre pressure is too low, a tyre may be damaged and burst resulting in a loss of control of the vehicle.
- The driver is responsible for ensuring that all of the vehicle tyres are correctly inflated to the right pressure. The recommended tyre pressure is indicated on the label
» page 303.
- The tyre monitoring system can only operate correctly if all of the tyres are inflated to the correct pressure when cold.
- Driving with tyres at the wrong pressure can damage them and result in an accident. Ensure that the tyre pressures of all the tyres correspond to the vehicle load.
- Before starting a journey, always inflate tyres to the correct pressure.
- Tyres with insufficient pressure are subjected to more flexing. Due to this, the tyre could become excessively hot, causing tread separation and also tyre blow-out.
- With an overloaded vehicle at high speed, the tyres can overheat and burst resulting in a loss of vehicle control.

- Tyre pressures which are too high or too low reduce the useful life of the tyre, affecting vehicle performance.
- If a tyre has not been punctured and it does not have to be changed immediately, drive to the nearest specialised workshop at a moderate speed and have the tyre checked and inflated to the correct pressure.

WARNING

Observe the safety warnings  in Warning and control lamps on page 107.

Note

- If excessively low tyre pressure is detected with the ignition on, an audible warning will sound. In the event that there is a fault in the system, an audible warning will sound.
- Driving on dirt tracks for a long period of time or driving in a sporty style can temporarily deactivate the TPMS. The control lamp shows a fault, but disappears when road conditions or the driving style change.

Tyre monitoring indicator

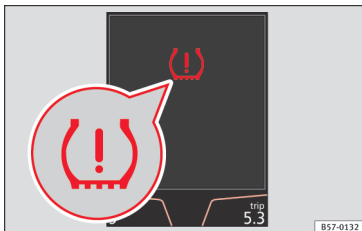


Fig. 227 Instrument panel: warning of loss of tyre pressure.

The tyre monitor indicator compares wheel revolutions and, with this information, the tread of each wheel using the ABS sensors. If the rolling circumference of one or more wheels has changed, the tyre monitoring indicator will indicate this on the instrument panel through a warning lamp and a warning to the driver » **Fig. 227**. When only one specific tyre is affected, its position within the vehicle will be indicated.

(L) Loss of pressure: Check left tyre pressure!

¹⁾ In vehicles that are not equipped with the Easy Connect system, the switch for adjusting tyre pressure is located in the centre console next to the hazard warning lights.

Wheel tread change

The wheel tread changes when:

- Tyre pressure is manually changed
- Tyre pressure is insufficient
- Tyre structure is damaged
- The vehicle is unbalanced because of a load
- The wheels on an axle are subject to a heavier load (e.g. with a heavy load).
- The vehicle is fitted with snow chains
- The temporary spare wheel is fitted
- The wheel on one axle is changed

There may be a delay in the reaction of the tyre (L) monitoring indicator or it may not indicate anything under certain circumstances (e.g. sporty driving, snow-covered or unpaved roads, or when driving with snow chains).

Calibrating the tyre monitoring indicator

After changing the tyre pressure or replacing one or more wheels, the tyre monitoring indi-

cator must be recalibrated. Do the same, for example, when the front and rear wheels are swapped.

- Switch the ignition on.
- Save the new tyre pressure in the Easy Connect system¹⁾ by using the **(CAR)** button and the **(Setup)** function button » **page 26**.

When driving, the system self-calibrates the tyre pressure provided by the driver and the wheels fitted. After a long journey with varied speeds the programmed values are collected and monitored.

With the wheels under very heavy loads, the tyre pressure must be increased to the total recommended tyre pressure before the calibration » **page 303**.

Note

- **The tyre monitoring indicator does not function when there is a fault in the ESC or ABS** » **page 173**.
- **An erroneous indication may be given when snow chains are in use because they increase the tread of the wheel.**

Temporary spare wheel

General information

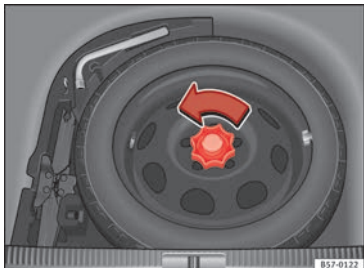


Fig. 228 Compact temporary spare wheel: raised floor panel.

The temporary spare wheel has been designed to be used for short periods of time. Have the tyres checked and replaced as soon as possible at a SEAT Official Service or at a specialised workshop.

Please note the following restrictions when using the compact temporary spare wheel. The compact temporary spare wheel is designed specifically for this model. For this reason, do not use a temporary spare wheel from a different type of vehicle.

Removing the temporary spare wheel

- Lift and hold up the floor panel to remove the temporary spare wheel.
- Turn the thumb wheel anti-clockwise » **Fig. 228.**
- Take out the temporary spare wheel.

Chains

For technical reasons, snow chains must not be used on the temporary spare wheel.

If you have a puncture on one of the front wheels when using snow chains, fit the temporary spare wheel in place of one of the rear wheels. Fit the snow chains on the rear wheel that you have removed and replace the punctured front wheel with this wheel.

⚠ WARNING

- **After fitting the temporary spare wheel, check the tyre pressures as soon as possible. Failure to do so may cause an accident. The tyre pressures are listed on the inside of the fuel tank flap.**
- **Do not drive at over 80 km/h (50 mph) when the temporary spare wheel is fitted on the vehicle: risk of accident!**
- **Never travel more than 200 km using a temporary spare wheel.**
- **Avoid heavy acceleration, hard braking and fast cornering: risk of accident!**

- **Never use more than one temporary spare wheel at the same time, risk of accident.**
- **No other type of tyre (normal summer or winter tyre) may be fitted on the compact temporary spare wheel rim.**
- **If you are driving using the spare wheel, the ACC system could automatically switch off during the journey. Switch off the system when starting off.**

Extraction of the spare wheel in vehicles with SEAT SOUND 10 speakers (with subwoofer)*

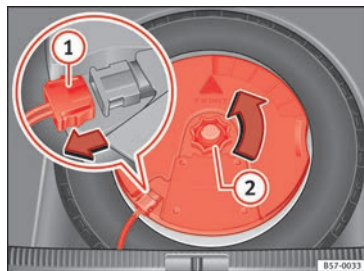


Fig. 229 In the luggage compartment: remove the subwoofer.

To remove the spare wheel, you must first remove the subwoofer.

- Lift and secure the luggage compartment floor as described in »» page 154.
- Disconnect the *subwoofer* »» Fig. 229 ① speaker cable.
- Turn the securing wheel in an anti-clockwise direction »» Fig. 229 ②.
- Remove the *subwoofer* speaker and the spare wheel.
- When re-mounting the spare tyre, place the *subwoofer* on the base of the wheel rim with care. When doing so, the tip of the “FRONT” arrow on the *subwoofer* should point forward.
- Reconnect the speaker cable and firmly rotate the securing wheel clockwise so that the *subwoofer* system and wheel are firmly in place.

Winter service

Winter tyres

- Winter tyres must be fitted **on all four** wheels.
- Only use winter tyres that are approved for your vehicle.

- Please note that the maximum permissible speed for winter tyres may be lower than for summer tyres.
- Also note that winter tyres are no longer effective when the **tread** is worn down.
- After fitting the wheels you must always check the tyre pressures. The correct tyre pressures are listed on the sticker on the inside of the fuel tank flap »» page 292.

In winter road conditions winter tyres will considerably improve vehicle handling. The design of summer tyres (width, rubber compound, tread pattern) gives less grip on ice and snow. This applies particularly to vehicles equipped with **wide section tyres** or with **high speed tyres** (code letters H, V or Y on the sidewall).

Only use winter tyres of the correct type approved for your vehicle. The sizes of these tyres are specified in the vehicle's documents (e.g. EC Certificate of Conformity or COC¹⁾). The vehicle documentation varies depending on the country of residence. See also »» page 293.

Winter tyres lose a great deal of their properties when the **tread** is worn down to a depth of 4 mm.

The performance of winter tyres is also severely impaired by **ageing**, even if the tread is still much deeper than 4 mm.

Winter tyres are subject to the following **maximum speed limits** according to speed rating code letter: »» ⚠

Speed rating code letter »» page 293	Maximum speed limit
Q	160 km/h (100 mph)
S	180 km/h (112 mph)
T	190 km/h (118 mph)
H	210 km/h (130 mph)
V	240 km/h (149 mph) (please note relevant restrictions)
W	270 km/h (168 mph)
Y	300 km/h (186 mph)

Vehicles capable of exceeding these speeds must have an appropriate **sticker** attached so that it is visible to the driver. Suitable stickers are available from the SEAT Official Service and specialised workshop. Please note the regulations to this effect in your country.

“All-weather” tyres can also be used instead of winter tyres.



¹⁾ COC = certificate of conformity.

Using winter tyres with V-rating

Please note that the generally applicable 240 km/h (149 mph) speed for winter tyres with the letter V is subject to **technical restrictions; the maximum permissible speed for your vehicle may be significantly lower.**

The maximum speed limit for these tyres depends directly on the maximum axle weights for your car and on the listed weight rating of the tyres being used.

It is best to contact a SEAT Official Service to check the maximum speed which is permissible for the V-rated tyres fitted on your car on the basis of this information.

WARNING

Exceeding the maximum speed permitted for the winter tyres fitted on your car can cause tyre failure, resulting in a loss of control of the vehicle – risk of accident.

For the sake of the environment

Summer tyres should be fitted again as soon as possible after the winter period; they give better handling on roads which are free of snow and ice. Summer tyres perform with less rolling noise, tyre wear and – most important – reduce fuel consumption.

Technical data

Technical specifications

Important

The information in the vehicle documentation always takes precedence over the information in this Instruction Manual.

All technical specifications provided in this documentation are valid for the standard model in Spain. The vehicle data card included in the Maintenance Programme or the vehicle registration documents shows which engine is installed in the vehicle.

The figures may be different depending whether additional equipment is fitted, for different models, for special vehicles and for other countries.

Abbreviations used in the Technical Specifications section

kW	Kilowatt, engine power measurement.
PS	Pferdestärke (horsepower), formerly used to denote engine power.
rpm	Revolutions per minute - engine speed.
Nm	Newton metres, unit of engine torque.
CZ	Cetane number, indication of the diesel combustion power.
RON	Research octane number, indication of the knock resistance of petrol.

Vehicle identification data

1	1. VSSZZZXXXXXXXXXXX
2	2. XXX XXX
	XXXX X.X XXX
3	3. XXXX
	XXXX XX
4	4. X3B B0A D38 80C 1AT 8GJ
	J1D CGA HH7 -- 1G6 1NL
	8YM 8L7 8RM 8BG 8WD 8TC
	-- 27G
	2B2 5SJ 5RQ QG1
	7MG 639

Fig. 230 Vehicle data sticker (luggage compartment).



Fig. 231 Chassis number.

VIN in the Easy Connect

- Select: Function button **CAR** > control button **(Car)* Systems > Service & Control > Chassis number.**

Chassis number

The VIN is located in the Easy Connect, on the vehicle data sticker and under the windscreen, on the driver side »» **Fig. 231**. Additionally, the chassis number is located in the engine compartment, on the right-hand side. The number is engraved on the top side rail, and is partially covered.

Type plate

The type plate is located on the right side door pillar. Vehicles for certain export countries do not have a type plate.

Vehicle data sticker

The vehicle data sticker is under the carpet trim in the luggage compartment, in the spare wheel well. A sticker with the vehicle data is attached to the inside cover of the Maintenance Programme.

The following information is provided on the vehicle data sticker: » Fig. 230

- ① Vehicle identification number (chassis number)
- ② Vehicle type, model, capacity, engine type, finish, engine power and gearbox type
- ③ Engine code, gearbox code, external paint code and internal equipment code
- ④ Optional extras and PR numbers

Identifying letters

The identifying letters of the engine can be viewed on the instrument panel when the engine is switched off and the ignition is on.

- Hold down the **0.0/SET** ④ » Fig. 115 button for more than 15 seconds.

Information on fuel consumption

Fuel consumption

Approved consumption values are derived from measurements performed or supervised by certified EU laboratories, according to the legislation in force at the time (for more information, see the Publications Office of the European Union on the EUR-Lex website: © European Union, <http://eur-lex.europa.eu/>) and apply to the specified vehicle characteristics.

The values relating to fuel consumption and CO₂ emissions can be found in the documentation provided to the purchaser of the vehicle at the time of purchase.

Fuel consumption and CO₂ emissions depend on the equipment/features of each individual vehicle, as well as on the driving style, road conditions, traffic conditions, environmental conditions, load or number of passengers.

Note

In practice, and considering all the factors mentioned here, consumption values can differ from those calculated in the current European regulations.

Weights

Kerb weight refers to the basic model with a fuel tank filled to 90% capacity and without optional extras. The figure quoted includes 75 kg to allow for the weight of the driver.

Special versions, optional equipment fittings or retro-fitting accessories will increase the weight of the vehicle » ⚠.

⚠ WARNING

- **Please note that the centre of gravity may shift when transporting heavy objects; this may affect vehicle handling and lead to an accident. Always adjust your speed and driving style to suit road conditions and requirements.**
- **Never exceed the gross axle weight rating or the gross vehicle weight rating. If the permissible axle load or the permissible total weight is exceeded, the driving characteristics of the vehicle may change, which could lead to accidents, injuries and damage to the vehicle.**

Trailer mode

Trailer weights

Trailer weight

The trailer weights and drawbar loads approved are selected in intensive trials according to precisely defined criteria. The approved trailer weights are valid for vehicles in the EU for maximum speeds of 80 km/h (50 mph) (in certain circumstances up to 100 km/h (62 mph)). The figures may be different in other countries. All data in the official vehicle documentation takes precedence over these data at all times »» ⚠.

Drawbar loads

The *maximum* permitted drawbar load on the ball joint of the towing bracket must not exceed **80 kg**.

In the interest of road safety, we recommend that you always tow approaching the maximum drawbar load. The response of the trailer on the road will be poor, if the drawbar load is too small.

If the maximum permissible drawbar load cannot be met (e.g. with small, empty and light-weight single axle trailers or tandem axle trailers with a wheelbase of less than 1 metre), a minimum of 4% of the actual trailer weight is legally required for the drawbar load.

⚠ WARNING

- For safety reasons, you should not drive at speeds above 80 km/h (50 mph) when towing a trailer. This also applies in countries where higher speeds are permitted.
- Never exceed the maximum trailer weights or the drawbar load. If the permissible axle load or the permissible total weight is exceeded, the driving characteristics of the vehicle may change, leading to accidents, injuries and damage to the vehicle.

Wheels

Tyre pressure, snow chains, wheel bolts

Tyre pressures

The sticker with the tyre pressure values can be found on the inside of the fuel tank flap. The tyre pressure values given there are for *cold* tyres. The slightly raised pressures of warm tyres must not be reduced. »» ⚠

The pressure for *winter tyres* is 0.2 bar (2.9 psi / 20 kPa) higher than that of summer tyres.

Snow chains

Snow chains may be fitted only to the front wheels, and only for the following tyres:

215/60 R16	Chains with links of maximum 15 mm
215/55 R17	Chains with links of maximum 15 mm
215/50 R18	Chains with links of maximum 15 mm
Other dimensions do not allow chains	

Wheel bolts

After the wheels have been changed, the **tightening torque** of the wheel bolts should be checked as soon as possible with a torque wrench »» ⚠. The tightening torque for steel and alloy wheels is **140 Nm**.

⚠ WARNING

- Check the tyre pressure at least once per month. Checking the tyre pressure is very important. If the tyre pressure is too high or too low, there is an increased danger of accidents - particularly at high speeds.
- If the tightening torque of the wheel bolts is too low, they could loosen while the vehicle is in motion. Risk of accident! If the tightening torque is too high, the wheel bolts and threads can be damaged.

i Note

We recommend that you ask your Technical Service for information about appropriate wheel, tyre and snow chain size.

Engine data

Petrol engine 1.0 85 kW (115 PS)

Power output in kW (PS) at rpm	Maximum torque (Nm at rpm)	No. of cylinders/displacement (cm ³)	Fuel
85 (115)/5,000-5,500	200/2,000-3,500	3/999	Super 95 RON/Normal 91 RON ^{a)}

^{a)} Slight power loss.

Outputs and weights	
Top speed (km/h)	183
Acceleration from 0-80 km/h (seconds)	^{a)}
Acceleration from 0-100 km/h (seconds)	^{a)}
Maximum authorised weight (kg)	1,830
Weight in running order (with driver) (kg)	1,280
Maximum authorised weight on front axle (kg)	940
Maximum authorised weight on rear axle (kg)	940
Permitted roof load (kg)	75
Maximum trailer weight without brakes (kg)	640
Weight of trailer with brakes, gradients up to 8% (kg)	1,500
Weight of trailer with brakes, gradients up to 12% (kg)	1,300

^{a)} Data not available as this edition goes to print.

Technical specifications

Diesel engine 1.6 85 kW (115 PS)

Power output in kW (PS) at rpm	Maximum torque (Nm at rpm)	No. of cylinders/displacement (cm ³)	Fuel
85 (115)/3,250-4,000	250/1,500-3,250	4/1,598	Diesel according to standard EN 590, min. 51 CZ

Outputs and weights	
Top speed (km/h)	184
Acceleration from 0-80 km/h (seconds)	a)
Acceleration from 0-100 km/h (seconds)	a)
Maximum authorised weight (kg)	1,910
Weight in running order (with driver) (kg)	1,375
Maximum authorised weight on front axle (kg)	1,030
Maximum authorised weight on rear axle (kg)	930
Permitted roof load (kg)	75
Maximum trailer weight without brakes (kg)	680
Weight of trailer with brakes, gradients up to 8% (kg)	1,700
Weight of trailer with brakes, gradients up to 12% (kg)	1,500

a) Data not available as this edition goes to print.

Technical data

Diesel engine 2.0 110 kW (150 PS)

Power output in kW (PS) at rpm	Maximum torque (Nm at rpm)	No. of cylinders/displacement (cm ³)	Fuel
110 (150)/3,500-4,000	340/1,750-3,000	4/1,968	Diesel according to standard EN 590, min. 51 CZ

Outputs and weights	2WD	4WD
Top speed (km/h)	202	196
Acceleration from 0-80 km/h (seconds)	a)	a)
Acceleration from 0-100 km/h (seconds)	a)	a)
Maximum authorised weight (kg)	1,950	2,100
Weight in running order (with driver) (kg)	1,417	1,548
Maximum authorised weight on front axle (kg)	1,060	1,080
Maximum authorised weight on rear axle (kg)	940	1,070
Permitted roof load (kg)	75	75
Maximum trailer weight without brakes (kg)	700	750
Weight of trailer with brakes, gradients up to 8% (kg)	1,900	2,000
Weight of trailer with brakes, gradients up to 12% (kg)	1,900	2,000

a) Data not available as this edition goes to print.

Dimensions

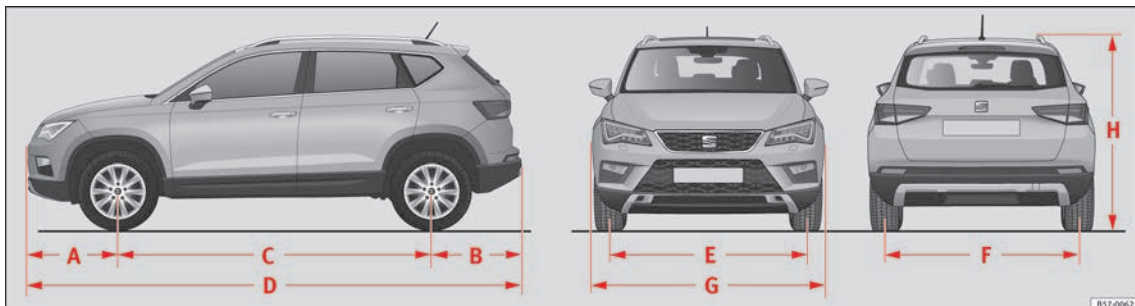


Fig. 232 Dimensions

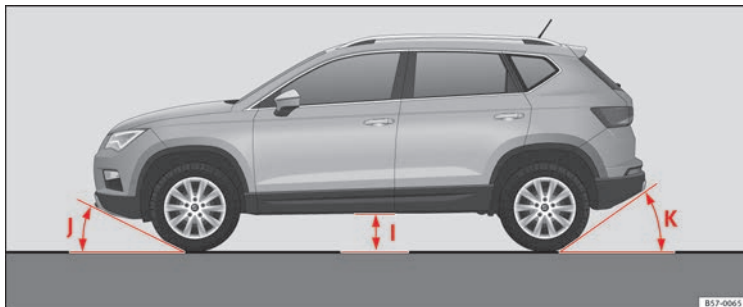


Fig. 233 Angles and ground clearance



Technical data

»» Fig. 232, »» Fig. 233		2WD	4WD
A	Front projection (mm)	868	868
B	Rear projection (mm)	857	865
C	Wheelbase (mm)	2,638	2,630
D	Length (mm)	4,363	
E	Front ^{e)} track (mm)	1,576	1,572
F	Back ^{e)} track (mm)	1,541	1,544
G	Width (mm)	1,841	
H	Height at kerb weight (mm)	1,601 ^{b)} 1,615 ^{c)}	1,611 ^{b)} 1,625 ^{c)}
I	Ground clearance between the axles (mm)	176	189
J	Front projection angle limited by the bumper	maximum 19.4°	maximum 20.6°
K	Rear projection angle limited by the bumper	maximum 27.9°	maximum 25.5°
	Turning radius (m)	10.8	

a) This data will change depending on the type of wheel rim.

b) Distance to the roof.

c) Dimension to the roof bars.

Index

A

- ABS
see Anti-lock brake system 173
- ACC 197
radar sensor 200
- Accessories 148, 265
- Adaptive cruise control 197
indications on the display 199
malfunction 198
radar sensor 200
special driving situations 205
warning and control lamp 199
- Adaptive Cruise Control
deactivating temporarily 205
operating 201
- AdBlue
control lamp 279
information 279, 280
maximum filling capacity 280
refilling 280
specification 280
tank capacity 279, 280
warning lamp 279
- additional electrical appliances (efficiency programme) 34
- Adjusting
front head restraints 66
front seats 143
- Adjusting the head restraints
front head restraints 143
- Adjustment
CAR menu 108
front head restraints 143
- lights 137
rear head restraints 66, 143
seats 63
- Airbag covers 15
- Airbags 73
description 74
- Airbag system 15, 73
activation 74
deactivation of front airbag 77
description 74
front airbags 15, 75
functioning 74
head-protection airbags 17
Knee airbag 16
side airbags 16
- Air conditioning
Climatronic 42, 156
heating and fresh air 46
manual air conditioning 44
User instructions 158
- Air conditioning system
auxiliary heater 161
- Air outlets 159
- Air recirculation 160
- Alcantara: cleaning 272
- Ambient lighting 138
- Anti-freeze 49
- Anti-lock brake system 173
- Anti-puncture 53, 83
- Anti-puncture kit 53, 83
Check after 10 minutes 85
- Anti-puncture set 83
- Anti-slip regulation 173
- Anti-theft alarm 112, 121
trailer 260
vehicle interior monitoring and anti-tow system 123
- Anti-theft security system 9, 112, 119
- Anti-theft system
trailer 260
- Anti-tow protection 123
- Anti-trap function
sun blind (sunroof) 130
sunroof 130
- Area View 247
see area View 247
- Area View system
instructions for use 249
menus 250
modes 250
screen 249
Special characteristics 249
- Aspects to take into account before starting the vehicle 62
- Assistance systems
ACC 197
adaptive cruise control 197
Area View 247
Auto Hold function 191
blind spot detector (BSD) with parking assistance (RCTA) 220
Cruise control system 193
Emergency Assist 218
Front Assist 207
Hill Descent Control 190
parking assistance (RCTA) 220
Pedestrian Monitoring system 212
rear parking aid 244
Traffic Jam Assist 216
traffic sign detection system 228
tyre monitoring 296
tyre monitoring indicator 297
- Assistance Systems
fatigue detection 231
tyre monitoring systems 295
- Assisted starting 58

- Assist systems
 Park Assist 232
 parking system Plus 239
 speed limiter 194
- Audible signal
 lights 131
- Audible warning signal
 seat belt not fastened 68
 warning and control lamps 106
- Auto Hold 191
- Auto Hold function 191
- Auto Lock (central locking) 112
- Automatic car washes
 switching the Auto Hold function off 192
- Automatic dipped beam control 132
- Automatic gear
 safety interlock for ignition key 165
- Automatic gearbox 177
 backup programme 183
 downhill speed control 182
 driving tips 180
 kick-down feature 181
 launch control programme 181
 manual release of selector lever 41
 selector lever lock 178
 selector lever positions 177
 Steering wheel with gearshift paddles 179
 tiptronic 177, 179
 towing 87
- AUX-IN 111
- Auxiliary heater 161
 activating 163
 electric consumers 164
 operating instructions 164
 programming 163
 remote control 162
 remote control range 163
- special features 162
 switching off 161
 switching on 161
 things to note 164
- B**
- Battery 120
 replacement in the remote control (auxiliary heater) 162
- Before starting the vehicle 62
- Belt tightening 72
- Bench seat 146
- Bicycle rack
 Fitting on the retractable tow hitch 258
 maximum load 258
- Biodiesel 278
- Blind spot detector (BSD) 220
 control lamps 220
 driving situations 223
 indication in the external rear view mirror 221
 malfunction 220
 operating 221
 towing 225
- Bonnet 11, 282
 opening the bonnet 283
- Brake
 emergency braking function 170
 brake fluid 50
- Brakes 172
 brake fluid 287
 brake servo 172
 electronic parking brake 170
 new brake pads 172
- Braking
 front assist 173
- BSD
 see Blind spot detector (BSD) 220
- C**
- Camera
 cleaning 268
 cleanliness 228
 Lane Assist 215
- Capacities 48
 AdBlue tank 279, 280
 fuel tank 106
 windscreen washer water 288
- Car-care products 266
- Catalytic converter 186
 malfunction 186
- CCS 36
- CD-ROM player (navigation) 148
- Central locking
 anti-theft alarm 121
 central locking switch 115
 Electric windows 127
 Keyless Access 116
 Manual locking 10
 programming 115
 remote control key 114
 selective unlocking system 114
 sliding/tilting sunroof 127
- Central locking system 112
- Central wheel trim 54
- Cetane number (diesel fuel) 278
- Changing
 parts 265
- changing a bulb
 dipped beam 94
 rear bulb in the side panel 96
 rear light in the rear lid 97
- Changing a bulb 93
 fog light 95
 main beam 94
 turn signal 94

- Changing a wheel 54
 subsequent work 56
- Changing bulbs
 number plate light 98
- Changing gear
 engaging gears (manual gearbox) 176
- Changing settings
 CAR menu 26
- Changing the blades 85
- Changing the wiper blades 60
- Charging the battery 290
- Checking levels
 engine compartment 282
- Child-proof locking
 electric windows 126
- Child seat
 Categorisation in groups 81
- Child seats 17, 80
 ISOFIX system 19
 safety instructions 17, 79
 securing with seat belt 18
 Top Tether system 19, 22
- City Emergency braking function 211
- Cleaning 266
 alcantara 272
 carbon parts 269
 Easy Connect control panel 270
 Exhaust pipe 269
 fabrics 270
 leather 271
 natural leather 271
 plastic parts 270
 Plastic parts 268
 Radio display 270
 seat belts 272
 trims 268
 washing the vehicle 266
- wheels 269
 windows 269
- Climatronic 42
- Close 112
 rear lid 123
 sunroof 129
 windows 126
- Closing 112
 bonnet 283
 rear lid 123
 sun blind (sunroof) 129
 sunroof 129
 windows 126
- Clutch (warning lamp) 183
- Coming Home 134
- Connectivity Box 111
- Contact 165
- Control and warning lamps
 diesel particulate filter 186
 emission control 187
 remote control (auxiliary heater) 162
- Control lamps
 AdBlue 279
 blind spot detector (BSD) 220
 Hill Descent Control 190
 parking assistant (RTA) 220
 speed limiter 194
 tow hitch 258
 towing bracket 256
- Controls and displays
 general instrument panel 101
- Controls on the steering wheel
 operating the audio system and telephone .. 109
- Coolant
 checking level 286
- cooling system
 checking coolant 286
- Cooling system
 Coolant temperature gauge 105
 topping up coolant 286
- Cornering
 lights 134
- Correct position 63
- Correct sitting position
 front passenger 64
 rear seat passengers 65
- Cruise control 36, 193
 operation 193
- Cruise control system 193
 Warning and indication lamp 193
- ## D
- Dangers in not using the seat belt 70
- Dash panel 38
- Data sticker 301
- Deactivating the front passenger front airbag ... 15
- Deactivation of front airbag 77
- Defective bulbs
 changing a bulb 93
- Diesel
 diesel particulate filter 186
 engine oil 284
 preheating 165
 refuelling 278
- Diesel particulate filter
 malfunction 186
- Digital clock 102
- Dimensions 307
- Direction of rotation
 tyres 56
- Display 102, 103
- Display messages
 speed limiter 194

- Display of traffic signs on the instrument panel
 - activate 229
 - deactivate 229
- Disposal
 - Seat belt tensioners 72
- Distance control
 - see Adaptive cruise control 197
- Door cylinder 9
- Door handle 9
- Door lock 9
- Door release lever 101
- Doors
 - Childproof locks 120
 - opening and closing 9
- Downhill speed control 182
- Downhill speed control function 182
- Drawer 147
- Drink holders 147
- Driver
 - see Correct sitting position 63, 64, 65
- Driver information system
 - CD/radio indication 29
 - engine oil temperature display 34
 - Operation with the windscreen wiper lever ... 29
- Driving
 - Driving abroad 136
 - driving through water 187
 - towing 90
- Driving abroad
 - headlights 136
- Driving data 29
 - data summary 33
 - memory 33
- Driving in winter
 - trailer 255
- Driving mode 226
- Driving on flooded roads 187
- Driving profile 226
- Driving safety 62
- DSG 177
- Duplicate keys 113
- Dust and pollen filter 156
- Dynamic headlight range control 137
- E**
- E10
 - see Ethanol (fuel) 277
- Easy Connect 26, 108
- Easy Open 116
 - special characteristics 118
- Economical
 - driving 185
- EDL
 - see Electronic differential lock 173
- Efficiency programme
 - additional electrical appliances 34
 - saving tips 34
- Electric windows 12, 126
 - convenience opening and closing 127
- Electromechanical steering 273
 - lamp 273
- Electronic differential lock 173
- Electronic immobiliser 9
- Electronic self-locking 173
- Electronic stability control (ESC) 173
- Electronic torque management (XDS) 173
- Emergencies 83
 - Anti-puncture kit 83
 - automatic gearbox backup programme 183
 - bulbs 52
 - changing a wheel 54
 - emergency towing of the vehicle 57
 - fuses 51
 - hazard warning lights 135
 - jump leads 58
 - Manual unlocking and locking 85
 - puncture 52
 - replacing a blown fuse 51
 - replacing the battery 290
 - vehicle tool kit 83
- Emergency Assist 218
 - see Emergency Assist 218
 - switching off 218
 - switching on 218
- Emergency braking function 170
- Emergency braking warning 136
- Emergency operation
 - passenger door 10
 - Selector lever 41
- Emission control system
 - control lamp 187
- Emissions data 301
- Engine
 - assisted starting 58
 - noises 169
 - preheating 165
 - running in 184
 - Start-Stop system 188
 - starting 165
 - starting up (driver messages with the mechanical contact) 165
 - switching off (key) 166
- Engine and ignition
 - automatic ignition switch-off 167
 - My Beat 169
 - preheating the engine 168
 - starting the engine 168
 - starting the engine with Press & Drive 168
 - stopping the engine 169
- Engine compartment 11, 282
 - battery 50, 289
 - brake fluid 50, 287

- closing the bonnet 283
- coolant 49, 286
- engine oil 48, 285
- opening the bonnet 283
- safety notes 282
- windscreen washer reservoir 288
- Windscreen washer reservoir 50
- Engine coolant 49
- G 12 plus-plus 49
- G 13 49
- specifications 49
- Engine data 304
- Engine fault
 - control lamp 187
- Engine management 186
- control lamp 187
- Engine oil 48, 284
- changing 284, 286
- Checking oil level 285
- consumption 285
- dipstick 285
- inspection service 284
- maintenance intervals 284
- Oil properties 49
- Specifications 284
- temperature display 34
- topping up 285
- Environment
 - ecological driving 185
 - Environmental compatibility 184
- Environmental tips
 - Filling the tank 277
 - refuelling 276
- Equipment 148, 265
- ESC
 - electronic stability control (ESC) 173
 - multi-collision brake 174
 - Sport Mode 175
- Ethanol (fuel) 277
- Exhaust gas purification system
 - catalytic converter 186
 - diesel particulate filter 186
- Exhaust pipe: Cleaning 269
- Exhaust purification system (diesel) 279
- Exiting a parking space with Park Assist 238
- Exterior lighting
 - changing a bulb 93
- Exterior mirrors
 - adjusting 14
 - driving with a trailer 257
- Exterior rear view mirrors
 - exterior 141
 - heated 141
- Exterior view 5, 6
- External aerial 265
- F**
 - Fastening rings 151
 - Fatigue detection 231
 - Filling the tank 276
 - fuel gauge 106
 - Floor mats 67
 - Fluid Level control 48
 - Fog light bulb 95
 - Four-wheel drive
 - snow chains 274
 - towing 87
 - winter tyres 274
 - Four wheel drive 273
 - Front airbags 15, 75
 - Front armrest 145
 - Front assist 173
 - Front Assist 207
 - City Emergency braking function 211
 - malfunction 208
 - on-screen messages 208
 - operating 209
 - radar sensor 209
 - system limitations 210
 - temporarily switching off 210
 - see also* Front Assist system 207
 - Front Assist monitoring system
 - malfunction 208
 - on-screen messages 208
 - Front Assist Monitoring system
 - City Emergency braking function 211
 - radar sensor 209
 - Front Assist Monitoring System
 - system limitations 210
 - Front Assist system
 - temporarily switching off 210
 - Front passenger front airbag
 - control lamp 78
 - deactivation 15, 78
 - Front seat
 - manual adjustment 12
 - Fuel 48, 277
 - consumption 302
 - diesel 278
 - ethanol 277
 - fuel gauge 106
 - refuelling 277
 - saving 185
 - Fuel consumption
 - Switching off using inertia 185
 - why does fuel consumption increase? 186
 - Fuel tank cap
 - opening and closing 48

- Fuel tank flap
 - opening and closing 48
- Full-LED Headlights 93
- Function Coming Home 134
- Function Leaving Home 135
- Fuses 51, 90
 - fuse box 91
 - identifying blown fuses 51
 - Identifying by colours 51
 - Preparation before replacing 51
 - replacing 51
- G**
- Gear-change indicator 31
- Gearbox DSG
 - see Automatic gearbox 177
- Gearbox lever 40
- Gear change 40
 - automatic 41
 - Kick-down 227
 - manual gearbox 176
 - Manual gear change 40
- Gear engaged 40
- Gear recommendation 31
- Gearshift paddles (automatic gearbox) 179
- General instrument panel
 - Control lamps 38
 - controls and displays 101
 - Engine compartment 282
 - Warning lamps 38
- Glove compartment 148
- H**
- Hand brake
 - See Parking brake 170
- Hazard warning lights 24, 135
- HDC
 - see Hill Descent Control 190
- Head-on collisions and the laws of physics 70
- Head-protection airbags
 - description 17
 - safety instructions 76
- Headlight range control 137
- Headlights
 - driving abroad 136
 - Headlight washers 139
- Head restraints 13
 - adjustment 143
 - front head restraints 66
 - rear head restraints 66
- Headrests 13
 - adjustment 143
 - front 66
- Heated rear window 43, 45
- Heating and fresh air 46
- Hill Descent Control
 - control lamp 190
- Horn 101
- How to jump start 58
 - description 59
- I**
- Identifying letters on engine 301
- Ignition 23, 165
- Ignition lock 23, 165
 - see Starter button 167
- Incorrect sitting position 65
- Indications on display
 - traffic signs 229
- Indications on the
 - ACT 185
- Indications on the display 103
 - adaptive cruise control 199
 - assist systems submenu 32
 - compass 104
 - distance travelled 104
 - doors, bonnet and rear lid open 32
 - Driver information system 29
 - driving data 33
 - ECO 104
 - engine oil 34
 - MKB 105
 - outside temperature 31
 - recommended gear 104
 - second speed display 104
 - selector lever positions 104, 177
 - service intervals 35
 - speed warning 104
 - Start-Stop 104
 - time 104
 - tyre monitoring 297
 - warning and control lamps 199
 - warning and information messages 32
- Indications on the screen
 - SEAT Drive Profile 225
- Inertia mode 182
- Infotainment system 26
- Inspection 284
- Inspection service 284
- Instrument cluster 102
- Instrument panel 102
 - display 102, 103
 - instruments 102
 - menus 29
 - odometer 105
 - service interval indication 35
 - warning and control lamps 106
- Interior lights 24

- Interior view
left guide 7
right-hand drive 8
- ISOFIX 19, 21
- ISOFIX system 19
- ISOFIX System 21
- J**
- Jack 54, 83
mounting points 55
- Jump leads 58
- K**
- Key-operated switch 77
- Keyless-Entry
see Keyless Access 116
- Keyless-Exit
see Keyless Access 116
- Keyless Access
Easy Open 116
Keyless-Entry 116
Keyless-Exit 116
Press & Drive 167
special characteristics 119
starting the engine 168
unlocking and locking the vehicle 116
- Keyless Access locking and ignition system
see Keyless Access 116
- Keys
assign key 113
car key 113
driver messages (mechanical contact) 165
remote control 113
replacing the battery 120
spare key 113
Synchronising 120
unlocking and locking 9, 114
- Kick-down
automatic gearbox 181
manual gear change 227
- Knee airbags
safety information 16
- L**
- Lane Assist 213
cleaning the camera area 268
- Lane Assist system
see Lane Assist 213
- Launch control programme (automatic gearbox) 181
- Leather: care 271
- Leaving Home 135
- Lifting the vehicle 55
- Light Assist 132
- Lighting of the instrument panel 137
- Lights 23, 131
audible signals 131
AUTO 132
changing a bulb 93
coming home 134
cornering lights 134
Daytime running lights 131
dipped beam headlight 131
Fog light 134
Hazard warning lights 24
headlight range control 137
interior lights 138
leaving home 135
light control 131
lighting of the instruments 137
lighting of the switches 137
main beam lever 131
main beam lights 131
main beams 24
motorway light 136
- parking lights 136
- reading lights 138
- side lights 131
- switch 23
- turn signal lever 131
- Load compartment in the luggage compartment
see Loading the luggage compartment 149
- Loading the luggage compartment 149
- Loading the vehicle
fastening rings 151
luggage compartment 10
roof carrier system 156
tailboard for transporting long items 151
trailer 261
- Locking and unlocking
in the door cylinder 9
with the central locking switch 115
- Luggage 149
- Luggage compartment 10
automatic lock 125
electric opening and closing 123
luggage compartment lighting 138
luggage compartment variable floor 153
net bag 152
rear shelf 150
special characteristics of the electric rear lid 124
storing the rear shelf 150
Unlocking manually 11
see also Loading the luggage compartment 149
- Luggage compartment floor 153
- Luggage compartment variable floor 153
- Luggage net
luggage compartment 152
- Lumbar support 143
- M**
- Main beam assist 132

- Main beam lever 131
 Main panel
 turn signal and main beam lever 131
 Maintenance intervals 284
 malfunction
 catalytic converter 186
 Front Assist 208
 Malfunction
 Adaptive cruise control 198
 clutch 183
 diesel particulate filter 186
 front assist monitoring system 208
 gearbox 183
 towing bracket 260
 Manual air conditioning 44
 Manual gearbox 176
 towing 87
 Manual unlocking and locking 85
 Maximum trailer weight
 loading the trailer 261
 Mirror 141
 Mobile 265
 Mobile telephones 265
 Model plate 301
 Modifications 265
 Multi-collision Brake 174
 Multimedia 111
 My Beat 169
- N**
- Natural leather
 cleaning 271
 Navigation system
 CD-ROM player 148
 Net bag
 luggage compartment 152
- Noises
 Adaptive cruise control 198
 auxiliary heater 164
 brakes 172
 ESC 174
 parking brake 171
 tyres 56, 291
 Number of seats 68
- O**
- Octane rating (petrol) 277
 Odometer 105
 partial 102
 reset button 105
 total 102
 Oil change 286
 Oil properties 49
 On-screen messages
 Front Assist monitoring system 208
 One-touch opening and closing
 Electric windows 128
 Open and close 112
 rear lid with electric opening and closing 123
 windows 126
 Opening 112
 bonnet 283
 fuel tank flap 276
 rear lid 123
 sun blind (sunroof) 129
 sunroof 129
 windows 126
 Opening and closing 9
 bonnet 283
 by remote control 114
 fuel tank flap 276
 in the door cylinder 9
 rear lid of the luggage compartment 10
 sunroof 129
 with the central locking switch 115
 Opening manually
 rear lid 11
 Operating malfunction
 Park Assist 232
 sunroof 128
 Outside temperature 31
- P**
- Paint 268
 care 268
 damage 269
 Paintwork
 code 301
 Panoramic sliding sunroof
 convenience opening and closing 127
 see also Sunroof 128
 Park Assist 232
 automatic braking intervention 239
 automatic interruption 233
 conditions for exiting a parking space 238
 driving with a trailer 244
 exiting a parking space (only for parallel
 spaces) 238
 operating malfunction 232
 parallel parking 236
 parking conditions 236
 perpendicular parking 236
 see Park Assist 232
 stopping prematurely 233
 Parking 171, 180
 with Park Assist 236
 Parking aid
 Rear parking aid 244

- Parking Aid
 - adjusting the display and audible warnings 243, 246
 - automatic activation 242
 - fault 243, 247
 - sensors and camera: cleaning 268
 - towing bracket 247
 - visual indication 242, 246
- Parking aid system
 - see Parking aid 239, 244
- Parking assistance
 - parking system plus 239
 - see Park Assist 232
 - surroundings warning 239
- Parking assistance (RCTA) 220
- Parking assistant 224
- Parking assistant (RTA) 224
 - control lamp 220
- Parking brake 170
 - activate 170
 - automatic activation 170
 - automatic release 170
 - emergency braking function 170
 - release 170
- Parking distance warning system
 - see Parking aid 239, 244
- Parking (automatic gearbox) 180
- ParkPilot
 - see Parking aid 239, 244
- Particulate filter (diesel) 186
- Parts 265
- Passenger
 - see Correct sitting position 63, 64, 65
- Passenger door manual locking 10
- Pedals 67
- Pedestrian Monitoring system 212
- Pedestrian protection
 - see Pedestrian Monitoring system 212
- Petrol
 - additives 277
 - refuelling 277
- Plastic parts: cleaning 268, 270
- Polishing 268
- Positioning seat belts
 - during pregnancy 72
 - seat belts 72
- Power 148
- Power Management 274
- Power sockets
 - trailer 259
- Power steering
 - see Electromechanical steering 273
- Pre-heating system
 - control lamp 187
- Preheating 165
- Preheating the engine 168
- Press & Drive
 - starter button 167
 - starting the engine 168
- Puncture
 - action 52
- R**
- Racks 148
- Radar sensor 200, 209
- Radio-operated remote control
 - see Keys 113
- Radio display: cleaning 270
- Radio transmitters 265
- Rain sensor 140
 - control of the function 140
- Raising the vehicle 55
- RCTA
 - see Parking assistance (RCTA) 220
- Rear
 - headrests 66
- Rear Assist 252
 - instructions for use 253
 - parking 254
 - screen 253
 - special characteristics 253
- Rear Assist system 252
- Rear bulbs in the side panel
 - disassemble the rear light 96
- Rear lid 10, 11
 - see also Luggage compartment 123
- Rear lights in the rear lid
 - disassemble de bulb holder 97
- Rear parking aid 244
- Rear seat backrest
 - folding down 146
 - folding down and lifting the backrest 146
 - lifting 146
- Rear seat passengers
 - see Correct sitting position 63, 64, 65
- Rear shelf
 - storing 150
- Rear View Camera 252
- Rear view mirror
 - anti-dazzle 141
- Rear view mirrors
 - adjusting the exterior rear view mirrors 141
- Refuelling
 - opening fuel tank flap 276
- Remote control key
 - unlocking and locking 114
- Remote control (auxiliary heater) 162
- replacing the battery 162
- Removing and installing head restraints 143
- Repair work 265
- Replacement parts 265

- replacing the battery
 - of the vehicle key 120
- Reset the trip recorder 105
- Retaining hooks 152
- Retrofitting
 - towing bracket 263
- Rev counter 102, 103
- Reverse gear (automatic gearbox) 177
- Rims
 - Changing a wheel 54
- Roll-back function
 - Windows 127
- Roof carrier 154
- Roof carrier system 154
- Roof load 156
 - technical data 156
- Roof luggage rack
 - attach the cross bars 155
- Roof rack 154
- RTA 224
- Running-in
 - new engine 184
- Running in
 - new brake pads 172
 - new tyres 291
- S**
- Safe
 - driving safe 62
- Safelock 119
 - see also Anti-theft security system 112
- Safety 62
 - child safety 79
 - child seats 79
 - deactivating the front passenger airbag 15
 - Safe driving 62
- Safety equipment 62
- Safety information
 - Knee airbags 16
- Safety instructions
 - head-protection airbags 76
 - side airbags 75
 - using child seats 17, 79
- Safety interlock for ignition key 165
- Safety notes
 - Seat belt tensioners 72
 - Using seat belts 69
- Saving fuel
 - inertia mode 182
- Saving tips (efficiency programme) 34
- Seat
 - electric seat 13
 - heating 144
- Seat belt position
 - for pregnant women 13
 - seat belts 13
- Seat belts 68
 - adjustment 13, 71
 - cleaning 272
 - control lamp 68
 - protective function 69
 - purpose 68, 73
 - Safety notes 69
 - unfastened 70
- Seat belt tensioners 14, 72
- SEAT Drive Profile 225
- Seat heating 144
- Seats
 - adjustment 143
 - rear seat backrest 146
- Selective catalytic reduction
 - see Exhaust purification system (diesel) 279
- Selective unlocking system 114
- Selector lever lock 178
- Selector lever (automatic gearbox)
 - malfunction 178
 - manual release 41
 - positions 177
- Service intervals 35
- Service notification: read 36
- Side airbags
 - description 16
 - safety instructions 75
- Side Assist PLUS 216
 - see Side Assist PLUS 216
- Signal lever 24
- Sitting position
 - driver 63
- Sliding panoramic sunroof 12
- Snow chains 56, 303
 - four-wheel drive 274
- Socket 148
- Spanner symbol 35
- Special characteristics
 - Area View system 249
 - high-pressure cleaning devices 258
 - tow-starting 86, 87
 - towing 86, 88
- Special Characteristics
 - Trailer mode 262
- Speed limiter 193, 194
 - control lamp 194
 - display message 194
 - operate 195
 - warning lamp 194
- Speed warning device 35
- Sport Mode 175
- Stabilisation of the towing vehicle and trailer .. 262
- Start-Stop 188

- Start-Stop system
 Driver messages 190
 lamps 188
 stopping and starting the engine 188
 Switching off and on 190
 The engine does not switch off 189
 The engine starts by itself 189
- Start-Stop System
 operation 188
- Starter button 167
- Starting the engine 165
- Starting the vehicle 23
- Steering
 electromechanical steering 273
 engaging the steering lock 166
- Steering wheel
 adjustment 14
 Gearshift paddles (automatic gearbox) 179
 setting 64
- Steering wheel controls 109
- Storage area
 front seat 147
 Storage compartment 148
 glove compartment 148
- Storage compartments 147
 glove compartment lighting 138
- Storing objects
 trailer 255
- Sun blinds
 anti-trap function (sunroof) 130
 sunroof 129
- Sun protection 138
- Sunroof 128
 anti-trap function 130
 closing 129
 opening 129
- operating malfunction 128
 sun blind 129
- Sun visors 138
- Switch
 hazard warning lights 135
- Switching off the engine
 with the key 166
- Switching off the lights 131
- Switching on the lights 131
- Switching the ignition on and off 23, 165
- System Easy Connect 108
- T**
- Tailboard for transporting long items 151
- tail light
 changing a bulb 93
- Taking care of your vehicle
 exterior 266
 interior 270
- Technical data
 Capacity 288
 roof load 156
 Vertical load on the coupling 255
- Technical specifications 301
- Tightening torques of wheel bolts 303
- Tiptronic (automatic gearbox) 177, 179
- Tire Mobility Set
 inflating a tyre 84
- Top speed 35
- Top Tether 19, 22
- Top Tether system 19, 22
- Top Tether System 22
- Tow-starting 58
- Tow-starting the engine 87
 special characteristics 86
- Tow hitch
 control lamp 258
 electrical unlocking 257
- Towing
 Blind spot detector (BSD) 225
 Special Characteristics 225
- Towing bracket 257
 also see Trailer 257
 control lamp 256
 electrical unlocking tow hitch 257
 fitting a bicycle rack 258
 malfunction 260
 retrofitting 263
- Towing the vehicle 57, 86, 87
 automatic gearbox 87
 driving tips 90
 four-wheel drive 87
 front towing eye 88
 manual gearbox 87
 rear towing eye 89
 special characteristics 86, 88
 tow bar 87
 towing not allowed 87
 with towing bracket 87
- Towline anchorages 57, 83
- Tow rope 257, 260
- Traffic Jam Assist 216
 malfunctions 218
 situations in which Traffic Jam Assist must be
 switched off 217
 switching off 217
 switching on 217
- Traffic sign detection system 228
 limited operation 230
 operation 229
 speed warning 230
 Trailer 230
 windscreens damage 228

- Traffic Sign Detection System 229
 Indication on display 229
- Traffic signs
 indication on display 229
- trailer
 mode 262
- Trailer 255
 adjusting the headlights 262
 anti-theft alarm 260
 anti-theft system 260
 connecting 259
 exterior mirrors 257
 hooking up 259
 loading 261
 malfunction 260
 maximum trailer weight 261
 mode 303
 Park Assist 244
 parking Aid 247
 power socket 259
 rear LED lights 257, 260
 Rear lights 257, 260
 retrofitting a towing bracket 263
 stabilisation of the towing vehicle and trailer 262
 technical requirements 256
 tow rope 257, 260
 trailer mode 262
 unlocking the electrical unlocking tow hitch 257
 vertical load on the coupling 261
 Vertical load on the coupling 255
- Trailer mode
 also see towing bracket 255
 see Driving with a trailer 255
- Trailer weights 303
- Transporting children 79
- Transporting items
 fastening rings 151
 Roof carrier 154
 roof carrier system 154
- Transporting objects
 loading the trailer 261
 net bag 152
 retaining hooks 152
 roof carrier system 156
 tailboard for transporting long items 151
 trailer mode 262
- Trim parts: cleaning 270
- Trims
 cleaning 268
- Turn signal convenience function 131
- Turn signal lever 131
- Tyre mobility set 53
 components 84
 sealing a tyre 84
- Tyre Mobility System
 see Anti-puncture kit 83
- Tyre monitoring system 295
- Tyre monitoring systems
 Tyre monitoring indicator 297
- Tyre pressure monitoring system 292
- Tyre pressures 303
- Tyre profile 293
- Tyre repair 83
- Tyre repair kit 83
 see also Anti-puncture kit 83
- Tyres 291
 Accessories 291
 changing 54
 dimensions 293
 new tyres 293
 repair kit 83
 tyre pressure 292
 useful life 292
 wear indicators 293
 with compulsory direction of rotation 56
 with directional tread pattern 291
- Tyre tread depth 293
- Tyre wear 293
- ## U
- Unfastening the seat belt 13, 71
- Unlocking and locking 9
 by remote control 114
 with Keyless Access 116
 with the central locking switch 115
- Upholstery: cleaning
 alcantara 272
 fabrics 270
- USB 111
- USB/AUX-IN Port 111
- ## V
- Vanity mirror 138
- Vehicle
 chassis number 301
 data label 301
 identification data 301
 identification number 301
 raising 55
 unlocking and locking the vehicle with Keyless
 Access 116
- Vehicle battery 50, 289
 assisted starting 278
 charge level 274
 charging 290
 connecting and disconnecting 289
 disconnect and connect 36
 power management 274

- replacing 290
 - winter conditions 289
 - Vehicle care
 - natural leather 271
 - windscreen wipers service position 60
 - Vehicle interior monitoring and anti-tow system
 - activation 122
 - Vehicle seats 68
 - Vehicle tool kit 54
 - Vehicle tools 83
 - Ventilation slits 149
 - Vertical load on the coupling 255
 - Vertical load on the trailer coupling
 - loading the trailer 261
- W**
- Warning and control lamps 38, 106
 - adaptive cruise control 199
 - Airbag system 77
 - applying the brake 199, 208
 - ASR 174
 - audible warning signal 106
 - Cruise control system (CCS) 193
 - electromechanical steering 273
 - engine management 187
 - engine pre-heating/fault system 187
 - ESC 174
 - for seat belts 68
 - gear change 183
 - instrument panel 38, 40
 - instrument panel display 39
 - Lane Assist 214
 - lights 131
 - refuelling 276
 - Start-Stop 188
 - tyre monitoring system 296
 - Warning lamps
 - AdBlue 279
 - speed limiter 194
 - Warning symbols
 - see Warning and control lamps 106
 - Warning triangle 135
 - Washing the vehicle 266
 - sensors 232
 - special characteristics 118
 - Weights 302
 - Wheel
 - changing 293
 - Wheel balance 292
 - Wheel bolts 303
 - anti-theft 54
 - caps 54
 - loosening 55
 - tightening torque 295
 - Wheel cover
 - removing 54
 - Wheels 291, 303
 - central wheel trim 54
 - chains 303
 - changing 54, 56
 - cleaning 269
 - new wheels 293
 - snow chains 56
 - temporary spare wheel 298
 - Wheel spanner 83
 - Windows
 - electric 12
 - Electric 126
 - removing ice 269
 - Window wiper 139
 - Window wiper blade 25
 - windscreen and rear window wiper blades
 - changing 61
 - cleaning 61
 - Windscreen and rear window wiper blades 85
 - Windscreen washer 50, 139
 - Windscreen washer water
 - Capacity 288
 - checking 288
 - Topping up 288
 - Windscreen wiper 139
 - Heated windscreen washer jets 139
 - window wiper lever 139
 - Windscreen wiper and rear window wiper systems
 - service position 60
 - Windscreen wipers 25
 - functions 139
 - headlight washer system 139
 - Lifting the wiper blade 60
 - rain sensor 140
 - replacing the wiper blades 60
 - service position 60
 - special characteristics 139
 - Winter conditions
 - battery 289
 - defrosting the windows 269
 - diesel 278
 - snow chains 56
 - Taking care of your vehicle 266
 - tyres 299
 - Winter driving
 - sunroof 128
 - Winter operation
 - headlight washers 140
 - Heated windscreen washer jets 139
 - Salt on the roads 140
 - Winter tyres 299
 - four-wheel drive 274

X

XDS 173


SEAT S.A. is permanently concerned about continuous development of its types and models. For this reason we ask you to understand, that at any given time, changes regarding shape, equipment and technique may take place on the car delivered. For this reason no right at all may derive based on the data, drawings and descriptions in this current handbook.

All texts, illustrations and standards in this handbook are based on the status of information at the time of printing. Except for error or omission, the information included in the current handbook is valid as of the date of closing print.

Re-printing, copying or translating, whether total or partial is not allowed unless SEAT allows it in written form.

SEAT reserves all rights in accordance with the "Copyright" Act.

All rights on changes are reserved.

 This paper has been manufactured using bleached non-chlorine cellulose.

© SEAT S.A. - Reprint: 15.05.16

Inglés 575012720BB (05.16)



575012720BB



SEAT recommends
SEAT **GENUINE OIL**



SEAT recommends
Castrol EDGE Professional