



OWNER'S MANUAL

Ibiza



About this manual

This manual contains a description of the **equipment** supplied with the vehicle at the time this manual was published. Some of the units described herein will not be available until a later date or are only available in certain markets.

Because this is a general manual for the IBIZA, some of the equipment and functions that are described in this manual are not included in all types or variants of the model; they may vary or be modified depending on the technical requirements and on the market; this is in no way deceptive advertising.

The **illustrations** are intended as a general guide and may vary from the equipment fitted in your vehicle in some details.

The **steering indications** (left, right, forward, reverse) appearing in this manual refer to the normal driving movements of the vehicle except when otherwise indicated.

The **audiovisual material** only is intended to help users to understand certain car functionalities better. It does not replace the instruction manual. Please use the instruction manual to obtain more comprehensive information and indications.

✱ The **equipment marked with an asterisk*** is fitted as standard only in certain versions, and is only supplied as optional extras for some versions, or are only offered in certain countries.

® All **registered marks** are indicated with ®. Although the copyright symbol does not appear, it is a copyrighted mark.

» The section is continued on the following page.



Important warnings on a given page



Detailed contents on a given page



General information on a given page



Emergency information on a given page



WARNING

Texts preceded by this symbol contain information on safety. They warn you about possible dangers of accident or injury.



CAUTION

Texts with this symbol draw your attention to potential sources of damage to your vehicle.



For the sake of the environment

Texts preceded by this symbol contain relevant information concerning environmental protection.



Note

Texts preceded by this symbol contain additional information.

This manual is divided into six large parts, which are:

1. The essentials
2. Safety
3. Emergencies
4. Operation
5. Tips
6. Technical data

At the end of this manual, there is a detailed alphabetical index that will help you quickly find the information you require.

Foreword

This Instruction Manual and its corresponding supplements should be read carefully to familiarise yourself with your vehicle.

Besides the regular care and maintenance of the vehicle, its correct handling will help preserve its value.

For safety reasons, always note the information concerning accessories, modifications and part replacements.

If selling the vehicle, give all of the on-board documentation to the new owner, as it should be kept with the vehicle.

You can access the information in this manual using:

- Thematic table of contents that follows the manual's general chapter structure.
- Visual table of contents that uses graphics to indicate the pages containing "essential" information, which is detailed in the corresponding chapters.
- Alphabetical index with many terms and synonyms to help you find information.

WARNING

Read and always observe safety information concerning the passenger's front airbag »» page 92, Important information regarding the front passenger's airbag.

Thank you for trusting in us.

We wish you safe and enjoyable motoring.

SEAT, S.A.

Related videos



The essentials: Opening and closing »» page 15

www.seat.com/youtube-af/ibiza/essentials-locking



The essentials: Engine bonnet »» page 17

www.seat.com/youtube-af/ibiza/essentials-bonnet



The essentials: Air conditioner »» page 51

www.seat.com/youtube-af/ibiza/essentials-aircond



The essentials: Vehicle interior »» page 19, »» page 21,
»» page 23

www.seat.com/youtube-af/ibiza/essentials-insidecar



The essentials: Wheels »» page 63, »» page 65

www.seat.com/youtube-af/ibiza/essentials-wheels



The essentials: Dashboard »» page 31, »» page 45,
»» page 47

www.seat.com/youtube-af/ibiza/essentials-dashboard



Convenience: Kessy keyless access and starting system, Full LED (+ Vision Pack): Full LED + Welcome light + LED daytime running lights + Lights sensor + LED interior lighting.

www.seat.com/youtube-af/ibiza/comfort

»» page 135
»» page 148
»» page 150
»» page 204



Technology: SEAT Navi System Plus 8" + Full Link / + Wireless charger in centre console + / Kessy keyless access and starting system.

www.seat.com/youtube-af/ibiza/technology

»» page 129
»» page 135
»» Booklet Navigation system



Safety: Adaptive cruise control + city safety assist with pedestrian monitoring, drowsiness detection, hill-start assist system; includes on-board computer and rear view camera.

www.seat.com/youtube-af/safety

»» page 189
»» page 216
»» page 227
»» page 234

Frequently Asked Questions

Before driving

How do you adjust the seat? » page 19

How do you adjust the steering wheel? » page 20

How do you adjust the exterior mirrors? » page 20

How do you turn on the exterior lights? » page 31

How does the automatic gearbox selector lever work? » page 50

How do you refuel? » page 57

How do you activate the windscreen wipers and windscreen washer system? » page 33

Emergency situations

A warning lamp lights up or flashes. What does this mean? » page 47

Where are the first-aid kit and the warning triangle in the vehicle? » page 97

How do you open the bonnet? » page 17

How do you perform a jump start? » page 71

Where is the vehicle tool kit located? » page 65

How do you repair a tyre with the anti-puncture kit? » page 64

How do you change a wheel? » page 65

How do you change a fuse? » page 62

How do you change a light? » page 63

How do you tow a vehicle? » page 70

Useful tips

How do you set the time? » page 118

When should the vehicle inspection should be performed? » page 43

What functions do the buttons/thumbwheels on the steering wheel perform? » page 124

How do you remove the luggage compartment cover? » page 163

How do you drive in an economical and environmentally-friendly way? » page 200

How do you check and top up the engine oil? » page 58

How do you check and top up the engine coolant? » page 59

How do you top up the windscreen washer fluid? » page 60

How do you check and top up the brake fluid? » page 60

How do you check and adjust tyre pressure values? » page 275

Vehicle washing tips » page 249

Functions of interest

Easy Connect, CAR menu » page 34

How does the START-STOP system work? » page 204

What parking assistants are available? » page 228

How does the rear assist work? » page 234

How does the adaptive cruise control work? » page 216

How can the SEAT driving mode be adjusted? » page 225

How does tyre pressure monitoring work? » page 278

How do you open the vehicle without a key (Keyless Access)? » page 135

Interior lighting and ambient light » page 150

Table of Contents

The essentials	7	How to jump start	71	Operation	115
Exterior view	7	Changing the windscreen wiper blades	73	Controls and displays	115
Exterior view	8	Safety	75	General instrument panel	114
Driver-side general instrument panel (left-hand drive)	9	Safe driving	75	Instruments and warning/control lamps	117
Driver-side general instrument panel (right-hand drive)	10	Safety first!	75	Instruments	117
Centre console	11	Advice about driving	75	Warning and control lamps	122
Passenger-side general instrument panel (left-hand drive)	12	Correct position of the vehicle occupants	76	Introduction to the Easy Connect system*	123
Passenger-side general instrument panel (right-hand drive)	13	Pedal area	80	System settings (CAR)*	123
Interior view	14	Seat belts	81	Communications and multimedia	124
How it works	15	Why wear a seat belt	81	Steering wheel controls*	124
Opening and closing	15	How to properly adjust your seatbelt	84	Multimedia	129
Before driving	19	Seat belt tensioners*	85	Opening and closing	130
Airbags	21	Airbag system	86	Keys	130
Child seats	23	Brief introduction	86	Central locking system	132
Starting the vehicle	31	Airbag safety instructions	88	Anti-theft alarm*	138
Lights and visibility	31	Deactivating airbags	90	Rear lid	141
Easy Connect	34	Transporting children safely	92	Controls for the windows	141
Driver information System	37	Child safety	92	Sunroof*	144
Status display	40	Child seats	93	Lights and visibility	146
Cruise control	45	Event Data Recorder	96	Lights	146
Warning lamps	47	Description and operation	96	Interior lights	150
Gearbox lever	50	Emergencies	97	Visibility	151
Air conditioning	51	Self-help	97	Windscreen wiper and rear window wiper systems	152
Fluid Level control	57	Emergency equipment	97	Rear view mirrors	152
Emergencies	62	Tyre repair	98	Seats and head restraints	154
Fuses	62	Changing the windscreen wiper blades	100	Adjusting the seat and head restraints	154
Bulbs	63	Towing or tow-starting	100	Seat functions	156
Action in the event of a puncture	63	Fuses and bulbs	104	Transport and practical equipment	158
Changing a wheel	65	Fuses	104	Practical equipment	158
Snow chains	70	Changing bulbs	106	Luggage compartment	160
Emergency towing of the vehicle	70	Halogen headlights	107	Roof carrier*	164
		Changing the fog light bulbs	109	Air conditioning	166
		Changing the tail light bulbs	109	Heating, ventilation and cooling	166
		Changing the interior bulbs	111	Heating and fresh air	169
				Manual air conditioning*	171
				Climatronic*	173

Table of Contents

Driving	175	Checking and refilling levels	257
Starting and stopping the engine	175	Refuelling	257
Braking and parking	181	Fuel	258
Braking and stability systems	183	AdBlue®	261
Manual gearbox	189	Working in the engine compartment	263
Automatic gearbox/DSG automatic gear- box*	190	Engine oil	266
Gear-change indicator	197	Cooling system	269
Steering	197	Brake fluid	271
Run-in and economical driving	199	Windscreen washer reservoir	272
Engine management and emission control sys- tem	202	Vehicle battery	272
Driving tips	203	Wheels	274
Driver assistance systems	204	Wheels and tyres	274
Start-Stop System*	204	Spare wheel (temporary spare wheel)*	279
Cruise control system (CCS)*	207	Winter service	280
Speed limiter	209	Technical data	281
Emergency brake assist system (Front As- sist)*	212	Technical specifications	281
Adaptive Cruise Control (ACC)*	216	Important information	281
SEAT Drive Profile*	225	Fuel consumption data	282
Fatigue detection (break recommendation)* ..	227	Trailer mode	282
Parking aid (Park Pilot)	228	Wheels	283
Rear Assist "Rear View Camera"*	234	Engine data	284
Towing bracket device	237	Dimensions	295
Towing bracket device*	237	Index	297
Trailer towing	242		
Advice	247		
Care and maintenance	247		
Accessories and modifications to the vehi- cle	247		
Care and cleaningTaking care of your vehi- cle	248		
Care of the vehicle exterior	249		
Caring for the vehicle interior	254		

Exterior view

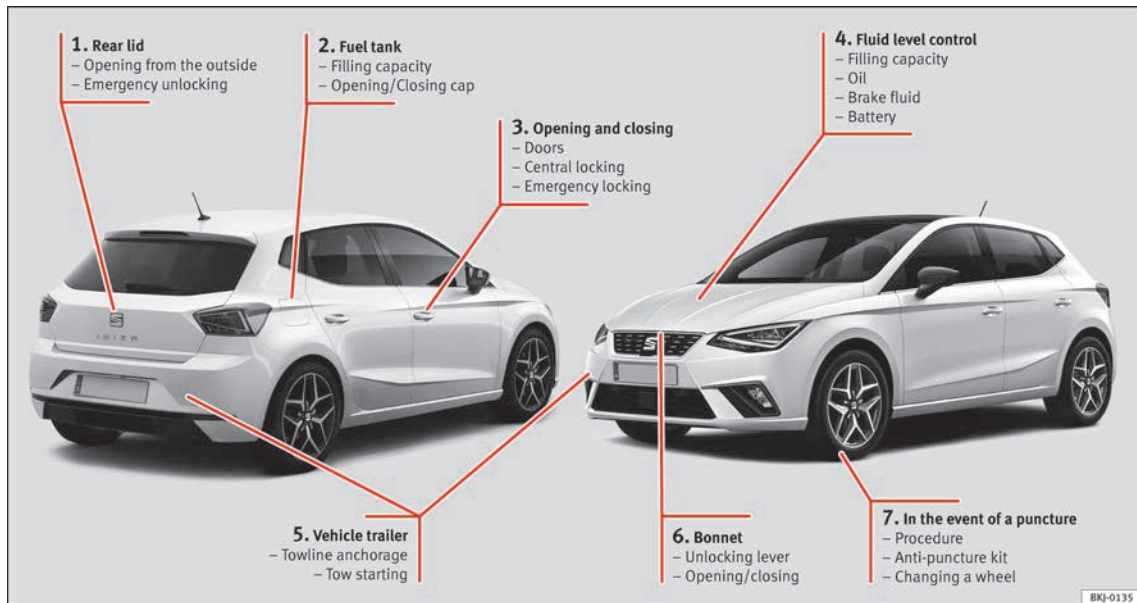

① » page 16

② » page 57

③ » page 15

④ » page 57

⑤ » page 70

⑥ » page 17

⑦ » page 63

Exterior view

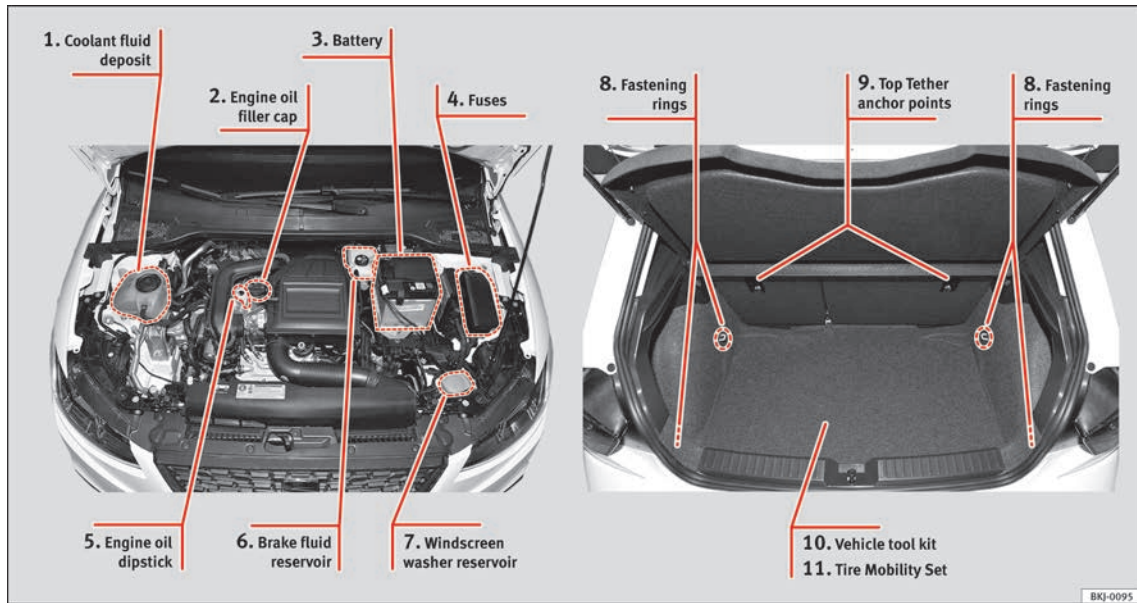

① » page 59

② » page 58

③ » page 60

④ » page 62

⑤ » page 58

⑥ » page 60

⑦ » page 60

⑧ »  page 162

⑨ » page 30

⑩ » page 65

⑪ » page 64

Driver-side general instrument panel (left-hand drive)

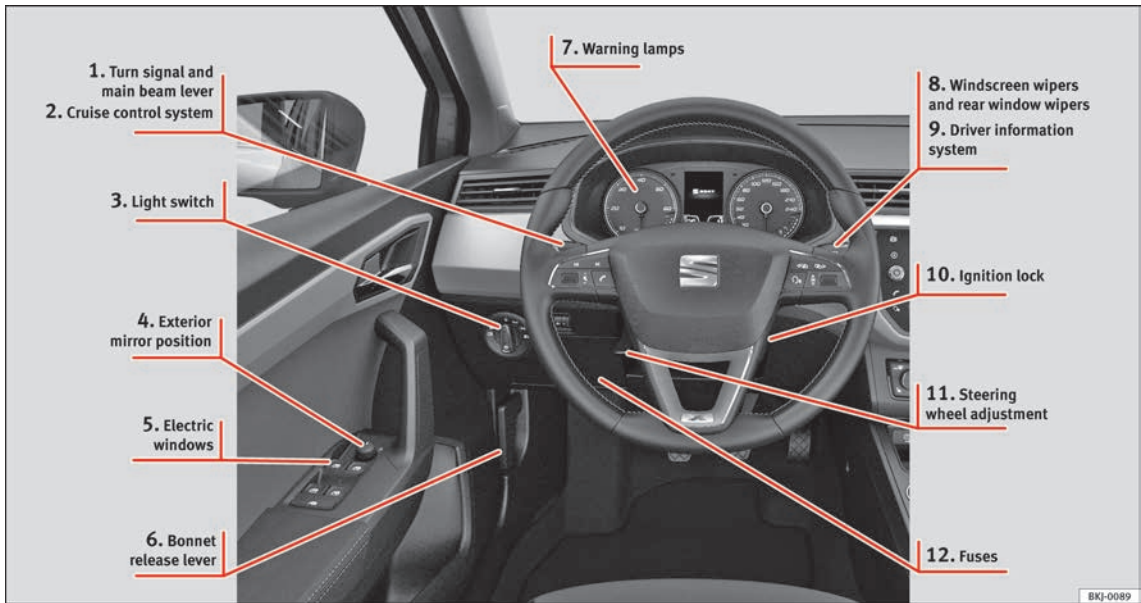

- ① » page 32
- ② » page 45
- ③ » page 31
- ④ » page 20

- ⑤ » page 18
- ⑥ » page 17
- ⑦ » page 47
- ⑧ » page 33

- ⑨ » page 37
- ⑩ » page 31
- ⑪ » page 20
- ⑫ » page 62

Driver-side general instrument panel (right-hand drive)

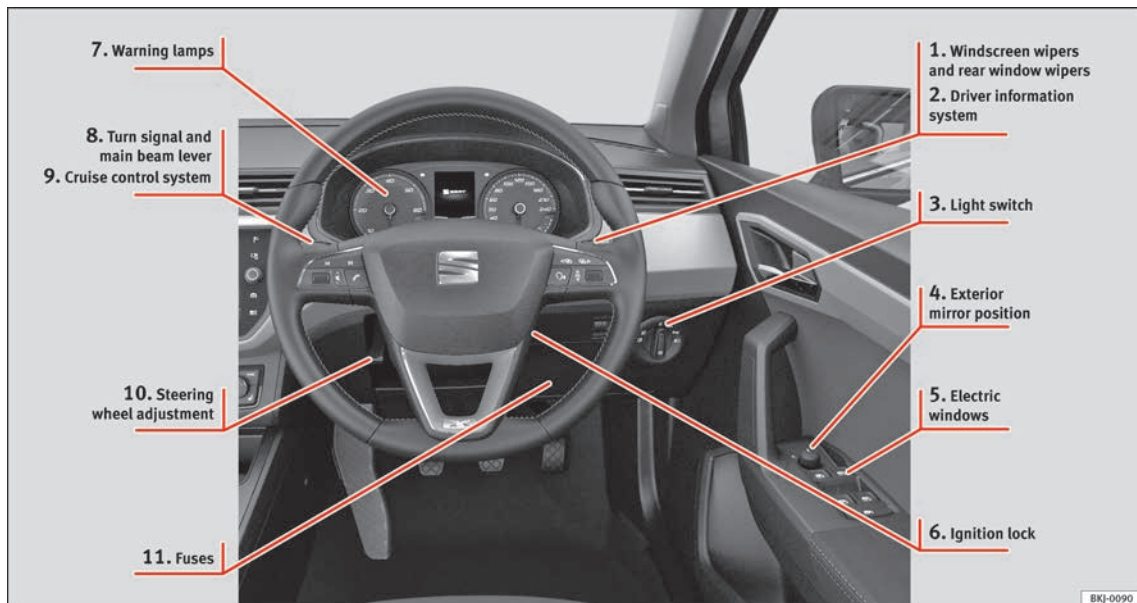

① » page 33

② » page 37

③ » page 31

④ » page 20

⑤ » page 18

⑥ » page 31

⑦ » page 47

⑧ » page 32

⑨ » page 45

⑩ » page 20

⑪ » page 62

Centre console

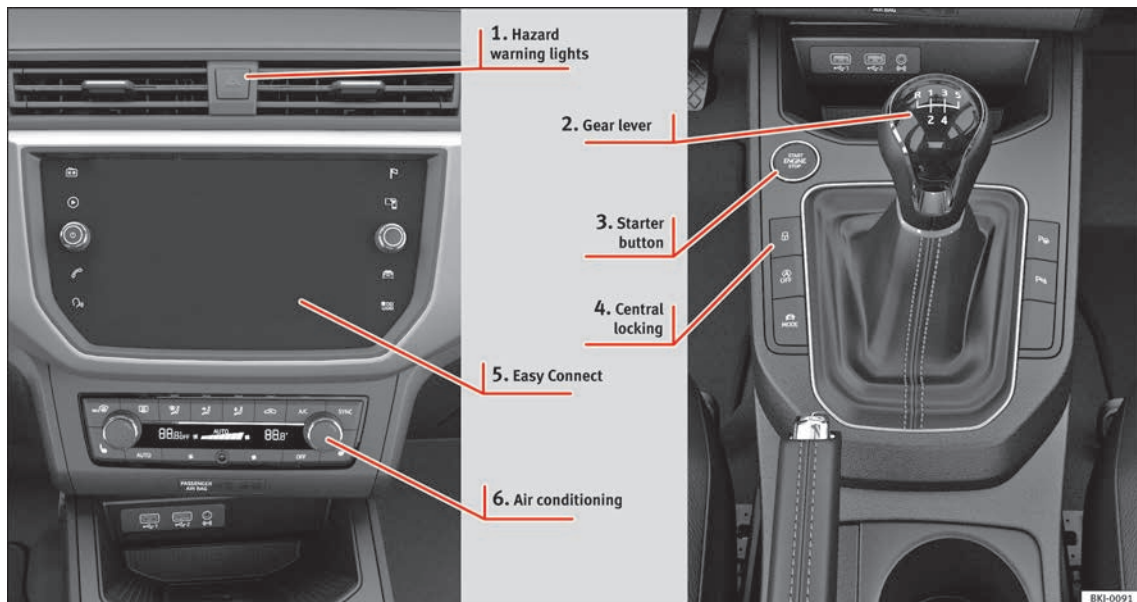

① » page 32

② » page 50

③ »  page 178

④ » page 15

⑤ » page 34

⑥ » page 51, » page 54

The layout in right-hand drive vehicles is symmetrical.

Passenger-side general instrument panel (left-hand drive)



- ① »» page 21
- ② »» page 18
- ③ »» 📖 page 158

Passenger-side general instrument panel (right-hand drive)



- ① »» page 21
- ② »» page 18
- ③ »» page 17
- ④ »»  page 158

Interior view

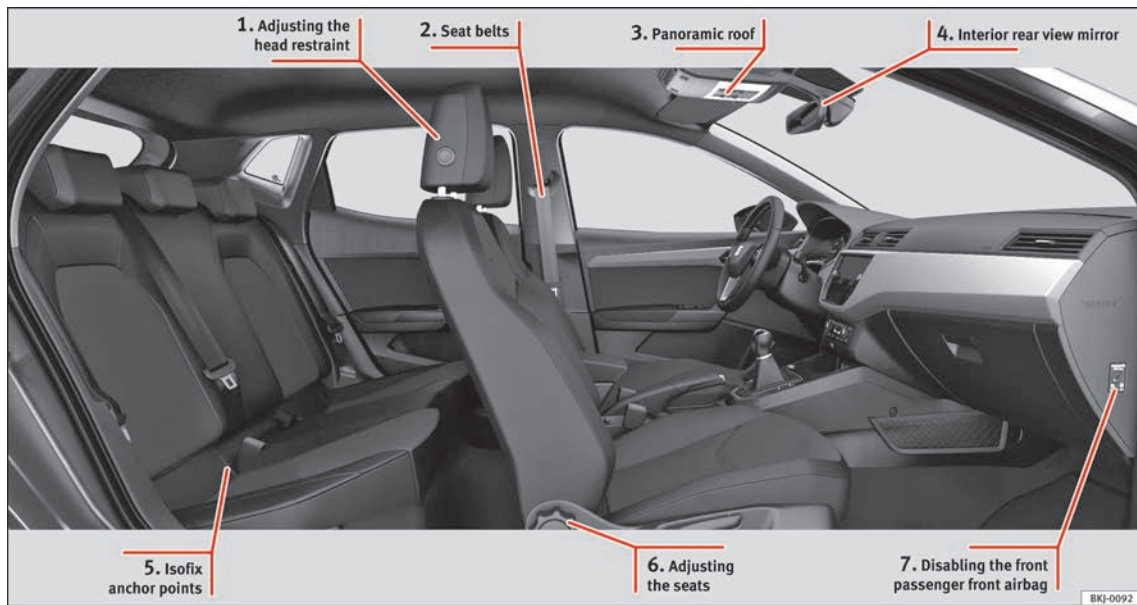

① » page 19

② » page 19

③ » page 18

④ »  page 152

⑤ » page 27

⑥ » page 19

⑦ » page 22

How it works

Opening and closing

Related video



BKJ-0110

Fig. 1 Opening and closing

Doors



BSF-0328



Fig. 2 Remote control key: buttons.





BKJ-0007

Fig. 3 Centre console: Central lock buttons.

Locking and unlocking the vehicle using the key

- Locking: press the  **Fig. 2** button.
- Unlocking: press the  **Fig. 2** button.
- Unlocking the rear lid: press the  button **Fig. 2** until all the turn signals on the vehicle briefly light up.

Locking and unlocking with the central locking switch

- Locking: press the  **Fig. 3** button. The  symbol lights up yellow to indicate that it is activated. None of the doors can be opened from the outside. The doors can be opened from the inside by pulling the inside door handle.
- Unlocking: Press the  button again **Fig. 3**. The symbol reverts to its initial colour.



»  in Description on page 132



» page 132

Unlocking or locking of driver door

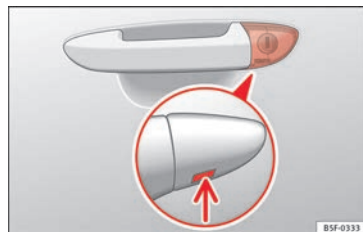

BSF-0333

Fig. 4 Driver door lever: hidden lock cylinder.

If the central locking system should fail to operate, the driver door can still be locked and unlocked by turning the key in the lock.

As a general rule, when the driver door is locked manually all other doors are locked. When it is unlocked manually, only the driver door opens. Please observe the instructions relating to the anti-theft alarm system **»  page 138.**

- Unfold the vehicle key blade **»  page 130.**



- Insert the key shaft into the lower opening in the cover on the driver door handle »» Fig. 4 (arrow) then remove the cover upwards.
- Insert the key blade into the lock cylinder to unlock or lock the vehicle.

Special Characteristics

- The anti-theft alarm will remain active when vehicles are unlocked. However, the alarm will not be triggered »»  page 138.
- After the driver door is opened, you have 15 seconds to switch on the ignition. Once this time has elapsed, the alarm is triggered.
- Switch the ignition on. The electronic immobilizer recognises a valid vehicle key and deactivates the anti-theft alarm system.

Note

The anti-theft alarm is not activated when the vehicle is locked manually using the key shaft»»  page 138.

Emergency locking of doors without door cylinder



Fig. 5 Locking the door manually.

If the central locking system should fail to work at any time, doors with no lock cylinder will have to be locked separately.

A mechanical locking device (only visible when the door is open) is provided on the front passenger door.

- Pull the cap out of the opening.
- Insert the key in the inside slot and turn it to the right as far as it will go (if the door is on the right side) or to the left (if the door is on the left side).

Once the door has been closed it can no longer be opened from the outside. Pull the interior door handle once to unlock and open the door.

Rear lid





Fig. 6 Rear lid: opening from the outside.

The rear lid opening system operates electrically. It is activated by using the handle on the boot lid.

This system may or may not be operative, depending on the situation of the vehicle.

If the rear lid is locked then it cannot be opened, however if it is unlocked then the opening system is operative and the rear lid may be opened.

To lock/unlock, press the  button or the  button »» Fig. 2 on the remote control key.

A warning appears on the instrument panel display if the rear lid is open or not properly closed.* An audible warning is also given if the boot lid is opened while the vehicle is moving faster than 6 km/h (4 mph)*.

- Opening the rear lid: pull on the release lever and lift it up »» Fig. 6. The rear lid opens automatically.
- Closing the rear lid: Hold it by one of the handles on the interior lining and close it by pushing gently.



»» ⚠ in Opening and closing on page 141

SOS

»» page 17

Unlocking the rear lid manually

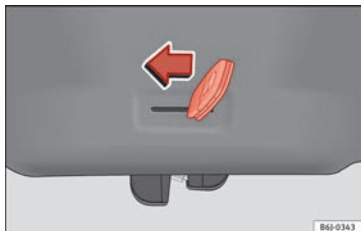

Fig. 7 Unlocking the rear lid manually.

This allows the vehicle to be opened if the central locking does not work (for example, if the battery is flat).

There is a groove in the luggage compartment allowing access to the emergency opening mechanism.

Opening the rear lid from inside the luggage compartment

- Insert the key in the groove and unlock the locking system, turning the key from right to left, as shown by the arrow »» Fig. 7.

Related video



BKJ-0111

Fig. 8 Bonnet

Bonnet

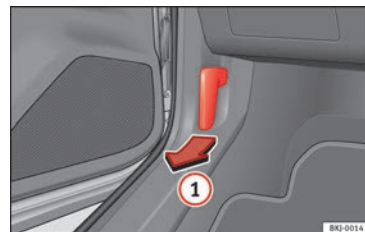

Fig. 9 Release lever in the driver's footwell area.



Fig. 10 Lever under the bonnet.

Before opening the bonnet, make sure that the windscreen wiper arms are in place against the windscreen.

- Open the door and pull the lever under the dashboard »» Fig. 9 ①.



- To lift the bonnet, press towards the left on the lever located under the bonnet, in the centre »» Fig. 10 ②. The arrester hooks are released.
- Release the bonnet stay and secure it in the fixture designed for this in the bonnet.



»» ⚠ in Safety notes for work in the engine compartment on page 263



»» page 263

Controls for the windows*

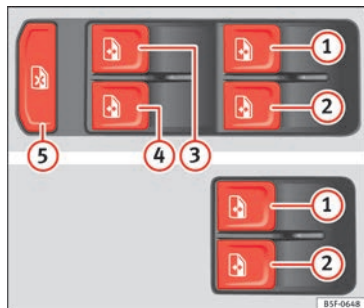

Fig. 11 Detail of the driver door: controls for the windows.

- Opening the window: Press the  button.

- Closing the window: Pull the  button.

Buttons on the driver door

- ① Window on the front left door
- ② Window on the front right door
- ③ Window on the rear left door (only vehicles with rear electric windows)
- ④ Window on the rear right door (only vehicles with rear electric windows)
- ⑤ Safety switch for deactivating the electric window buttons on the rear doors (only vehicles with rear electric windows)



»» ⚠ in Opening and closing of the electric windows* on page 142



»» page 141

Sliding sunroof*

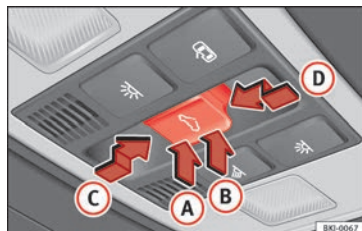

Fig. 12 On the interior roof lining: sunroof button.

- Opening: press button **C** backwards.
- Closing: press button **D** forwards.
- To tilt open: press the rear part of button **B**.
- Lowering: press the front part of button **A**.



»» ⚠ in Introduction on page 144



»» page 144

Before driving

Related video



BKJ-0113

Fig. 13 Vehicle interior

Manually adjusting the front seats

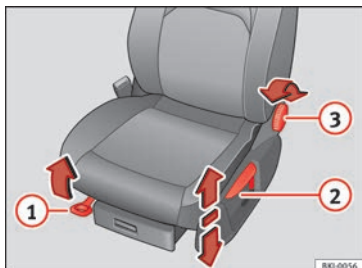

BKJ-0056

Fig. 14 Front seats: manual seat adjustment.

- ① Forward/back: pull the lever and move the seat forwards or backwards.
- ② Raising/lowering: pull/push the lever.
- ③ Tilting the backrest: turn the hand wheel.



» » ⚠ in Adjusting the front seats on page 154

Adjusting the head restraints

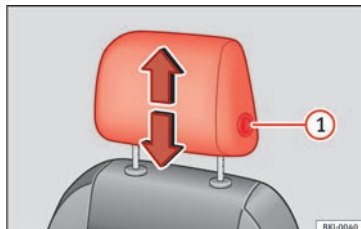

BKJ-0060

Fig. 15 Front seat: adjustment of the head restraint.

- To raise or lower the head restraint, press the side button ① and move it upwards or downwards until it engages in the desired position.



» » ⚠ in Adjusting the front head restraints on page 155



» » page 79, » » page 155

Adjustment of the seat belt

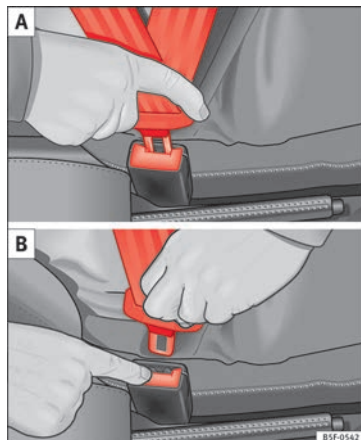

BSF-0542

Fig. 16 Positioning and removing the seat belt buckle.



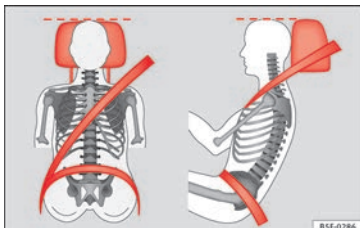

Fig. 17 Correct seat belt and head restraint positions, viewed from front and the side.

To adjust the seat belt around your shoulders, adjust the height of the seats.

The shoulder part of the seat belt should be well centred over it, never over the neck. The seat belt lies flat and fits comfortably on the upper part of the body.

The lap part of the seat belt lies across the pelvis, never across the stomach. The seat belt lies flat and fits comfortably on the pelvis.

! » page 82

» page 84

Seat belt tensioners

During a collision, the seat belts on the front seats are retracted automatically.

The tensioner can be triggered only once.

! » in Maintenance and disposal of belt tensioners on page 86

» page 85

Adjusting the exterior mirrors

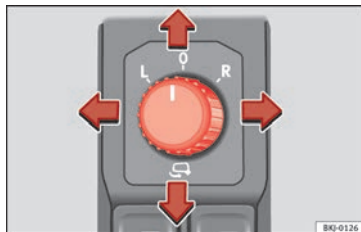

Fig. 18 Detail of the driver door: control for the exterior mirror.

Adjusting the exterior mirrors: Turn the knob to the corresponding position:

L/R Turning the knob to the desired position, adjust the mirrors on the driver

side (L, left) and the passenger side (R, right) to the direction desired.

↪ Folding in mirrors.

! » in Electric exterior mirrors* on page 154

» page 153

Adjusting the steering wheel

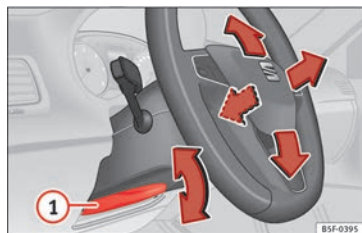

Fig. 19 Lever in the lower left side of the steering column.

• Adjusting the position of the steering wheel: Pull the » **Fig. 19** ① lever down, move the steering wheel to the desired position and lift the lever back up until it locks.

! » in Adjusting the steering wheel position on page 77

Airbags

Related video



BKJ-0113

Fig. 20 Vehicle interior

Front airbags

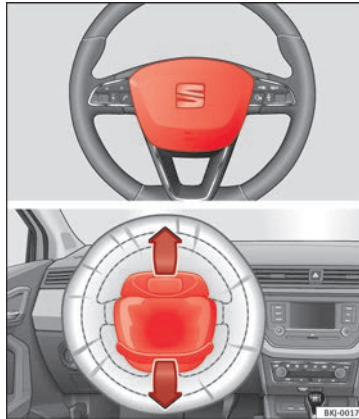

Fig. 21 Driver airbag located in steering wheel.

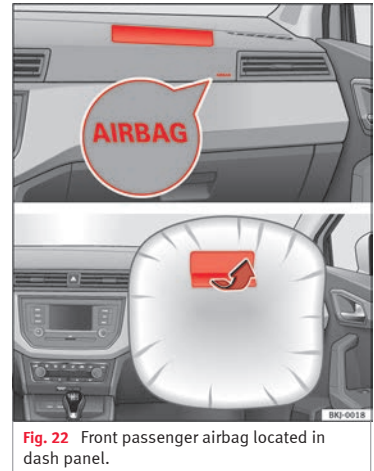

Fig. 22 Front passenger airbag located in dash panel.

The front airbag for the driver is located in the steering wheel »» Fig. 21 and the airbag for the front passenger is located in the dash panel »» Fig. 22. Airbags are identified by the word “AIRBAG”.

When the driver and front passenger airbags are deployed, the covers remain attached to the steering wheel and dashboard, respectively »» Fig. 21 »» Fig. 22.

In conjunction with the seat belts, the front airbag system gives the driver and the front passenger additional protection for the head »»

and chest in the event of a severe frontal collision.

The special design of the airbag allows the controlled escape of the propellant gas when an occupant puts pressure on the bag. Thus, the head and chest are surrounded and protected by the airbag. After the collision, the airbag deflates sufficiently to allow visibility.



» page 88

Deactivating the front passenger front airbag*



Fig. 23 Front passenger front airbag switch.



Fig. 24 Centre side of dash panel: control lamp for deactivated front passenger airbag in centre console.

To deactivate the front passenger front airbag:

- Switch the ignition off.
- Switch the ignition off.
- Open the door on the front passenger side.
- Insert the key into the slot of the switch for deactivating the front passenger airbag » Fig. 23. About 3/4 of the key should enter; this is as far as it will go.
- Turn the key gently to the **OFF** position. If you have difficulty, ensure that you have inserted the key as far as it will go.
- Close the front passenger door.
- Check, with the ignition switched on, that the **OFF** control lamp remains lit where it says **PASSENGER AIR BAG OFF** in the centre of the dash panel » Fig. 24.



» in Activation and deactivation of front passenger airbag* on page 91



» page 90

Side airbags*

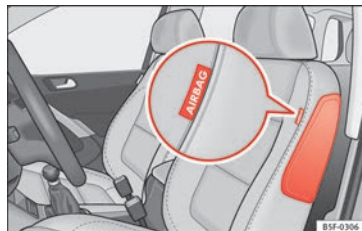

Fig. 25 Side airbag in driver's seat.

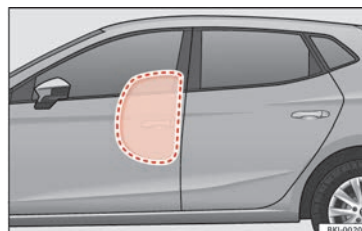

Fig. 26 Illustration of completely inflated side airbag on left side of vehicle.

The side airbags are located in the driver's seat and front passenger seat backrests »» **Fig. 25**. The locations are identified by the text "AIRBAG" in the upper region of the backrests.

In conjunction with the seat belts, the side airbag system provides additional protection for the upper body in the event of a severe side collision.

In a side collision, the side airbags reduce the risk of injury to passengers to the areas of the body facing the impact. In addition to their normal function of protecting the occupants in a collision, the front and rear outer seat belts also hold the passengers in the event of a side collision; this is how these airbags provide maximum protection.



»» ⚠ in Side airbags* on page 88

Head-protection airbags*



Fig. 27 Location and deployment area of the head-protection airbag.

There is a head airbag on each side of the interior above the doors »» **Fig. 27**. Airbags are identified by the word "AIRBAG".

The area framed in red is covered by the head-protection airbag when it is deployed »» **Fig. 27** (deployment area). Therefore, objects should never be placed or mounted in this area »» ⚠ in Head-protection airbags* on page 89.

In the event of a side collision the curtain airbag is triggered on the impact side of the vehicle.

The head-protection airbags reduce the risk of injury to passengers in the front and rear side seats facing the impact.



»» ⚠ in Head-protection airbags* on page 89

Child seats

Related video



BKJ-0113

Fig. 28 Vehicle interior

Important information regarding the front passenger's airbag





Fig. 29 Airbag stickers - version 1: on the passenger-side sun blind [A] and on the rear frame of the front passenger's door [B].



Fig. 30 Airbag stickers - version 2: on the passenger-side sun blind [A] and on the rear frame of the front passenger's door [B].

A sticker with important information about the passenger airbag is located on the pas-

senger's sun visor and/or on the passenger side door frame.

 »»  in Important information regarding the front passenger's airbag on page 92

 »» page 92

Securing child seats

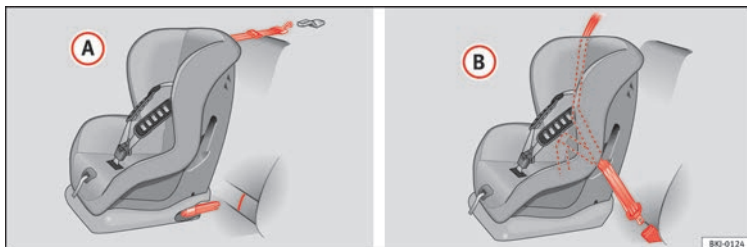

Fig. 31 On the rear seats: Possible installations for the child seat.

Figure » **Fig. 31 A** shows the basic child restraint system mounting using lower retaining rings and the upper retaining strap. Figure » **Fig. 31 B** shows the child restraint system mounting using the vehicle seat belt.

The seat belt may be used to secure **universal** type child seats to the vehicle seats marked with a **U** in the table below.

- *In a front passenger seat without height adjustment:* It is necessary to place the front passenger seat in its rearmost position¹⁾.
- *In a front passenger seat with height adjustment:* it is necessary to place the front

passenger seat in its rearmost and highest position¹⁾.

To correctly use a child seat in the back, the front backrest must be adjusted so that there is no contact with the child seat in the back in the case that it goes opposite to the direction of the car. In the case of front facing restraint systems, the front backrest must be adjusted so that there is no contact with the child's feet.

To adjust the passenger seat to accommodate a child's seat and get the seat belt in a

perfect position, adjust the passenger backrest as far forward as possible¹⁾.

If a semi-universal type chair is to be installed, in which the method of attachment to the car is through the seat belt and support bracket, it should never be installed in the central rear seat as the ground clearance is lower than in other places and the support bracket will not allow the seat to remain sufficiently stable.

The systems include the child restraint system mounting with an upper retaining strap (Top Tether) and lower anchoring points on the seat.

¹⁾ Compliance with current national legislation and the manufacturer's instructions is required when using or installing child seats.

The essentials

Weight group	Seating position			
	Front passenger seat ^{a)}		Rear side seat	Rear central seat ^{b)}
	airbag on	airbag off		
Group 0 to 10 kg	X	U ^{c)}	U	U
Group 0+ to 13 kg	X	U ^{c)}	U	U
Group I 9 to 18 kg	X	U ^{c)}	U	U
Group II 15 to 25 kg	X	UF ^{c)}	UF	UF
Group III 22 to 36 kg	X	UF ^{c)}	UF	UF

X: It is not compatible to install chairs in this configuration.

U: Suitable for universal restraint systems for use in this weight group.

UF: Acceptable for front-facing universal-category child restraint systems approved for this mass group.

- a) Compliance with current national legislation and the manufacturer's instructions is required when using or installing child seats.
- b) For semi-universal chairs where the securing system is the car safety belt and the support bracket, do not use them in the centre rear seat.
- c) Seats **without** height adjustment should be placed in their rearmost position. Seats **with** height adjustment should be placed in their rearmost and highest position.



» » in Safety instructions on page 93

Securing child seats with the ISOFIX/iSize and Top Tether system*



Fig. 32 ISOFIX/iSize securing rings.



Fig. 33 Position of the Top Tether rings on the back of the rear seat.

Child seats can be secured quickly, easily and safely on the rear outer seats with the “ISOFIX” and Top Tether* system.

Two “ISOFIX” retaining rings are fitted on each rear seat. In some vehicles, the rings are secured to the seat frame and, in others, they are secured to the rear floor. The “ISO-

FIX” rings are located between the rear seat backrest and the seat cushioning »» Fig. 32. The Top Tether* rings are located on the rear part of the backrests of the rear seats (behind the seat backrest or in the boot) »» Fig. 33.

To understand the compatibility of the “ISOFIX” systems in the vehicle, consult the table below.

The body weight permitted and information regarding sizes **A** to **F** is indicated on the label on child seats with “**universal**” or “**semi-universal**” certification.

Weight group	Size class	Electrical equip- ment	Vehicle Isofix positions			
			Front passenger seat		Rear side seat	Rear central seat
			airbag on	airbag off		
Baby carrier	F	ISO/L1	X	X	X	X
	G	ISO/L2	X	X	X	X
Group 0 to 10 kg	E	ISO/R1	X	X	IL	X

»»

The essentials

Weight group	Size class	Electrical equip- ment	Vehicle Isofix positions			
			Front passenger seat		Rear side seat	Rear central seat
			airbag on	airbag off		
Group 0+ to 13 kg	E	ISO/R1	X	X	IL	X
	D	ISO/R2	X	X	IL	X
	C	ISO/R3	X	X	IL	X
Group I 9 to 18 kg	D	ISO/R2	X	X	IL	X
	C	ISO/R3	X	X	IL	X
	B	ISO/F2	X	X	IUF/IL	X
	B1	ISO/F2X	X	X	IUF/IL	X
	A	ISO/F3	X	X	IUF/IL	X
Group II 15 to 25 kg	---	---			---	---
Group III 22 to 36 kg	---	---			---	---

IUF: Suitable for forward-facing ISOFIX universal child restraint systems approved for use in this mass group.

IL: It is suitable for certain ISOFIX child restraint systems (CRS) that can be for the specific vehicle, restricted or semi-universal categories. Take the child seat manufacturer's vehicle list into account.

X: ISOFIX position not suitable for ISOFIX child restraint systems for this weight group or size class.



» » in Safety instructions on page 93

Securing child seats with the “ISOFIX/i-Size” ISOFIX System



Fig. 34 ISOFIX/iSize securing rings.

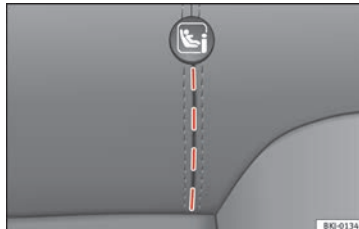

Fig. 35 Rear seat: cut-out grooves.

You are obliged to follow the seat manufacturer's instructions.

- Open the cut-out section behind the marked grooves to access the retaining rings » Fig. 35.
- Press the child seat onto the “ISOFIX/iSize” retaining rings until the child seat is heard to

engage securely. If the child seat is equipped with Top Tether* anchor points, secure it to the correspondent ring » Fig. 36. Observe the manufacturer's instructions.

- Pull on both sides of the child seat to ensure that it is properly anchored.

Child seats with the “ISOFIX” and Top Tether* attachment system are available from Technical Services.

	Vehicle i-Size positions			
	Front passenger seat		Rear side seat	Rear central seat
	airbag on	airbag off		
Child restraint system approved under ECE R129	X	X	i-U	X

i-U Valid position for front-facing and rear-facing child restraint systems approved under ECE R129.

X: Invalid position for child restraint systems approved under ECE R129.

Securing child seats with the Top Tether* retaining straps



Fig. 36 Position of the Top Tether rings on the back of the rear seat.

Child seats with the Top Tether system come with a strap for securing the seat to the vehicle anchor point, located at the back of the rear seat backrest and provide greater restraint.

The objective of this strap is to reduce forward movements of the child seat in a crash, to reduce the risk of injuries to the head from hitting the inside of the vehicle.

Using the Top Tether in rear-facing mounted seats

Currently, there are very few rear-facing child safety seats that have Top Tether. Please carefully read and follow the seat manufacturer instructions to learn the proper way to install the Top Tether strap.

Securing the Top Tether* to the anchorage point

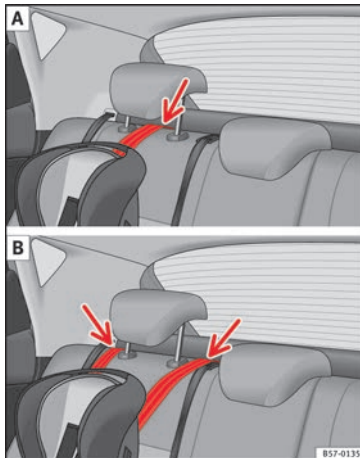

Fig. 37 Retainer strap: adjustment and assembly according to the Top Tether belt.

Securing the retainer strap

- Follow the manufacturer's instructions to deploy the child seat Top Tether retainer strap.
- Place the belt under the head restraint of the back seat »» **Fig. 37** (depending on the in-

structions of the chair itself, lift or remove the head restraint if necessary).

- Slide the strap and secure it properly with the anchorage of the backrest »» **Fig. 36**.
- Firmly tighten the strap following the manufacturer's instructions.

Releasing the retaining strap

- Loosen the strap following the manufacturer's instructions.
- Push the lock and release it from the anchoring support.



»» ⚠ in Safety instructions on page 93

Starting the vehicle

Ignition lock

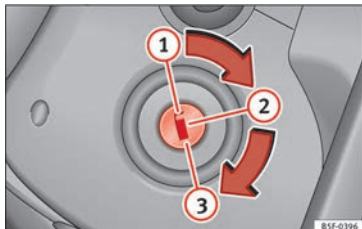

Fig. 38 Ignition key positions.

Switch ignition on: Place the key in the ignition and start the engine.

Locking and unlocking the steering wheel

- Engaging the steering wheel lock: Remove the key from the ignition and turn the wheel until it locks. In vehicles with an automatic gearbox, the gear lever must be in the **P** position in order to remove the key. If necessary, press the locking key on the selector lever and release it again.
- Unlocking the steering wheel: Put the key into the ignition and turn it at the same time as the steering wheel in the direction indicated by the arrow. If it is not possible to turn the steering wheel, it may be because it is locked.

Turning on/switching off the ignition, glow plugs reheating

- Switch ignition on: Turn the key to the ② position.
- Switch ignition off. Turn the key to the ① position.
- Diesel vehicles ∅: The glow plugs reheat when the ignition is switched on.

Starting the engine

- Manual gearbox: press the clutch pedal all the way down and move the gearbox lever into neutral.
- Automatic gearbox: Press the brake pedal and move the selector lever to the **P** position or into **N**.
- Turn the key to the ③ position. The key automatically returns to the ② position. Do not press the accelerator.

Start-Stop System*

When you stop and release the clutch pedal, the Start-Stop system* turns off the engine. The ignition remains switched on.



» » in Ignition key positions on page 175



» » page 175

Lights and visibility

Related video



BKJ-0115

Fig. 39 Dash panel

Light switch



B57-0006

Fig. 40 Dash panel: light control.

- Turn the switch to the required position » » Fig. 40.



Symbol	Ignition switched off	Ignition is switched on
0	Fog lights, dipped beam and side lights off.	Light off or daytime driving light on.
AUTO	The "Coming home" and "Leaving home" guide lights may be switched on.	Automatic control of dipped beam and daytime running light.
☞☜	Side light on.	Daylight running lights switched on.
☞☜	Dipped beam headlight off	Dipped beam switched on.

☞☜ Front fog lights: move the switch to the first position, from positions **AUTO**, ☞☜ or ☞☜.

☞☜ Rear fog light: move the switch completely from positions **AUTO**, ☞☜ or ☞☜.

Switching off fog lights: Push the switch or turn it to the 0 position.



» page 146

Turn signal and main beam lever

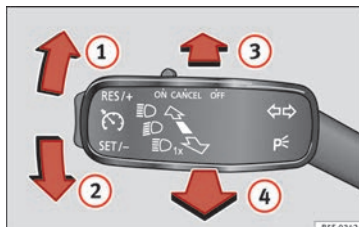

Fig. 41 Turn signal and main beam lever.

More the lever to the required position:

- 1 Right turn signal: Right-hand parking light (ignition switched off).
- 2 Left turn signal: Left-hand parking light (ignition switched off).
- 3 Main beam switched on: control lamp ☞☜ lit up on the instrument panel.
- 4 Headlight flasher: lit up when the lever is pushed. Control lamp ☞☜ lit up.

Lever all the way down to switch it off.



» ⚠ in Turn signal and main beam lever on page 148



» page 147

Hazard warning lights



Fig. 42 Dash panel: switch for hazard warning lights.

Switched on, for example:

- When approaching a traffic jam
- In an emergency
- The vehicle has broken down
- When towing or being towed



» ⚠ in Hazard warning lights ⚠ on page 150



» page 150

Interior lights

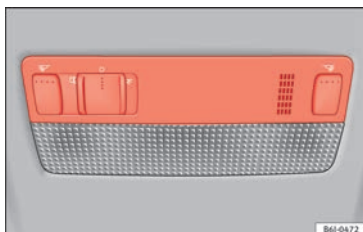

Fig. 43 Detail of headliner: front interior lighting.

Knob	Function
0	Switches interior lights off.
	Switches interior lights on.
	Switches door contact control on (central position). The interior lights come on automatically when the vehicle is unlocked, a door is opened or the key is removed from the ignition. The lights go off a few seconds after all the doors are closed, the vehicle is locked or the ignition is switched on.

Knob	Function
	Turning the reading light on and off

The light controls may vary depending on the vehicle version.

» page 150

Windscreen wipers and window wiper blade

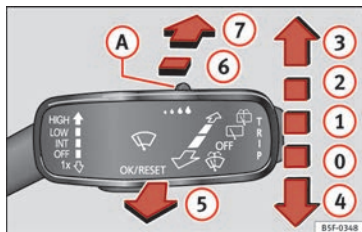

Fig. 44 Operating the windscreen wiper and rear wiper.

More the lever to the required position:	
0	OFF Windscreen wiper off.
1	Windscreen wipers interval wipe. Using the control adjust the interval (vehicles without rain sensor), or the sensitivity of the rain sensor.
2	LOW Slow wipe.
3	HIGH Continuous wipe.
4	1x Short wipe. Brief press, short clean.
5	Automatic wipe. The windscreen washer function is activated by pushing the lever forwards, and simultaneously the windscreen wipers start.
6	Interval wipe for rear window. The wiper will wipe the window approximately every six seconds.
7	The rear window wash function is activated by pressing the lever, and the rear wiper starts simultaneously.

» in Windscreen wiper and window wiper on page 152

» page 152

SOS » page 73

Easy Connect

CAR menu settings

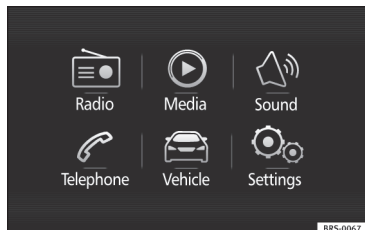

Fig. 45 Easy Connect: Main menu.

The actual number of menus available and the name of the various options will depend on the vehicle's electronics and equipment.







- Switch the ignition on.
- If the Infotainment System is off, switch it on.
- Press the Infotainment button  /  and then the  function button **» Fig. 45**,



Fig. 46 Easy Connect: CAR menu.

or, press the Infotainment button  /  to go to the **Vehicle** menu **» Fig. 46**.

- Press the  function button to open the **Vehicle settings** menu.
- To select a function in the menu, press the desired button.

When the function button check box is activated , the function is active.

Pressing the menu button  will always take you to the last menu used.

Any changes made using the settings menus are automatically saved on closing those menus.

The essentials

Menu	Submenu	Possible setting	Description
ESC system	–	Activation of the Electronic Stability Programme (ESC)	» page 183
Tyres	Tyre monitor system	Tyre pressure storing (Calibration)	» page 278
	Winter tyres	Activation and deactivation of the speed warning. Setting the speed warning value	» page 280
Lights	Light assist	Motorway function, turning-on time, automatic lights when raining, one-touch signalling.	» page 146, » page 149
	Vehicle interior lighting	Brightness of instrument panel and controls	» page 150
	"Coming home/Leaving home" function	Switch-on time of the "Coming home" and "Leaving home" functions	» page 148
Driver assistance	Adaptive Cruise Control (ACC)	Activation/deactivation: default distance level, driving profiles.	» page 216
	Front Assist (emergency brake assist system)	Activation/deactivation: Front Assist, advance warning, distance warning display	» page 212
	Fatigue detection	Activation/deactivation	» page 227
Parking and manoeuvring	Parking and manoeuvring settings	Automatically activate front volume, front sound treble, rear volume, rear sound treble	» page 232
Ambient lighting	–	Background lighting, switch-off, colour	» page 151
Mirrors and windscreen wipers	Rear view mirrors	Activate/deactivate folding after parking	» page 153
	Windscreen wipers	Activate and deactivate automatic wipe in case of rain, wipe when reversing	» page 33
Opening and closing	Electric windows control	Convenience open function, all, only driver	» page 143
	Central locking system	Unlocking doors, automatic lock when driving	» page 132
Instrument panel	–	Current consumption, average consumption, convenience consumers, ECO Advice, travelling time, distance travelled, average speed, digital speed display, speed warning, oil temperature, reset data "when setting off", reset data for "total calculation"	» page 38
Date and time	–	Time, summer time, time zone, time format, date, date format	» page 119



The essentials

Menu	Submenu	Possible setting	Description
Units	–	Distance, speed, temperature, volume, fuel consumption, pressure	–
Service	–	Chassis number, date of next SEAT service inspection, date of next oil change service	» page 43
Factory settings	A11	Restore all settings	–
	Individual	Restore factory settings for lights, driver assistance, parking and manoeuvring	–



»  in Car menu on page 123

Driver information System

Introduction

With the ignition switched on, it is possible to read the different functions of the display by scrolling through the menus.

In vehicles with multifunction steering wheel, the multifunction display can only be operated with the steering wheel buttons.

The number of menus displayed on the instrument panel will vary according to the vehicle electronics and equipment.

A specialised workshop will be able to programme or modify additional functions, according to the vehicle equipment. SEAT recommends visiting a SEAT Official Service.

Some menu options can only be read when the vehicle is at a standstill.

As long as a priority 1 warning is displayed, it will not be possible to read the menus » page 41. Some warning messages can be confirmed and made to disappear with the windscreen wiper lever button or the multifunction steering wheel button.

The information system also provides the following information and displays (depending on the vehicle's equipment):

Driving data » page 38

- MFD from departure

- MFD from refuelling
- MFD total calculation

Assist systems » page 40

Navigation » Booklet Navigation system

Audio » Booklet Radio or » Booklet Navigation system

Telephone » Booklet Radio or » Booklet Navigation system

Vehicle status » page 34

⚠ WARNING

Any distraction may lead to an accident, with the risk of injury.

- Do not operate the instrument panel controls when driving.

Operating the instrument panel menus

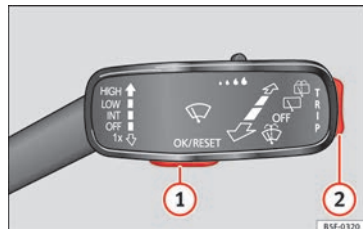

Fig. 47 Windscreen wiper lever: control buttons.

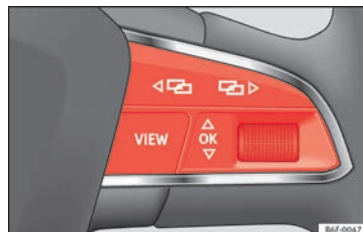

Fig. 48 Right side of multifunction steering wheel: control buttons.

The driver information system is controlled with the multifunction steering wheel buttons » Fig. 48 or with the windscreen wiper lever » Fig. 47 (if the vehicle is not equipped with multifunction steering wheel).

Enabling the main menu

- Switch the ignition on.
- If a message or vehicle pictogram appears, press button **» Fig. 47 ①** on the windscreen wiper lever or button **OK** on the multifunction steering wheel **» Fig. 48**.
- *If managed from the windscreen wiper lever:* to display the main screen or to return to the main menu from another menu, hold down the rocker button **» Fig. 47 ②**.
- *If managed from the multifunction steering wheel:* the main menu list is not displayed. To go from point to point in the main menu, press button **< >** or **> <** several times **» Fig. 48**.

Select a submenu

- Press the rocker switch **» Fig. 47 ②** on the windscreen wiper lever up or down or turn the thumbwheel of the multifunction steering wheel **» Fig. 48** until the desired option appears marked on the menu.
- The selected option will be displayed with a horizontal line underneath.
- To consult the submenu option, press button **» Fig. 47 ①** on the windscreen wiper lever or button **OK** on the multifunction steering wheel **» Fig. 48**.

Making changes according to the menu

- Make the desired changes with the rocker switch on the windscreen wiper lever or the

thumbwheel of the multifunction steering wheel. To increase or decrease the values more quickly, turn the thumbwheel faster.

- Mark or confirm the selection with button **» Fig. 47 ①** on the windscreen wiper lever or button **OK** on the multifunction steering wheel **» Fig. 48**.

Selection menu

Menu	Function
Driving data	Information and possible configurations of the multifunction display (MFD) » page 38, » page 123 .
Assist systems	Information and possible configurations of the driver assistance systems » page 40 .
Navigation*	Information instructions from the activated navigation system: when a route guidance is activated, the turning arrows and proximity bars are displayed. The appearance is similar to the Easy Connect system. If route guidance is not activated, the direction of travel (compass) and the name of the street along which you are driving are shown » Booklet Navigation system .
Audio	Station display on the radio. Track name on the CD. Track name in Media mode » Booklet Radio or » Booklet Navigation system .

Menu	Function
Telephone	Information and possible configurations of the mobile phone preinstallation » Booklet Radio or » Booklet Navigation system .
Vehicle status	Display of the current warning or information texts and other system components, depending on the equipment » page 123 .

Journey data

The MFD (multifunction display) shows different values for the journey and the consumption.

Changing between display modes on the MFD

- *In vehicles without multifunction steering wheel:* Press the rocker switch **TRIP** on the windscreen wiper lever **» Fig. 47**.
- *Vehicles with a multifunction steering wheel:* turn the thumbwheel **» Fig. 48**.

Multifunction display memory

The multifunction display is equipped with three memories that work automatically: MFD from departure, MFD from refuelling and MFD total calculation. On the screen display, you can read which memory is currently displayed.

Toggle between memories with the ignition on and the memory displayed

Press the **OK/RESET** button on the windscreen wiper lever or the **OK** button of the multifunction steering wheel.

Menu	Function
MFD from departure	Display and storage of the values for the journey and the consumption from when the ignition is switched on to when it is switched off. If the journey is continued in less than 2 hours after the ignition is switched off, the new data is added to the data already stored in the memory. The memory will automatically be deleted if the journey is interrupted for more than 2 hours.
MFD from re-fuelling	Display and storage of the values for the journey and the consumption. By refuelling, the memory will be erased automatically.
MFD total calculation	The memory records the values for a specific number of partial trips, up to a total of 19 hours and 59 minutes or 99 hours and 59 minutes, or 1999.9 km or 9999 km, depending on the model of instrument panel. On reaching either of these limits ^{a)} , the memory is automatically erased and starts to count from 0 again.

^{a)} It varies according to the instrument panel version.

Erasing a memory manually

- Select the memory that you wish to erase.
- Hold the **OK/RESET** button of the multifunction steering wheel or the **OK** button of the multifunction wheel pressed down for about 2 seconds.

Personalising the displays

In the Easy Connect system you can adjust which of the possible displays of the MFD can be shown on the instrument panel display with the **CAR** button and the **SETTINGS** function button **»»**  **page 123**.

Data summary

Menu	Function
Current fuel consumption	The current fuel consumption display operates throughout the journey, in litres/100 km; and with the engine running and the vehicle stopped, in litres/hour.
Average fuel consumption	After turning on the ignition, average fuel consumption in litres/100 km will be displayed after travelling about 300 metres. Otherwise horizontal lines are displayed. The value shown is updated approximately every 5 seconds.

Menu	Function
Operating range	Approximate distance in km that can still be travelled with the fuel remaining in the tank, assuming the same style of driving is maintained. This is calculated using the current fuel consumption.
Travelling time	This indicates the hours (h) and minutes (min) since the ignition was switched on.
Journey	Distance covered in km (m) after switching on the ignition.
CNG quality	Whenever you refuel the quality of the natural gas is automatically verified and is displayed when the ignition is switched on. The display is made in a percentage of between 70% and 100%. The greater the percentage displayed the lower the consumption may be.
Average speed	The average speed will be shown after a distance of about 100 metres has been travelled. Otherwise horizontal lines are displayed. The value shown is updated approximately every 5 seconds.
Digital display of speed	Current speed displayed in digital format. »»

Menu	Function
Speed warning at --- km/h or Speed warning at --- mph	If the stored speed is exceeded (between 30 - 250 km/h, or 19 - 155 mph), an audible warning is given together with a visual warning.
Oil temperature	Updated engine oil temperature digital display
Coolant temperature gauge	Digital display of the current temperature of the liquid coolant.
Convenience consumers	Information about the vehicle's main convenience consumers. It is displayed by means of a consumption indicator bar.
Eco tips	Tips on how to save fuel.
Reset data "when setting off"	Reset journey data when setting off.
Reset data for "total calculation"	Reset travel journey to zero.

Storing a speed with the speed warning

- Select the display **Speed warning at --- km/h (--- mph)**
- Press the button **OK/RESET** on the windscreen wiper lever or the button **OK** on the multifunction steering wheel to store the current speed and activate the warning.
- To switch system on: adjust to the desired speed within 5 seconds using the rocker

switch **TRIP** on the windscreen wiper lever or by turning the thumbwheel on the multifunction steering wheel. Next, press the button **OK/RESET** or **OK** again or wait several seconds. The speed is stored and the warning activated.

- To switch system off: press the button **OK/RESET** or **OK**. The stored speed is deleted.

Assist systems menu

Menu	Function
ACC	Display of Adaptive Cruise Control (ACC) » page 216.
Front Assist	Switching the monitoring system on and off » page 212.
Fatigue detection*	Switching the fatigue detection on or off (pause recommendation) » page 227.

Status display

Bonnet, rear lid and doors open

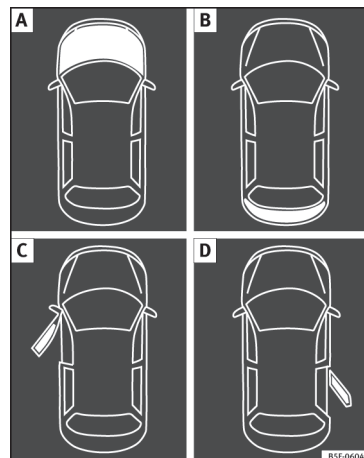





Fig. 49 A: bonnet open; B: rear lid open; C: front left door open; D: right rear door open.

When the ignition is switched on or when driving, the bonnet, rear lid or doors that are open will be indicated on the instrument panel display, and, as applicable, this will be indicated audibly. The display may vary according to the type of instrument panel fitted.

Illustration	Key to »» Fig. 49
A	 Do not continue driving! The bonnet is open or is not properly closed »» page 263.
B	 Do not continue driving! The rear lid is open or is not properly closed »» page 16.
C, D	 Do not continue driving! A vehicle door is open or is not properly closed »» page 132.





»» page 118

Warning and information messages

The system runs a check on certain components and functions when the ignition is switched on and while the vehicle is moving. Faults in the operation are displayed on the screen using red and yellow symbols and messages on the instrument panel display (»»  page 122, »» page 47) and, in some cases, with audible warnings. The display may vary according to the type of instrument panel fitted.

Priority 1 warning (red symbols)

Symbol flashing or lit; partly combined with audible warnings.

 **Stop the vehicle!** It is dangerous »»  in Warning symbols on page 122 !

Check the function that is faulty and repair it. If necessary, request assistance from specialised personnel.

Priority 2 warning (yellow symbols)

Symbol flashing or lit; partly combined with audible warnings.

A faulty function, or fluids which are below the correct levels may cause damage to the vehicle! »»  in Warning symbols on page 123

Check the faulty function as soon as possible. If necessary, request assistance from specialised personnel.

Informative text

Information relating to different vehicle processes.



»» page 122

Gear-change indicator

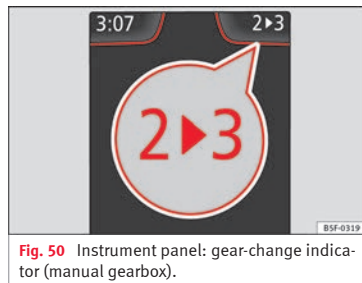





Fig. 50 Instrument panel: gear-change indicator (manual gearbox).

Gear-change recommendation

While driving, the instrument panel of certain vehicles may indicate a gear recommendation for saving fuel »»  page 197.

Outside temperature display



When the outside temperature is below +4°C (+39°F), the  symbol (warning of risk of freezing) is displayed. At first, this symbol flashes and then it remains lit until the outside temperature rises above +6°C (+43°F) »»  in Indications on the display on page 119.

When the vehicle is at a standstill or when travelling at very low speeds, the temperature displayed may be higher than the true »»



outside temperature as a result of the heat produced by the engine.

The temperatures measured range from -40°C to +50°C (-40°F to +122°F).

Engine oil temperature display

The engine reaches its operating temperature when in normal driving conditions the oil temperature is between **80°C** (178°F) and **120°C** (248°F). If the engine is required to work hard and the outside temperature is high, the engine oil temperature can increase. This does not present any problem as long as the warning lamps  » [table on page 48](#) or  » [table on page 48](#) do not appear on the display.

Vehicles without multifunction steering wheel



- Press the rocker switch » [Fig. 47](#)  until the main menu appears. Enter into **Driving data**. With the button  move to the oil temperature gauge.

Vehicles with multifunction steering wheel

- Enter the submenu **Driving data** and turn the thumbwheel until the oil temperature display appears.

Additional consumers

- *Operation with the windscreen wiper lever**: Press the rocker switch » [Fig. 47](#)  until the main menu appears. Enter into the section **Driving data**. With the rocker switch, move to the display **Convenience consumers**.

- *Operation with the multi-function steering wheel**: move with the buttons  or  to **Driving data** and enter with **OK**. Turn the right thumbwheel until the **Convenience consumers** display appears.

In addition, a scale will inform you of the current sum of all the additional appliances.

Saving tips

Tips on how to save fuel will be displayed in conditions that increase fuel consumption. Follow them to reduce consumption. The indications appear automatically only with the efficiency programme. After a time, the tips will disappear automatically.



If you wish to hide a saving tip immediately after it appears, press any button on the windscreen wiper lever*/multifunction steering wheel*.



Note

- If you hide a saving tip, it will reappear after you switch the ignition on again.
- The saving tips do not appear in all situations, but rather with a large separation of time.



Speed warning device

The speed warning device warns the driver when they have exceeded the pre-set speed limit by 3 km/h (2 mph). An audible warning signal sounds, and the warning lamp  and the driver message **Speed limit exceeded!** will be displayed simultaneously on the instrument panel. The warning lamp  switches off when reducing speed below the stored maximum limit.

Speed warning programming is recommended if you wish to be reminded of a maximum speed, such as when travelling in a country with different speed limits or for a maximum speed for winter tyres.

Setting speed limit warning

You can use the radio or the Easy Connect* to set, alter or cancel the speed limit warning.

- *Vehicles with radio*: press the  button » control button  **Driver Assistant** » **Speed warning**.

- **Vehicles with Easy Connect:** Press the **CAR** button and the function button **SETTINGS** > **Driver assistance** > **ACC** > **Distance**.

The warning limit can be set from 30 to 210 km/h (18 to 150 mph) »»  page 209. The adjustment is made at 10 km/h (6 mph) intervals.

Note

- Please bear in mind that, even with the speed warning function, it is still important to keep an eye on the vehicle speed with the speedometer and to observe the legal speed limits.
- The speed limit warning function in the version for some countries warns you at a speed of 120 km/h (75 mph). This is a factory-set speed limit.

Service intervals

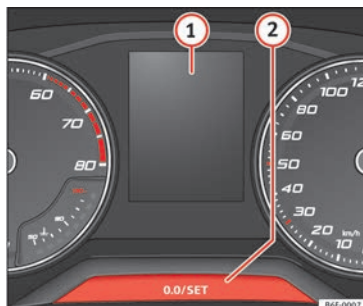

Fig. 51 Instrument panel

The service interval indication appears on the instrument panel display »» Fig. 51 ①.

SEAT distinguishes between services *with* engine oil change (e.g. Oil change service) and services *without* engine oil change (e.g. Inspection).

In vehicles with **Services established by time or mileage**, the service intervals are already pre-defined.

In vehicles with **LongLife Service**, the intervals are determined individually. Thanks to technological progress, maintenance work has been greatly reduced. Because of the technology used by SEAT, with this service you only need to change the oil when the ve-

hicle so requires. To calculate this change (max. 2 years), the vehicle's conditions of use and individual driving styles are considered. The advance warning first appears 20 days before the date established for the corresponding service. The kilometres (miles) remaining until the next service are always rounded up to the nearest 100 km (miles) and the time is given in complete days. The current service message cannot be viewed until 500 km after the last service. Prior to this, only lines are visible on the display.

Inspection reminder

When the Service date is approaching, when the ignition is switched on a **Service reminder** is displayed.

Vehicles without text messages: a spanner  will be displayed on the instrument panel plus an indication in **km**.

The kilometres indicated are the maximum number of kilometres that can be travelled until the next service. After a few seconds, the display mode changes. A clock symbol appears and the number of days until the next service is due.

Vehicles with text messages: **Service in --- km or --- days** will be shown on the instrument panel display. »»



Service due

When **the service date is due**, an audible warning is given when the ignition is switched on and the spanner displayed on the screen flashes for a few seconds .

Vehicles with text messages: **Service now** will be shown on the instrument panel display.

Reading a service notification

With the ignition switched on, the engine off and the vehicle at a standstill, the current **service notification** can be read:



Press and hold the button  for more than 5 seconds to consult the service message .

When the **service date has passed**, a minus sign is displayed in front of the number of kilometres or days.



Vehicles with text messages: the following message is displayed: **Service --- km (miles) or --- days ago.**

Resetting service interval display

If the service was not carried out by a SEAT dealership, the display can be reset as follows:

- Switch off the ignition, press and hold the button  .
- Switch ignition back on.
- Release the button  and press it again for the next 20 seconds.

Note

- **The service message disappears after a few seconds, when the engine is started or when  is pressed on the windscreen wiper lever, or  on the multifunction steering wheel.**
- **In vehicles with the LongLife system in which the battery has been disconnected for a long period of time, it is not possible to calculate the date of the next service. Therefore**

the service interval display may not be correct. In this case, bear in mind the maximum service intervals permitted in the » Booklet Maintenance Programme.

- **If you reset the display manually, the next service interval will be indicated as in vehicles with fixed service intervals. For this reason we recommend that the service interval display be reset by a SEAT authorised Dealer.**

Cruise control

Operating the cruise control system (CCS)*



Fig. 52 Related video:
Dash panel

BKJ-0115

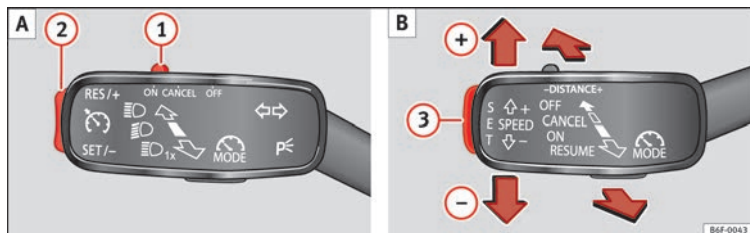

Fig. 53 On the left of the steering column: **A** controller and buttons to operate the cruise control system; **B** third lever to operate the cruise control system.

Function	Position of the turn signal lever » Fig. 53 A or of the third lever » Fig. 53 B	Effect
Switching on the cruise control system	Move controller 1 to the ON position on the turn signal lever or move the third lever forward.	The system switches on. The last set speed of the cruise control is stored. It does not take effect yet.
Switching on the cruise control system	Press the button 2 on the turn signal lever or button SET 3 on the third lever.	The current speed is stored and the cruise control is activated.
Temporarily switching off the cruise control	Move controller 1 of the turn signal lever to the CANCEL position or move the third lever into pressure point CANCEL .	The limiter is switched off temporarily. The speed will be stored.



The essentials

Function	Position of the turn signal lever » Fig. 53 A or of the third lever » Fig. 53 B	Effect
Switching on the cruise control system again	Press the button ② on the turn signal lever or move the third lever into the pressure point RESUME .	The set speed control is activated.
Increasing the set speed of the cruise control	Briefly press the button ② on the turn signal lever in the area RES/+ or press SET ③ on the third lever to increase the speed in small increments of 1 km/h (1 mph) and set it.	The speed is changed to the set value.
	Press SPEED+ on the third lever to increase the speed in increments of 10 km/h (5 mph) and set it. Hold down the button ② on the turn signal lever in the RES/+ area or hold down SPEED+ to increase continuously in increments of 10 km/h (5 mph) and set it.	
Reducing the set speed of the cruise control	Briefly press the button ② on the turn signal lever in the SET/- area or move the third lever into position RESUME to reduce the speed in small increments of 1 km/h (1 mph) and set it.	The speed is changed to the set value.
	Press SPEED- on the third lever to reduce the speed in increments of 10 km/h (5 mph) and set it. Hold down the button ② on the turn signal lever in the SET/- area or hold down SPEED- to continuously decrease the speed in increments of 10 km/h (5 mph), then set it.	
Switching off the cruise control system	Move controller ① of the turn signal lever into position OFF or the third lever into position OFF .	The system switches off. The set speed will be stored.



» ⚠ in How it works on page 208



» page 207

Warning lamps

On the instrument panel



BKJ-0115

Fig. 54 Related video:
Dash panel



BKJ-0127

Fig. 55 Instrument panel, on dash panel.

Red warning lamps









	Central warning lamp: additional information on the instrument panel display	–
	Parking brake on.	» page 182





	Do not continue driving! The brake fluid level is too low or there is a fault in the brake system.	» page 181
	<i>Lit up or flashing:</i> Do not continue driving! Fault in the steering.	» page 198

	Driver or passenger has not fastened seat belt.	» page 81
	Use the foot brake!	» page 218









Yellow warning lamps



	Central warning lamp: additional information on the instrument panel display	-
	Front brake pads worn.	» page 181
	<i>it lights up:</i> Fault in the ESC, or disconnection caused by the system. <i>flashes:</i> ESC or ASR activated.	» page 183
	<i>it lights up:</i> fault in the ASR or disconnection caused by the system. <i>flashes:</i> ASR working.	» page 184
	ASR manually deactivated. <i>Or else:</i> ESC in Sport mode.	» page 183
	ABS faulty or does not work.	» page 187
	Rear fog light switched on.	» page 31
	<i>lights up or flashes:</i> fault in the emission control system.	» page 203
	<i>it lights up:</i> pre-heating of diesel engine. <i>flashes:</i> fault in the diesel engine management.	» page 203
EPC	fault in the petrol engine management.	» page 203

	<i>lights up or flashes:</i> fault in the steering system.	» page 198
	Tyre pressure too low, or fault in the tyre pressure monitoring system.	» page 278
	Fuel tank almost empty.	» page 121
	Fault in airbag system and seat belt tensioners.	» page 91

Other warning lamps

	Left or right turn signal.	» page 32
	Hazard warning lights on.	» page 32 » page 150
	Trailer turn signals	» page 243
	<i>it lights up green:</i> Press the brake pedal! <i>It blinks in green:</i> the selector lever locking button has not engaged.	» page 190
	<i>it lights up green:</i> cruise control activated or speed limiter switched on and active. <i>it blinks in green:</i> the speed set by the speed limiter has been exceeded.	» page 45 » page 209
	Main beam on or flasher on.	» page 32

	Natural gas operating mode	» page 121
--	----------------------------	------------

 »  in Warning symbols on page 122

 » page 122

On the instrument panel display

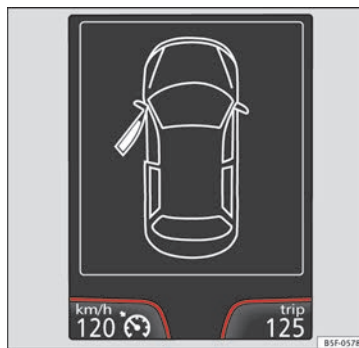

















Fig. 56 On the instrument panel display: door open.

 **Do not continue driving!**
With the corresponding indication: door(s), rear lid or bonnet open or not properly closed.

» page 40

	Ignition:  Do not carry on driving! Engine coolant level too low, coolant temperature too high	» page 269
	Flashing: Fault in the engine coolant system.	
	Do not continue driving! Engine oil pressure too low.	» page 267
	Fault in the battery.	» page 272
	Driving light totally or partially faulty.	» page 106
	Fault in the cornering light system.	» page 149
	particulate filter blocked.	» page 202
	Flashing: Fault in the oil level detection. Control manually.	» page 267
	Ignition: Insufficient engine oil.	
	Fault in the gearbox.	» page 196
SAFE	Immobiliser active.	» page 177
	Service interval display	» page 43

	Mobile telephone is connected via Bluetooth to the original telephone device.	» page 124 » page 129 » Booklet Audio or navigation system
	Mobile telephone battery charge meter. Available only for devices pre-installed in factory.	
	Freezing warning. The outside temperature is lower than +4°C (+39°F).	» page 41
	Start-Stop system activated.	» page 204
	Start-Stop system unavailable.	
ECO	Low consumption driving status	» page 225





» page 118

On the instrument panel



Fig. 57 Warning lamp for disabling the front passenger airbag.

	Front passenger front airbag is disabled (PASSENGER AIR BAG OFF).	» page 90
	The front passenger front airbag is activated (PASSENGER AIR BAG ON).	» page 90



»  in Activation and deactivation of front passenger airbag* on page 91



» page 90

Gearbox lever

Manual gearbox

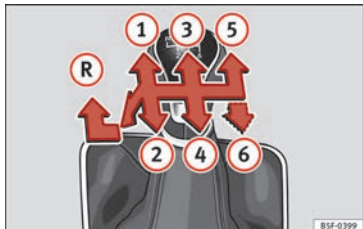

Fig. 58 Gear shift pattern of a 5 or 6-speed manual gearbox.

The position of the gears is indicated on the gearbox lever » **Fig. 58**.

- Press the clutch pedal and keep your foot right down.
- Move the gearbox lever to the required position.
- Release the clutch.

Selecting reverse gear

- Press the clutch pedal and keep your foot right down.
- With the gearbox lever in neutral, push it downwards, move it to the left as far as it will go and then forwards to select reverse » **Fig. 58 (R)**.

- Release the clutch.



» ⚠ in Driving with a manual gearbox on page 189



» page 189

Automatic gearbox*

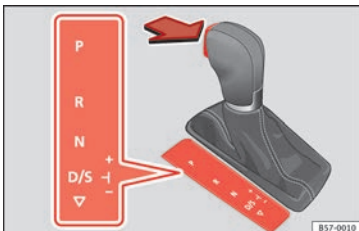

Fig. 59 Automatic gearbox: selector lever positions.

P Parking lock

R Reverse gear

N Neutral (idling)

D/S Drive (forward)

+/- Tiptronic mode: pull the lever forwards (+) to go up a gear or backwards (-) to go down a gear.



» ⚠ in Selector lever positions on page 191



» page 190

SOS

» page 50

Manual release of the selector lever

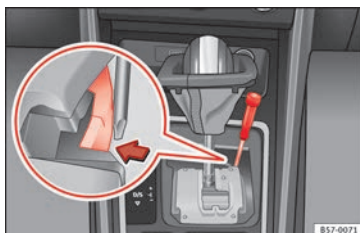



Fig. 60 Selector lever: manual release from position P.

Should the power supply be interrupted, there is a manual unlocking device located under the console of the selector lever, on the right. Releasing the selector lever requires a certain degree of practical skill.

- Unlocking: use the flat part of a screwdriver blade.

Removing the cover from the selector lever

- Apply the handbrake   to ensure that the car does not move.
- Carefully pull the corners of the selector lever boot and twist it upwards above the lever handle.

Releasing the selector lever

- Using a screwdriver, press and hold the yellow unlocking tab sideways  **Fig. 60**.
- Press the interlock button on the selector lever and move the selector lever to position **N**.
- After carrying out the manual release, attach the selector lever boot on the gearbox console again.

If the power supply should ever fail (e.g. discharged battery) and the vehicle has to be pushed or towed, the selector lever must first be moved to position **N**, after operating the manual release mechanism.

 WARNING

The selector lever may be moved out of position P only when the handbrake is firmly applied. If this does not work, secure the vehicle with the brake pedal. On a slope the vehicle could otherwise start to move inadvertently after shifting the selector lever out of position P - accident risk!

Air conditioning**Related video**

BKJ-0112

Fig. 61 Air conditioning

How does Climatronic* work?

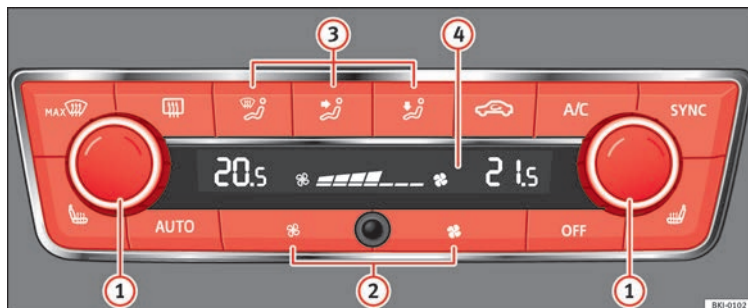









Fig. 62 In the centre console: Climatronic controls

To switch a specific function on, press the appropriate button. Press the button again to switch off the function.

The LED on each control lights up to indicate that the respective function of a control has been switched on.

<p>① Temperature</p>	The left and right sides can be adjusted separately: turn the control to adjust the temperature.
<p>② Fan</p>	The power of the fan is automatically adjusted. Press the buttons to manually adjust the fan.
<p>③ Air distribution</p>	The airflow adjusts automatically for comfort. You can also switch it on manually using the buttons ③.
<p>④</p>	Indications on the display screen of the fan speed and the temperature selected for the right and left sides.
<p>MAX  Defrost function</p>	The air drawn in from outside the vehicle is directed at the windscreen and air recirculation is automatically switched off. To defrost the windscreen more quickly, the air is dehumidified at temperatures over approximately +3°C (+38°F) and the fan runs at maximum output.
<p></p>	The air is directed at the chest of driver and passengers by the dash panel air vents.

The essentials

	Air distribution towards the footwell.
	Upward air distribution.
	Heated rear window: this only works when the engine is running and switches off automatically after a maximum of 10 minutes.
	Air recirculation
	Seat heating buttons
A/C	Press the button to switch on or off the cooling system.
SYNC	Press the SYNC button to apply the driver-side settings to the passenger side. Use the temperature regulator for the passenger side in order to set a different temperature.
AUTO	Automatic adjustment of temperature, fan, and air distribution.
Switching off	Press the OFF button or manually set the fan to 0 .



» »  in General notes on page 166



» » page 173

How does the manual air conditioning work*?





Fig. 63 In the centre console: Manual air conditioning controls.

To switch a specific function on, press the appropriate button. Press the button again to switch off the function.

The LED on each control lights up to indicate that the respective function of a control has been switched on.

<p>① Temperature</p>	<p>Turn the control to adjust the temperature.</p>
<p>② Fan</p>	<p>Setting 0: blower and manual air conditioning switched off Level 4: maximum fan level.</p>
<p>③ Air distribution</p>	<p>: Defrost function. The airflow is directed at the windscreen. Air recirculation is automatically switched off or is not switched on. Increase the fan power to clear the windscreen of condensation as soon as possible. To dehumidify the air, the cooling system will automatically switch on. : The air is directed at the chest of driver and passengers by the dash panel air vents. : Air distribution to footwells. : Air distribution towards the windscreen and the footwell.</p>
<p></p>	<p>Heated rear window: this only works when the engine is running and switches off automatically after a maximum of 10 minutes.</p>

The essentials

	Air recirculation
A/C	Press the button to switch on or off the cooling system.
	Seat heating buttons



» »  in General notes on page 166



» » page 171

How does the heating and the fresh air system work?

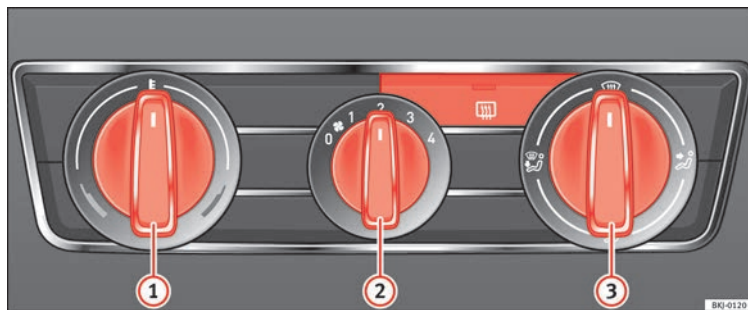







Fig. 64 In the centre console: heating system and fresh air controls.

To switch a specific function on, press the appropriate button. Press the button again to switch off the function.

The LED on each control lights up to indicate that the respective function of a control has been switched on.



The essentials

① Temperature	Turn the control to adjust the temperature. The temperature cannot be lower than that of the exterior air temperature, as this system cannot cool or dehumidify the air.
② Fan	Setting 0: blower and manual air conditioning switched off Level 4: maximum fan level.
③ Air distribution	 : Defrost function. The airflow is directed at the windscreen.  : The air is directed at the chest of driver and passengers by the dash panel air vents.  : Air distribution to footwells.  : Air distribution towards the windscreen and the footwell.
	Heated rear window: this only works when the engine is running and switches off automatically after a maximum of 10 minutes.



»  in General notes on page 166



» page 169

Fluid Level control

Filling capacities

Capacities

Fuel tank	40 litres. 7 litre reserve.
Windscreen washer fluid container	3 litres

Fuel

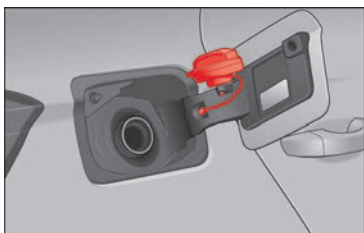

Fig. 65 Fuel tank flap with tank cap attached.

The tank flap is released electronically by means of the central locking and is located at the rear of the vehicle, on the right. The tank holds approximately 40 litres.

Opening the fuel tank cap

- Open the fuel tank flap by pressing on the left side.
- Unscrew the cap by turning it to the left.
- Place it in the space on the hinge of the open flap » **Fig. 65**.

Closing the fuel tank cap

- Unscrew the cap by turning it to the right as far as it will go.
- Close the lid.



»  in Refuelling on page 257



» page 257

Oil

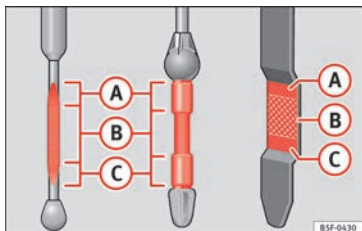

Fig. 66 Engine oil dipstick.

The level is measured using the dipstick located in the engine compartment

»  page 266.

The oil should leave a mark between zones **A** and **C**. It should never exceed zone **A**.

- Zone **A**: Do not add oil.
- Zone **B**: You can add oil but keep the level in that zone.



Fig. 67 In the engine compartment: Engine oil filler cap.

- Zone **C**: Add oil up to zone **B**.

Topping up engine oil

- Unscrew cap from oil filler opening.
- Add oil slowly.
- At the same time, check the level to ensure you do not add too much.

- When the oil level reaches at least zone **B**, unscrew the engine oil filler cap carefully.

Engine oil additives

No type of additive should be mixed with the engine oil. The deterioration caused by these additives is not covered by the warranty.

Engine oil specifications

Service interval	Engine type	Specification
Petrol engines with Set Service Intervals (dependent on time/distance travelled)	1.0l / 1.0l GNC / 1.5l	VW 504 00
	1.0l / 1.6l	VW 502 00 ^{a)}
Petrol engines with Flexible Service Intervals (LongLife)	1.0l / 1.5l	VW 508 00 VW 504 00 ^{b)}
Diesel engines with Set Service and Flexible Service Intervals ^{c)}	With particulate filter (DPF)	VW 507 00

- a) If the quality of the fuel available in the country does **not** fulfil the EN 228 (for petrol) and EN 590 (for diesel) standards.
- b) Use of engine oil compliant with the VW 504 00 specification instead of VW 508 00 may have a slight negative effect on the vehicle's exhaust gas values.
- c) Only use recommended oils, otherwise you may damage the engine.



» ⚠ in Changing engine oil on page 269



» page 266

Coolant



Fig. 68 Engine compartment: coolant expansion tank cap.

The coolant tank is located in the engine compartment »  page 266.

When the engine is cold, replace the coolant when the level is below **MIN**.

Coolant specifications

The engine cooling system is supplied from the factory with a specially treated mixture of water and at least 40 % of the additive **G13** (TL-VW 774 J), purple. This mixture gives the necessary frost protection down to -25°C (-13°F) and protects the light alloy parts of the engine cooling system against corrosion. It also prevents scaling and considerably raises the boiling point of the coolant.

To protect the cooling system, the percentage of additive must always be at least 40 %, even in warm climates where anti-freeze protection is not required. »

If for weather reasons further protection is necessary, the proportion of additive may be increased, but only up to 60 %; otherwise antifreeze protection will diminish and this will worsen cooling.

When the coolant is topped up, use a mixture of **distilled water** and at least 40 % of the G13 or G12 plus-plus (TL-VW 774 G) additive (both are purple) to obtain an optimum anti-corrosion protection » » ⚠ in **Topping up coolant** on page 271. The mixture of G13 with G12 plus (TL-VW 774 F), G12 (red) or G11 (green-blue) engine coolants will significantly reduce anti-corrosion protection and should therefore be avoided » » ⚠ in **Topping up coolant** on page 271.



» » ⚠ in **Topping up coolant** on page 270



» » page 269

Brake fluid



Fig. 69 Engine compartment: brake fluid reservoir cap.

The brake fluid reservoir is located in the engine compartment » » 📖 page 266.

The level should be between the **MIN** and **MAX** marks. If it is below **MIN**, please visit a Technical Service.



» » ⚠ in **Changing the brake fluid** on page 271



» » page 271

Windscreen washer

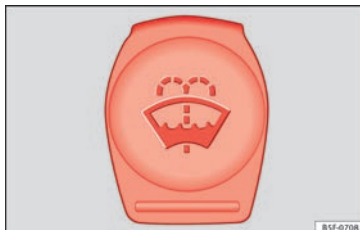

Fig. 70 In the engine compartment: windscreen washer reservoir top.

The windscreen washer reservoir is located in the engine compartment » » 📖 page 266.

To top up, mix water with a product recommended by SEAT.

In cold temperatures, add anti-freeze for windows.



» » ⚠ in **Checking and topping up the windscreen washer reservoir water** on page 272



» » page 272

Battery

The battery is located in the engine compartment » » 📖 page 266. It does not require

maintenance. It is checked as part of the Inspection Service.



» »  in Symbols and warnings on handling the battery on page 272



» » page 272

Emergencies

Fuses

Fuse location



Fig. 71 On the driver-side dash panel: fuse box cover.

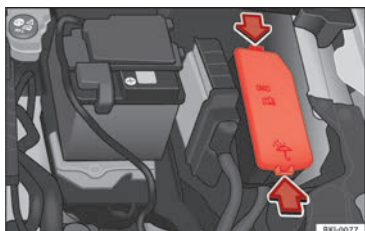

Fig. 72 In the engine compartment: fuse box cover.

Opening and closing the fuse box situated below the dash panel

- Opening: remove the fuse box cover in the direction indicated »» **Fig. 71**.
- Closing: click the cover back into place.

To open the engine compartment fuse box

- Raise the bonnet.
- Press the locking tabs to release the fuse box cover »» **Fig. 72**
- Then lift the cover out.
- To **fit** the cover, place it on the fuse box. Push the locking tabs down until they click audibly into place.

Identifying fuses situated below the dash panel by colours

Colour	Amp rating
Black	1
Purple	3
Light brown	5
Brown	7.5
Red	10
Blue	15
Yellow	20
White or transparent	25

Colour	Amp rating
Green	30
Orange	40



»» ⚠ in Introduction on page 104



»» page 104

Replacing a blown fuse

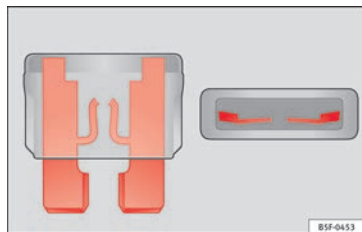



Fig. 73 Image of a blown fuse.

Preparation

- Switch off the ignition, lights and all electrical equipment.
- Open the corresponding fuse box »»  page 104.

Identifying a blown fuse

A fuse is blown if its metal strip is ruptured
 »» Fig. 73.

- Point a lamp at the fuse to see if it has blown.

To replace a fuse

- Remove the fuse.
- Replace the blown fuse by one with an *identical* amperage rating (same colour and markings) and *identical* size.
- Replace the cover again or close the fuse box lid.

Bulbs

Bulbs (12 V)

Note: Depending on the level of equipment fitted in the vehicle, LEDs may be used for part or all of the interior and/or exterior lighting. LEDs have an estimated life that exceeds that of the vehicle. If an LED light fails, go to an authorised workshop for its replacement.

Light source used for each function

Halogen headlights.	Type
Dipped beam headlights	H7 Long Life
Main beam headlights	H7

Halogen headlights.	Type
Side light/DRL (daytime running light)	W21W
Turn signal	PY 21W

Halogen headlight with LED DRL	Type
Dipped beam headlights	H7 Long Life
Main beam headlights	H7
Turn signal	PY 21W
Side light/DRL (daytime running light)	LED ^{a)}

^{a)} In case of a LED failure, go to an authorised workshop to have it replaced.

Full-LED main headlights	Type
No bulbs may be replaced. All functions are with LEDs. In case of a LED failure, go to an authorised workshop to have it replaced.	



»» page 106

Action in the event of a puncture

Related video



Fig. 74 Wheels

What to do first

- Park the vehicle on a horizontal surface and in a safe place as far away from traffic as possible.
- Apply the handbrake.
- Switch on the hazard warning lights.
- *Manual gearbox:* select the 1st gear.
- *Automatic gearbox:* Move the selector lever to position P.
- If you are towing a trailer, unhitch it from your vehicle.
- Have the vehicle tool kit* »» page 65 and the spare wheel »» page 279 ready.
- Observe the applicable legislation for each country (reflective vest, warning triangles, etc.).



- All occupants should leave the vehicle and wait in a safe place (for instance behind the roadside crash barrier).

⚠ WARNING

- Always observe the above steps and protect yourself and other road users.
- If you change the wheel on a slope, block the wheel on the opposite side of the car with a stone or similar to prevent the vehicle from moving.

Repairing a tyre with the anti-puncture kit

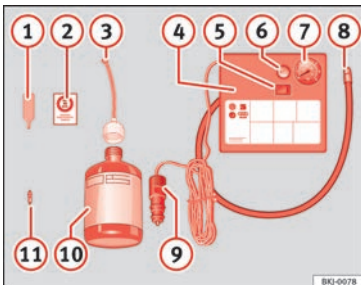

Fig. 75 Standard representation: contents of the anti-puncture kit.

The anti-puncture kit is located under the floor panel in the luggage compartment.

Sealing the tyre

- Unscrew the tyre valve cap and insert. Use the **»» Fig. 75 ①** tool to remove the insert. Place it on a clean surface.
- Shake the tyre sealant bottle vigorously **»» Fig. 75 ⑩**.
- Screw the inflator tube **»» Fig. 75 ③** into the sealant bottle. The bottle's seal will break automatically.
- Remove the lid from the filling tube **»» Fig. 75 ③** and screw the open end of the tube into the tyre valve.
- With the tyre sealant bottle upside down, fill the tyre with the contents of the sealant bottle.
- Remove the bottle from the valve.
- Place the insert back into the tyre valve using the tool **»» Fig. 75 ①**.

Inflating the tyre

- Screw the compressor tyre inflator tube **»» Fig. 75 ⑧** into the tyre valve.
- Check that the air bleed screw is closed **»» Fig. 75 ⑥**.
- Start the engine and leave it running.
- Insert the connector **»» Fig. 75 ⑨** into the vehicle's 12-volt socket **»» ① page 160**.
- Turn the air compressor on with the ON/OFF switch **»» Fig. 75 ⑤**.

- Keep the air compressor running until it reaches 2.0 to 2.5 bar (29-36 psi/200-250 kPa). **A maximum of 8 minutes.**
- Disconnect the air compressor.
- If it does not reach the pressure indicated, unscrew the tyre inflator tube from the valve.
- Move the vehicle 10m so that the sealant is distributed throughout the tyre.
- Screw the compressor tyre inflator into the valve.
- Repeat the inflation process.
- If the indicated pressure still cannot be reached, the tyre is too badly damaged. Stop and request assistance from an authorised technician.
- Disconnect the air compressor. Unscrew the tyre inflator tube from the tyre valve.
- When the tyre pressure is between 2.5 and 2.0 bars, continue driving without exceeding 80 km/h (50 mph).
- Check the pressure again after 10 minutes **»» ① page 99**.



»» ⚠ in TMS (Tyre Mobility System)* on page 98



»» page 98

Changing a wheel

Related video



BKJ-0114

Fig. 76 Wheels

Vehicle tool kit

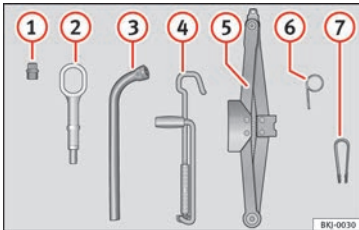

BKJ-0030

Fig. 77 Underneath the floor panel of the luggage compartment: vehicle tool kit.

- ① An adapter for the anti-theft wheel bolts*
- ② Towline anchorage
- ③ Box spanner for wheel bolts*
- ④ Crank handle for jack

- ⑤ Jack*
- ⑥ Hook for extracting the central wheel trims*
- ⑦ Clip for removing the wheel bolt caps.



» ⚠ in Vehicle tools on page 97



» page 97

Central trim for steel rims*



BKJ-0106

Fig. 78 Correct positioning of the central wheel trim for steel rims.

The central trims must be removed for access to the wheel bolts.

Removing

- Attach the wire hook (vehicle tools » Fig. 77 ⑥) to one of the chambers of the central wheel trim.
- Insert the box spanner through the hook, supporting it on the tyre and remove the wheel trim.

Fitting

- Fit the central wheel trim onto the rim. The bottom of the “S” of the SEAT badge should align with the inflation valve » Fig. 78 ①.
- Press the central trim firmly until it locks in with an audible click.

Note

There is also a valve mark on the back of the central wheel trim that indicates the correct alignment.

Central trim for alloy rims*

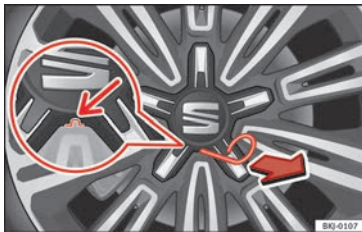

Fig. 79 Removing the central wheel trim.

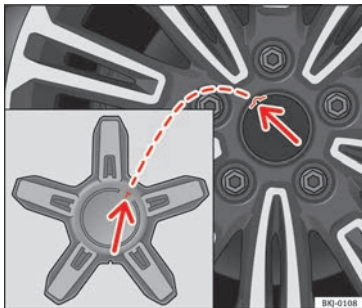

Fig. 80 Fitting the central wheel trim.

Removing

- Attach the wire hook (vehicle tools » Fig. 77 (6)) to the housing provided for this » Fig. 79.

- Pull on it to remove the trim » Fig. 79.

Fitting

- Fit the central wheel trim onto the rim, fitting the protrusion on the trim into the recess in the rim » Fig. 80 (arrows).
- Press the central trim firmly until it locks in with an audible click.

Wheel covers*

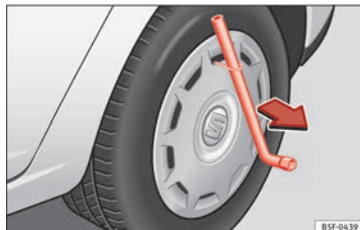

Fig. 81 Remove the wheel cover.

The wheel covers must be removed for access to the wheel bolts.

Removing

- Remove the wheel cover using the wire hook » Fig. 81.
- Hook this into one of the cut-outs of the wheel cover.

Fitting

- Fit the wheel cover onto the wheel rim by pressing it firmly.
- Put pressure on the point of the cut-out for the valve.
- Next fit the rest of the wheel cover.

Wheel bolt caps*



Fig. 82 Wheel: wheel bolts with caps.

Removal

- Fit the plastic clip (vehicle tools) over the cap until it clicks into place » Fig. 82.
- Remove the cap with the plastic clip.

Wheel bolts



Fig. 83 Changing a wheel: loosen the wheel bolts.

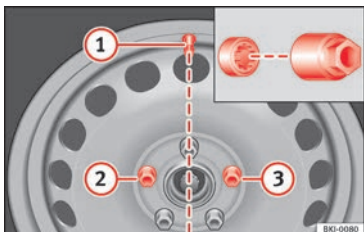

Fig. 84 Changing a wheel: tyre valve (1) and the correct position for the anti-theft wheel locking bolt (2) or (3).

Use only the wheel wrench belonging to the car to loosen the wheel bolts.

Loosen the wheel bolts only about one turn before raising the vehicle with the jack.

If the wheel bolt is very tight, carefully push on the end of the wheel wrench with your foot. Hold on to the vehicle for support and take care not to slip during this operation.

Loosening wheel bolts

- Fit the wheel wrench on as far as it will go »» **Fig. 83.**
- Hold the wrench at the end and rotate the bolt approximately *one* turn anticlockwise »» **Δ** in **Removing and fitting the wheel** on page 69.

The caps protect the wheel bolts and should be pushed fully on again after changing the tyre.

Loosening the anti-theft wheel bolt

- Take the adapter for the anti-theft wheel bolts out of the vehicle tool kit.
- Insert the adapter fully onto the anti-theft wheel bolt »» **Fig. 84.**
- Fit the wheel wrench as far as it will go over the adapter.
- Hold the wrench at the end and rotate the bolt approximately *one* turn anticlockwise »» **Δ** in **Removing and fitting the wheel** on page 69.

The **anti-theft wheel bolt** has a different cap. This cap only fits on anti-theft locking bolts and is not for use with standard wheel bolts.

Important information about wheel bolts

Factory-fitted rims and wheel bolts are specially matched during construction. Therefore, if different rims are fitted, the correct wheel bolts with the right length and heads must be used. This ensures that wheels are fitted securely and that the brake system functions correctly.

In certain circumstances, you should not even use wheel bolts from vehicles of the same model.

In wheels with full hubcaps, the anti-theft locking bolt must be threaded onto positions **2** »» **Fig. 84** or **3**, taking the tyre valve's position as reference **1**. Otherwise it will not be possible to mount the hubcap.

Raising the vehicle

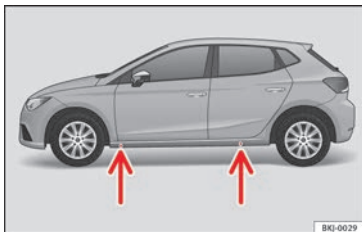

Fig. 85 Jack position points.

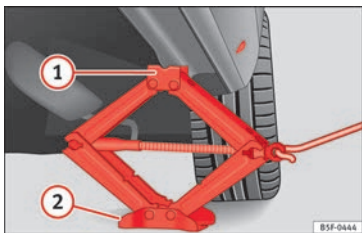

Fig. 86 Fitting the jack.

• Place the jack* (vehicle tools) on firm ground. If necessary use a large, strong board or similar support. If the surface is slippery (for example tiles) place the jack on a rubber mat or similar to prevent it from slipping » » » ⚠.

• Find the support point on the strut (sunken area) closest to the wheel to be changed » » » Fig. 85.

• Turn the jack* crank handle, located below the strut support point, to raise it until the tab ① » » » Fig. 86 is below the housing provided.

• Align the jack* so that tab ① “grips” onto the housing provided on the strut and the mobile base ② is resting on the ground. The base plate ② should fall vertically with respect to the support point ①.

• Continue turning the jack* until the wheel is slightly lifted off the ground.

⚠ WARNING

• Make sure that the jack* remains stable. If the surface is slippery or soft, the jack* could slip or sink, respectively, with the resultant risk of injury.

• Only raise the vehicle with the jack* supplied by the manufacturer. Other vehicles could slip, with the consequent risk of injury.

• Only mount the jack* on the support points designed for this purpose on the strut, and always align the jack correctly. If you do not, the jack* could slip as it does not have an adequate grip on the vehicle: risk of injury!

• The height of the parked vehicle can change as a result of variations in temperature and loading.

ⓘ CAUTION

The vehicle must not be raised on the cross-bar. Only place the jack* on the points designed for this purpose on the strut. Otherwise, the vehicle may be damaged.

Removing and fitting the wheel

Change the wheel after loosening the wheel bolts and raising the vehicle with the jack.

Taking off the wheel

- Unscrew the wheel bolts using the box spanner and place them on a clean surface.
- Take off the wheel » » » ⓘ.

Putting on the spare wheel

When fitting tyres with a compulsory rotation direction, observe the instructions in » » » page 69.

- Mount the wheel.
- Screw on the wheel bolts in position and tighten them loosely with a box spanner.
- Carefully lower the vehicle using the jack*.
- Tighten the wheel bolts in diagonal pairs using the wheel brace.

The wheel bolts should be clean and turn easily. Before fitting the spare wheel, inspect

the wheel condition and hub mounting surfaces. These surfaces must be clean before fitting the wheel.

Wheel bolt tightening torque

The prescribed tightening torque for wheel bolts for steel and alloy wheels is **120 Nm**. After changing a wheel, have the tightening torque checked immediately with a torque wrench that is working perfectly.

Before checking tightening torque, have any rusty wheel bolts that are difficult to screw replaced and clean the wheel hub threads.

Never apply grease or oil to wheel bolts or to the wheel hub threads. Even if the bolts have been tightened to the prescribed torque, they could come loose while driving.

WARNING

If the wheel bolts are not properly tightened, they could come loose while driving and cause an accident, serious injury and loss of vehicle control.

- Use only wheel bolts which correspond to the rim in question.
- Never use different wheel bolts.
- Wheel bolts and threads should be clean, free of oil and grease, and it should be possible to screw them easily.
- To loosen and tighten wheel bolts, only use the wheel wrench that came with the car from the factory.

- **Loosen the wheel bolts only about one turn before raising the vehicle with the jack.**
- **Never apply grease or oil to wheel bolts or to the wheel hub threads. Even if the bolts have been tightened to the prescribed torque, they could come loose while driving.**
- **Never loosen the screwed joints of wheel rims with bolted ring trims.**
- **If wheel bolts are tightened below the prescribed torque, the bolts and rims could come loose while driving. If tightening torque is too high, the wheel bolts or threads can be damaged.**

CAUTION

When removing/fitting the wheel, the rim may hit and damage the brake disc. For this reason, please take care and get a second person to assist you.

Tyres with compulsory direction of rotation



A directional tread pattern can be identified by the arrows on the sidewall that point in the direction of rotation. Always observe the direction of rotation indicated when fitting the wheel to guarantee optimum properties of this type of tyres with regard to grip, noises, wear and aquaplaning.

If it is absolutely necessary to fit the spare tyre* against the direction of rotation, drive

with care as this means the tyre does not offer optimum driving properties. This is of particular importance when the road surface is wet.

To return to directional tread tires, replace the punctured tyre as soon as possible and restore the obligatory direction of rotation of all tyres.

Subsequent work

- *Alloy wheels:* replace the wheel bolt caps.
- *Plate wheels:* replace the wheel hubcap.
- Return all tools to their proper storing location.
- If the replaced wheel does not fit in the spare wheel housing, store it safely in the luggage compartment  [page 160](#).
- Check the tyre pressure of the newly mounted tyre as soon as possible.
- In vehicles fitted with a tyre pressure indicator, adjust the pressure and store it in memory  [page 278](#).
- Have the tightening torque of the wheel bolts checked as soon as possible with a torque wrench (it should be 120 Nm). Meanwhile, drive carefully.
- Have the flat tyre replaced as quickly as possible.

Snow chains

Use

Snow chains should only be used on the front wheels.

- Check that they are correctly seated after driving for a few yards; correct the position if necessary, in accordance with the manufacturer's fitting instructions.
- Keep your speed below 50 km/h (30 mph).
- If there is a danger of being trapped despite having mounted the chains, it is best to disable the driving wheels (ASR) in the ESC **»»**  **page 183.**

Snow chains will improve *braking ability* as well as *traction* in winter conditions.

For technical reasons snow chains may only be used with the following wheel rim/tyre combination.

185/70 R14	Chains with links of maximum 13.5 mm
185/65 R15	Chains with links of maximum 13.5 mm
195/55 R16	Chains with links of maximum 9 mm

Remove wheel covers and any integral trim ring before fitting snow chains.

Remove the chains when roads are free of snow. Driving characteristics worsen, and the wheels become damaged quickly and may even be rendered unusable.

WARNING

Snow chains should be correctly tightened in accordance with the manufacturer's instructions. This will prevent the chains coming into contact with the wheel housing.

Emergency towing of the vehicle

Towing



Fig. 87 Right side of the front bumper: Towing ring.



Fig. 88 Right side of the rear bumper: Towing ring.

Towline anchorages

Attach the bar or rope to the towline anchorages.

The towline anchorages are located under the floor panel in the luggage compartment, next to the vehicle tools **»»** **page 65.**

Screw the towline anchorage into the screw connection **»»** **Fig. 87** or **»»** **Fig. 88** and tighten it with the wheel brace.

Tow rope or tow bar

It is easier and safer for the vehicle to be towed using a tow bar. You should only use a tow-rope if you do not have a tow-bar.

A tow rope should be slightly elastic to reduce the loading on both vehicles. It is advisable to use a tow rope made of synthetic fibre or similarly elastic material.

Attach the tow rope or the tow bar only to the towline anchorages provided or a towing bracket.

Notes for the driver of the towing vehicle

- The tow rope must be taut before you drive off.
- Release the clutch very carefully when starting the vehicle (manual gearbox), or accelerate gently (automatic gearbox).

Driving style

Towing requires some experience, especially when using a *tow rope*. Both drivers should realise how difficult it is to tow a vehicle. Inexperienced drivers should not attempt to tow.

Do not pull too hard with the towing vehicle and take care to avoid jerking the tow rope. When towing on an unpaved road, there is always a risk of overloading and damaging the anchorage points.

The ignition of the vehicle being towed must be switched on to prevent the steering wheel from locking and also to allow the use of the turn signals, horn, windscreen wipers and washers.

Place the gear lever in neutral on vehicles with a manual gearbox. With an automatic gearbox, place the lever in **N**.

The brake servo only works when the engine is running. When not running, you must apply considerably more pressure to the brake pedal.

As the power assisted steering does not work if the engine is not running, you will need more strength to steer than you normally would.



» » ⚠ in General information on page 100



» » page 100



» » ⚠ in General information on page 100



» » page 100

Tow-starting

If the engine will not start, first try starting it using the battery of another vehicle

» » **page 71**. You should only attempt to tow-start a vehicle if charging the battery does not work. This is done by leveraging wheel movement.

When tow-starting a vehicle with a **petrol engine**, do not tow it more than a *short* distance, otherwise unburned fuel can enter the catalytic converter.

However, if your vehicle has to be tow-started:

- Engage 2nd or 3rd gear.
- Keep the clutch pressed down.

- Switch the ignition on.
- Once both vehicles are moving, release the clutch.
- As soon as the engine starts, press the clutch and move the gear lever into neutral. This helps to prevent driving into the towing vehicle.

How to jump start

Jump leads

The jump lead must have a sufficient wire cross section.

If the engine fails to start because of a discharged battery, the battery can be connected to the battery of another vehicle to start the engine.

Jump leads

Jump leads must comply with standard **DIN 72553** (see cable manufacturer's instructions). The wire cross section must be at least 25 mm² for petrol engines and at least 35 mm² for diesel engines.



Note

- The vehicles must not touch each other, otherwise electricity could flow as soon as the positive terminals are connected.
- The discharged battery must be properly connected to the on-board network.

How to jump start: description

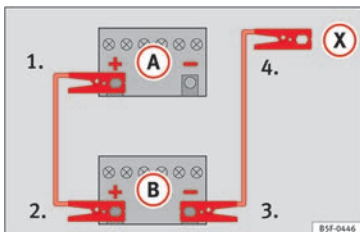

Fig. 89 Diagram of connections for vehicles without Start-Stop system.

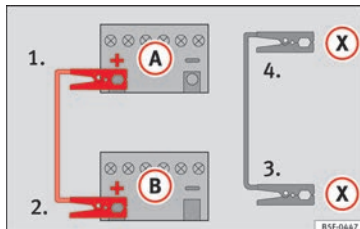

Fig. 90 Diagram of connections for vehicles with Start-Stop system.

Jump lead terminal connections

1. Switch off the ignition of both vehicles » **⚠**.
2. Connect one end of the *red* jump lead to the positive (+) terminal of the vehicle with the flat battery **(A)** » **Fig. 89**.
3. Connect the other end of the *red* jump lead to the positive terminal (+) in the vehicle providing assistance **(B)**.
- 4a. *For vehicles without Start-Stop system:* connect one end of the *black* jump lead to the negative terminal (-) of the vehicle providing the current **(B)** » **Fig. 89**.
- 4b. *For vehicles with Start-Stop system:* connect one end of the *black* jump lead **(X)** to a suitable ground terminal, to a solid piece of metal in the engine block, or to the engine block itself » **Fig. 90**.

7. Connect the other end of the *black* jump lead **(X)** to a solid metal component bolted to the engine block or to the engine block itself of the vehicle with the flat battery. Do not connect it to a point near the battery **(A)**.
6. Position the leads in such a way that they cannot come into contact with any moving parts in the engine compartment.

Starting

7. Start the engine of the vehicle with the boosting battery and let it run at idling speed.
8. Start the engine of the vehicle with the flat battery and wait for 2 or 3 minutes until the engine is running.

Removing the jump leads

9. Before you remove the jump leads, switch off the dipped beam headlights if they are switched on.
10. Turn on the heater blower and heated rear window in the vehicle with the flat battery. This helps minimise voltage peaks which are generated when the leads are disconnected.
11. When the engine is running, disconnect the leads in reverse order to the details given above.

Make sure the battery clamps have sufficient metal-to-metal contact with the battery terminals.

If the engine fails to start after about 10 seconds, switch off the starter and try again after about 1 minute.

⚠ WARNING

- Please note the safety warnings referring to working in the engine compartment
»  page 263, Working in the engine compartment.
- The battery providing assistance must have the same voltage as the flat battery (12 V) and approximately the same capacity (see imprint on battery). Failure to comply could result in an explosion.
- Never use jump leads when one of the batteries is frozen. Danger of explosion! Even after the battery has thawed, battery acid could leak and cause chemical burns. If a battery freezes, it should be replaced.
- Keep sparks, flames and lighted cigarettes away from batteries, danger of explosion. Failure to comply could result in an explosion.
- Observe the instructions provided by the manufacturer of the jump leads.
- Do not connect the negative cable from the other vehicle directly to the negative terminal of the flat battery. The gas emitted from the battery could be ignited by sparks. Danger of explosion.

- Never attach the negative cable to fuel system components or the brake lines in the other vehicle.
- The non-insulated parts of the battery clamps must not be allowed to touch. The jump lead attached to the positive battery terminal must not touch metal parts of the vehicle, this can cause a short circuit.
- Position the leads in such a way that they cannot come into contact with any moving parts in the engine compartment.
- Do not lean on the batteries. This could result in chemical burns.

Note

The vehicles must not touch each other, otherwise electricity could flow as soon as the positive terminals are connected.

Changing the windscreen wiper blades

Changing the wiper blades

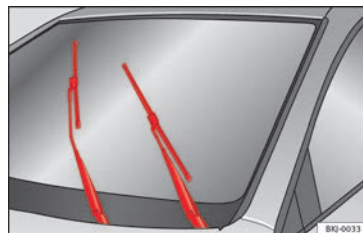

Fig. 91 Wipers in service position.

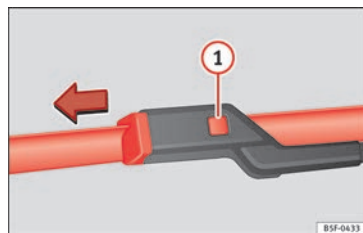

Fig. 92 Changing the windscreen wiper blade.

To change the blades it is necessary to move the wipers from the rest position into the service position. »

Do not change the windscreen wipers when out of the service position, as it could cause paint to flake off the bonnet due to friction with the windscreen wiper arm.

Service position (for changing wiper blades)

- Ensure that the wiper blades are not frozen.
- Turn the ignition on and off and then (with-in approximately 9 seconds) push the windscreen wiper lever down (short wipe). The windscreen wipers will move to the service position » **Fig. 91.**

Removing the wiper blade

- Lift the windscreen wiper arm.
- Press the securing tab down ① » **Fig. 92.**
- Extract the wiper blade from the wiper arm.

Fitting the wiper blade

- Insert the wiper blade onto the windscreen wiper arm until it clicks into place.
- Place the windscreen wiper arms to their initial position.
- Turn the ignition on, push the windscreen wiper lever down (touch wipe) and then turn the ignition off.



» ⚠ in Changing the windscreen and rear window wiper blades on page 100



» page 100

Changing the rear window wiper blade

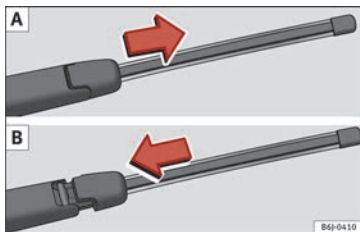

Fig. 93 Removing and fitting the rear window wiper blade.

Removing the wiper blade

- Lift the wiper arm away from the glass
- Slide the blade adapter in the direction of the arrow and remove the blade » **Fig. 93 A.**

Fitting the wiper blade

- With one hand, hold the top end of the wiper arm.
- Place the blade as shown in » **Fig. 93 B** and slide the adapter along until it engages.



» ⚠ in Changing the windscreen and rear window wiper blades on page 100



» page 100

Safety

Safe driving

Safety first!

This chapter contains important information, tips, suggestions and warnings that you should read and consider for both your own safety and for your passengers' safety.

WARNING

- This manual contains important information about the operation of the vehicle, both for the driver and the passengers. The other sections of the on-board documentation also contain further information that you should be aware of for your own safety and for the safety of your passengers.
- Ensure that the on-board documentation is kept in the vehicle at all times. This is especially important when lending or selling the vehicle to another person.

Advice about driving

Before setting off

For your own safety and the safety of your passengers, always note the following points before every trip:

- Make sure that the vehicle's lights and turn signals are working properly.
- Check tyre pressure.
- Ensure that all windows provide a clear and good view of the surroundings.
- Ensure that all luggage is correctly secured **»» page 160**.
- Make sure that no objects can interfere with the pedals.
- Adjust front seat, head restraint and mirrors properly according to your size.
- Ensure that the passenger in the central rear seat always has the head restraint in the correct position for use.
- Instruct passengers to adjust the head restraints according to their height.
- Protect children with appropriate child seats and properly applied seat belts **»» page 92**.
- Assume the correct sitting position. Instruct your passengers also to assume a proper sitting position **»» page 76**.
- Fasten your seat belt securely. Instruct your passengers also to fasten their seat belts properly **»» page 81**.

What affects driving safety?

As a driver, you are responsible for yourself and your passengers. When your concentration or driving safety is affected by any circumstance, you endanger yourself as well as others on the road **»» **, for this reason:

- Always pay attention to traffic and do not get distracted by passengers or telephone calls.
- Never drive when your driving ability is impaired (e.g. by medication, alcohol, drugs).
- Observe traffic laws and speed limits.
- Always reduce your speed as appropriate for road, traffic and weather conditions.
- When travelling long distances, take breaks regularly - at least every two hours.
- If possible, avoid driving when you are tired or stressed.

WARNING

When driving safety is impaired during a trip, the risk of injury and accidents increases.

Safety equipment

Never put your safety or the safety of your passengers in danger. In the event of an accident, the safety equipment may reduce the **»»**

risk of injury. The following points cover part of the safety equipment in your SEAT¹⁾:

- three-point seat belts,
- Belt tension limiter for the front and rear side seats
- belt tensioners for the front and rear seats,
- front airbags,
- side airbags in the front seat backrests,
- “ISOFIX” anchor points for “ISOFIX” rear child seat system
- height-adjustable front head restraints,
- Rear-centre head restraints with in-use position and non-use position
- adjustable steering column.

The safety equipment mentioned above works together to provide you and your passengers with the best possible protection in the event of an accident. However, these safety systems can only be effective if you and your passengers are sitting in a correct position and use this equipment properly.

Safety is everyone's business!

Correct position of the vehicle occupants

Correct sitting position for the driver

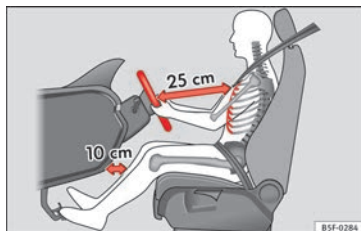

Fig. 94 The proper distance between driver and steering wheel.

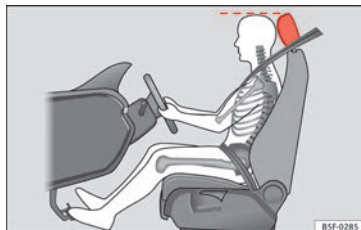

Fig. 95 Correct head restraint position for the driver.

For your own safety and to reduce the risk of injury in the event of an accident, we recommend the following adjustments for the driver:

- Adjust the steering wheel so that there is a distance of at least 25 cm between the steering wheel and the centre of your chest ►► **Fig. 94.**
 - Move the driver's seat forwards or backwards so that you are able to press the accelerator, brake and clutch pedals to the floor with your knees still slightly angled ►► **△.**
 - Ensure that you can reach the highest point of the steering wheel.
 - Adjust the head restraint so that its upper edge is at the same level as the top of your head, or as close as possible to the same level as the top of your head ►► **Fig. 95.**
 - Move the seat backrest to an upright position so that your back rests completely against it.
 - Fasten your seat belt securely ►► **page 81.**
 - Keep both feet in the footwell so that you have the vehicle under control at all times.
- Adjustment of the driver's seat ►► **page 154.**

¹⁾ Depending on the version/market.

⚠ WARNING

- An incorrect sitting position of the driver can lead to severe injuries.
- Adjust the driver's seat so that there is at least 25 cm distance between the centre of the chest and the centre of the steering wheel » Fig. 94. If distance is less than 25 cm, the airbag system may not protect you properly.
- If your physical constitution prevents you from maintaining the minimum distance of 25 cm, contact a specialised workshop. The workshop will help you decide if special specific modifications are necessary.
- When driving, always hold the steering wheel with both hands on the outside of the ring at the 9 o'clock and 3 o'clock positions. This reduces the risk of injury when the driver airbag is triggered.
- Never hold the steering wheel at the 12 o'clock position, or in any other manner (e.g. in the centre of the steering wheel). In such cases, if the airbag is triggered, you may sustain injuries to the arms, hands and head.
- To reduce the risk of injury to the driver during sudden braking manoeuvres or an accident, never drive with the backrest tilted far back! The airbag system and seat belts can only provide optimal protection when the backrest is in an upright position and the driver is wearing his or her seat belt correctly.
- Adjust the head restraint properly to achieve optimal protection.

Adjusting the steering wheel position

Read the additional information carefully
»  page 20

⚠ WARNING

- Never adjust the position of the steering wheel when the vehicle is moving, as this could cause an accident.
- Move the lever up firmly so the steering wheel position does not accidentally change during driving. risk of accident!
- Make sure you are capable of reaching and firmly holding the upper part of the steering wheel: risk of accident!
- If you adjust the steering wheel so that it points towards your face, the driver airbag will not protect you properly in the event of an accident. Make sure that the steering wheel points towards your chest.

Correct position for the front passenger

For your own safety and to reduce the risk of injury in the event of an accident, we recommend the following adjustments for the front passenger:

- Move the front passenger seat back as far as possible » .

- Move the seat backrest to an upright position so that your back rests completely against it.
- Adjust the head restraint so that its upper edge is at the same level as the top of your head, or as close as possible to the same level as the top of your head » page 79.
- Always keep both feet in the footwell in front of the front passenger seat.
- Fasten your seat belt securely » page 81.

It is possible to deactivate the front passenger airbag in **exceptional circumstances** » page 90.

Adjusting the front passenger seat
»  page 19.

⚠ WARNING

- An incorrect sitting position of the front passenger can lead to severe injuries.
- Adjust the front passenger seat so that there is at least 25 cm between your chest and the dash panel. If distance is less than 25 cm, the airbag system may not protect you properly.
- If your physical constitution prevents you from maintaining the minimum distance of 25 cm, contact a specialised workshop. The workshop will help you decide if special specific modifications are necessary.

»

- Always keep your feet in the footwell when the vehicle is moving; never rest them on the dash panel, out the window or on the seat. An incorrect sitting position exposes you to an increased risk of injury in case of a sudden braking or an accident. If the airbag is triggered, you could sustain severe injuries due to an incorrect sitting position.

- To reduce the risk of injury to the front passenger in events such as sudden braking manoeuvres or an accident, never travel with the backrest tilted far back! The airbag system and seat belts can only provide optimal protection when the backrest is in an upright position and the front passenger is wearing his or her seat belt properly. The further the seat backrests are tilted to the rear, the greater the risk of injury due to incorrect positioning of the belt web or to the incorrect sitting position!

- Adjust the head restraint correctly in order to achieve maximum protection.

Correct sitting position for rear seat passengers

To reduce the risk of injury in the event of a sudden braking manoeuvre or an accident, passengers on the rear seat bench must consider the following:

- Sit up straight.
- Adjust the head restraint to the correct position » page 79.

- Always keep both feet in the footwell in front of the rear seat.
- Fasten your seat belt securely » page 81.
- Use an appropriate child restraint system when you take children in the vehicle » page 92.

WARNING

- If the passengers in the rear seats are not sitting properly, they could sustain severe injuries.
- Adjust the head restraint correctly in order to achieve maximum protection.
- Seat belts can only provide optimal protection when seat backrests are in an upright position and the vehicle occupants are wearing their seat belts correctly. If passengers in the rear seats are not sitting in an upright position, the risk of injury due to incorrect positioning of the seat belt increases.

Examples of incorrect sitting positions

Seat belts can provide optimal protection only when the belt webs are properly positioned. Incorrect sitting positions substantially reduce the protective function of seat belts and increase the risk of injury due to incorrect seat belt position. As the driver, you are responsible for all passengers, especially children.

- Never allow anyone to assume an incorrect sitting position in the vehicle while travelling » .

The following list contains examples of sitting positions that could be dangerous for all vehicle occupants. The list is not complete, but we would like to make you aware of this issue.

Therefore, whenever the vehicle is in motion:

- Never stand in the vehicle.
- Never stand on the seats.
- Never kneel on the seats.
- Never tilt your seat backrest far to the rear.
- Never lean against the dash panel.
- Never lie on the rear bench.
- Never sit on the front edge of a seat.
- Never sit sideways.
- Never lean out of a window.
- Never put your feet out of a window.
- Never put your feet on the dash panel.
- Never put your feet on the surface of a seat.
- Do not allow anyone to travel in the footwell.
- Never travel without wearing the seat belt.
- Do not allow anyone to travel in the luggage compartment.

⚠ WARNING

- Any incorrect sitting position increases the risk of severe injuries.
- Sitting in an incorrect position exposes the vehicle occupants to severe injuries if airbags are triggered, by striking a vehicle occupant who has assumed an incorrect sitting position.
- Before the vehicle moves, assume the proper sitting position and maintain it throughout the trip. Before every trip, instruct your passengers to sit properly and to stay in this position during the trip » page 76, Correct position of the vehicle occupants.

Correct adjustment of front head restraints

Fig. 96 Correctly adjusted head restraint as viewed from the front and the side.

Properly adjusted head restraints are an important part of passenger protection and can reduce the risk of injuries in most accident situations.

- Adjust the head restraint so that its upper edge is, as far as possible, at the same level as the top of your head, or at the very least, at eye level » **Fig. 96.**

⚠ WARNING

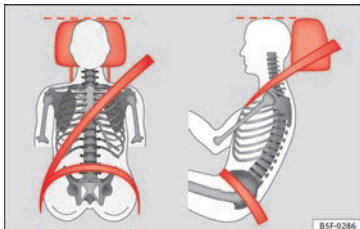
- Travelling with the head restraints removed or improperly adjusted increases the risk of severe injuries. An improper adjustment of the head restraints may cause death in an accident and increase the risk of suffering injuries during abrupt braking actions or unexpected manoeuvres.
- The head restraints must always be adjusted according to the height of the passenger.

Correct adjustment of rear head restraints

Fig. 97 Head restraints in the correct position.



Fig. 98 Head restraint position warning label.

Properly adjusted head restraints are an important part of the passenger protection and can reduce the risk of injuries in most accident situations

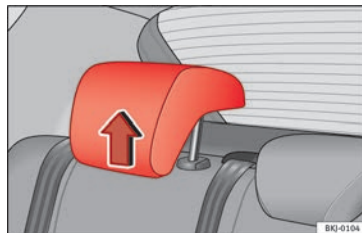
Rear head restraints

- The rear head restraints have 2 positions: **use** and **non-use**.
- One position for **use** (head restraint raised)
 - » **Fig. 97**. In this position, the head restraints are used normally, protecting passengers along with the rear seat belts.
- And one position for **non-use** (head restraint lowered).
- To fit the head restraints in position for use, pull on the edges with both hands in the direction of the arrow.

WARNING

- **Under no circumstances should the rear passengers travel while the head restraints are in the non-use position. See the warning label located on the rear side fixed window » Fig. 98.**
- **Do not swap the centre rear head restraint with either of the outer seat rear head restraints. Risk of injury in case of an accident!**

CAUTION

Note the instructions on the adjustment of the head restraints » page 154.

Pedal area

Pedals

- Ensure that you can always press the accelerator, brake and clutch pedals unimpaired to the floor.
- Ensure that the pedals can return unimpaired to their initial positions.
- Ensure that the floor mats are securely fastened during the trip and do not obstruct the pedals » .

Only use floor mats which leave the pedals clear and which are secured to prevent them from slipping. You can obtain suitable floor mats from a specialised dealership.

If a brake circuit fails, the brake pedal must be pressed down thoroughly in order to stop the vehicle.

Wear suitable footwear

Always wear shoes which support your feet properly and give you a good feeling for the pedals.

WARNING

- **If the pedals are obstructed, an accident may occur. Risk of serious injuries.**
- **Never lay or fit floor mats or other floor coverings over the original floor mats. This**

would reduce the pedal area and could obstruct the pedals. Risk of accident.

- **Never place objects in the driver footwell. An object could move into the pedal area and impair pedal operation. In the event of a sudden driving or braking manoeuvre, you will not be able to operate the brake, clutch or accelerator pedal. Risk of accident!**

Seat belts

Why wear a seat belt

Number of seats

Your vehicle has **five** seats, two in the front and three in the rear. Each seat is equipped with a three-point seat belt.

WARNING

- Never transport more than the permitted amount of people in your vehicle.
- Every vehicle occupant must properly fasten and wear the seat belt belonging to his or her seat. Children must be protected with an appropriate child restraint system.

Seat belt control lamp*



Fig. 99 Instrument panel: right rear seat occupied and corresponding seat belt fastened display.

The control lamp illuminates to remind the driver to fasten his seat belt.

Before starting the vehicle:

- Fasten your seat belt securely.
- Instruct your passengers to fasten their seat belts properly before driving off.
- Protect children by using a child seat according to the child's height and weight.



When the ignition is switched on, the control lamp  in the instrument panel lights up (depending on the model version) if the driver or passenger have not fastened their seat belts.

When starting to drive, if the vehicle's speed surpasses approx. 25 km/h (15 mph) and the seat belts are not fastened or are unfastened

during the drive, a warning sound will be heard for a few seconds. The warning light will also flash .

The lamp  goes out when the driver and passenger seat belts are fastened with the ignition switched on.

Rear seat belts fastened display*

Depending on the model version, when the ignition is switched on, the seat belt status display  **Fig. 99** on the instrument panel informs the driver whether the passengers in the rear seats have fastened their seat belts. The  symbol indicates that the passenger in this seat has fastened "his or her" seat belt.

When a seat belt in the rear seats is fastened or unfastened, the seat belt status is displayed for approximately 30 seconds. The indication can be hidden by pressing the **[0.0/SET]** button on the dash panel.

The seat belt status flashes for a maximum of 30 seconds when a seat belt in the rear seats is unfastened while the vehicle is in motion. An audible warning will also be heard if the vehicle is travelling at over 25 km/h (15 mph).

The protective function of seat belts



Fig. 100 Drivers with properly worn seat belts will not be thrown forward in the event of sudden braking.

Properly worn seat belts hold the occupants in the proper position. These also help prevent uncontrolled movements that may result in serious injury and reduce the risk of being thrown out of the vehicle.

Vehicle occupants wearing their seat belts correctly benefit greatly from the ability of the belts to absorb kinetic energy. In addition, the front part of your vehicle and other passive safety features (such as the airbag system) are designed to absorb the kinetic energy released in a collision. Taken together, all these features reduce the releasing kinetic energy and consequently, the risk of injury. This is why it is so important to fasten seat belts before every trip, even when "just driving around the corner".

Ensure that your passengers wear their seat belts as well. Accident statistics have shown that wearing seat belts is an effective means of substantially reducing the risk of injury and improving the chances of survival when involved in a serious accident. Furthermore, properly worn seat belts improve the protection provided by airbags in the event of an accident. For this reason, wearing a seat belt is required by law in most countries.

Although your vehicle is equipped with airbags, the seat belts must be fastened and worn. The front airbags, for example, are only triggered in some cases of head-on collision. The front airbags will not be triggered during minor frontal or side collisions, rear-end collisions, rollovers or accidents in which the airbag trigger threshold value in the control unit is not exceeded.

Therefore, you should always wear your seat belt and ensure that all vehicle occupants have fastened their seat belts properly before you drive off!

Important safety instructions for the use of seat belts

- Always wear the seat belt as described in this section.
- Ensure that the seat belts can be fastened at all times and are not damaged.

⚠ WARNING

- If seat belts are worn incorrectly or not at all, the risk of severe injuries increases. The optimal protection from seat belts can be achieved only if you use them properly.
- Fasten your seat belt before every trip - even when driving in town. Other vehicle occupants must also wear the seat belts at all times, otherwise they run the risk of being injured.
- The seat belt cannot offer its full protection if the seat belt is not positioned correctly.
- Never allow two passengers (even children) to share the same seat belt.
- Always keep both feet in the footwell in front of your seat as long as the vehicle is in motion.
- Never unbuckle a seat belt while the vehicle is in motion. Risk of fatal injury.
- The seat belt must never be twisted while it is being worn.
- The seat belt should never lie on hard or fragile objects (such as glasses or pens, etc.) because this can cause injuries.
- Do not allow the seat belt to be damaged or jammed, or to rub on any sharp edges.
- Never wear the seat belt under the arm or in any other incorrect position.
- Bulky and unfastened clothing (such as an overcoat over a sweater) impairs the proper fit and function of the seat belts, reducing their capacity to protect.

- The slot in the seat belt buckle must not be blocked with paper or other objects, as this can prevent the latch plate from engaging securely.
- Never use seat belt clips, fastening rings or similar items to alter the position of the belt webbing.
- Frayed or torn seat belts or damage to the connections, belt retractors or parts of the buckle could cause severe injuries in the event of an accident. Therefore, you must check the condition of all seat belts at regular intervals.
- Seat belts which have been worn in an accident and have been stretched must be replaced by a specialised workshop. Renewal may be necessary even if there is no apparent damage. The belt anchorage should also be checked.
- Do not attempt to repair a damaged seat belt yourself. The seat belts must not be removed or modified in any way.
- The belts must be kept clean, otherwise the retractors may not work properly.

Head-on collisions and the laws of physics



Fig. 101 A driver not wearing a seat belt is thrown forward violently.



Fig. 102 The unbelted passenger in the rear seat is thrown forward violently, hitting the driver who is wearing a seat belt.

It is easy to explain how the laws of physics work in the case of a head-on collision: when a vehicle starts moving, a type of energy

called “kinetic energy” is created both in the passengers and inside the vehicle.

The amount of “kinetic energy” depends on the speed of the vehicle and on the weight of the vehicle and of its passengers. The higher the speed and the greater the weight, the more energy there is to be “absorbed” in an accident.

The most significant factor, however, is the speed of the vehicle. If the speed doubles from 25 km/h (15 mph) to 50 km/h (30 mph), for example, the corresponding kinetic energy is multiplied by four.

Because the vehicle occupants in our example are not restrained by seat belts, in the event of crashing against a wall, all of the occupants' kinetic energy will be absorbed solely by said impact.

Even at speeds of 30 km/h (19 mph) to 50 km/h (30 mph), the forces acting on bodies in a collision can easily exceed one tonne (1000 kg). At greater speed these forces are even higher.

Vehicle occupants not wearing seat belts are not “attached” to the vehicle. In a head-on collision, they will move forward at the same speed their vehicle was travelling just before the impact. This example applies not only to head-on collisions, but to all accidents and collisions.

Even at low speeds the forces acting on the body in a collision are so great that it is not possible to brace oneself with one's hands. In a frontal collision, unbelted passengers are thrown forward and will make violent contact with the steering wheel, dash panel, windscreen or whatever else is in the way » **Fig. 101.**

It is also important for rear passengers to wear seat belts properly, as they could otherwise be thrown forward violently through the vehicle interior in an accident. Passengers in the rear seats who do not use seat belts endanger not only themselves but also the front occupants » **Fig. 102.**

How to properly adjust your seatbelt

Fastening and unfastening your seat belt

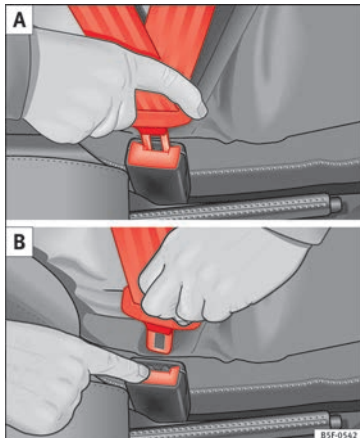

Fig. 103 Positioning and removing the seat belt buckle.



Fig. 104 Position of seat belt during pregnancy.

Read the additional information carefully »  page 19.

Fasten your seat belt

The seat belt cannot offer its full protection if the seat belt is not positioned correctly.

- Adjust the seat and head restraint correctly.
- To fasten the belt, take hold of the latch plate and pull it slowly across your chest and lap.
- Insert the latch plate into the buckle for the appropriate seat and push it down until it is securely locked with an audible click » **Fig. 103.**
- Pull the belt to ensure that the latch plate is securely engaged in the buckle.

The seat belts are equipped with an automatic retractor on the shoulder strap. Full freedom of movement is permitted when the shoulder belt is pulled slowly. However, during sudden braking, during travel in steep areas or bends and during acceleration, the automatic retractor on the shoulder belt is locked.

The automatic belt retractors on the front seats are fitted with seat belt tensioners »» page 85.

Releasing the seat belt

- Press the red button on the belt buckle »» Fig. 103. The latch plate is released and springs out »» .
- Guide the belt back by hand so that it rolls up easily and the trim is not damaged.

Positioning seat belts

Seat belts offer their maximum protection only when they are properly positioned.

WARNING

- The seat belts offer best protection only when the backrests are in an upright position and the seat belts have been fastened properly.
- Never put the latch plate in the buckle of another seat. If you do this, the seat belt will not protect you properly and the risk of injury is increased.

- **Never unbuckle a seat belt while the vehicle is in motion. If you do, you increase the risk of sustaining severe or fatal injuries.**
- **An incorrectly worn seat belt can cause severe injuries in the event of an accident.**
- **The shoulder part of the seat belt must lie on the centre of the shoulder, never across the neck. The seat belt must lie flat and fit comfortably on the torso**
- **The lap part of the seat belt must lie across the pelvis, never across the stomach. The seat belt must lie flat and fit comfortably on the pelvis Pull the belt tight if necessary to take up any slack.**
- **For pregnant women, the lap part of the seat belt must lie as low as possible over the pelvis, never across the stomach, and always lie flat so that no pressure is exerted on the abdomen »» Fig. 104.**
- **Always engage the retractor lock when you are securing a child seat in group 0, 0+ or 1 »» page 92.**
- **Read and observe the warnings »» page 82.**

Seat belt tensioners*

Seat belt tensioner operation

Read the additional information carefully

»»  page 20

The seat belts for the front and side rear occupants are equipped with belt tensioners. The belt tensioners are activated by sensors, although only in severe head-on and lateral collisions. This retracts and tightens the seat belts, reducing the forward motion of the occupants.

The belt tensioners will not be triggered in the event of minor collisions, if the vehicle overturns, or in accidents where no major forces act on the vehicle.

Note

- **If the seat belt tensioners are triggered, a fine dust is produced. This is normal and it is not an indication of fire in the vehicle.**
- **The relevant safety requirements must be observed when the vehicle or components of the system are scrapped. Specialised workshops are familiar with these regulations, which are also available to you.**

Maintenance and disposal of belt tensioners

The belt tensioners are components of the seat belts that are installed in the seats of your vehicle. If you work on the belt tensioners or remove and install parts of the system when performing other repair work, the seat belt may be damaged. The consequence may be that, in the event of an accident, the belt »»

tensioners function incorrectly or may not function at all.

So that the effectiveness of the seat belt tensioner is not reduced and that removed parts do not cause any injuries or environmental pollution, regulations, which are known to the specialised workshops, must be observed.

WARNING

- **Improper use or repairs not carried out by qualified mechanics increase the risk of severe or fatal injuries. The belt tensioners may fail to trigger or may trigger in the wrong circumstances.**
- **Never attempt to repair, adjust, remove or install parts of the belt tensioners or seat belts.**
- **The seat belt tensioner, seat belt and automatic retractor cannot be repaired.**
- **Any work on the belt tensioners and seat belts, including the removal and refitting of system parts in conjunction with other repair work, must be performed by a specialised workshop only.**
- **The belt tensioners will only provide protection for one accident and must be changed if they have been activated.**

Airbag system

Brief introduction

Why is it so important to wear a seat belt and to sit correctly?

For the inflating airbags to achieve the best protection, the seat belt must always be worn properly and the correct sitting position must be assumed.

The airbag system is not a substitute for seat belts, but it is an integral part of the vehicle's overall passive safety system. Please bear in mind that the airbag system can only work effectively when the vehicle occupants are wearing their seat belts correctly and have adjusted the head restraints properly. Therefore, it is most important to properly wear the seat belts at all times, not only because this is required by law in most countries, but also for your safety »» page 81, **Why wear a seat belt.**

The airbag inflates in a matter of seconds, so if you are not properly seated when the airbag is triggered, you may sustain fatal injuries. Therefore, it is essential that all vehicle occupants assume a correct sitting position while travelling.

Sharp braking before an accident may cause a passenger not wearing a seat belt to be thrown forward into the area of the deploying

airbag. In this case, the inflating airbag may inflict critical or fatal injuries on the occupant. This also applies to children.

Always maintain the greatest possible distance between yourself and the front airbag. This way, the front airbags can completely deploy when triggered, providing their maximum protection.

The most important factors that will trigger an airbag are: the type of accident, the angle of collision and the speed of the vehicle.

Whether or not the airbags are triggered depends primarily on the vehicle deceleration rate resulting from the collision and detected by the control unit. If the vehicle deceleration occurring during the collision and measured by the control unit remains below the specified reference values, the front, side and/or curtain airbags will not be triggered. Take into account that the visible damage in a vehicle involved in an accident, no matter how serious, is not a determining factor for the airbags to have been triggered.

WARNING

- **Wearing the seat belt incorrectly or assuming an incorrect sitting position can lead to critical or fatal injuries.**
- **All vehicle occupants, including children, who are not properly belted can sustain critical or fatal injuries if the airbag is triggered. Children up to 12 years old should always**

travel on the rear seat. Never transport children in the vehicle if they are not restrained or the restraint system is not appropriate for their age, size or weight.

- If you are not wearing a seat belt, or if you lean forward or to the side while travelling or assume an incorrect sitting position, there is a substantially increased risk of injury. This increased risk of injury will be further increased if you are struck by an inflating air-bag.
- To reduce the risk of injury from an inflating airbag, always wear the seat belt properly.
- Always adjust the front seats properly.

Description of airbag system

Read the additional information carefully
»  page 21.

The airbag system is not a substitute for the seat belts. The airbag system offers additional protection for the driver and passenger in combination with the seat belts.

The airbag system mainly comprises (as per vehicle equipment):

- an electronic control and monitoring system (control unit)
- frontal airbags for driver and passenger,
- side airbags,
- curtain airbags,

- a control lamp  on the dash panel
» page 91.
- key-operated switch for front passenger airbag,
- a control lamp for disabling/enabling the front passenger airbag.

The airbag system operation is monitored electronically. The airbag control lamp will illuminate for a few seconds every time the ignition is switched on (self-diagnosis).

There is a fault in the system if the control lamp :

- does not light up when the ignition is switched on » page 91,
- turns off after 4 seconds after the ignition is switched on,
- turns off and then lights up again after the ignition is switched on,
- illuminates or flashes while the vehicle is moving.

The airbag system is not triggered if:

- the ignition is switched off
- there is a minor frontal collision
- there is a minor side collision
- there is a rear-end collision
- the vehicle turns over.

WARNING

- The seat belts and airbags can only provide maximum protection if the occupants are seated correctly » page 76, Correct position of the vehicle occupants.
- If a fault has occurred in the airbag system, have the system checked immediately by a specialised workshop. Otherwise, during a frontal collision the system might not trigger correctly or may fail to trigger at all.

Airbag activation

The airbags deploy extremely rapidly, within thousandths of a second, to provide additional protection in the event of an accident. A fine dust may develop when the airbag deploys. This is normal and it is not an indication of fire in the vehicle.

The airbag system is only ready to function when the ignition is on.

In special accidents instances, several airbags may activate at the same time.

In the event of minor head-on and side collisions, rear-end collisions, overturning or roll-over of the vehicle, airbags **do not activate**.

Activation factors

The conditions that lead to the airbag system activating in each situation cannot be generalised. Some factors play an important role, »

such as the properties of the object the vehicle hits (hard/soft), angle of impact, vehicle speed, etc.

Deceleration trajectory is key for airbag activation.

The control unit analyses the collision trajectory and activates the respective restraint system.

If the deceleration rate is below the predefined reference value in the control unit the airbags will not be triggered, even though the accident may cause extensive damage to the car.

The following airbags are triggered in serious head-on collisions:

- Driver airbag.
- Front passenger front airbag

The following airbags are triggered in serious side-on collisions:

- Front side airbag on the side of the accident.
- Curtain (head) airbag on the side of the accident.

In an accident with airbag activation:

- the interior lights switch on (if the interior light switch is in the courtesy light position);
- the hazard warning lights switch on;

- all doors are unlocked;
- the fuel supply to the engine is cut.

Airbag safety instructions

Front airbags

Read the additional information carefully »  page 21.

WARNING

- The seat belts and airbags can only provide maximum protection if the occupants are seated correctly » page 76, Correct position of the vehicle occupants.
- The deployment space between the front passengers and the airbags must not in any case be occupied by other passenger, pets and objects.
- The airbags provide protection for just one accident; replace them once they have deployed.
- It is also important not to attach any objects such as cup holders or telephone mountings to the surfaces covering the airbag units.
- Do not attempt to modify components of the airbag system in any way.

Side airbags*

Read the additional information carefully »  page 22.

WARNING

- If you do not wear a seat belt, if you lean forward, or are not seated correctly while the vehicle is in motion, you are at a greater risk of injury if the side airbag system is triggered in an accident.
- In order for the side airbags to provide their maximum protection, the prescribed sitting position must always be maintained with seat belts fastened while travelling.
- Occupants of the outer seats must never carry any objects or pets in the deployment space between them and the airbags, or allow children or other passengers to travel in this position. It is also important not to attach any accessories (such as cup holders) to the doors. This would impair the protection offered by the side airbags.
- The built-in coat hooks should be used only for lightweight clothing. Do not leave any heavy or sharp-edged objects in the pockets.
- Great forces, such as hard blows or kicks, must not be exerted upon the backrest bolster because the system may be damaged. In this case, the side airbags would not be triggered.
- Under no circumstances should protective covers be fitted over seats with side airbags

unless the covers have been approved for use in your vehicle. Because the airbag deploys from the side of the backrest, the use of conventional seat covers would obstruct the side airbag, seriously reducing the airbag's effectiveness.

- Any damage to the original seat upholstery or around the seams of the side airbag units must be repaired immediately by a specialised workshop.

- The airbags provide protection for just one accident; replace them once they have deployed.

- Any work on the side airbag system or removal and installation of the airbag components for other repairs (such as removal of the front seat) should only be performed by a specialised workshop. Otherwise, faults may occur during the airbag system operation.

- Do not attempt to modify components of the airbag system in any way.

- The side and head airbags are managed through sensors located in the interior of the front doors. To ensure the correct operation of the side and curtain (head) airbags neither the doors nor the door panels should be modified in any way (e.g. fitting loudspeakers). If the front door is damaged, the airbag system may not work correctly. All work carried out on the front door must be done in a specialised workshop.

- In a side-on collision the side airbags will not work if the sensors do not correctly measure the pressure increase on the interior of the doors, due to air escaping through the

areas with holes or openings in the door panel.

- Never drive if the interior door panels have been removed or if the panels have not been correctly fitted.

- Never drive the vehicle if the loudspeakers in the door panels have been removed, unless the holes left by the loudspeakers have been closed properly.

- Always check that the openings are closed or covered if additional loudspeakers or other equipment are fitted inside the door panels.

- Any work carried out to the doors should be made in an authorised specialised workshop.

Head-protection airbags*

Read the additional information carefully
»  page 23.

WARNING

- In order for the head-protection airbags to provide their maximum protection, the prescribed sitting position must always be maintained with seat belts fastened while travelling.

- For safety reasons, the curtain airbag must be disabled in those vehicles fitted with a screen dividing the interior of the vehicle. See your technical service to make this adjustment.

- There must be no other persons, animals or objects between the occupants of the outer seats and the deployment space of the head-protection airbags so that the head-protection airbag can deploy completely without restriction and provide the greatest possible protection. Therefore, sun blinds which have not been expressly approved for use in your vehicle may not be attached to the side windows

- The built-in coat hooks should be used only for lightweight clothing. Do not leave any heavy or sharp-edged objects in the pockets. Please, do not hang the clothes on coat hangers.

- The airbags provide protection for just one accident; replace them once they have deployed.

- Any work on the head-protection airbag system or removal and installation of the airbag components for other repairs (such as removal of the roof lining) should only be performed by a specialised workshop. Otherwise, faults may occur during the airbag system operation.

- Do not attempt to modify components of the airbag system in any way.

- The side and head airbags are managed through sensors located in the interior of the front doors. To ensure the correct operation of the side and curtain airbags neither the doors nor the door panels should be modified in any way (e.g. fitting loudspeakers). If the front door is damaged, the airbag system may not work correctly. All work carried out

on the front door must be done in a specialised workshop.

Deactivating airbags

Activation and deactivation of front passenger airbag*



Fig. 105 Switch for activating and deactivating the front passenger airbag.



Fig. 106 Centre side of dash panel: control lamp for deactivated front passenger airbag in centre console.

Deactivate the front passenger front airbag only if you have to use a rear-facing child seat in the front passenger seat.

SEAT recommends fitting the child seat in the rear seat to avoid having to deactivate the front passenger airbag.

Front passenger front airbag switch

When the front passenger airbag is **deactivated**, this means that only the front passenger front airbag is deactivated. All the other airbags in the vehicle remain activated.

Disconnect the front passenger front airbag

- Switch the ignition off.
- Open the door on the front passenger side.
- Insert the key into the slot of the switch for deactivating the front passenger airbag

»» **Fig. 105.** About 3/4 of the key should enter; this is as far as it will go.

- Turn the key gently to the **OFF** position. If you have difficulty, ensure that you have inserted the key as far as it will go.
- Close the front passenger door.
- Check, with the ignition switched on, that the **OFF** control lamp remains lit where it says **PASSENGER AIR BAG OFF** in the centre of the dash panel »» **Fig. 106.**



Connect the front passenger front airbag

- Switch the ignition off.
- Open the front passenger door.
- Insert the key into the slot of the switch for deactivating the front passenger airbag »» **Fig. 105.** About 3/4 of the key should enter, as far as it will go.
- Turn the key gently to the **ON** position. If you have difficulty, ensure that you have inserted the key as far as it will go.
- Close the front passenger door.
- Check, with the ignition switched on, that the **OFF** control lamp does not remain lit where it says **PASSENGER AIR BAG OFF** in the centre of the dash panel »» **Fig. 106.** The **ON** control lamp lights up for 60 seconds and then goes off.

⚠ WARNING

- The driver of the vehicle is responsible for disabling or switching on the airbag.
- Always switch off the ignition before disabling the front passenger airbag! Failure to do so could result in a fault in the airbag deactivation system.
- Never leave the key in the airbag disabling switch as it could get damaged or enable or disable the airbag during driving.
- If for any reason an airbag is deactivated, reactivate it as soon as possible so that it can fulfil its protective function.



Airbag system control lamps

	It lights up on the combi-instrument
Fault in airbag system and seat belt tensioners.	Have the system checked immediately by a specialised workshop.
OFF 	It lights up on the dash panel
Front passenger front airbag disabled.	Check whether the airbag should remain disabled

ON 	It lights up on the dash panel
Front passenger front airbag enabled.	The control lamp switches off automatically 60 seconds after the ignition is switched on

Several warning and control lamps light up for a few seconds when the ignition is switched on, signalling that the function is being verified. They will switch off after a few seconds.

If the airbag and seat belt tensioner system control lamp  remains on or flashes, it indicates a malfunction in the airbag and seat belt tensioner system **»» ⚠**. Have the system checked immediately by a specialised workshop.

If the front passenger airbag is deactivated, the warning lamp **PASSENGER AIR BAG OFF**  remains lit on the dash panel to remind you that the airbag is deactivated. If, with the front passenger airbag deactivated, this lamp does not remain lit or if it is lit together with the control lamp  on the dash panel, there is a fault in the airbag system **»» ⚠**. If the control lamp is flashing, there is a fault in the disabling of the airbag system **»» ⚠**. Have the system checked immediately by a specialised workshop.

⚠ WARNING

In the event of a fault in the airbag and seat belt tensioner system, the airbags and seat

belts may not trigger correctly, may fail to trigger or may even trigger unexpectedly.

- The vehicle occupants run the risk of sustaining severe or fatal injuries. Have the system checked immediately by a specialised workshop.
- Do not mount a child seat in the front passenger seat or remove the mounted child seat! The front passenger front airbag may deploy during an accident in spite of the fault.

ⓘ CAUTION

Always pay attention to any lit control lamps and to the corresponding descriptions and instructions to avoid damage to the vehicle or harm to the occupants.

Transporting children safely

Child safety

Introduction

For safety reasons, as we have learned from accident statistics, we recommend that children under 12 years of age travel in the rear seats. Depending on their age, height and weight, children travelling in rear seats must use a child seat or a seat belt. For safety reasons, the child seat should be installed in the rear seat, behind the front passenger seat or in the centre back seat.

The physical laws involved and the forces acting in a collision apply also to children **»» page 83**. But unlike adults, children do not have fully developed muscle and bone structures. This means that children are subject to a greater risk of injury.

To reduce the risk of injuries, children must always use special child restraint systems when travelling in the vehicle.

We recommend the use of child safety products from the SEAT Original Accessories Programme, which includes systems for all ages made by "Peke" (not for all countries) (see www.seat.com).

These systems have been especially designed and approved, complying with the ECE-R44. regulation.

SEAT recommends securing the child seats shown on the website as described below:

- Child seats in the opposite direction of travel (group 0+): ISOFIX and support bracket (Peke G0 Plus + ISOFIX Base (RWF)).
- Child seats in the direction of travel (group 1): ISOFIX and Top Tether (Peke G1 ISOFIX DUO Plus).
- Child seats in the direction of travel (group 2): seat belt and ISOFIX (RÖMER KIDFIX XP®).
- Child seats in the direction of travel (group 3): with seat belt (TAKATA MAXI PLUS®).

Follow the manufacturer's instructions and observe any statutory requirements when installing and using child seats. Always read and note **»» page 92**.

We recommend you always carry the manufacturer's Child Seat Instruction Manual together with the on-board documentation.

Important information regarding the front passenger's airbag

Read the additional information carefully **»»  page 24**.

Read and always observe the safety information included in the following chapters:

- Safety distance with respect to the passenger airbag **»» page 86**.
- Objects between the passenger and the passenger side airbag **»»  in Front airbags on page 88**.

The passenger side front airbag, when enabled, is a serious risk for a child that is facing backward since the airbag can strike the seat with such force that it can cause serious or fatal injuries. Children up to 12 years old should always travel on the rear seat.

Therefore we strongly recommend you to transport children on the rear seats. This is the safest location in the vehicle. Alternatively, the front passenger airbag can be disabled with a key-operated switch **»» page 90**. When transporting children, use a child seat suitable for the age and size of each child **»» page 94**.

WARNING

- If a child seat is secured to the front passenger seat, the risk to the child of sustaining critical or fatal injuries in the event of an accident increases.
- An inflating front passenger airbag can strike the rear-facing child seat and project it with great force against the door, the roof or the backrest.

- Never install a child seat facing backwards on the front passenger seat unless the front passenger front airbag has been disabled. Risk of potentially fatal injuries to the child! However, if it is necessary, in exceptional cases, to transport a child in the front passenger seat, the front passenger front airbag must always be disabled » page 90, Activation and deactivation of front passenger airbag*. If the passenger seat has a height adjustment option, move it to the highest, most upright position. If it is a fixed seat, it should be moved to the rearmost position possible.
- For those vehicles that do not include a key lock switch to deactivate the airbag, the vehicle must be taken to a technical service. Do not forget to reconnect the airbag when an adult wants to sit in the front passenger seat.
- All vehicle occupants, especially children, must assume the proper sitting position and be properly belted in while travelling.
- Never hold children or babies on your lap, this can result in potentially fatal injuries to the child!
- Never allow a child to be transported in a vehicle without being properly secured, or to stand up or kneel on a seat while travelling. In an accident, the child could be flung through the vehicle, causing possibly fatal injuries to themselves and to the other vehicle occupants.
- If children assume an improper sitting position when the vehicle is moving, they expose themselves to greater risk of injury in the event of a sudden braking manoeuvre or in an

accident. This is particularly important if the child is travelling on the front passenger seat and the airbag system is triggered in an accident; as this could cause serious injury or even death.

- A suitable child seat can protect your child!
- Never leave a child alone in the child seat or inside the vehicle because depending on the season, very high temperatures may be reached inside a parked vehicle, which could be fatal.
- Children who are less than 1.5 metres tall must not wear a normal seat belt without a child seat, as this could cause injuries to the abdominal and neck areas during a sudden braking manoeuvre or in an accident.
- Do not allow the seat belt to become twisted and the seat belt should be properly in place » page 81.
- Only one child may occupy a child seat » page 93, Child seats.
- When a child seat is mounted in the rear seats, the door child-proof lock should be activated » page 138.

Child seats

Safety instructions

Read the additional information carefully
»  page 23.

WARNING

When travelling, children must be secured in the vehicle with a restraint system suitable for age, weight and size.

- Read and always observe information and warnings concerning the use of child seats » page 92.

WARNING

The retaining rings are designed only for use with "ISOFIX" and Top Tether* system child seats.

- Never secure other child seats that do not have the "ISOFIX" or Top Tether* system, or retaining belts or objects to the fastening rings - this can result in potentially fatal injuries to the child.
- Ensure that the child seat is secured correctly using the "ISOFIX" and Top Tether* securing rings.

WARNING

An undue installation of the safety seat will increase the risk of injury in the event of a crash.

- Never tie the retainer strap to a hook in the luggage compartment.
- Never secure or tie luggage or other items to the lower anchorages (ISOFIX) or the upper ones (Top Tether).

Categorisation of child seats into groups

Use only child seats that are officially approved and suitable for the child.

These seats are subject to the ECE-R 44 or ECE-R 129 standard. ECE-R stands for: Economic Commission for Europe Regulation.

The child seats are grouped into 5 categories:

Group 0: Up to 10 kg (up to around 9 months)

Group 0+: Up to 13 kg (up to around 18 months)

Group 1: from 9 to 18 kg (up to approx. 4 years old)

Group 2: from 15 to 25 kg (up to approx. 7 years old)

Group 3: From 22 to 36 kg (over around 7 years old)

Child seats that have been tested and approved under the ECE-R 44 or ECE-R 129 standard bear the test mark ECE-R 44 or ECE-R 129 on the seat (the letter E in a circle with the test number below it).

Follow the manufacturer's instructions and observe any statutory requirements when installing and using child seats.

We recommend you to always include the manufacturer's Child Seat Instruction Manual together with the on-board documentation.

SEAT recommends you use child seats from the **Original Accessories Catalogue**. These child seats have been designed and tested for use in SEAT vehicles. You can find the right child seat for your model and age group at SEAT dealers.

Child seats by approval category

Child seats may have the approval category of universal, semi-universal, vehicle specific (all according to the ECE-R 44 standard) or i-Size (according to the ECE-R 129 standard).

- **Universal:** Child seats with universal approval can be installed in all vehicles. There is no need to consult any list of models. In the case of universal approval for ISOFIX, the child seat is additionally provided with a Top Tether belt.
- **Semi-universal:** semi-universal approval, in addition to the standard requirements of universal approval, requires safety devices to lock the child seat, which require additional testing. Child seats with semi-universal approval include a list of vehicle models for which they can be installed.
- **Vehicle-specific:** vehicle-specific approval requires a dynamic test of the child seat for each vehicle model separately. Child seats with vehicle-specific approval also include a

list of vehicle models for which they can be installed.

- **i-Size:** Child seats with i-Size approval must meet the requirements prescribed in the ECE-R 129 standard in relation to installation and safety. Child seat manufacturers can tell you which seats have i-Size approval for this vehicle.

Attachment systems

Depending on the country, different attachment systems are used for safely installing child seats.

Attachment systems overview

- **ISOFIX:** ISOFIX is a standardised attachment system allowing quick and safe attachment of child seats in the vehicle. ISOFIX attachment establishes a rigid connection between the child seat and the car body.

The child seat has two rigid attachment clips, called connectors. These connectors are fitted into the ISOFIX attachment rings found between the seat cushion and the backrest of the vehicle's back seat (on the sides). ISOFIX attachment systems are used mainly in Europe »  page 27. If necessary, ISOFIX attachment may have to be supplemented with a Top Tether belt or a support bracket.

- **Automatic three-point seat belt.** Whenever possible, it is preferable to attach the child seats with the ISOFIX system rather than attaching them with an automatic three-point seat belt »  page 25.

Additional attachment:

- **Top Tether:** The Top Tether belt is guided over the back of the rear seat and attached to an anchor point with a hook. Anchor points are located at the back of the rear seat backrest on the boot side »  page 30. The rings for retaining the Top Tether belt are marked with an anchor symbol.

- **Support bracket:** Some child seats rest on the floor of the vehicle with a support bracket. The support bracket prevents the child seat from tipping forward in the event of impact. Child seats fitted with a support bracket should only be used in the passenger seat and side rear seats » . For the assembly of this type of seat you should also consult the list of approved vehicles for this assembly, available in the instructions for child restraint systems.

Recommended systems for attaching child seats

SEAT recommends attaching child seats as follows:

- **Baby carriers or child seats in the opposite direction of travel:** ISOFIX and support bracket or iSize.
- **Child seats in the direction of travel:** ISO-FIX and Top Tether.

WARNING

Incorrect use of the support bracket can cause serious or fatal injury.

- **Make sure the support bracket is correctly and safely installed.**

Event Data Recorder

Description and operation

Your vehicle has an event data recorder (EDR).

The EDR's function is to record data in the event of a mild or serious accident. These data are used to support the analysis of how different vehicle systems behaved.

The EDR records, over a reduced time range (normally 10 seconds or less), dynamic driving data and data from the restraint systems, such as:

- How different vehicle systems worked.
- Whether the driver and the occupants were wearing their seatbelts.
- How hard the acceleration or brake pedal was pressed.
- Vehicle speed.

These data will provide a better understanding of the circumstances of the accident.

Data from the driving assist systems are also recorded. This includes data such as whether the systems were inactive or active and if such action had an impact on the vehicle's dynamic behaviour, changing its path in the aforementioned situations, accelerating or decelerating the vehicle.

Depending on vehicle equipment, this includes data from systems such as:

- Adaptive Cruise Control (ACC)
- Emergency brake assist system (Front Assist).
- Park Pilot system

The EDR data are only recorded in specific accident situations. No data are recorded in normal driving conditions.

No audio or video data inside or around the vehicle are recorded. Under no circumstances are personal data such as name, age, or gender recorded. Nevertheless, third parties (such as criminal proceedings authorities) may relate the contents of the EDR data to other data sources and create a personal reference in the context of an accident investigation.

In order to read the EDR data it is necessary to access (if legally permitted to do so) the vehicle's OBD ("On-Board-Diagnose") interface while the vehicle is switched on.

SEAT will not have access to EDR data unless the owner (or, in "Leasing" cases, the lessee or hirer) gives their consent. There may be exceptions to this, depending on legal or contractual provisions.

Due to legal requirements in safety-related products, SEAT may use the EDR data for field research and in order to improve vehicle sys-

tem quality. Any data used for the purposes of research will be treated anonymously (in other words, no reference will be made to the vehicle, their owner or the lessee/hirer).

Emergencies

Self-help

Emergency equipment

Emergency warning triangle*

The use of reflective warning triangles is obligatory in emergencies in some countries. As are the first aid kit and a set of spare light bulbs.

The warning triangle is under the storage compartment which is located under the luggage compartment floor.

Note

- The warning triangle is not part of the vehicle's standard equipment.
- The warning triangle should meet legal requirements.

First-aid kit and fire extinguisher*

The first-aid kit can go in the storage compartment which is located under the luggage compartment floor.

The fire extinguisher* is attached to the luggage compartment carpet with Velcro.

Note

- The first-aid kit and the fire extinguisher are not part of the vehicle's standard equipment.
- The first aid kit must comply with legal requirements.
- Observe the expiry date of the contents of the first aid kit. After it has expired you should purchase a new one.
- The fire extinguisher must comply with legal requirements.
- Ensure that the fire extinguisher is fully functional. The fire extinguisher should, therefore, be checked regularly. The sticker on the fire extinguisher will inform you of the next date for checking.
- Before acquiring accessories and emergency equipment see the instructions in "Accessories and spares" » page 247.

Vehicle tools

Read the additional information carefully »  page 65

Depending on the equipment, the tools and anti-puncture kit* are stored under the floor panel in the luggage compartment.

The tool kit includes:

- Adapter for anti-theft wheel bolts*
- Towline anchorage

- Box spanner for wheel bolts*
- Jack*
- Wire hook for pulling off the wheel cover* / wheel bolt cap clip.

Some of the items listed are only provided in certain model versions, or are optional extras.

WARNING

- The factory-supplied jack is only designed for changing wheels on this model. On no account attempt to use it for lifting heavier vehicles or other loads. Risk of injury.
- Use the jack only on a firm, level ground.
- Never start the engine when the vehicle is on the jack. Risk of accident.
- If work is to be carried out underneath the vehicle, this must be secured by suitable means. Otherwise, there is a risk of injury.

Note

The jack does not generally require any maintenance. If required, it should be greased using universal type grease.

Tyre repair

TMS (Tyre Mobility System)*

Read the additional information carefully

»  page 64

The Anti-puncture kit* (Tyre Mobility System) will reliably seal punctures caused by the penetration of a foreign body of up to about 4 mm in diameter. **Do not remove foreign objects, e.g. screws or nails, from the tyre.**

After inserting the sealant residue in the tyre, you must again check the tyre pressure about 10 minutes after starting the engine.

You should only use the tyre mobility set if the vehicle is parked in a safe place, you are familiar with the procedure and you have the necessary tyre mobility set! Otherwise, you should seek professional assistance.

Do not use the tyre sealant in the following cases:

- If the wheel rim has been damaged.
- In outside temperatures below -20°C (-4°F).
- In the event of cuts or perforations in the tyre greater than 4 mm.
- If you have been driving with very low pressure or a completely flat tyre.
- If the sealant bottle has passed its use by date.

WARNING

Using the tyre mobility system can be dangerous, especially when filling the tyre at the roadside. Please observe the following rules to minimise the risk of injury:

- Stop the vehicle safely as soon as possible. Park it at a safe distance from surrounding traffic to fill the tyre.
- Ensure the ground on which you park is flat and solid.
- All passengers and particularly children must keep a safe distance from the work area.
- Turn on the hazard warning lights to warn other road users.
- Use the tyre mobility system only if you are familiar with the necessary procedures. Otherwise, you should seek professional assistance.
- The tyre mobility set is intended for temporary emergency use only until you can reach the nearest specialised workshop.
- Replace the repaired tyre with the tyre mobility set as soon as possible.
- The sealant is a health hazard and must be cleaned immediately if it comes into contact with the skin.
- Always keep the tyre mobility set out of the reach of small children.
- Never use a jack, even if it has been approved for your vehicle.
- Always stop the engine, apply the hand-brake lever firmly and engage gear if using a

manual gearbox, in order to reduce the risk of vehicle involuntary movement.

WARNING

A tyre filled with sealant does not have the same performance properties as a conventional tyre.

- Never drive faster than 80 km/h (50 mph).
- Avoid heavy acceleration, hard braking and fast cornering.
- Drive for only 10 minutes at a maximum speed of 80 km/h (50 mph) and then check the tyre.

For the sake of the environment

Dispose of used or expired sealant observing any legal requirements.

Note

- A new bottle of sealant can be purchased at SEAT dealerships.
- Take into account the separate instruction manual of the tyre mobility set* manufacturer.

Contents of the tyre mobility system*

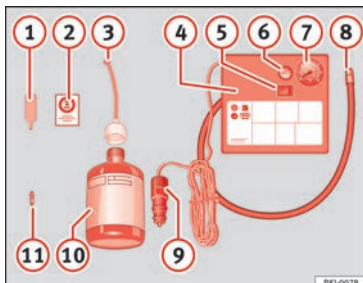

Fig. 107 Standard representation: contents of the anti-puncture kit.

The anti-puncture kit is located underneath the floor covering in the luggage compartment. It includes the following components » Fig. 107:

- ① Valve insert remover
- ② Sticker indicating maximum speed “max. 80 km/h” or “max. 50 mph”
- ③ Filler tube with cap
- ④ Air compressor
- ⑤ ON/OFF switch
- ⑥ Air bleed screw (it can also be integrated in the inflator tube).

- ⑦ Warning provided by tyre pressure monitoring system (it can also be integrated in the inflator tube).
- ⑧ Tube for inflating tyres
- ⑨ 12 volt connector
- ⑩ Bottle of sealant
- ⑪ Spare tyre valve

The **valve insert remover** ① has a gap at the lower end for the valve insert. The valve insert can only be screwed or unscrewed in this way. This also applies to its replacement part ⑪.

⚠ WARNING

When inflating the wheel, the air compressor and the inflator tube may become hot.

- Protect hands and skin from hot parts.
- Do not place the hot flexible inflator tube or hot air compressor on flammable material.
- Allow them to cool before storing the device.
- If it is not possible to inflate the tyre to at least 2.0 bars (29 psi / 200 kPa), the tyre is too badly damaged. The sealant is not in a good condition to seal the tyre. Do not continue driving. Seek specialist assistance.

⚠ CAUTION

Switch off the air compressor after a maximum of 8 operational minutes to avoid over-

heating! Before switching on the air compressor again, let it cool for several minutes.

Check after 10 minutes of driving

Screw in the inflator tube » Fig. 107 ⑧ again and check the pressure on the gauge ⑦.

1.3 bar (19 psi / 130 kPa) and lower:

- **Stop the vehicle!** The tyre cannot be sealed sufficiently with the tyre mobility set.
- You should obtain professional assistance » ⚠.

1.4 bar (20 psi / 140 kPa) and higher:

- Set the tyre pressure to the correct value again.
- Carefully resume your journey, without exceeding 80 km/h (50 mph), until you reach the nearest specialised workshop and replace the tyre.

⚠ WARNING

Driving with an unsealed tyre is dangerous and can cause accidents and serious injury.

- Do not continue driving if the tyre pressure is 1.3 bar (19 psi / 130 kPa) and lower.
- Seek specialist assistance.

Changing the windscreen wiper blades

Changing the windscreen and rear window wiper blades

Read the additional information carefully »  page 73.

Perfect windscreen wiper blade condition is essential for clear vision. Damaged wiper blades should be replaced immediately.

The windscreen wiper blades are supplied as standard with a layer of graphite. This layer is responsible for ensuring that the wipe is silent. If the graphite layer is damaged, the noise of the water as it is wiped across the windscreen will be louder.

Check the condition of the wiper blades regularly. **If the wipers scrape across the glass**, they should be changed if they are damaged, or cleaned if they are dirty » .

If this does not produce the desired results, the setting angle of the windscreen wiper arms might be incorrect. They should be checked by a specialised workshop and corrected if necessary.

WARNING

Do not drive unless you have good visibility through all windows!

- Clean the windscreen wiper blades and all windows regularly.
- The wiper blades should be changed once or twice a year.

CAUTION

- Damaged or dirty windscreen wipers could scratch the glass.
- Never use fuel, nail varnish remover, paint thinner or similar products to clean the windows. This could damage the windscreen wiper blades.
- Never move any windscreen wiper by hand. This could cause damage.
- To prevent damage to the bonnet and the windscreen wiper arms, the latter should only be lifted off the windscreen when in service position.

Note

- The windscreen wiper arms can be moved to the service position only when the bonnet is properly closed.
- You can also use the service position, for example, if you want to fix a cover over the windscreen in the winter to keep it clear of ice.

Towing or tow-starting

General information

Read the additional information carefully »  page 70.

Tow-starting means starting the engine of the vehicle while another pulls it.

Towing means one vehicle pulling another that is not roadworthy.

If the vehicle comes with the Keyless Access system, towing is only allowed with the ignition on!

The vehicle battery drains if the vehicle is towed with the engine switched off and the ignition connected. Depending on the battery charge status, the drop in voltage may be so large, even after just a few minutes, that no electrical device in the vehicle may work e.g. the hazard warning lights. In vehicles with the Keyless Access system, the steering wheel could lock up.

WARNING

If the vehicle has no electrical power, the brake lights, turn signals and all other lights will no longer function. Do not have the vehicle towed away. Failure to follow this instruction could result in an accident.

⚠ WARNING

The risk of accidents is high when tow-starting, for example, the towed vehicle can easily be driven into the towing vehicle.

ⓘ CAUTION

If there is no oil in the gearbox or no lubricant in the automatic transmission the car may only be towed with the driven wheels lifted clear of the road, or transported on a special car transporter or trailer.

ⓘ CAUTION

Do not tow a vehicle for more than 50 m in attempt to start it. There is risk of damage to the catalytic converter.

i Note

- Please observe related legal requirements.
- Switch on the hazard warning lights of both vehicles. However, observe any regulations to the contrary.
- The tow rope must not be twisted. Otherwise the front tow line anchorage could be pulled off the vehicle.

Indications for tow-starting

Vehicle's should not generally be tow-started. The jump start should be used instead
 »  page 71.

For technical reasons, towing the following vehicles is **not** allowed:

- Vehicles with an automatic gearbox.
- If the vehicle battery is discharged, because in vehicles with the Keyless Access locking and ignition system the steering remains locked and the electronic parking brake cannot be deactivated nor can the electronic lock of the steering column be released if they are activated.
- If the battery is flat, it is possible that the engine control units may not operate correctly.

However, if the vehicle must absolutely be tow-started (in the case of manual gearboxes):

- Engage the 2nd or 3rd gear.
- Keep the clutch pressed down.
- Switch on the ignition and the hazard warning lights.
- Once both vehicles are moving, release the clutch.
- Once the engine starts, press the clutch and disengage the gear to avoid colliding with the towing vehicle.

i Note

The vehicle can only be tow-started if the electronic parking brake and, if appropriate, the electronic lock of the steering column are

deactivated. If the vehicle has no power supply or there is an electric system fault, the engine must be tow-started to deactivate the electronic parking brake and the electronic lock of the steering column.

Anchoring the front tow line



Fig. 108 Right side of the front bumper: remove the lid.



Fig. 109 Right side of the front bumper: towline anchorage screwed in.

The front towline anchorage is only mounted if the vehicle has to be towed.

There is a cover with an opening into which the towline anchorage is screwed on the right part of the front bumper.

- Take the towline anchorage from the on-board tool set.
- Remove the front cover by pressing down on its left-hand side » **Fig. 108.**
- Bolt the anchorage to its limit to the *left*, in the direction of the arrow » **Fig. 109.**

After use, unscrew the towline anchorage and fit the cover back on the bumper. Put the towline anchorage back in the vehicle tool kit. The towline anchorage should always be kept in the vehicle.

Rear towline anchorage

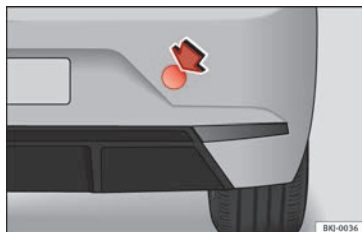

Fig. 110 Right side of the rear bumper: cover-cap.



Fig. 111 Right side of the rear bumper: towline anchorage screwed in.

The rear towline anchorage should only be mounted if you wish to tow another vehicle.

Vehicles with towline anchorage

On the right of the rear bumper there is a cover which covers a threaded hole.

- Take the towline anchorage out of the vehicle tool set » **page 97.**
- To open the cover, press the top right side » **Fig. 110.**
- Screw the towline anchorage into the screw connection as far as it will go » **Fig. 111** and tighten with the wheel brace.

After use, unscrew the towline anchorage and put it back in the vehicle tool kit. Replace the cover on the bumper. The towline anchorage should always be kept in the vehicle.

⚠ WARNING

- If the towline anchorage is not screwed in as far as the stop, there is a risk of the screw connection shearing off during towing (accident risk).
- If your car has a towing bracket, only use special towing ropes. Risk of accident!

⚠ CAUTION

In vehicles fitted with a towing bracket, only use special tow bars to prevent damage to the ball joint. These tow bars have been specially approved for use with towing brackets.

Towing vehicles with a manual gearbox

Towing is relatively straightforward.

Please observe the relevant instructions
» page 100.

The vehicle can be towed using a tow bar or tow rope in the normal way, with all four wheels on the road; it can also be towed with either the front or rear wheels lifted off the road. The maximum towing speed is **50 km/h** (30 mph).

Towing a vehicle equipped with automatic gearbox

Certain restrictions must be observed when towing your vehicle.

Please observe the relevant instructions
» page 100.

The vehicle can be towed with a tow bar or tow rope in the normal way, with all four wheels on the ground. When doing so, please note the following points:

- Make sure the **selector lever is in the N** position.
- The vehicle must not be towed faster than **50 km/h** (30 mph).
- The vehicle must not be towed further than **50 km (30 miles)**. Reason: when the engine is not running, the gearbox oil pump does not work and the gearbox is not adequately lubricated for higher speeds or longer distances.

If the vehicle has to be towed with a **break-down truck**, it must only be suspended at the *front* wheels. Reason: the drive shafts are located on the front wheels. If the car is towed with the rear wheels lifted off the road (i.e. travelling backwards), the drive shafts also turn *backwards*. The planetary gears in the automatic gearbox then turn at such high speeds that the gearbox will be severely damaged in a short time.

i Note

- If it is not possible to tow the vehicle in the normal way, or if it has to be towed further than 50 km (30 miles), it must be transported on a special car transporter or trailer.
- Should the power supply to the selector lever be interrupted in position P, the selector lever will be locked. Before the vehicle can be recovered/manoeuvred you must manually release the selector lever.

Fuses and bulbs

Fuses

Introduction

In general, a fuse can be assigned to various electrical components. Likewise, an electrical component can be protected by several fuses.

Only replace fuses when the cause of the problem has been solved. If a newly inserted fuse blows after a short time, you must have the electrical system checked by a specialised workshop as soon as possible.

WARNING

The high voltages in the electrical system can give serious electrical shocks, causing burns and even death!

- Never touch the electrical wiring of the ignition system.
- Take care not to cause short circuits in the electrical system.

WARNING

Using unsuitable fuses, repairing fuses or bridging a current circuit without fuses can cause a fire and serious injury.

- Never use a fuse with a higher value. Only replace fuses with a fuse of the same amperage (same colour and markings) and size.
- Never repair a fuse.
- Never replace a fuse by a metal strip, staple or similar.

CAUTION

- To prevent damage to the vehicle's electric system, before replacing a fuse always turn off the ignition, the lights and all electrical elements and remove the key from the ignition.
- If you replace a fuse with higher-rating fuse, you could cause damage to another part of the electrical system.
- Protect the fuse boxes when open to prevent the entry of dust or humidity as they can damage the electrical system.
- Always carefully remove the fuse box covers and refit them correctly to avoid problems with your vehicle.

Note

- One component may have more than one fuse.
- Several components may run on a single fuse.
- In the vehicle, there are more fuses than those indicated in this chapter. These should only be changed by a specialised workshop.

- Positions not containing a fuse do not appear in the following tables.
- Some of the equipment listed in the tables below pertain only to certain versions of the model or are optional extras.
- Please note that the above lists, while correct at the time of printing, are subject to change.

Fuses to the left of the instrument panel

Read the additional information carefully
»  page 62

Only replace fuses with a fuse of the same amperage (same colour and markings) and size.

No.	Consumer/Amps	
1	Tow Hook	20
2	Cigarette lighter /Power point	20
3	Sound amplifier	30
5	Panoramic Roof	30
6	Central locking	40
8	Heating fan/Climatronic	30
10	Tow Hook	20
11	GNC solenoid valves	7.5

Fuses and bulbs

No.	Consumer/Amps	
13	Lights switch, steering column LSS and SMLS, diagnostic port, rain/light sensor	7.5
14	steering column LSS: wiper controls	10
15	Instrument panel	7.5
16	Right Lights Power Supply	40
17	Right Door Window Control	30
18	Windscreen wipers	30
19	Radio, Multimedia System	25
20	Heated Rear Window	30
21	SCR Control Unit	30
23	Rear View Camera	7.5
24	Connectivity Box, external audio source wiring (Double USB-Aux IN), telephone amplifier, MIB display	5
25	Steering Column Electronics (MFL)	7.5
26	Gateway	7.5
27	Active Suspension Control Unit	7.5
28	DWA Sensor	7.5
29	DWA Horn	7.5
31	9AA/9AB climate control unit	7.5
	9AK Climatronic control unit	15
32	Steering Column LSS, without Kessy	7.5

No.	Consumer/Amps	
33	Left Door Window Control	30
35	Left Lights Power Supply	40
36	Signal Horn	20
37	Heated seats control unit	30
38	BCM Power C63	30
39	BSD, PDC, MRR	10
40	Lights switch, diagnostic port, headlight range control, steering column LSS: lights, halogen headlights, reverse light switch, electrochromic mirror, RKA without radio	7.5
41	Regulation of unfolded exterior mirrors	7.5
42	Clutch pedal, ignition relays, CNG relay coil, AC sensor pressure	7.5
43	DWP relay coil, rear window wiper motor, heated nozzles	15
44	Airbag	7.5
45	Leimo Plus left headlight	7.5
46	Leimo Plus right headlight	7.5
48	Steering Column Lock, Kessy Control Unit	7.5
49	SCR Relay Coil	7.5
53	Automatic gearbox lever, ZSS	7.5

No.	Consumer/Amps	
58	Double Water Pump	7.5
59	Heated rear view mirrors	10
60	Tow Hook	30
61	Tow Hook	30

Fuse arrangement in engine compartment

Read the additional information carefully
»  page 62

Only replace fuses with a fuse of the same amperage (same colour and markings) and size.

No.	Consumer/Amps	
1	MPI Engine Injection Module	10
	TSI Engine Injection Module	15
	Diesel Engine Injection Module	30
2	Fuel metering valve (TJ4/T6P/TJ7), Low temperature coolant pump (TJ4/T6P/TJ7); Oil Pressure Regulating Valve (TJ1), Coolant Valve AGR (TJ1), High and Low Water Bumps (TJ1), SCR relay coil	7.5
3	Lambda probes	15

»

No.	Consumer/Amps	
4	Petrol engine pump relay (MPI), Gauge control unit (TSI and Diesel)	15
5	Pressure transducer, EPW Solenoid Valve, TOG Sensor, PWM Electric fan, Camshaft Control Valve, Active Carbon Tank Valve and Oil Pressure Regulating Valve (TSI)	10
6	Ignition coils (MPI and TSI)	20
	Glow plug relay, Suction hose resistance (Diesel)	7.5
7	Vacuum pump (TSI)	15
8	Injectors and EKP Relay Coil (MPI and CNG), Fuel metering valve (diesel)	10
9	Servo sensor	7.5
10	Vref Battery: Gateway, BDM and BCM	7.5
14	Engine Injection Module, Main Engine Relay, ESC	7.5
15	Automatic Gearbox DQ200 and AQ160	30
17	50 Diag	7.5
18	Starter Motor	30
20	ESC (Pump)	60
	ABS (Pump)	40
21	ESC/ABS (Valves)	25
24	TH4 Electric fan without A/C for moderate climate countries	30

No.	Consumer/Amps	
25	TH4 fan with A/C or TSI for moderate climate countries	20
	PTC1	40
26	TJ1/TJ4/TJ7/T6P or TH4/TSI Electric fan for warm climate countries	50
27	TH4 fan with A/C or TSI for moderate climate countries	30
	PTC2	40
28	PTC3	40

Changing bulbs

General notes

Read the additional information carefully
 »  page 63

Changing bulbs requires a certain degree of practical skill.

If you choose to change the engine compartment lamps yourself, remember that it is a dangerous area »  in **Safety notes for work in the engine compartment on page 263.**

Always use identical bulbs with the same designation. The name can be found on the base of the bulb holder.

Depending on how equipped the vehicle is, there are different sets of headlights and tail lights:

- Halogen headlights.
- Full-LED main headlights*
- Halogen headlights with LED daytime running lights*
- Rear bulb light
- LED rear light*

Full-LED headlight system*

Full-LED headlights handle all light functions (daylight, side light, turn signal, dipped beam and route light) with light emitting diodes (LEDs) as a light source.

Full-LED headlights are designed to last the lifetime of the car and light bulbs cannot be replaced. In case of headlight failure, go to an authorised workshop to have it replaced.

⚠ WARNING

- **Take particular care when working on components in the engine compartment if the engine is warm, there is a risk of burns.**
- **Bulbs are highly sensitive to pressure. The glass can break when you touch the bulb, causing injury.**
- **When changing bulbs, please take care not to injure yourself on sharp parts in the headlight housing.**

⚠ CAUTION

- Remove the ignition key before working on the electric system. Otherwise, a short circuit could occur.
- Switch off the lights or parking lights before you change a bulb.

♻ For the sake of the environment

Please ask your specialist retailer how to dispose of used bulbs in the proper manner.

📄 Note

- Depending on weather conditions (cold or wet), the front lights, the fog lights, the tail lights and the turn signals may be temporarily misted. This has no influence on the useful life of the lighting system. By switching on the lights, the area through which the beam of light is projected will quickly be demisted. However, the edges may continue to be misted.
- Please check at regular intervals that all lighting (especially the exterior lighting) on your vehicle is functioning properly. This is not only in the interest of your own safety, but also that of all other road users.
- Before changing a bulb, make sure you have the correct new bulb.
- Do not touch the glass part of the bulb with your bare hands, use a cloth or paper towel instead. The residue left by the fingerprints would vaporise as a result of the heat gener-

ated by the bulb, they will be deposited on the reflector and will impair its surface.

- Depending on the level of equipment fitted in the vehicle, LEDs may be used for part or all of the interior and/or exterior lighting. LEDs have an estimated life that exceeds that of the car. If an LED light fails, go to an authorised workshop for its replacement.

Halogen headlights.**Position of the bulbs**

Fig. 112 Halogen headlights.

- A** Turn signal
- B** Main beam headlights
- C** Dipped beam headlights
- D** DRL (daytime running light)/side light

Main beam headlights

Fig. 113 In the engine compartment: main beam headlight bulb.

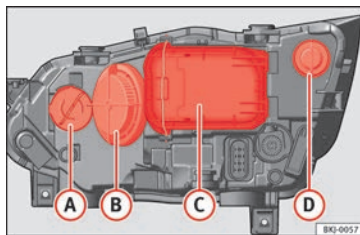
- Raise the bonnet.
- Turn the cover **1** anti-clockwise and take it out **»» Fig. 113.**
- Remove the bulb connector **2** by pulling it outwards.
- Remove the bulb by pulling it out and fit the new one.
- Fit the bulb connector **2**.
- Fit cover **1**, turning it towards the right.
- Check whether the new bulb is working.

Dipped beam headlight

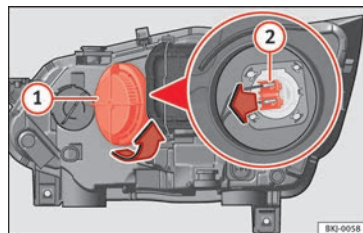
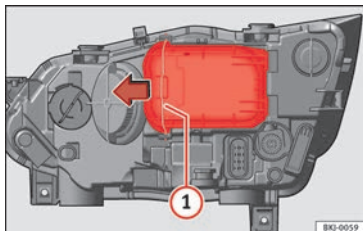

Fig. 114 In the engine compartment: remove the lid.

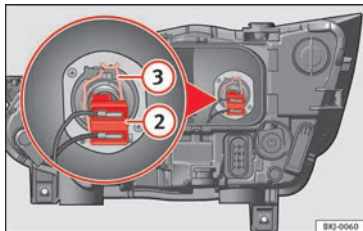

Fig. 115 In the engine compartment: dipped beam headlight.

- Raise the bonnet.

¹⁾ In headlight versions with LED DRL, this light source cannot be replaced. It is designed to last the length of the car's service life. In case of failure, go to an authorised workshop to have it replaced.

- Move the loop » **Fig. 114** ① in the direction of the arrow and remove the cover.
- Remove the bulb connector » **Fig. 115** ②.
- Unclip the retainer spring » **Fig. 115** ③ pressing inwards to the right.
- Extract the bulb and fit the replacement so that the lug on the base fits into the recess on the reflector.
- Fit the connector.
- Fit the cover and close the strap. Make sure that the gasket sits well on the casing cover during the operation.
- Check whether the new bulb is working.

Turn signal light and DRL(daytime running light)¹⁾

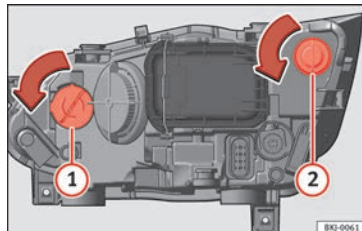

Fig. 116 In the engine compartment: turn signal light bulb ① and DRL (daytime running light) bulb ②.

- Raise the bonnet.
- Turn the bulb holder » **Fig. 116** ① or ② to the left and pull.
- Remove the bulb by pressing on the bulb holder and turning it anticlockwise at the same time.
- Installation involves all of the above steps in reverse sequence.

Changing the fog light bulbs

Front fog light bulb

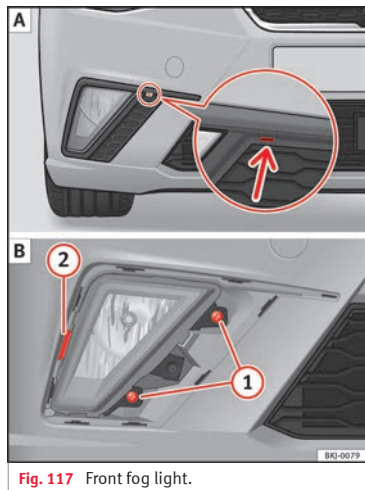

Fig. 117 Front fog light.

Follow the steps indicated:

1. Lever the groove with a screwdriver
 » Fig. 117 A (arrow). Next, remove the clips located on the edge of the grill, levering them gently.

2. Remove the two bolts ① B and lever on the clip ② to remove the fog light.
3. Remove the bulb connector.
4. Turn the bulb holder to the left and pull.
5. Remove the bulb by pressing on it and turning it anticlockwise at the same time.
6. Replace the bulb, making sure that the fixing guides are in the right position and then press it and turn it clockwise.
7. To install the headlight go back through the above steps in reverse.
8. Check that the bulb works properly.

Changing the tail light bulbs

Tail light summary

Bulb light

	Left	Right
Brake lights	2 x P21WLL	2 x P21WLL
Side lights		
Retro fog light	W21W	–
Reverse light	–	W16W
Turn signal	PY 21W NA LL	PY 21W NA LL

Light with LEDs

	Left	Right
Brake lights	LED	LED
Side lights	LED	LED
Retro fog light	LED	–
Reverse light	–	W16W
Turn signal	PY 21W NA LL	PY 21W NA LL

The tables correspond to a right-hand traffic vehicle. The position of lights may vary according to the country.

Changing bulbs

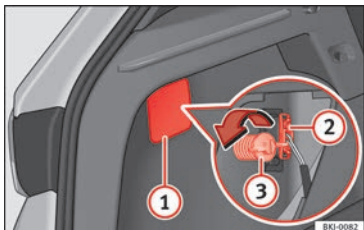

Fig. 118 Luggage compartment: access to the bolt securing the tail light unit.

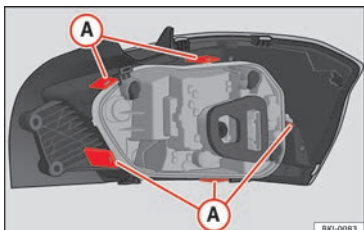

Fig. 119 Retaining tabs on reverse side of tail light.

Follow the steps indicated:

1. Check which of the bulbs is defective.
2. Open the rear lid.

3. Remove the lid, levering the flat side of a screwdriver into the recess
» **Fig. 118 ①**.
4. Remove the bulb connector **②**.
5. Unscrew the bolt securing the light **③** by hand or using a screwdriver.
6. Remove the light from the body, gently pulling it toward you, and place on a clean, smooth surface.
7. Remove the bulb holder unlocking the retaining tabs » **Fig. 119 A**.
8. Change the damaged bulb.
9. To refit follow the steps in reverse order, taking special care when fitting the bulb holder. The securing tabs must click into place.

⚠ CAUTION

Take care when removing the rear light unit to make sure there is no damage to the paintwork or any of its components.

i Note

- Make sure you have a soft cloth ready to place under the glass on the rear light unit, to avoid any scratches.
- For LED lights, you can only change the turn signal and reverse light bulbs.

Number plate light

- Insert the flat part of a screwdriver into the special slot and remove the bulb.
- Remove the bulb holder, by turning it until it is free.
- Change the bulb.
- Replace the bulb holder, by turning it until it fits fully.
- Fit the light into the space and press until you hear a “click”.

Side turn signals

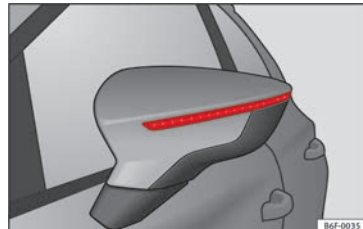

Fig. 120 Turn signal integrated in the rear view mirror

The side turn signals are LEDs and are integrated in the rear view mirrors.

In case of failure, go to an authorised workshop to have it replaced.

Additional brake light

Given the difficulty involved in the replacement of this light it should be done by Technical Services.

Changing the interior bulbs

Interior light and front reading lights

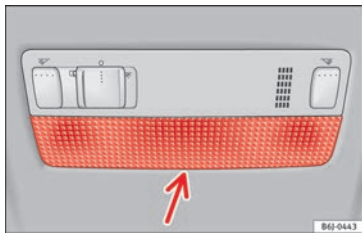

Fig. 121 Front reading light.

To remove the glass

- Insert a fine screwdriver between the casing and the glass »» Fig. 121.
- Carefully remove the glass, levering it to avoid possible damage.

To replace the bulbs

- Pull the bulbs outwards.
- To remove the central bulb, hold and press to one side.

Assembly

- Proceed in the reverse order, pressing gently on the outer edge of the side light.
- First fit the glass with the fastening tabs over the frame of the switch. Next press the front part until the two long tabs click on the support.

Note

In LED courtesy lights it is not possible to replace the light sources. If the light does not work, take the vehicle to an official Service.

Luggage compartment light*

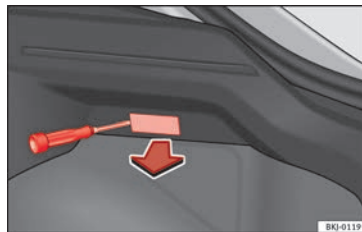

Fig. 122 Boot light.

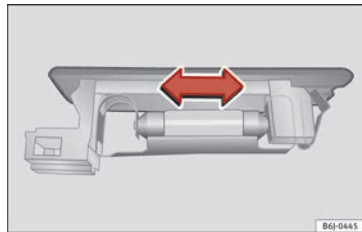

Fig. 123 Boot light.

- Extract the bulb by pressing on its inside edge using the flat side of a screwdriver »» Fig. 122.
- Disconnect the cable.
- Press the bulb sideways and remove it from its housing »» Fig. 123.

- Change the bulb.
- Connect the cable again.
- Refit the bulb and press it in until it engages.

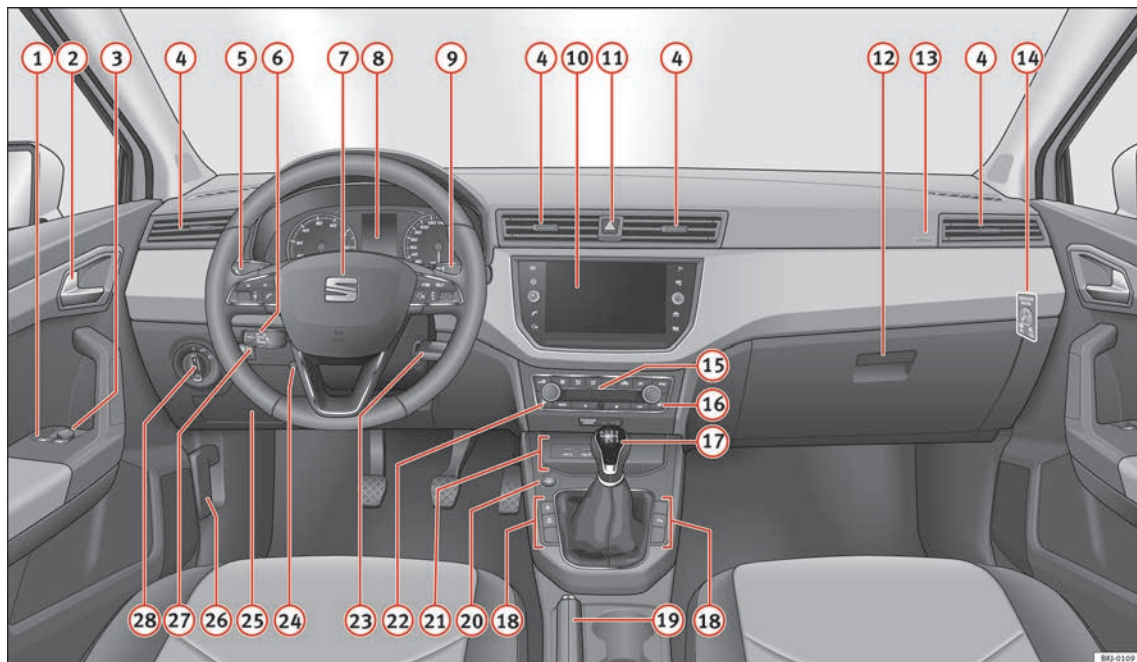

Fig. 124 Dash panel.

BMJ-0109

Operation

Controls and displays

General instrument panel

- | | | | | | |
|--|-----|---|-----|---|-----|
| ① Electric window controls* | 141 | – Warning and indication lamps ... | 47 | – Park assist system | 228 |
| ② Door release lever | | ⑨ Lever for: | | – Tyre pressure monitoring* | 278 |
| ③ Control for adjusting electric exterior mirrors* | 153 | – Windscreen wipers and washer .. | 152 | ⑬ Handbrake lever | 181 |
| ④ Air vents | | – Rear window washer system* ... | 152 | ⑭ Starter button (Keyless Access locking and ignition system) | 178 |
| ⑤ Lever for: | | – Multi-function display control* .. | 37 | ⑮ Depending on the equipment: | |
| – Turn signals/main beam headlights | 147 | ⑩ Infotainment system: | | – USB/AUX-IN input | 129 |
| – Cruise control* | 207 | ⑪ Hazard warning lights | 150 | – Connectivity Box/Wireless Charger* | 129 |
| ⑥ Depending on equipment fitted: | | ⑫ Depending on the equipment, glove compartment with: | 158 | ⑯ Driver seat heating control* | 156 |
| – Lever for cruise control | 207 | – CD player* and/or SD card*
»» Booklet Radio | | ⑰ Ignition lock (vehicles without Keyless Access) | 175 |
| ⑦ Steering wheel with horn and: | | ⑬ Passenger airbag* | 21 | ⑱ Steering column control lever* | 20 |
| – Driver airbag | 86 | ⑭ Front passenger airbag disconnection switch* | 90 | ⑳ Fuse housing | 104 |
| – On-board computer controls | 37 | ⑮ Switches for: | | ㉑ Bonnet release lever | 264 |
| – Controls for radio, telephone, navigation and speech dialogue system »» Booklet Radio | | – Heating and ventilation | 169 | ㉒ Headlight range control* | 150 |
| – Paddle levers for tiptronic gearshift (automatic gearbox) | 192 | – Air conditioning* | 171 | ㉓ Light switch | 146 |
| ⑧ Instrument panel and warning lamps: | | – Climatronic* | 173 | | |
| – Instruments | 117 | ⑯ Front passenger seat heating control* | 156 | | |
| | | ⑰ Gear lever | | | |
| | | – Manual | 189 | | |
| | | – Automatic gearbox | 190 | | |
| | | ⑱ Depending on the equipment, buttons for: | | | |
| | | – Central locking* | 134 | | |
| | | – Start-Stop operation button | 204 | | |
| | | – SEAT Drive Profile | 225 | | |

Note

- Some of the equipment listed in this section is only fitted on certain models or are optional extras.
- A separate Instructions Manual is enclosed if the vehicle is equipped with a factory-fitted radio, CD player, AUX IN connection or navigation system.
- The arrangement of switches and controls on right-hand drive models* may be slightly different from the layout shown in



»» page 115. However, the symbols used to identify the controls are the same.

Instruments and warning/control lamps

Instruments

General instrument panel

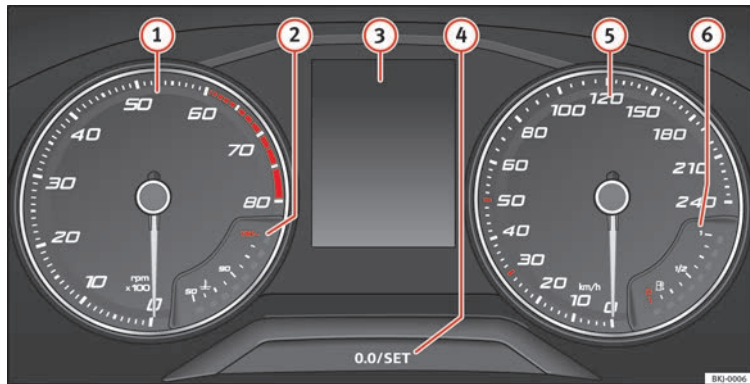

Fig. 125 Instrument panel, on dash panel.

The layout of the instruments depends upon the model and the engine.

- 1 **Rev counter** (with the engine running, in hundreds of revolutions per minute) » page 118.

The beginning of the red zone of the rev counter indicates the maximum speed in any gear after running-in and with the engine hot. However, it is advisable to

change up a gear or move the selector lever to **D** (or lift your foot off the accelerator) before the needle reaches the red zone » 1.

- 2 **Engine coolant temperature display** » page 120; OR:

natural gas gauge in vehicles with natural gas engine (CNG) » page 121.

- 3 **Displays on the screen** »  page 40, » page 118.
- 4 **Adjuster button and display** » page 120.
- 5 **Speedometer.**
- 6 **Fuel gauge** » page 121.

»

⚠ WARNING

Any distraction may lead to an accident, with the risk of injury.

- Do not operate the instrument panel controls when driving.

ⓘ CAUTION

• When the engine is cold, avoid high revs and heavy acceleration and do not make the engine work hard.

Revolution counter

The rev counter indicates the number of engine revolutions per minute » **Fig. 125 ①**.

Together with the gear-change indicator, the rev counter offers you the possibility of using the engine of your vehicle at a suitable speed.

The start of the red zone on the dial indicates the maximum engine speed which may be used briefly when the engine is warm and after it has been run in properly. Before reaching this range, you should change to a higher gear for vehicles with a manual gearbox or for automatic gearboxes put the selector lever in "D" or take your foot off the accelerator pedal.

We recommend that you avoid high revs and that you follow the recommendations on the

gear-change indicator. Consult the additional information in » **Fig. 41**, Gear-change indicator.

ⓘ CAUTION

Never allow the rev counter needle **①** » **Fig. 125** to go into the red zone on the scale for more than a very brief period, otherwise there is a risk of engine damage.

♻ For the sake of the environment

Changing up a gear early will help you to save fuel and minimise emissions and engine noise.

Indications on the display

Read the additional information carefully

» **Fig. 40**

A variety of information can be viewed on the instrument panel display » **Fig. 125 ③** depending on the vehicle equipment:

- Bonnet, rear lid and doors open » **Fig. 40**.
- Information and warning texts.
- Mileage.
- Time.
- Navigation instructions.
- Outside temperature.

- Compass.
- Shift lever position » **page 190**.
- Recommended gear (manual gearbox) » **Fig. 41**.
- Multifunction display (MFD) and menus with different setting options » **Fig. 37**.
- Service interval display » **Fig. 43**.
- Second speed display » **page 119**.
- Speed warning function » **Fig. 42**.
- Start-Stop system status display » **page 204**.
- Active cylinder management display (ACT[®])* » **page 200**
- Low consumption driving status (ECO) » **page 119**
- Engine code (MKB) » **page 119**.



Distance travelled

The *odometer* registers the total distance travelled by the car.

The *odometer (trip)* shows the distance travelled since the last odometer reset. The last digit of the trip recorder indicates distances of 100 metres or one tenths of a mile.

- Briefly press the button » **Fig. 125 ④** to reset the trip recorder to 0.
- Keep the button **④** pressed for about 3 seconds and the previous value will be displayed.

Time

- To set the time, keep the button **» Fig. 125**  pressed for more than 3 seconds to select the hour or minute display.
- To continue setting the time, press button . Hold button down to scroll through the numbers quickly.
- Once you have set the time, the second count will begin from 0 automatically.
- Press the button  again in order to finish setting the time.
- Once you have set the time, the time indicator will disappear and the changes will remain.

The time can also be set on the Easy Connect system using the  button and the function button **SETTINGS > Date and time** **» page 123**.

Compass

With the ignition on and the navigation system on, the cardinal point corresponding to the direction of travel of the vehicle is displayed on the instrument panel.

Selector lever position

The selected gear is displayed on the side of the selector lever and on the instrument panel display. In positions **D** and **S**, and with the Tiptronic, the corresponding gear is also displayed.

Recommended gear (manual gearbox)

The recommended gear in order to save fuel is displayed on the instrument panel while you are driving **»  page 41**.

Second speed display (mph or km/h)

In addition to the speedometer, the speed can also be displayed in a different unit of measurement (in miles or in km per hour).

This option cannot be deactivated in models destined for countries in which the second speed must always be visible.

The second speed display can be adjusted in the Easy Connect system by means of the  button and the function button **SETTINGS > Units** **» page 123**.

Speed warning

When the speed setting is exceeded, this will be indicated on the instrument panel display. This is very useful, for example when using winter tyres that are not designed for driving at the maximum speed of the vehicle **»  page 42**.

The speed warning settings can be adjusted in the Easy Connect system by means of the  button and the function button **SETTINGS > Driver Assistance** **» page 123**.

Start-Stop operating display

Updated information relating to the status is displayed on the instrument panel **» page 204**.

Low consumption driving status (ECO)*

Depending on the equipment, when driving, the “**ECO**” display appears on the instrument panel when the vehicle is in low consumption status due to active cylinder management (ACT®) **» page 200**.

Identifying letters on engine (MKB)

Hold the button **» Fig. 125**  down for more than 15 seconds to display the identifying letters of the vehicle engine (MKB). To do this, the ignition must be switched on and the engine switched off.

WARNING

Observe the safety warnings **»  in Warning symbols on page 122**.

WARNING

Even though outside temperatures are above freezing, some roads and bridges may be icy.

- At outside temperatures above +4°C (+39°F), even when the “ice crystal” symbol is not visible, there may still be patches of ice on the road.
- The outside temperature sensor takes a guideline measurement.

Note

- Different versions of the instrument panel are available and therefore the versions and instructions on the display may vary. In the case of displays without warning or information texts, faults are indicated exclusively by the warning lamps.
- Depending on the equipment, some settings and instructions can also be carried out in the Easy Connect system.
- When several warnings are active at the same time, the symbols are shown successively for a few seconds and will stay on until the fault is rectified.

Odometer



Fig. 126 Instrument panel: odometer and reset button.

The distance covered is displayed in “kilometres” or miles “m”. It is possible to change

the measurement units (kilometres “km”/miles “m”) in the radio/Easy Connect*. Please refer to the Easy Connect* Instructions Manual for more details.

Odometer/trip recorder

The odometer shows the total distance covered by the vehicle.

The trip recorder shows the distance that has been travelled since it was last reset. It is used to measure short trips. The last digit of the trip recorder indicates distances of 100 metres or tenths of a mile.

The trip recorder can be set to zero by pressing **0.0/SET** » **Fig. 126**.

Fault display

If there is a fault in the instrument panel, the letters **DEF** will appear in the trip recorder display. Have the fault repaired immediately, as far as is possible.

Coolant temperature gauge

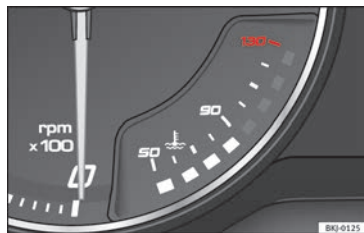



Fig. 127 Instrument panel: coolant temperature gauge

For vehicles with no coolant temperature gauge, a control lamp  appears for high coolant temperatures » **page 269**. Please note » .

The coolant temperature gauge only works when the ignition is switched on » **Fig. 127**. In order to avoid engine damage, please read the following notes for the different temperature ranges.



Engine cold

If only the diodes in the lower part of the scale light up, this indicates that the engine has not yet reached operating temperature. Avoid high revs and heavy acceleration and do not make the engine work hard.

Normal temperature

If in normal operations, the diodes light up until the central zone, it means that the engine has reached operating temperature. At high outside temperatures and when making the engine work hard, the diodes may continue lighting up and reach the upper zone. This is no cause for concern, provided the control lamp  does not light up on the instrument panel digital display.

Heat range

When the diodes light up in the upper area of the display and the control lamp appears  on the instrument panel display, the coolant temperature is excessive  page 269.

ⓘ CAUTION

• To ensure a long useful life for the engine, avoid high revs, driving at high speed and making the engine work hard for approximately the first 15 minutes when the engine is cold. The phase until the engine is warm also depends on the outside temperature. If necessary, use the engine oil temperature*  page 42 as a guide.

• Additional lights and other accessories in front of the air inlet reduce the cooling effect of the coolant. At high outside temperatures and high engine loads, there is a risk of the engine overheating.



• The front spoiler also ensures proper distribution of the cooling air when the vehicle is



moving. If the spoiler is damaged this can reduce the cooling effect, which could cause the engine to overheat. Seek specialist assistance.



Fuel level



Fig. 128 Fuel gauge.

The display  Fig. 128 only works when the ignition is switched on. When the display reaches the reserve mark, the lower diode lights up in red and the control lamp  appears  page 117. When the fuel level is very low, the lower diode flashes in red.

The fuel range is displayed on the instrument panel  Fig. 125 .

You can consult the tank capacity of your vehicle in the   page 57 section.

ⓘ CAUTION



Never run the fuel tank completely dry. An irregular fuel supply could cause misfiring. In this way the unburned fuel can reach the exhaust system, which could cause the catalytic converter to overheat resulting in damage.





Fuel level - Natural Gas (GNC)



✓ Valid in vehicles equipped with natural gas engine (GNC)



Fig. 129 Instrument panel: Natural gas gauge

The gauges  Fig. 129 and  Fig. 128 only work when the ignition is on. When the display reaches the reserve mark, the lower LED lights up in red and the control lamp  appears. When the fuel level is very low, the lower diode flashes in red.

• The green warning lamp   Fig. 129  lights up when the vehicle is running in natural gas operating mode. 

- The green warning lamp  ① turns off when the natural gas is exhausted. The engine changes to operate with petrol.
- The yellow control lamp  lights up when the reserve level has been reached.

Things to note

If the vehicle is left parked for a long time immediately after refuelling, the natural gas level indicator may not accurately indicate the same level shown after refuelling when the vehicle is started up again. This is not due to a leak in the system, but to a drop in pressure in the gas tank for technical reasons after a cooling phase just after refuelling.

Warning and control lamps

Warning symbols

Read the additional information carefully
 »  page 47

There are red warning symbols (priority 1) and yellow warning symbols (priority 2).

Warning messages, Priority 1 (red)



If one of these faults occurs, the warning lamp will light up or flash and will be accompanied by **three audible warnings**. This is a **danger** warning. Stop the vehicle and switch

off the engine. Check the fault and correct it. Obtain professional assistance if necessary.

If several priority 1 faults are detected at the same time, the symbols will be displayed one after the other for about 2 seconds at a time and will continue until the fault is corrected.

No menus will be shown in the display for the duration of a priority 1 warning message.

Examples of priority 1 warning messages (red)

- Brake system symbol  with the warning message **STOP BRAKE FLUID INSTRUCTION MANUAL** or **STOP BRAKE FAULT INSTRUCTION MANUAL**.
- Coolant symbol  with the warning message **STOP SEE COOLANT INSTRUCTION MANUAL**.
- Engine oil pressure symbol  with the warning message **STOP ENGINE OIL PRESSURE LOW! INSTRUCTION MANUAL**.

Warning messages, Priority 2 (yellow)

If one of these faults occurs, the corresponding warning lamp lights up and is accompanied by **an audible warning**. Check the corresponding function as soon as possible although the vehicle may be used without risk.

If several priority 2 warning messages are detected at the same time, the symbols are displayed one after the other for about 2 sec-

onds at a time. After a set time, the information text will disappear and the symbol will be shown as a reminder at the side of the display.

Priority 2 warning messages will not be shown until all **Priority 1** warning messages have been dealt with!

Examples of priority 2 warning reports (yellow):*

- Fuel warning light with the information text **PLEASE REFUEL**.

WARNING

If the warning lamps and messages are ignored, the vehicle may stall in traffic, or may cause accidents and severe injuries.

- Never ignore the warning lamps or text messages.
- Stop the vehicle safely as soon as possible.
- Park the vehicle away from traffic and ensure that there are no highly flammable materials under the vehicle that could come into contact with the exhaust system (e.g. dry grass, fuel).
- A faulty vehicle represents a risk of accident for the driver and for other road users. If necessary, switch on the hazard warning lamps and put out the warning triangle to advise other drivers.
- Before opening the bonnet, switch off the engine and allow it to cool.

- In any vehicle, the engine compartment is a hazardous area and could cause severe injuries »» page 263.

ⓘ CAUTION

Failure to heed the control lamps and text messages when they appear may result in faults in the vehicle.

Introduction to the Easy Connect system*

System settings (CAR)*

Car menu

Read the additional information carefully »»  page 34

To select the settings menus, depending on the version, press the Easy Connect button **(CAR)** and the **(SETTINGS)** function button. **OR** press the button and then **(SETTINGS)** .

The actual number of menus available and the name of the various options in these menus will depend on the vehicle's electronics and equipment.

When the function button check box is activated , the function is active.

Pressing the menu button  will always take you to the last menu used.

Any changes made using the settings menus are automatically saved on closing those menus.

Menu Vehicle settings	Page
ESC system	»» page 183
Tyres	»» page 278

Menu Vehicle settings	Page
Lights	»» page 146
Driver assistance	»» page 216 »» page 212 »» page 227
Parking and manoeuvring	»» page 232
Ambient lighting	»» page 151
Mirrors and windscreen wipers	»» page 153 »» page 33
Opening and closing	»» page 143 »» page 132
Instrument panel	»» page 38
Date and time	–
Units	–
Service	»» page 43
Factory settings	–

WARNING

Any distraction may lead to an accident, with the risk of injury. Operating the Easy Connect system while driving could distract you from traffic.

Communications and multi-media

Steering wheel controls*

General information

The steering wheel includes a multifunction module from where it is possible to control the audio, telephone and radio/navigation functions without needing to distract the driver.

There are two versions of the multifunction module:

- **Audio, telephone and navigation with voice control version:** for controlling the audio functions available (radio, audio CD, MP3, iPod^{®1)}, USB¹⁾, SD¹⁾) and Bluetooth system from the steering wheel.
- **Audio, telephone and navigation without voice control version:** for controlling the audio functions available (radio, audio CD, MP3, iPod^{®1)}, USB¹⁾, SD¹⁾) and Bluetooth system from the steering wheel.

¹⁾ Depending on the vehicle equipment.

Operating the audio, telephone and navigation system with voice control

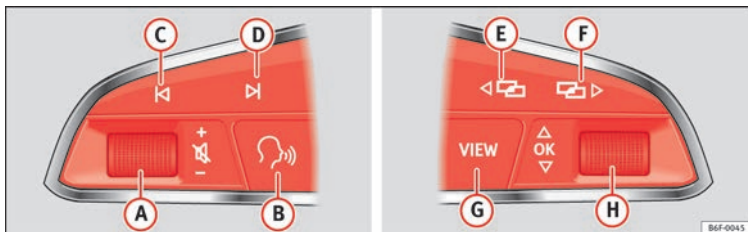





Fig. 130 Controls on the steering wheel.

Button	Radio	Media (except AUX)	AUX	Telephone ^{a)}	Navigation ^{a)}
A Turn	Turn volume up/down. You do not need to be in audio mode (radio).	Turn volume up/down. You do not need to be in audio mode (media).	Turn volume up/down. You do not need to be in audio mode (media).	Turn volume up/down. You do not need to be in telephone mode.	Turn announcement volume up/down. You do not need to be in navigation mode but there has to be an announcement active when you adjust the volume.
A Press	Mute volume.	Mute volume.	Mute volume.	Mute incoming call.	Mute the current navigation announcement.
B ^{a)}	Activate/deactivate voice control. This function can be used from any mode (audio, media, navigation, assistants, vehicle status, travel data). When the system is in telephone mode this button's function is deactivated during the ongoing call, and without Radio/Media functionality (except AUX).				
C / D	Search for the previous/next station ^{b)} .	Short press: Switch to the previous/next song. Hold down: Fast rewind/forward ^{c)} .	No function	– There is no active call: Radio/Media functionality (except AUX) – Active call: no function	No function for the other modes (navigation, assistants, vehicle status, travel data).
E / F ^{a)}	Change instrument panel menu. This function can be used from any mode (audio, media, navigation, assistants, vehicle status, travel data).				

»

Operation

Button	Radio	Media (except AUX)	AUX	Telephone ^{a)}	Navigation ^{a)}
	<i>Coloured instrument panel:</i> switch to the previous menu. <i>Monochrome instrument panel:</i> switch to the previous function.				
 Turn	<i>Coloured instrument panel:</i> List of stations available (only if the instrument panel is in audio menu).	<i>Coloured instrument panel:</i> next track (only if the instrument panel is in audio menu).	No function	– <i>There is no active call:</i> List of latest calls. – <i>Active call:</i> access the call options list (call on hold, hang up, mute microphone, private number, etc.).	– <i>Active route:</i> access the view to halt guidance to destination. – <i>No active route:</i> list of recent destinations.
 Press	Acts on the instrument panel or confirms the instrument panel menu option depending on the menu option.				

- a) According to the vehicle's equipment package.
- b) This action can be performed when you are listening to the radio; there is no need to be in audio-radio mode.
- c) These actions can be performed when you are listening to media; there is no need to be in audio-radio mode.

Operating the audio, telephone and navigation system with voice control

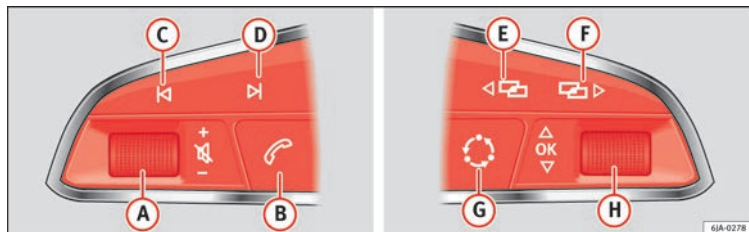





Fig. 131 Controls on the steering wheel.

Button	Radio	Media (except AUX)	AUX	Telephone ^{a)}	Navigation ^{a)}
A Turn	Turn volume up/down. You do not need to be in audio mode (radio).	Turn volume up/down. You do not need to be in audio mode (media).	Turn volume up/down. You do not need to be in audio mode (media).	Turn volume up/down. You do not need to be in telephone mode.	Turn announcement volume up/down. You do not need to be in navigation mode but there has to be an announcement active when you adjust the volume.
A Press	Mute volume.	Mute volume.	Mute volume.	Mute incoming call.	Mute the current navigation announcement.
B ^{a)}	– <i>Incoming call</i> : pick up (short press), reject (hold down). – <i>Active call</i> : hang up active call (short press). – <i>No active/incoming call</i> : open telephone menu (short press), redial the last active call (hold down). These functions can be used from any mode (audio, media, navigation, assistants, vehicle status, travel data).				
C / D	Search for the previous/next station ^{b)} .	<i>Short press</i> : Switch to the previous/next song. <i>Hold down</i> : Fast rewind/forward ^{c)} .	No function	– <i>There is no active call</i> : Radio/Media functionality (except AUX) – <i>Active call</i> : no function	No function for the other modes (navigation, assistants, vehicle status, travel data).
E / F ^{a)}	Change instrument panel menu. This function can be used from any mode (audio, media, navigation, assistants, vehicle status, travel data).				

Operation

Button	Radio	Media (except AUX)	AUX	Telephone ^{a)}	Navigation ^{a)}
	Cycles through the audio source: FM/AM – CD – SD - USB - AUX - BT Audio (only those that are available). This function can be used from any mode (audio, media, navigation, assistants, vehicle status, travel data).				
 Turn	<i>Coloured instrument panel:</i> List of stations available (only if the instrument panel is in audio menu).	<i>Coloured instrument panel:</i> next track (only if the instrument panel is in audio menu).	No function	– <i>There is no active call:</i> List of latest calls. – <i>Active call:</i> access the call options list (call on hold, hang up, mute microphone, private number, etc.).	– <i>Active route:</i> access the view to halt guidance to destination. – <i>No active route:</i> list of recent destinations.
 Press	Acts on the instrument panel or confirms the instrument panel menu option depending on the menu option.				

^{a)} According to the vehicle's equipment package.

^{b)} This action can be performed when you are listening to the radio; there is no need to be in audio-radio mode.

^{c)} These actions can be performed when you are listening to media; there is no need to be in audio-radio mode.

Multimedia

USB/AUX-INPort



Fig. 132 Centre console: USB/AUX-IN input.

Depending on the special characteristics and the country, the vehicle may have a USB/AUX-IN port.

The USB/AUX-IN port can be found in the storage compartment area of the centre console » Fig. 132.

The operating description is located in the respective Instruction Manuals of the audio system or the navigation system.

Connectivity Box* / Wireless Charger*



Fig. 133 Related video



Fig. 134 Centre console: Connectivity Box.

Depending on the features and the country, the vehicle may have one of these two options: *Connectivity Box* or *Wireless Charger*.

With the Connectivity Box you can charge your mobile device wirelessly with Qi¹⁾ technology as well as reduce the radiation in the vehicle and have better reception.

With the Wireless Charger you only have the wireless charging function if your mobile device has Qi technology.

The Connectivity Box/Wireless Charger is in the storage compartment area of the centre console » Fig. 134.

The operating description is located in the respective Instruction Manuals of the audio system or the navigation system.

Note

Your mobile device must support the Qi wireless inductive charging interface standard for proper operation.

¹⁾ Qi technology allows you to charge your mobile phone wirelessly.

Opening and closing

Keys

Set of keys



Fig. 135 Set of keys.

The set of keys may consist of the following, depending on the version of your vehicle:

- a remote control key » Fig. 135 A
- a key without remote control B,
- a plastic key tab* C.

or

- two keys with remote control B
- a plastic key tab* C.

Duplicate keys

If you need a replacement key, go to a Technical Service with your vehicle identification number.

⚠ WARNING

- An incorrect use of the keys can cause serious injuries.
- Never leave children or disabled persons in the vehicle. In case of emergency, they may not be able to leave the vehicle or manage on their own.

• An uncontrolled use of the key could start the engine or activate any electric equipment (e.g. electric windows), causing risk of accident. The doors can be locked using the remote control key. This could become an obstacle for assistance in an emergency situation.

• Never forget the keys inside the vehicle. An unauthorised use of your vehicle could result in injury, damage or theft. Therefore always take the key with you when you leave the vehicle.

• Never remove the key from the ignition if the vehicle is in motion. Otherwise, the steering could suddenly block and it would be impossible to steer the vehicle.

⚠ CAUTION

There are electronic components in the remote control key. Avoid wetting and hitting the keys.

Remote control*

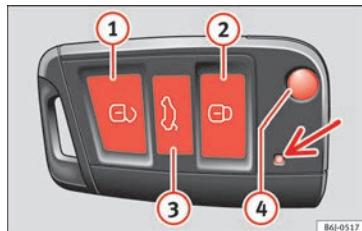

Fig. 136 Assignment of buttons on the remote control key.





Fig. 137 Vehicle key with alarm button.

The radio frequency remote control key is used to lock and unlock the vehicle from a distance.

By using button 4 » Fig. 136 on the control, the key shaft is released.

Unlocking the vehicle » Fig. 136 1.

Locking the vehicle  **» Fig. 136 ②.**

Unlocking the rear lid. Press button  **» Fig. 136 ③** until all the turn signals on the vehicle flash briefly. When the unlocking button  ③ is pressed, you have 2 minutes to open the door. Once this time has passed, it will lock again.

Moreover, the battery indicator on the key **» Fig. 136** (arrow), will flash.

The remote control transmitter and the batteries are integrated in the key. The receiver is inside the vehicle. The maximum range depends on different factors. The range is reduced as the batteries start to lose power.

Alarm button*

Only press alarm button in the event of an emergency **» Fig. 137 ⑤!** When the alarm button is pressed, the vehicle horn is heard and the turn signals are switched on for a short time. When the alarm button is pressed again, the alarm is switched off.

WARNING

Read and observe the relevant warnings **»**  in Set of keys on page 130.

Note

• The remote control key works only when you are in its scope.

• If the vehicle cannot be unlocked or locked by using the radio frequency remote control, the remote control key will have to be re-synchronised. For this, go to your technical services.

Replacing the battery

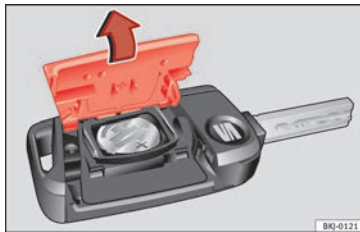

Fig. 138 Vehicle key: opening the battery compartment.

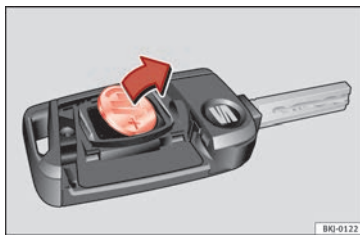

Fig. 139 Vehicle key: removing the battery.

SEAT recommends you ask a specialised workshop to replace the battery.

The battery is located to the rear of the vehicle key, under a cover.

Changing the battery

- Unfold the vehicle key blade **» page 130.**
- Remove the cover from the back of the vehicle key **» Fig. 138** in the direction of the arrow **» ①.**
- Extract the battery from the compartment using a suitable thin object **» Fig. 139.**
- Place the new battery in the compartment as shown **» Fig. 139**, pressing in the opposite direction to that shown by the arrow **» ①.**
- Fit the cover as shown **» Fig. 138**, pressing it onto the vehicle key casing in the opposite direction to that shown by the arrow until it clicks into place.

CAUTION

- If the battery is not changed correctly, the vehicle key may be damaged.
- Use of unsuitable batteries may damage the vehicle key. For this reason, always replace the dead battery with another of the same voltage, size and specifications.
- When fitting the battery, check that the polarity is correct.



 For the sake of the environment

Please dispose of your used batteries correctly and with respect for the environment.



Synchronising the remote control key

If it is not possible to unlock or lock the door with the remote control, it should be re-synchronised.

While the vehicle is open:

- Press the  button  » **Fig. 136** on the remote control.
- Then close the vehicle using the key shaft **within one minute**.

While the vehicle is closed:

- Press the  button  » **Fig. 136** on the remote control.
- Then close the vehicle using the key shaft **within one minute**.

It is possible that the vehicle could no longer be opened and closed with the remote control if the button  is repeatedly pressed outside of the effective range of the radio frequency remote control. The remote control key will have to be resynchronised.

Spare remote control keys are available at your Technical Service, where they must be matched to the locking system.

Up to five remote control keys can be used.

Central locking system

Description

Read the additional information carefully »  page 15.

The central locking system enables you to lock and unlock all doors and the rear lid by just pushing the button.

Central locking can be activated by using any of the following options:

- **the key**, by inserting it into the driver door cylinder and rotating it in the opening direction. Depending on the vehicle version, either all doors will be unlocked or only the driver door will be unlocked. All doors will be locked on locking the vehicle using the key.
- **the interior central lock button** » page 134.
- **the radio frequency remote control**, using the buttons on the key » page 130.

Various functions are available to improve the vehicle safety:

- Locking system “Safe*”
- Selective* unlocking system
- Self-locking system to prevent involuntary unlocking
- Automatic speed dependent locking and unlocking system*
- Emergency unlocking system

Unlocking the vehicle*

- Press the  button » **Fig. 136** on the remote control to unlock all the doors and the rear lid.

Locking the vehicle*

- Press the  button » **Fig. 136** on the remote control to lock all doors and the rear lid or turn the key in the door to lock all doors and the rear lid.

WARNING

- **Locking from the outside carelessly or without good visibility may lead to bruising, particularly in the case of children.**
- **When locking a vehicle, never leave children unaccompanied inside, as from the outside it will be difficult to provide assistance if required.**
- **Having the doors locked prevents intruders from getting in, for example when stopped at a traffic light.**

Note

For anti-theft security, only the driver door is fitted with a lock cylinder.

Safe security system*¹⁾

This is an anti-theft device which consists of a double lock for the door locks and a deactivation function for the boot in order to prevent forced entry.

Activation

The “safe” system is activated when the vehicle is locked using the key or the remote control.

To activate it with the key, rotate once it is inserted in the door lock cylinder in the locking direction.

To activate the system using the remote control, press the lock button once  on the remote.

Once this system is activated, opening doors from the outside and the inside is not possible. The rear lid can not be opened. The central lock button does not work.

When the ignition is switched off, the instrument panel display indicates that the “Safe” system is on.

Deactivation

Rotate the key inserted in the lock cylinder twice towards the locking direction.

To activate the system using the remote control, press the lock button on the remote twice  in less than five seconds.

On deactivating the “Safe” system, the alarm volumetric sensor is also deactivated.

With the “Safe” switched off, doors can be opened from the interior but not from the exterior.

See “Selective unlocking system**”

“Safe” status

On the driver door, there is warning lamp visible from outside the vehicle through the window which shows the “Safe” system status.

We will know that “Safe” system is activated by the flashing warning lamp. The indicator will flash on all vehicles, fitted and not fitted with an alarm, until they unlock.

Remember:

Safe activated with or without an alarm: warning lamp flashes continuously.

Safe deactivated without an alarm: the warning lamp stays off.

Safe deactivated with an alarm: the warning lamp stays off.

WARNING

No one should remain inside the vehicle if the “Safe” system is activated because opening the doors will not be possible in the event of an emergency neither from the inside nor the outside and help from the outside is made difficult. Danger of death. Passengers could become trapped inside in case of emergency.

Selective unlocking system*

This system allows to unlock either just the driver door or all the vehicle.

Driver door unlock button

Unlock once. Use either the key or the remote control.

Once the key is inserted in the lock cylinder, rotate once in the unlock direction. The driver door will remain without “Safe” and unlocked. In vehicles fitted with an alarm, see the Anti-theft Alarm section **»» page 138**.

Using the remote control, press the unlock button on the remote  once. The “Safe” system for all the vehicle is deactivated, only the **»**

¹⁾ Available depending on market and version.

driver door is unlocked and both the alarm and the warning lamp are also turned off.

Unlocking all doors and the luggage compartment

The unlock button on the remote control must be pressed twice  so that all doors and the luggage compartment can be opened.

Press twice within 5 seconds to deactivate the “Safe” system for all vehicle, to unlock all doors and to use the luggage compartment. The warning lamp and the alarm (only vehicles fitted with one) are turned off.

Unlocking the luggage compartment

See  page 16.

Self-locking system to prevent involuntary unlocking

It is an anti-theft system and prevents the unintentional unlocking of the vehicle.

If the vehicle is unlocked and none of the doors (including the boot) are opened within 30 seconds, it re-locks automatically.

Automatic speed-dependent locking and unlocking system*

This is a safety system which prevents access to the vehicle from the outside when it is running (e.g. when stopped at a traffic light).

Locking

The doors will lock automatically if the speed of 15 km/h (9 mph) is exceeded. The rear lid will lock automatically if the speed of 6 km/h (4 mph) is exceeded.

If the vehicle is stopped and any of its doors open, when starting again and exceeding the mentioned speed, all doors will lock again.

Unlocking

On withdrawing the ignition key, the vehicle will return to its status prior to self-locking.

Each door can be unlocked and opened independently from the inside (for example, when a passenger gets out). To do it, simply operate the lever inside the door.

WARNING

The door handles must not be operated when the vehicle is running: the door would open.

Note

If the airbags are triggered during an accident, the vehicle is unlocked, except for the

luggage compartment. It is possible to lock the vehicle from inside with the central locking, after turning the ignition off and back on again.

Central lock button*



Fig. 140 Central lock button.

Read the additional information carefully page 15

The central lock button allows you to lock and unlock the vehicle from the inside.

The central lock button also works with the ignition switched off, except when the “safe” system is activated.

Please note the following if you lock your vehicle with the central lock button:

- Locking the doors and rear lid prevents access from the *outside* (for safety reasons, e.g. when stopped at a traffic light).
- The driver door cannot be locked while it is open. This avoids the user from forgetting his key inside the vehicle.
- All doors can be unlocked separately from inside the vehicle. To do so, pull the door release lever *once*.



Fig. 142 Technology

Unlocking and locking the vehicle with Keyless Access*

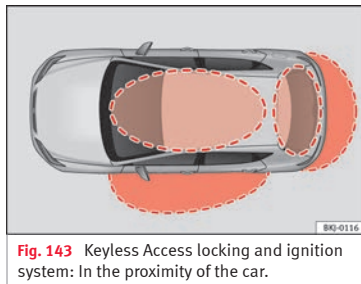

Fig. 143 Keyless Access locking and ignition system: In the proximity of the car.

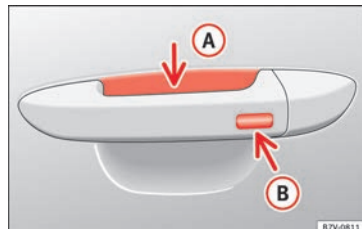

Fig. 144 Keyless Access locking and ignition system: sensor surface A for unlocking inside the door handle and sensor surface B for locking on the exterior of the handle.

⚠ WARNING

- If the vehicle is locked, children and disabled people may be trapped inside it.
- Repeated operation of central locking will prevent the central lock button from working for a few seconds. Then, it can only be unlocked in case it has been previously locked. After few seconds, the central locking becomes operative again.
- The central lock button is not operative when the vehicle is locked from the outside (with the remote control or the key).

Related videos Keyless Access



Fig. 141 Convenience

Depending on the equipment, the vehicle may have the Keyless Access system.

Keyless Access is a key-free locking and ignition system to unlock and lock the vehicle without actively using its key. To do this, all that is required is to have a valid vehicle key in the detection area where you are attempting to access the vehicle » Fig. 143 and to touch one of the sensor surfaces on the door handles » Fig. 144 » ❶.

The vehicle can be unlocked and locked via the driver door only. When doing so, the remote control key must be no further than approx. 1.5 m from the door handle.

It does not matter where you carry the key, for instance whether it is in your jacket pocket or in a briefcase.

Once the doors have been locked, they cannot be opened again immediately. This will enable you to check that the doors are properly closed.

If you wish, when unlocking, you can unlock *only* the driver's door, the side being unlocked, or the entire vehicle. The necessary adjustments can be performed in vehicles with a driver information system

»  page 34.

General information

If a valid key is located in the proximity of the car » **Fig. 143**, the Keyless Access locking and starting system gives the key entry as soon as one of the sensor surfaces on the driver door handle is touched. The following features are then available without having to use the vehicle key actively:

- **Keyless-Entry:** unlocking the vehicle using the handle of the front driver's door or the *softtouch*/handle on the rear lid.
- **Keyless-Exit:** locking the vehicle using the sensor on the driver door handle.
- **Press & Drive:** keyless starting of the engine with the starter button » **page 178**.

The central locking and locking systems operate in the same way as a *normal* locking and unlocking system. Only the controls change.

Unlocking the vehicle is confirmed with a *double* flash of the indicator lights; locking by a *single* flash.

If the vehicle is locked and then all doors and the rear lid are closed leaving the last key used inside the vehicle and none outside, the vehicle will **not** lock **immediately**. All the vehicle's indicator lights will flash *four times*. The vehicle will lock after a few seconds if you do not open any door or the rear lid.

The vehicle will lock again after a few seconds if you unlock the vehicle but fail to open any door or boot hatch.

Unlocking and opening the doors (Keyless-Entry)

- Grip the driver door lever. In doing this, the sensor surface » **Fig. 144**  (arrow) on the handle is touched and the vehicle unlocks.
- Open the door.



On vehicles with selective opening or infotainment system configuration, pulling the door handle twice will unlock all doors.

On vehicles without a "Safe" security system: shutting and locking doors (Keyless-Exit)

- Switch the ignition off.
- Close the driver's door.

- Touch (*once*) the locking sensor surface  (arrow) on the driver door handle. The door that is used must be closed.

On vehicles with a "Safe" security system: shutting and locking doors (Keyless-Exit)

- Switch the ignition off.
- Close the driver's door.
- Touch (*once*) the locking sensor surface  (arrow) on the driver door handle. The vehicle locks with the "Safe" » **page 133** system. The door that is used must be closed.
- Touch (*twice*) the sensor surface  (arrow) of the driver door handle to lock the vehicle without activating the "Safe" security system » **page 133**.

Unlocking and locking the boot hatch

When the vehicle is locked, the rear lid automatically unlocks on opening if there is a valid vehicle key in the proximity » **Fig. 143**.

Open or close the rear lid *normally*.

After closing, the hatch locks automatically. If the complete vehicle is unlocked, the rear lid will **not** lock automatically after closing it.

What happens when locking the vehicle with a second key

If there is a vehicle key inside the vehicle and it is locked from the outside with a second vehicle key, the key inside the vehicle is

blocked for engine ignition » page 175. In order to enable engine ignition, the button on the key  inside the vehicle needs to be pressed.

Automatically disabling sensors

If the vehicle is not locked or unlocked for a long period of time, the proximity sensors on the passenger doors are automatically disabled.



If one of the sensor surfaces on the door handles is often activated in an unusual manner with the vehicle locked (e.g. by the branches of a bush rubbing against it), all proximity sensors are disabled for a certain period of time.

Sensors will again be enabled:

- After a time.
- **OR:** If the vehicle is unlocked with the  button on the key.
- **OR:** if the boot is opened.
- **OR:** if the vehicle is unlocked manually with the key.

Keyless Access temporary disconnection function*

You can deactivate the vehicle's Keyless Access unlocking for a locking and unlocking cycle.



- Move the gear lever to position **P** (if the vehicle has automatic gearbox), since otherwise the vehicle cannot be locked.
- Close the door.
- Push the central locking button  on the remote control and touch the locking sensor surface » Fig. 144  on the driver door handle once within the following 5 seconds. Do not grip the door handle, otherwise the vehicle will not lock. Deactivation is also possible if the vehicle is locked through the driver's door lock.
- To check that the function has been deactivated, wait at least 10 seconds, grip and pull on the door handle. The door should not open.

The next time the door can only be unlocked via the remote control or the lock cylinder. The next time the door is locked/unlocked, Keyless Access will be active again.

Convenience functions

To close all the electric windows and the sunroof using the **convenience function**, keep a finger for a few seconds on the locking sensor surface  (arrow) of the door handle until the windows and roof have closed.

The **doors opened** by touching the sensor surface of the door handle depend on the settings that have been activated in the Easy Connect system with the  button and the

 and  function buttons.

ⓘ CAUTION

The sensor surfaces on the door handles could engage if hit with a water jet or high pressure steam if there is a valid vehicle key in the proximity. If at least one of the electric windows is open and the sensor surface  (arrow) on the handle is activated continuously, all windows will close.

ⓘ Note

- If the vehicle battery has little or no charge, or the vehicle key battery is almost or entirely out of charge, you will probably not be able to lock or unlock the vehicle with the Keyless Access system. The vehicle can be unlocked or locked manually.
- To control the proper locking of the vehicle, the release function is disabled for approx. 2 seconds.
- If the message **Keyless access system faulty** is displayed on the screen of the dash panel, abnormalities may occur in the operation of the Keyless Access system. Contact a specialised workshop. SEAT recommends visiting a SEAT dealership for this.
- Depending on the function set on the infotainment system for the mirrors, the exterior mirrors will unfold and the surround lighting will come on when unlocking the vehicle using the sensor surface on the driver door handle.

»

- If there is no valid key inside the vehicle or the system fails to detect one, a warning will display on the dash panel screen. This could happen if any other radio frequency signal interferes with the key signal (e.g. from a mobile device accessory) or if the key is covered by another object (e.g. an aluminium case).
- If the sensors are very dirty, e.g. have a layer of salt, the correct functioning of the sensors on the door handles may be affected. In this case, clean the vehicle.
- If the vehicle is equipped with an automatic gearbox, it may only be locked in the gear stick is in position P.

Childproof lock

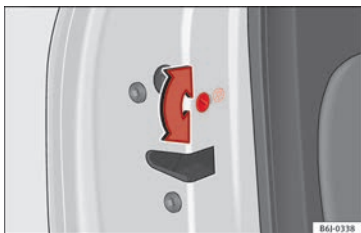

Fig. 145 Childproof lock on the left hand side door.

The childproof lock prevents the rear doors from being opened from the inside. This sys-

tem prevents minors from opening a door accidentally while the vehicle is running.

This function is independent of the vehicle electronic opening and locking systems. It only affects rear doors. It can only be activated and deactivated manually, as described below:

Activating the childproof lock

- Unlock the vehicle and open the door in which you wish to activate the childproof lock.
- With the door open, rotate the groove in the door using the ignition key, anti-clockwise for the left-hand side doors »» **Fig. 145** and clockwise for the right-hand side doors.

Deactivating the childproof lock

- Unlock the vehicle and open the door whose childproof lock you want to deactivate.
- With the door open, rotate the groove in the door using the ignition key, anti-clockwise for the right-hand side doors, and clockwise for the left-hand side doors »» **Fig. 145**.

Once the childproof lock is activated, the door can only be opened from the outside. The childproof lock can be activated or deac-

tivated by inserting the key in the groove when the door is open, as described above.

Anti-theft alarm*

Description of anti-theft alarm system*

The anti-theft alarm makes it more difficult to break into the vehicle or steal it. The system will initiate acoustic and optical warning signals when your vehicle is tried to be forced.

The anti-theft alarm system is automatically switched on when locking the vehicle. The system is immediately activated and the turn signal light located on the driver door will flash along with the turn signals, indicating that the alarm and the locking security system (double lock) have been turned on.

If any of the doors or the bonnet are open, they will not be included in the protection zones of the vehicle when the alarm is connected. If the door or the bonnet are subsequently closed, they will be automatically included in the protection areas of the vehicle and the turn signals will flash accordingly when the doors close.

- The turn signal light will flash twice on opening and deactivating the alarm.

- The turn signal light will flash once on closing and activating the alarm.

When does the system trigger an alarm?

The system triggers an alarm, if the following unauthorised actions are carried out when the vehicle is locked:

- Mechanical opening of the vehicle with the vehicle key without switching on the ignition in the next 15 seconds (in certain markets, such as the Netherlands, the alarm is activated immediately).
- A door is opened.
- Opening the bonnet.
- The rear lid is opened.
- Ignition switched on with a non-validated key.
- Movements in the driving compartment (vehicles with a volume sensor).
- Towing of the vehicle¹⁾.
- Vehicle tilt angle¹⁾.
- Undue manipulation of the alarm.
- Battery handling.

In this case, the acoustic signals will go off and the turn signal will flash for approximately 30 seconds. This cycle may be repeated up to 10 times depending on the country.

¹⁾ With vehicles fitted with a tow-away protection

Opening all the doors in manual mode

In vehicles without an alarm, when opening the driver door manually, all doors are opened.

How to switch the alarm off

To deactivate the anti-theft alarm, turn the key in the opening direction, open the door and switch the ignition on, or press the unlock button  on the remote control.

In vehicles equipped with an anti-theft alarm system, you have 15 seconds to insert the key in the ignition lock and activate the ignition if the vehicle is opened using the driver door key.

Otherwise, the alarm will trigger for 30 sec. and the ignition will be blocked.

Note

- **After 28 days, the indicator light will be switched off to prevent the battery from draining if the vehicle has been left parked for a long period of time. The alarm system remains activated.**
- **The alarm will trigger again if attempts are made to open another protection zone.**
- **The alarm system can be activated or deactivated using the radio frequency remote control » page 130.**

- **The anti-theft alarm is not activated when the vehicle is locked from within using the central locking button .**
- **If the vehicle battery is run down or flat then the anti-theft alarm will not operate correctly.**
- **Vehicle monitoring remains active even if the battery is disconnected or not working for any reason.**
- **The alarm is triggered immediately if one of the battery cables is disconnected while the alarm system is active.**

Vehicle interior monitoring and anti-tow system*

Monitoring or control function incorporated in the anti-theft alarm* which detects unauthorised vehicle entry by means of ultrasound.

Activation

- It is automatically switched on when the anti-theft alarm is activated.

Deactivation

- Open the vehicle with the key, either mechanically or by pressing the  button on the remote control. If the vehicle is opened »

mechanically, the time period from when the door is opened until the key is inserted into the contact should not exceed 15 seconds, otherwise the alarm will be triggered.

- Press the button  on the remote control twice. The volumetric sensor and tilt sensors will be deactivated. The alarm system remains activated.

The vehicle interior monitoring and the anti-tow system are automatically switched on again next time the vehicle is locked.

The vehicle interior monitoring and anti-tow sensor (tilt sensor) are automatically switched on when the anti-theft alarm is switched on. In order to activate it, all the doors and the rear lid must be closed.

If you wish to switch off the vehicle interior monitoring and the anti-tow system, it must be done each time that the vehicle is locked; if not, they will be automatically switched on.

The vehicle interior monitoring and the anti-tow system should be switched off if animals are left inside the locked vehicle (otherwise, their movements will trigger the alarm) or when, for example, the vehicle is transported or has to be towed with only one axle on the ground.

False alarms

Interior monitoring will only operate correctly if the vehicle is completely closed. Please observe related legal requirements.

The following cases may cause a false alarm:

- Open windows (partially or fully),
- Sliding sunroof open (partially or completely),
- Movement of objects inside the vehicle, such as loose papers, items hanging from the rear vision mirror (air fresheners), etc.



Note

- **If the vehicle is relocked and the alarm is activated without the volumetric sensor function, relocking will activate the alarm with all its functions, except the volumetric sensor. This function is reactivated when the alarm is switched on again, unless it is deliberately switched off.**
- **If the alarm has been triggered by the volumetric sensor, this will be indicated by a flashing of the warning lamp on the driver door when the vehicle is opened. The flash is different to the flash indicating the alarm is activated.**
- **The vibration of a mobile phone left inside the vehicle may cause the vehicle interior monitoring alarm to trigger, as both sensors react to movements and shakes inside the vehicle.**

• **If on activating the alarm, any door or the rear lid is open, only the alarm will be activated. The vehicle interior monitoring and the anti-tow system will only be activated once all the doors are closed (including the rear lid).**

Deactivating the vehicle interior monitoring and anti-tow system*

When the vehicle is locked, the alarm will be triggered if movements are detected in the interior (e.g. by animals) or if the vehicle's inclination is changed (e.g. during transport). You can prevent the alarm from being triggered accidentally by switching off the vehicle interior monitoring and/or tow-away protection.

- To switch off the interior monitoring and tow-away protection, switch off the ignition and, using the Infotainment system, select:  button >  function button > Opening and closing > Central locking > Switch off alarm.
- When the vehicle is locked now, the vehicle interior monitoring and the tow-away protection are switched off until the next time the door is opened.

If the anti-theft security system (Safelock)*
» page 133 is switched off, the vehicle interior monitoring and the tow-away protection are automatically switched off.

⚠ WARNING

Observe the safety warnings » ⚠ in Description on page 132.

Rear lid

Opening and closing

Read the additional information carefully

» 📖 page 16

⚠ WARNING

- Always close the rear lid properly. Risk of accident or injury.
- The rear lid must not be opened when the reverse or rear fog lights are lit. This may damage the tail lights.
- Do not close the rear lid by pushing it down with your hand on the rear window. The glass could smash. Risk of injury!
- Ensure the rear lid is locked after closing it. If not, it may open unexpectedly while driving.
- Never allow children to play in or around the vehicle. A locked vehicle can be subjected to extremely high and low temperatures, de-

pending on the time of year, thus causing serious injuries/illness. It could even have fatal consequences. Close and lock both the rear lid and all the other doors when you are not using the vehicle.

- Closing the rear lid without observing and ensuring it is clear could cause serious injury to you and to third parties. Make sure that no one is in the path of the rear lid.
- Never drive with the rear lid open or half-closed, exhaust gases may enter into the interior of the vehicle. Danger of poisoning!
- If you only open the rear lid, do not leave the key inside. The vehicle cannot be opened if the key is left inside.

Controls for the windows

Opening and closing of the electric windows*

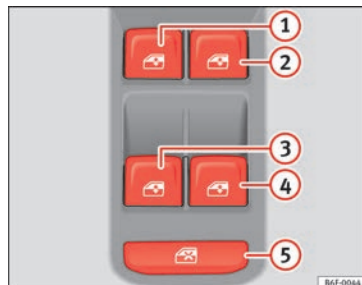

Fig. 146 Detail of the driver door: controls for the front and rear windows (vehicles with front and rear electric windows).

Read the additional information carefully

» 📖 page 18



The front and rear electric windows can be operated by using the controls on the driver door. The other doors each have a switch for their own window.

Always close the windows fully if you park the vehicle or leave it unattended » ⚠.

You can use the electric windows for approx. 10 minutes after switching off the ignition if »

neither the driver door nor the front passenger door has been opened and the key has not been removed from the ignition.

Safety switch *

The safety switch  **Fig. 146**  on the driver door can be used to disable the electric window buttons on the rear doors.

- *Safety switch not pressed:* buttons on rear doors are activated.
- *Safety switch pressed:* buttons on rear doors are deactivated. The safety control symbol  lights up in yellow if the buttons on the rear doors are switched off.

WARNING

Observe the safety warnings  in Set of keys on page 130.

- Incorrect use of the electric windows can result in injury.
- Never close the rear lid without observing and ensuring it is clear, to do otherwise could cause serious injury to you and third parties. Make sure that no one is in the path of a window.
- If the ignition is switched on, the electric equipment could be activated with risk of injury, for example, in the electric windows.
- The doors can be locked using the remote control key. This could become an obstacle for assistance in an emergency situation.

- Therefore always take the key with you when you leave the vehicle.
- The electric windows will work until the ignition has been switched off and one of the front doors has been opened.
- If necessary, use the safety switch to disable the rear electric windows. Make sure that they have been disabled.

Note

If the window is not able to close because it is stiff or because of an obstruction, the window will automatically open again  page 142. If this happens, check why the window could not be closed before attempting to close it again.

Roll-back function

The roll-back function reduces the risk of injury when the electric windows close.

- If a window is obstructed when closing automatically, the window stops at this point and lowers immediately .
- Next, check why the window does not close before attempting it again.
- If you try within the following 10 seconds and the window closes again with difficulty or there is an obstruction, the automatic closing will stop working for 10 seconds.

- If the window is still obstructed, the window will stop at this point.
- If there is no obvious reason why the window cannot be closed, try to close it again by pulling the tab within ten seconds. The window closes with maximum force. **The roll-back function is now deactivated.**

If more than 10 seconds pass, the window will open fully when you operate one of the buttons. One-touch closing is reactivated.



WARNING

- Always take the ignition key with you when leaving the vehicle, even if you only intend to be gone for a short time. Please ensure that children are never left alone inside the vehicle.
- The electric windows will work until the ignition has been switched off and one of the front doors has been opened.
- Closing the windows without observing and ensuring it is clear could cause serious injury to you and third parties. Make sure that no one is in the path of a window.
- Never allow people to remain in the vehicle when you close the vehicle from the outside. The windows cannot be opened even in an emergency.
- The roll-back function does not prevent fingers or other parts of the body getting pinched against the window frame. Risk of accident.



Convenience opening and closing

Use the convenience opening/closing function to easily open/close all the windows and the sliding/tilting sunroof* from the outside.

Convenience open function

- Press and hold the  button on the remote control key until all the windows and the sliding/tilting sunroof* have reached the desired position, or
- First unlock the vehicle using the  button on the remote control key and then keep the key in the driver door lock until all the windows and the sliding/tilting sunroof* have reached the required position.

Convenience close function

- Press and hold button  on the remote control key until all the windows and the sliding/tilting sunroof* are closed  , or
- Keep the key in the driver door in the "lock" position until all the windows and the sliding/tilting sunroof* are closed.

Programming convenience opening in the Easy Connect*

- Select:  button > **SETTINGS** function button > **Opening and closing** > **Electric windows** > **Convenience opening**, to choose between all the windows





(A11), only the driver's window (**Driver**) or none (**Deactivated**).

WARNING

- **Take care when closing the sliding/tilting sunroof* and windows. There is a risk of suffering injury.**
- **For safety reasons, you should only use the remote control open and close functions within about 2 metres of the vehicle. To avoid injuries, always keep an eye on the windows and the sliding/tilting sunroof* when pressing the button to close them. The windows stop moving as soon as the button is released.**

One-touch opening and closing*

One-touch opening and closing means you do not have to hold down the button.

Buttons  **Fig. 146** , ,  and  have two positions for opening windows and two for closing them. This makes it easier to open and close windows to the desired position.

One-touch closing

- Pull up the window button briefly up to the second position. The window closes fully.

One-touch opening

- Push down the window button briefly up to the second position. The window opens fully.

Resetting one-touch opening and closing

- The automatic open and close function will not work if the battery has been temporarily disconnected. The function can be restored as follows:
- Close the window as far as it will go by lifting and holding the electric window switch.
- Release the switch and then lift it again for 1 second. This will re-enable the automatic function.

If you push (or pull) a button to the first stage, the window will open (or close) until you release the button. If you push or lift the button briefly to the second stage, the window will open (one-touch opening) or close (one-touch closing) automatically. If you operate the button while the window is opening or closing, it stops at this position.

Sunroof*

Introduction

⚠ WARNING

If the sunroof is used negligently or without paying due attention, it can cause serious injury.

- Open or close the sunroof and the sun blind only when no one is in their path of movement.
- Never leave any key inside the vehicle when exiting.
- Never leave a child or any other person who may need help in the vehicle, especially if they have access to the vehicle key. If using they key unattended, they could lock the vehicle, start the engine, switch on the ignition and activate the sunroof.
- After switching off, it is still possible to open or close the sunroof during a short space of time provided that neither the driver nor passenger door is opened.

ⓘ CAUTION

- To prevent damage, during winter temperatures remove any ice or snow that might be on the car roof before opening the sunroof or adjusting the tilt position.
- Before leaving the vehicle or in case of rainfall, always close the sunroof. With the sunroof open or in a tilted position, water can en-

ter the interior and can cause considerable damage to the electrical system. As a result, other damage can occur in the vehicle.

ℹ Note

- Leaves and other loose objects that accumulate on the sunroof rails should be regularly cleaned away either by hand or with a vacuum.
- If the sunroof does not work correctly, the anti-trap function will not work either. Contact a specialised workshop.

Opening and closing the sunroof

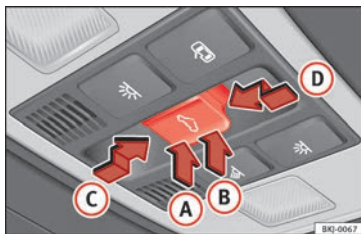

Fig. 147 On the interior roof lining: sunroof button.

The sunroof only works when the ignition is switched on. Once the ignition has been switched off, you can still open or close the sunroof for a few minutes provided the driver

door and the front passenger door are not opened.

The ⇐ button ⇨ **Fig. 147** has two levels. The first level switches the sunroof to the tilted position, opening or closing it fully or partially.

On the second level, the sunroof automatically moves to the corresponding final position after briefly pressing the button. Activating the button again stops the automatic function.

Adjusting the tilt position of the sunroof

- Press the rear part of the button **(B)** to the first level.
- Automatic operation: briefly press the rear part of button **(B)** to the second level.

Closing the sunroof from a tilted position

- Press the front part of the button **(A)** to the first level.
- Automatic operation: briefly press the front part of the button **(A)** to the second level.

Stopping the automatic operation by adjusting the tilted position of the sunroof or by closing the sunroof

- Press button **(A)** or **(B)** again.

Opening the sunroof

- Press button **C** backwards to the first level.
- Automatic operation to comfort position: briefly press button **C** backwards to the second level.

Closing the sunroof

- Press button **D** forwards to the first level.
- Automatic operation: briefly press button **D** forwards to the second level.

Stopping the automatic operation during the opening or closing

- Press button **C** or **D** again.

Sun blind

The sun blind is opened and closed manually (independently of the sliding sunroof).

Convenience function to open or close the sunroof*

The sunroof can be opened and closed with the convenience function, just like the windows:

*Using the door lock**

- Hold the key in the door lock of the driver door in either the unlocking or locking position to open or close the roof in the tilted position.

- Release the key to interrupt this function.

Using the remote control

- Keep the locking/unlocking button pressed to open/close the roof; if you stop pressing the button, the opening/closing function is stopped.

Once all the windows and the sunroof have closed, all the turn signals flash. During convenience closing, the windows and the sunroof close at the same time.

Anti-trap function of the panoramic sliding sunroof

The anti-trap function can reduce the risk of injury when closing the sunroof **»** **⚠**. If the sunroof encounters resistance or an obstacle when closing, it reopens immediately.

- Check why the sunroof did not close.
- Try to close the sunroof again.
- If the sunroof cannot be closed due to an obstacle or some resistance, it stops at the corresponding position and then reopens. For automatic closing, a new closing attempt might take place.
- If the sunroof is still unable to close, close it without the anti-trap function.

Closing the sunroof without the anti-trap function

- Before approx. 5 seconds of having activated the roll-back function, press the **↔** button **»** **Fig. 147** to the second level in the direction of arrow **»** **Fig. 147** **D** until the sunroof closes completely.
- **The sunroof closes without the anti-trap function intervening!**
- If the sunroof will still not close, visit a specialised workshop.

⚠ WARNING

Closing the sunroof without the anti-trap function can cause serious injuries.

- **Always be careful when closing the sunroof.**
- **No person should ever remain in the way of the sunroof, especially when closing without the anti-trap function.**
- **The anti-trap function does not prevent fingers or other parts of the body from becoming trapped against the roof frame and injuries occurring.**

Lights and visibility

Lights

Control lamps



It lights up

Rear fog light switched on » page 147.



It lights up

Left or right turn signal.
The control lamp flashes twice as fast when a turn signal is faulty.



It lights up

Main beam on or flasher on » page 147.

Several warning and control lamps light up for a few seconds when the ignition is switched on, signalling that the function is being verified. They will switch off after a few seconds.

WARNING

Observe the safety warnings » in Warning symbols on page 122.

Switching lights on and off

Read the additional information carefully
» page 31

The driver is personally responsible for the correct use and adjustment of the lights in all situations.

Note

- The legal requirements regarding the use of vehicle lights in each country must be observed.
- The dipped beam headlights will only work with the ignition on. The side lights come on automatically when the ignition is turned off.
- If the lights are left on after the key has been taken out of the ignition lock, an audible warning sounds while the driver door remains open. This is a reminder to switch the lights off.
- The use of the lighting described here is subject to the relevant statutory requirements.

Automatic lighting*

Activation

- Rotate the switch to the **AUTO** position, this indication will light up.

Deactivation

- Turn the light switch to **0**.

Automatic lighting

If automatic headlight control is switched on, dipped beam headlights are automatically switched on by a photosensor if you drive into a tunnel, for example.

WARNING

- Even if the automatic headlight control is switched on, the dipped beam headlights will not be switched on with fog. Therefore, the dipped beam must be switched on manually.

Note

- For vehicles with the automatic headlight system, when the key is removed from the ignition, the audible warning will only sound if the light knob is in position .
- The use of the lighting described here is subject to the relevant statutory requirements.
- Do not put stickers on the windscreen in front of the sensor. This may cause disruptions or faults in the automatic lighting system.
- The rain sensor switches on the dipped beam headlights when the windscreen wipers have been operating continuously for a few seconds and it switches the lights off when the continuous or interval wipe is switched off for some minutes.

Daytime running lights

The daytime running lights consist of individual lights, integrated in the front headlights. By connecting the daytime running lights, these lights are switched on¹⁾ » » ⚠.

The daytime running lights switch on every time the ignition is switched on, if the switch is in positions **0** or **AUTO**, according to the level of exterior lighting.

When the light switch is in position **AUTO**, a light sensor automatically switches dipped beam on and off (including the control and instrument lighting) or the daytime running lights depending on the level of exterior lighting.

⚠ WARNING

- Never drive with daytime lights if the road is not well lit due to weather or lighting conditions. Daytime lights do not provide enough light to illuminate the road properly or be seen by other road users.
- On vehicles with rear lights with bulbs, when activating the daytime running light the rear lights are not switched on. A vehicle which does not have the rear lights on may not be visible to other drivers in the darkness, in the case of heavy rain or in conditions of poor visibility.

¹⁾ On vehicles equipped with rear LED lights, the rear side light is switched on as well.

Fog lights



Fig. 148 Dash panel: light control.

Switching on the front fog lights*

- Pull the light switch to the first point » » Fig. 148 ①, from positions ☾ , ☽ or **AUTO**. The symbol ☾ in the light switch lights up.

Switching on the rear fog light (vehicles with front fog lights)

- Completely pull the light switch ② from position ☾ , ☽ or **AUTO**. The ☾ lamp on the instrument panel lights up.

Switching on the rear fog light (vehicles with no front fog lights)

- Completely pull the light switch ② from position ☾ , ☽ or **AUTO**. This type of switch

only has one position. The ☾ lamp on the instrument panel lights up.

Turn signal and main beam lever

Read the additional information carefully » » 📖 page 32

Parking lights

- Switch the ignition off and remove the key from the lock.
- Move the turn signal lever up or down to turn the right or left-hand parking lights on, respectively.

Convenience turn signals

For the one-touch signalling, when the ignition is switched on, move the lever as far as possible upwards or downwards and release the lever. The turn signal will flash three times.

One-touch signalling is activated and deactivated in the Easy Connect system via the **CAR** button and the function button **SETTINGS > Lights > One-touch signalling** » » 📖 page 34. » »



In vehicles that do not have the corresponding menu, this function can be deactivated in a specialised workshop.

⚠ WARNING

The main beam can dazzle other drivers. Risk of accident! Never use the main beam headlights or the headlight flasher if they could dazzle other drivers.

i Note

- If the convenience turn signals are operating (three flashes) and the other convenience turn signals are switched on, the active part stops flashing and only flashes once in the new part selected.

- The *turn signals* only work when the ignition is switched on. The corresponding warning lamp  flashes in the instrument panel. The control lamp  flashes when the turn signals are operated, provided a trailer is correctly attached and connected to the vehicle. If a turn signal bulb is defective, the control lamp flashes at double speed. If the trailer turn signal bulbs are defective, the control lamp  does not light up. Change the bulb.

- The *main beam headlights* can only be switched on if the dipped beam headlights are already on. The warning lamp  then comes on in the instrument panel.

- The *headlight flasher* comes on for as long as you pull the lever – even if no other lights are switched on. The warning lamp  then comes on in the instrument panel.

- When the *parking lights* are switched on, the headlight and the tail light on the corresponding side of the vehicle light up. The parking lights will only work with the ignition off. If said light is on, an audible warning will be emitted while the driver door is open.

- If the turn signal lever is left on after the key has been taken out of the ignition lock, an acoustic signal sounds when the driver door is opened. This is intended as a reminder to switch off the turn signal, unless you wish to leave the parking light on.

Coming Home/Leaving Home Function*



|BKJ-0097

Fig. 149 Related video

The Leaving Home function is controlled with a photosensor.

If the Coming Home or Leaving Home function is connected, the front side and dipped lights, the tail lights and the number plate light will light up to provide assistance.

Coming home function

The Coming Home function is activated by switching off the ignition. When the driver door is opened, the Coming Home lighting comes on.

The Coming Home lighting switches off in the following cases:

- If, 30 seconds after being connected, any doors or the rear lid remain open.
- If the light switch is turned to position 0.
- If the ignition is switched on.

Automatic Leaving Home function

The Leaving Home function is activated when the vehicle is unlocked if:

- the light control is in position **AUTO** and
- the photosensor detects “darkness”.

The Leaving Home lighting switches off in the following cases:

- If the time period for the delay in switching off the headlights has ended
- If the vehicle is locked again.
- If the light switch is turned to position 0.
- If the ignition is switched on.

Note

• To activate the Coming/Leaving home function, the rotary light switch must be in position AUTO and the light sensor must detect darkness.

Fog lights with cornering function*

This is an additional light source to dipped beam headlights to light up the road as a bend is taken.

The cornering light operates with the lights switched on and when driving at less than 40 Km/h (25 mph). Ignition occurs by turning the steering or connecting the turn signal.

Forward gear

- If the steering wheel is turned to the right, or the right-hand turn signal operated, the right-hand fog light turns on.
- If the steering wheel is turned to the left, or the left-hand turn signal operated, the left-hand fog light turns on.

In reverse, both fog lights turn on.

Note

When the fog lamps are on, the cornering function is activated and both headlights are continuously on.

Motorway light*

The motorway light is available on vehicles equipped with full-LED lights.

The function is connected/disconnected via the corresponding Easy Connect system menu.

- **Activation:** when going above 110 km/h (68 mph) for more than 10 seconds, the dipped beam raises slightly to increase the driver's visibility distance.
- **Deactivation:** when reducing the speed of the car below 100 km/h (62 mph), the dipped beam returns to its normal position.

Headlight range control



Fig. 150 Dash panel: headlight range control.

The lights range control adapts according to the value of the headlight beam and the ve-

hicle load status. This offers the driver optimum visibility and the headlights do not dazzle oncoming drivers »» **△**.

The headlights can only be adjusted when the dipped beam is switched on.

To reset, turn switch »» **Fig. 150:**

Value	Vehicle load status ^{a)}
-	Two front occupants, luggage compartment empty
1	All seats occupied, luggage compartment empty
2	All seats occupied, luggage compartment full. With trailer and minimum drawbar load.
3	Driver only, luggage compartment full With trailer and maximum drawbar load.

^{a)} If the vehicle load does not correspond to those shown in the table, it is possible to select intermediary positions.

Dynamic headlight range control

The control is not mounted in vehicles with dynamic headlight range control. The headlight range is automatically adjusted according to the vehicle load status when they are switched on.



⚠ WARNING

Heavy objects in the vehicle may mean that the headlights dazzle and distract other drivers. This could result in a serious accident.

- Adjust the light beam to the vehicle load status so that it does not blind other drivers.

Hazard warning lights ⚠



Read the additional information carefully

»  page 32

The hazard warning lights are used to draw the attention of other road users to your vehicle in emergencies.

If your vehicle breaks down:

1. Park your vehicle at a safe distance from moving traffic.
2. Press the button to switch on the hazard warning lights » .
3. Switch the ignition off.
4. Apply the handbrake.
5. For a manual gearbox, engage 1st gear; for an automatic gearbox, move the gear lever to **P**.
6. Use the warning triangle to draw the attention of other road users to your vehicle.
7. Always take the vehicle key with you when you leave the vehicle.

All turn signals flash simultaneously when the hazard warning lights are switched on. The two turn signal turn signal lamps   and the turn signal lamp in the switch  will flash at the same time. The simultaneous hazard warning lights also work when the ignition is switched off.

⚠ WARNING

- The risk of an accident increases if your vehicle breaks down. Always use the hazard warning lights and a warning triangle to draw the attention of other road users to your stationary vehicle.

- Due to the high temperatures that the catalytic converter can reach, never park in an area where the catalytic converter could come into contact with highly inflammable materials, for example dry grass or spilt petrol. This could start a fire.



i Note

- The battery will run down if the hazard warning lights are left on for a long time, even if the ignition is switched off.
- The use of the hazard warning lights described here is subject to the relevant statutory requirements.

Interior lights**Related video**

Fig. 151 Convenience

Lighting of instruments and controls

The lighting level of instruments, controls and displays can be adjusted through the Easy Connect system using the  button and the  function button »  page 34.

The instrument lighting (some dials and needles), the centre console lighting and the lighting of the displays are regulated by a photodiode incorporated in the instrument panel.

The instrument lighting (needles) is switched on when the ignition is on and the **light is off**. The instrument lighting is dimmed automatically as the daylight starts to fade. It goes out completely when ambient light is very low. This function is intended to remind the driver to switch on the dipped beam

headlights in good time when light conditions become poor.

Interior and reading lights



Read the additional information carefully
»  page 33



Luggage compartment lighting

The light is activated when the rear lid is open, even when the ignition and lights are turned off. For this reason, ensure that the rear lid is always closed.

Ambient light*

The ambient light lights up the area of the centre console and the footwell area and, depending on the version, the front door panels as well.

It will be switched on at full brightness when the doors are opened and the lights will be dimmed during driving, when the light selector is in the ,  or **AUTO** position.

The brightness of the ambient light* can be adjusted through the Easy Connect menu, as can colour, in versions with lighting on the front door panel (the ) button and the function button **SETTINGS > background lighting** »  page 34).

Note

If not all the vehicle doors are closed, the interior lights will be switched off after approx. 10 minutes, providing the ignition key has been removed and the courtesy light position selected. This prevents the battery from discharging.

Visibility

Heated rear window

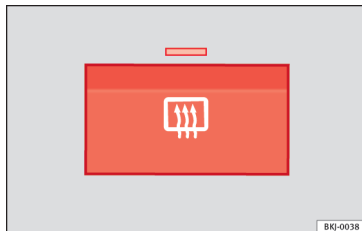

Fig. 152 With the air conditioning controls: heated rear window switch.

The heated rear window only works when the engine is running. When it is switched on, a lamp lights up on the switch.

After approximately 8 minutes, the heating device of the rear window switches off automatically.

For the sake of the environment

The heated rear window should be switched off as soon as the glass is demisted. By saving electrical power you can also save fuel.

Note

To avoid possible damage to the battery, an automatic temporary disconnection of this function is possible, coming back on when normal operating conditions are re-established.

Sun visors

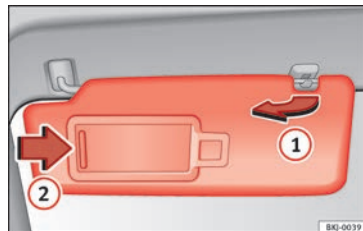

Fig. 153 Sun visor on the driver side.

Options for adjusting driver and front passenger sun visors:

- Lower the sun visor towards the windscreen.

»

- The sun visor can be pulled out of its mounting and turned towards the door »» Fig. 153 ①.
- Swing the sun visor towards the door, longitudinally backwards.

Vanity mirror

There is a vanity mirror, with a cover ②, on the rear of the sun blind.

WARNING

Folded sun blinds can reduce visibility.

- Always store sun blinds and visors in their housing when not in use.

Windscreen wiper and rear window wiper systems

Windscreen wiper and window wiper

Read the additional information carefully

»»  page 33

WARNING

- Worn and dirty wiper blades reduce visibility and safety levels while driving.
- In cold conditions you should not use the wash/wipe system unless you have warmed the windscreen with the heating and ventilation system. The windscreen washer fluid

could otherwise freeze on the windscreen and obscure your view of the road.

- Always note the corresponding warnings »»  page 73.

WARNING

The rain sensor* may not detect enough rain to switch on the wipers.

- If necessary, switch on the wipers manually when water on the windscreen obstructs visibility.

CAUTION

In icy conditions, always check that the windscreen wipers and the window wiper are not frozen. If you switch on the windscreen wipers when the wiper blades are frozen to the windscreen, you could damage both the wiper blades and the wiper motor.

Note

- The wipers and washers will work only when the ignition is switched on.
- The heat output of the heated jets* is controlled automatically when the ignition is switched on, depending upon the outside temperature.
- In certain versions of vehicles with alarms, the windscreen wiper will only work in interval/rain sensor mode when the ignition is on and the bonnet closed.

• When the interval wipe function is on, the intervals are directly proportional to the speed. This way, the higher the vehicle speed the shorter the intervals.

• If you stop the vehicle with the windscreen wiper in position 1 or 2, it will automatically change to a lower position speed. The set speed will be resumed when the vehicle pulls away.

• The windscreen will be wiped again after approximately five seconds once the “automatic wash/wipe system” has been activated, provided the vehicle is moving (drip function). If you activate the wipers less than 3 seconds after the drip function, a new wash sequence will begin without performing the last wipe. For the “drip” function to work again, you have to turn the ignition off and then on again.

• Do not put stickers on the windscreen in front of the rain sensor*. This may cause sensor disruption or faults.

• Depending on the version of the model, when you engage reverse gear and with the headlight wiper activated, this can start a wipe.

Rear view mirrors

Interior mirror

It is dangerous to drive if you cannot see clearly through the rear window.

Interior mirror with automatic anti-dazzle function*

The anti-dazzle function is activated every time the ignition is switched on.

When the anti-dazzle function is enabled, the interior rear vision mirror will darken **automatically** according to the amount of light it receives. The anti-dazzle function is cancelled if reverse gear is engaged.

Note

- The automatic anti-dazzle function will only work properly if the sun blind* for the rear window is retracted and there are no other objects preventing light from reaching the interior rear vision mirror.
- If you have to stick any type of sticker on the windscreen, do not do so in front of the sensors. Doing so could prevent the anti-dazzle function from working well or even from working at all.

Folding in the exterior mirrors manually

The exterior mirrors of the vehicle may be folded in. For this, press the mirror housing towards the vehicle.

Note

Before washing the vehicle with an automatic car wash, fold in the exterior mirrors to avoid damage.

Electric exterior mirrors*

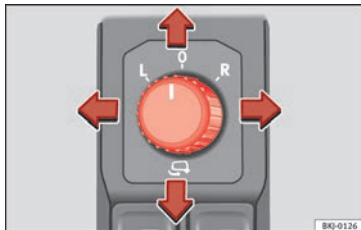

Fig. 154 Exterior mirror controls.

Read the additional information carefully

» page 20

The exterior mirrors can be adjusted using the rotary knob in the driver door.

Basic setting of exterior mirrors

1. Turn knob » Fig. 154 to position **L** (left exterior mirror).
2. Turn the rotary knob to position the exterior mirror so that you have a good view to the rear of the vehicle.

3. Turn the knob to position **R** (right exterior mirror).
4. Swivel the rotary knob to position the exterior mirror so that you have a good view to the rear of the vehicle » .

Heated exterior mirrors*

- Press the demisting button » Fig. 152
- The mirrors demist for some minutes to prevent draining the battery unnecessarily.
- If necessary, press the button again to repeat the function.
- The exterior mirror heating is not activated in temperatures above approximately +20°C (+68°F).

Folding in the exterior mirrors electrically*

- Turn the control » Fig. 154 to position to fold in the exterior mirrors. You should always fold in the exterior mirrors if you are driving through an automatic car wash. This will help prevent damage.

Folding exterior mirrors back out to the extended position*

- Turn the knob to position **L** or **R** to return the exterior mirrors to their original position » .

Fold in the exterior mirrors after parking (convenience function)*

The Easy Connect system, the **CAR** button and the function buttons **SETTINGS** and **Mirrors and windscreen wipers** can be used to have the exterior mirrors fold in when the vehicle is parked » page 123.

When the vehicle is locked with the remote control, by pressing for more than approximately 1 second the exterior mirrors are folded in automatically. When the vehicle is opened with the remote control, the exterior mirrors are deployed automatically.

WARNING

- Convex or aspheric mirrors increase the field of vision however the objects appear smaller and further away in the mirrors. If you use these mirrors to estimate the distance to vehicles behind you when changing lane, you could make a mistake. Risk of accident.
- If possible, use the rear vision mirror to estimate distances to vehicles behind you.
- Make sure that you do not get your finger trapped between the mirror and the mirror base when folding back the mirrors. Risk of injury!

For the sake of the environment

The exterior mirror heating should be switched off when it is no longer needed. Otherwise, it is an unnecessary fuel waste.

Note

- If the electrical adjustment ever fails to operate, the mirrors can be adjusted by hand by lightly pressing the edge of the mirror glass.
- In vehicles with electric exterior mirrors, the following points should be observed: if, due to an external force (e.g. being knocked while manoeuvring), the adjustment of the mirror housing is altered, the mirror will have to be fully folded electrically. Do not readjust the rear vision mirror housing by hand, as this will interfere with the mirror adjuster function.
- The fold-in function on the exterior mirrors will not activate at speeds over 40 km/h (25 mph).

Seats and head restraints

Adjusting the seat and head restraints

Adjusting the front seats

Read the additional information carefully »  page 19

WARNING

The safe driving chapter contains important information, tips, suggestions and warnings that you should read and observe for your own safety and the safety of your passengers » page 75.

WARNING

- Never adjust the driver or front passenger seat while the vehicle is in motion. While adjusting your seat, you will assume an incorrect sitting position. Risk of accidents. Adjust the driver or front passenger seat only when the vehicle is stationary.
- To reduce the risk of injury to the driver and front passenger in case of a sudden braking or an accident, never drive with the backrest tilted towards the rear. The maximum protection of the seat belt can be achieved only when the backrests are in an upright position and the driver and front passenger have properly adjusted their seat belts. The further the

backrests are tilted to the rear, the greater the risk of injury due to improper positioning of the belt web!

- Exercise caution when securing the seat height into forwards/backwards position. Injuries can be caused if the seat height is adjusted without due care and attention.
- To move the seat forwards and backwards, pull upwards and not sideways on the lever, as the force exerted on it in that direction could damage it.

Adjusting the front head restraints

Read the additional information carefully
»  page 19

Adjust the head restraint »  page 19 so that as far as possible the top of the head restraint is level with the top of your head. When this is not possible, try to get as close as possible to this position.

WARNING

- Never drive if the head restraints have been removed. Risk of injury.
- After refitting the head restraint, you must always adjust it properly for height to achieve optimal protection.
- Please observe the safety warnings »  in Correct adjustment of front head restraints on page 79.

Note

- When fitting the head restraints again, insert the tubes as far as possible into the guides without pressing the button.

Adjustment of the rear head restraints

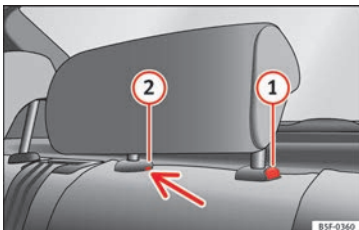





Fig. 155 Rear centre head restraint: release point.

When transporting people in the back seat, place the head restraints of the occupied seats at a minimum of the next socket up » .





Adjusting the head restraints

- To set the head restraint higher, grasp the sides with both hands and move it upwards, until you see it engage.

- To set the head restraint lower down, press the »  Fig. 155  button and move it downwards.



Removing the head restraint

To remove the head restraint, the corresponding backrest must be partially folded forward.

- Unlock the backrest »  page 157.
- Move the head restraint upwards until it arrives to the top.
- Press button , while simultaneously pressing on the security hole  with a flat screwdriver a maximum of 5 mm wide, and remove the head restraint.
- Move the backrest until it engages properly » .

Fitting the head restraint

To mount the external head restraints, the corresponding backrest must be partially folded forward.

- Unlock the backrest »  page 157.
- Insert the head restraint bars into the guides until they perceptibly engage. It should not be possible to remove the head restraint from the backrest.
- Move the backrest until it engages properly » .

⚠ WARNING

- Please observe the general notes »» page 79.
- Remove the rear head restraints only when it is necessary for the placement of a child seat »» page 92. After removing a child seat, remount the head restraint immediately. Travelling with the head restraints removed or improperly adjusted increases the risk of severe injuries.

Seat functions

Introduction

⚠ WARNING

Inappropriate use of the seat functions can cause severe injuries.

- Assume the proper sitting position before your trip and remain in it throughout. This also applies to the other occupants.
- Always keep hands, fingers, feet and other parts of the body away from the operating radius and the adjustment of seats.

Heated seats*

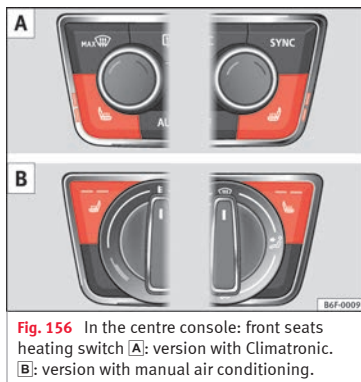

Fig. 156 In the centre console: front seats heating switch **A**: version with Climatronic. **B**: version with manual air conditioning.

The seat cushions can be heated electrically when the ignition is switched on. The backrest is also heated in some versions.

The seat heating should not be engaged in any of the following conditions:

- The seat is unoccupied.
- The seat has a covering.
- There is a child seat installed in the seat.
- The seat cushion is wet or damp.
- The indoor or outdoor temperature is greater than 25°C (77°F).

Activate

Press the button or . Seat heating is switched on fully.

Adjusting the heating output

Press the button or repeatedly until the desired temperature is reached.

Deactivating

Press the button or until all the warning lamps switch off.

⚠ WARNING

Children and people who cannot perceive pain or temperature because of medications, paralysis or chronic diseases (e.g. diabetes) or have a limited perception of these, may suffer burns to the back, buttocks or legs when using seat heating, an occurrence that may entail a very lengthy recovery period or from which it may not be possible to recover fully. Seek medical advice if you have doubts regarding your health.

- People with limited pain and temperature thresholds must never use seat heating.
- If an abnormality in the device's temperature control is detected, have it checked by a specialist workshop.

⚠ WARNING

If the fabric of the cushion is wet, this can adversely affect the operation of the seat heating, increasing the risk of burns.

- Make sure the seat cushion is dry prior to using the seat heater.
- Do not sit on the seat with clothing that is wet or damp.
- Do not leave clothing that is wet or damp on the seat.
- Do not spill liquid on the seat.

ⓘ CAUTION

- To avoid damaging the heating elements of the seat heaters, please do not kneel on the seat or apply sharp pressure to a single point on the seat cushion or backrest.
- Liquids, sharp objects and insulating materials (e.g. covers or child seats) can damage the seat heating.
- In the event of smells, switch off the seat heating immediately and have it inspected by a specialised workshop.

♻ For the sake of the environment

The seat heating should remain on only when needed. Otherwise, it is an unnecessary fuel waste.

Folding down the back seat

Fig. 157 Folding up the rear seat cushion.

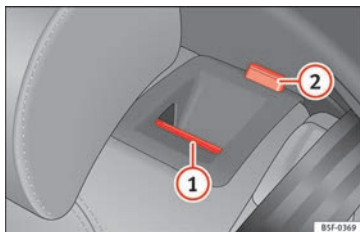

Fig. 158 On the rear seat backrest: unlock button ①; red mark ②.

Folding seat down

- Remove the head restraint » page 155.
- Pull the front edge of the seat cushion » Fig. 157 ① upwards in the direction of the arrow.

- Lift the cushion ② forwards in the direction of the arrow.
- Press the unlock button » Fig. 158 ① forwards and at the same time fold the backrest down. The rear seat backrest is not engaged when the red marking of the button ② is visible.
- Insert the head restraints in the spaces on the rear of the seat cushion which are visible when the seat cushion is lowered.

Folding seat forward

- Remove the head restraints from the spaces in the seat cushion.
- Lift the backrest, and before securing it, replace the head restraints in the seat cushion, and then click the seat correctly onto the locking rails. The red marking on the tab ② should no longer be visible when the backrest is properly secured.
- Lower the cushion and push it backwards below the seat belt buckles.
- Press the front part of the cushion downwards.

On split rear seats*, the backrest and cushion can be lowered and raised respectively in two sections. »

⚠ WARNING

- Please be careful when folding back the backrest! Injuries can be caused if the seat height is adjusted without due care and attention.
- Do no trap or damage seat belts when raising the backrest.
- After raising the backrest, check it has engaged properly in position. Do this by pulling on the central seat belt or directly on the backrest and check that the position lever is in the neutral position.
- The three point automatic seat belt only works correctly when the backrest of the central seat is correctly engaged.

Transport and practical equipment

Practical equipment

Glove compartment



Fig. 159 Passenger side: glove compartment.

The compartment can be opened by pulling the lever »» Fig. 159.

This compartment can hold documents in A4 format, a water bottle of 1.5 L, etc.

Depending on the vehicle equipment, the CD player is located in the glove compartment. Separate operating instructions are enclosed for this equipment in the corresponding Instruction Manual.

⚠ WARNING

Always keep the storage compartment cover closed while the vehicle is in motion in order to reduce the risk of injury caused by a sudden braking or by an accident.

Storage compartment under the front seats*



Fig. 160 Storage compartment under the right front passenger seat.

To open

- The compartment is opened by pulling on the lever and guiding it with your hand.

To close

- Press the cover inwards until the closed drawer “clicks” into position.

Note

The storage drawer will hold a maximum weight of 1.5 kg.

Storage pocket in the seat*

Fig. 161 Storage pocket.

There is a storage pocket on the rear of the front seats.

Storage compartment in front door panel*

In this storage compartment a 1.5l water bottle, etc. can be stored.

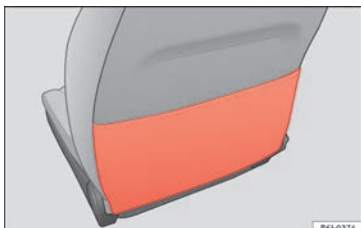
Front drink holder*

Fig. 162 Front drink holders in the centre console.

In the central console, next to the hand brake, there are two drinks holders

»» **Fig. 162.**

⚠ WARNING

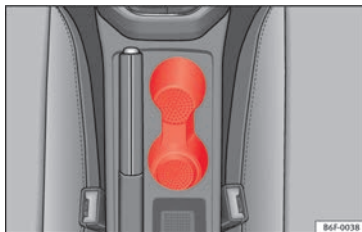
- Do not put hot drinks in the drink holders. During sudden or normal driving manoeuvres, when braking suddenly or in case of an accident, the hot drink could spill. Risk of scalding.
- Never use rigid materials (for example, glass or ceramic), since they could cause injury in the case of an accident.
- When travelling, the drinks holder should always be closed to prevent risk in the event of sudden braking or accident.

Front ashtray*

Fig. 163 Ashtray in the centre console.

Opening and closing the ashtray

- To open the ashtray, lift the cover
- »» **Fig. 163.**
- To close, push the cover down.

Emptying the ashtray

- Extract the ashtray and empty it.

⚠ WARNING

Never put paper in the ashtray. Hot ash could ignite the paper in the ashtray and cause a fire.

Electrical power socket

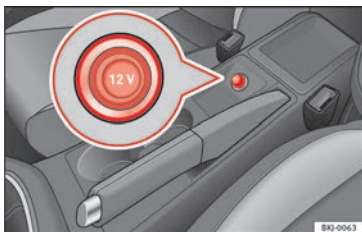

Fig. 164 Front power socket.

The 12 Volt cigarette lighter power socket can also be used for other electrical components with a power rating of up to 120 Watt. When the engine is switched off, however, the vehicle battery will discharge. For further information see »» page 247.

⚠ WARNING

The power sockets and the connected accessories will only operate when the ignition is on or when the engine is running. Improper use of the sockets or electrical accessories can lead to serious injuries or cause a fire. To avoid the risk of injury, never leave children alone inside the vehicle.

ⓘ CAUTION

Always use the correct type of plugs to avoid damaging the sockets.

ⓘ Note

- The use of electrical appliances with the engine switched off will cause a battery discharge.
- Before using any electrical accessories, see the instructions in »» page 247.

Cigarette lighter*

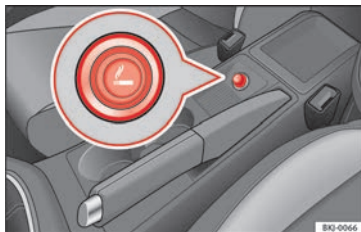

Fig. 165 Lighter.

- Press on the cigarette lighter »» Fig. 165 to activate it »» ⚠.
- Wait for the lighter to spring out.
- Pull out the cigarette lighter and light the cigarette on the glowing coil.

⚠ WARNING

- Improper use of the cigarette lighter can lead to serious injuries or start a fire.

- Using the lighter carefully. Carelessness or negligence when using the cigarette lighter can cause burns and serious injuries.
- The lighter only works when the ignition is turned on or the engine is running. To avoid the risk of fire, never leave children alone inside the vehicle.

Luggage compartment

Loading the luggage compartment

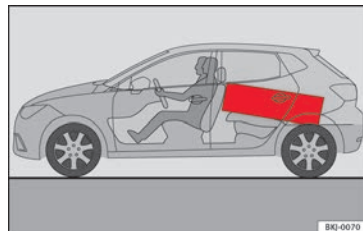

Fig. 166 Position heavy items as far forward as possible.

All luggage and other loose objects must be safely secured in the luggage compartment. Unsecured objects which shift back and forth could affect safety or driving characteristics of the vehicle by shifting the centre of gravity.

- Distribute the load evenly in the luggage compartment.
- Place heavy objects as far forward as possible in the luggage compartment
»» Fig. 166.
- Place the heavy objects first.
- Secure heavy objects to the fitted fastening rings* »» page 162.
- Secure loose loads with a luggage net* or with non-elastic straps secured to the fastening* rings.

WARNING

- Loose luggage and other objects in the luggage compartment could cause serious injuries.
- Always stow objects in the luggage compartment and secure them with the fastening rings*.
- During sudden manoeuvres or accidents, loose objects can be thrown forward, injuring vehicle occupants or even third parties. This increased risk of injury will be further increased if a loose object is struck by an inflating airbag. If this happens, objects may shoot outward like a missile. Risk of fatal injury.
- Always keep all objects in the luggage compartment and use appropriate grips to secure them, particularly in the case of heavy objects.

- Never exceed the allowed axle weights or allowed maximum weight. If said weights are exceeded, the driving characteristics of the vehicle may change, leading to accidents, injuries and damage to the vehicle.
- Please note that the centre of gravity may shift when transporting heavy objects; this may affect vehicle handling and lead to an accident. Therefore, it is essential to adjust your speed and driving style accordingly, to avoid accidents.
- Never leave your vehicle unattended, especially when the rear lid is open. Children could climb into the luggage compartment, closing the door behind them; they will be trapped and run the risk of death.
- Never allow children to play in or around the vehicle. Close and lock all the doors and the rear lid when you leave the vehicle. Before you lock the vehicle, make sure that there are no adults or children in the vehicle.
- Please observe the notes on the »» page 75.

CAUTION

Hard objects on the rear shelf could chafe against the wires of the heating element in the heated rear window and cause damage.

Note

- The tyre pressure must be adjusted according to the load. When necessary, check the tyre pressures on the adhesive label stuck to

the back of the front left door frame
»» page 275.

- Air circulation in the vehicle helps reduce fogging of the windows. Used air escapes through ventilation slits in the side trim of the luggage compartment. Ensure that the ventilation slots are never covered.
- Straps for securing the load to the fastening rings* are commercially available from accessory shops.

Rear shelf

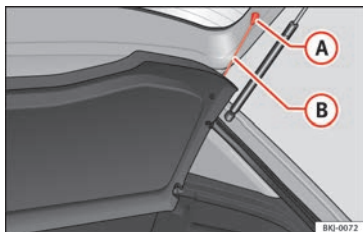

Fig. 167 In the luggage compartment: removing and installing the rear shelf.

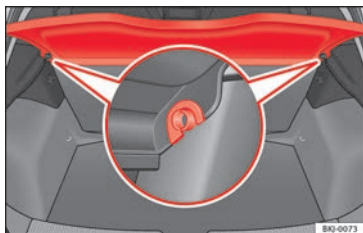

Fig. 168 In the luggage compartment: removing and installing the rear shelf.

Removing

- Detach the cord loops » **Fig. 167** **(B)** from their hooks **(A)**.

- Remove the rear shelf from the side supports » **Fig. 168** by pulling it upwards and then take it out.

If necessary, the rear shelf can be stored under the luggage compartment double floor » **page 163**.

Fitting

- Insert the cover horizontally so that the “recess” fits onto the axis of the supports » **Fig. 168** and press down until it engages.
- Hook the loops » **Fig. 167** **(B)** to the rear lid.

⚠ WARNING

Do not place heavy or hard objects on the rear shelf, because they will endanger the vehicle occupants in case of sudden braking.

ⓘ CAUTION

- Before closing the rear lid, ensure that the rear shelf is correctly fitted.
- An overloaded luggage compartment could mean that the rear shelf is not correctly seated and it may be bent or damaged.
- If the luggage compartment is overloaded, remove the tray.

i Note

- Ensure that, when placing items of clothing on the luggage compartment cover, rear visibility is not reduced.

Fastening rings*

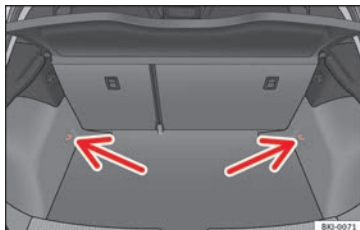

Fig. 169 Location of fastening rings in luggage compartment.

There may be some fastening rings included in the luggage compartment for fastening luggage and other objects » **Fig. 169** (arrows).

- Always use suitable and undamaged straps to secure luggage and other objects to the fastening rings » **⚠** in Loading the luggage compartment on **page 161**.

Example: An object weighing 4.5 kg is lying unsecured in the vehicle. During a frontal collision at a speed of 50 km/h (31 mph), this

object generates a force corresponding to 20 times its weight. That means that the effective weight of the object increases to approximately 90 kg. You can imagine the severity of the injuries which might be sustained if this “object” strikes an occupant as it flies through the interior of the vehicle. This increased risk of injury will be further increased if a loose object is struck by an inflating air-bag.

⚠ WARNING

- If pieces of baggage or other objects are secured to the fastening rings with inappropriate or damaged retaining cords, injuries could result in the event of braking manoeuvres or accidents.
- Never secure a child seat on the fastening rings.

Luggage compartment variable floor

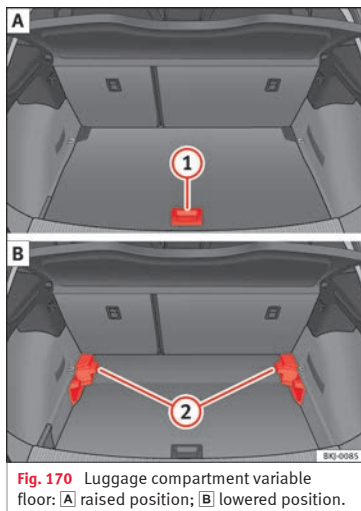

Variable floor in the high position

- Lift the floor using handle »» Fig. 170 ① and pull it back until the front of the floor has fully passed the supports ②.
- Move the floor forward over the supports as far as the rear seat backrest and then lower the floor with the handle ①.

Variable floor in the low position

- Lift the floor using handle ① and pull it back until the supports ② have fully passed the front part of the floor.
- Now match the front part with the lower grooves of the supports and slide the floor forwards as far as the rear seat backrest and lower the floor at the same time with the handle ①.

Variable floor in the tilted position

When the variable floor is tilted you can access the spare wheel/anti-puncture kit area.

- Lift the variable floor in the high position using handle ①, pull it up and push it towards the backrest of the rear seats until the floor folds along the hinge line and the movable part of the floor is resting on itself.
- Rest the floor on its housings »» Fig. 171 (arrows).

⚠ WARNING

During a sudden driving or braking manoeuvre, or in the event of an accident, objects could be flung through the interior and cause serious or fatal injuries.

- Always secure objects, even when the luggage compartment floor is properly lifted.
- Only objects that do not protrude more than 2/3 the height of the floor may be carried between the rear seat and the raised luggage compartment floor.
- Only objects that do not weigh than approximately 7.5 kg may be carried between the rear seat and the raised luggage compartment floor.

ⓘ CAUTION

- The maximum weight that can be loaded on the luggage compartment variable floor in the top position is 150 kg.

- Do not let the luggage compartment floor fall when closing it. Always carefully guide it downwards in a controlled manner. Otherwise, the lining and the floor of the luggage compartment could be damaged.

ⓘ Note

SEAT recommends the use of straps to secure objects to retaining rings.

Roof carrier*

Introduction

The vehicle roof has been designed to optimise aerodynamics. For this reason, cross bars or conventional roof carrier systems cannot be secured to the roof water drains.

As the roof water drains are integrated in the roof to reduce air resistance, only SEAT-approved cross bars and roof carrier systems can be used.

Cases in which cross bars and the roof carrier system should be disassembled.

- When they are not used.
- When the vehicle is washed in a car wash.
- When the vehicle height exceeds the maximum height, for example, in some garages.

⚠ WARNING

When heavy or bulky loads are transported on the roof carrier system, car driving performance is affected, as the centre of gravity shifts and there is greater wind resistance.

- Always secure the load properly using belts or retaining straps that are suitable and in a good condition.
- Bulky, heavy, long or flat loads have a negative effect on aerodynamics, the centre of gravity and driving performance.
- Avoid sudden braking and manoeuvres.
- Adapt your speed and driving style at all times to suit visibility, weather, road and traffic conditions.

ⓘ CAUTION

- Remove the cross bars and the roof carrier system before entering a car wash.
- Vehicle height is increased by the installation of cross bars or a roof carrier system and the load secured on them. For this purpose, check that your vehicle's height does not surpass the headspace limit, for example, for underpasses or for entering garage doors.
- Cross bars, a roof carrier system and the load secured on them should not interfere with the roof aerial or hamper the path of the panoramic sun roof »» page 144 and the rear lid.
- On opening the rear lid make sure that it does not knock into the roof load.

 For the sake of the environment

When cross bars and a roof carrier system are installed, the increased air resistance means that the vehicle uses more fuel.

Attach the cross bars and the roof carrier system

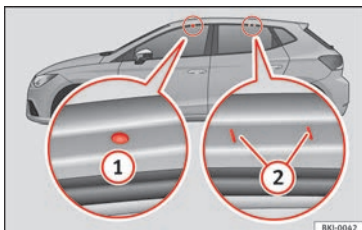

Fig. 172 Attachment points for the roof railings for the roof carrier system.

The crossbars are the basis of a series of special roof carrier systems. For safety reasons, special fixtures must be used to safely transport luggage, bicycles, skis, surf boards or boats on the roof. Suitable accessories can be acquired at SEAT dealerships.

Always secure the crossbars and the roof carrier system properly. Always take the assembly instructions that come with the crossbars and the roof carrier system in question into account.

The front and rear attachment points ① and ② are only visible when the doors are open »» Fig. 172.

 **WARNING**

Incorrect attachment and use of the crossbars and the roof carrier system may cause the whole system to detach from the roof and cause an accident and injuries.

- Always take the manufacturer assembly instructions into account.
- Use only crossbars and the roof carrier system when they are in perfect condition and are properly secured.
- Secure the crossbars and the roof carrier system properly.
- Check threaded joints and attachments travelling and if necessary tighten them after you have travelled a short distance. When making long trips, check the threaded joints whenever you stop for a rest.
- Always fit the special roof carrier systems correctly for wheels, skis and surfboards, etc.
- Do not modify or repair the crossbars or roof carrier system.

 **Note**

Always read the assembly instructions that come with the crossbars and the roof carrier system carefully and keep them in the vehicle.

Loading the roof carrier system

The load can only be secured if the crossbars and the roof carrier system are properly installed »» .

Maximum authorised roof load

The maximum permissible roof load is **75 kg**. This figure comes from the combined weight of the roof carrier, the cross bars and the load itself on the roof »» .

Always check the weight of the roof carrier system, the cross bars and the weight of the load to be transported and weigh them if necessary. Never exceed the maximum authorised roof load.

If you are using cross bars and a roof carrier with a lower weight rating, you will not be able to carry the maximum authorised roof load. In this case, do not exceed the maximum weight limit for the roof carrier which is listed in the fitting instructions.

Distributing a load

Distribute loads uniformly and secure them correctly »» .

»

Check attachments

Once the cross bars and roof carrier system have been installed, check the bolted connections and attachments after a short journey and subsequently with a certain frequency.

WARNING

Exceeding the maximum authorised roof load can result in accidents and considerable vehicle damage.

- Never exceed the maximum authorised load on the roof and on the axles or the vehicle's maximum authorised weight.
- Never exceed the load capacity of the cross bars and the roof carrier system, even if the maximum authorised roof load has not been reached.
- Secure heavy items as far forward as possible and distribute the vehicle load uniformly.

WARNING

If the load is loose or not secured, it could fall from the roof carrier system or cause accidents and injuries.

- Always use belts or retaining straps that are suitable and in a good condition.
- Secure the load properly.

Air conditioning

Heating, ventilation and cooling

General notes

Read the additional information carefully

»  page 51

Pollution filter

The pollution filter (a combined particulate filter and active carbon filter) serves as a barrier against impurities in the outside air, including dust and pollen.

For the climate control system to work with maximum efficiency, the pollution filter must be replaced at the specified intervals in the Maintenance Programme.

If the filter loses efficiency prematurely due to use in areas reaching very high pollution levels, the pollen filter must be changed more frequently than stated in the Service Schedule.

WARNING

Reduced visibility through the windows increases the risk of serious accidents.

- Always ensure that all windows are free of ice and snow, and that they are not fogged,

so as to maintain good visibility of everything outside.

- The maximum heat output required to defrost windows as quickly as possible is only available when the engine has reached its normal running temperature. Only drive when you have good visibility.
- Always ensure that you use the heating system, fresh air system, air conditioner and the heated rear window to maintain good visibility to the outside.
- Never leave the air recirculation on for a long period of time. If the cooling system is switched off and air recirculation mode switched on, the windows can mist over very quickly, considerably limiting visibility.
- Switch air recirculation mode off when it is not required.

WARNING

Stuffy or used air will increase fatigue and reduce driver concentration possibly resulting in a serious accident.

- Never leave the fresh air fan turned off or use the air recirculation for long periods of time; the air in the vehicle interior will not be refreshed.

CAUTION

- If you suspect that the air conditioner is damaged, switch it off with the  button to

prevent further damage and have it checked by a specialised workshop.

- Repairs to the air conditioner require specialist knowledge and special tools. Therefore, we recommend you to take the vehicle to a specialised workshop.

Note

- If the humidity and temperature outside the vehicle are high, condensation can drip off the evaporator in the cooling system and form a pool underneath the vehicle. This is normal and does not indicate a leak.
- Keep the air intake slots in front of the windscreen free of snow, ice and leaves to ensure heating and cooling are not impaired, and to prevent the windows from misting over.
- The air from the vents flows through the vehicle interior and is extracted by slots in the luggage compartment designed for this purpose.

pose. Therefore, you should avoid obstructing these slots with any kind of object.

- The air conditioner operates most effectively with the windows and the sliding/tilting sunroof* closed. However, if the temperature inside the vehicle is excessive because of the sun, the air inside can be cooled faster by opening the windows for a short time.
- Do not smoke while air recirculation mode is on, as smoke drawn into the air conditioning system leaves residue on the evaporator, producing a permanent unpleasant odour.
- At low outside temperatures, the compressor switches off automatically and cannot be switched on even with the **AUTO** button.
- It is advisable to turn on the air conditioning at least once a month, to lubricate the system gaskets and prevent leaks. If a decrease in the cooling capacity is detected, a Technical Service should be consulted to check the system.

- To ensure correct operation, the grilles on both sides of the screen must not be obstructed.

- When the engine is under extreme strain, switch off the compressor for a moment.

Economic use of the air conditioning

When the air conditioning is switched on, the compressor consumes engine power and has influence on fuel consumption. Consider the following points in order to have the system operating in the minimum possible time.

- If the vehicle interior has overheated due to an excessive solar radiation, it is best to open the windows or doors to allow the hot air to escape.
- While in motion, the air conditioning should not be switched on if the windows or the sunroof* are open.

Air outlets

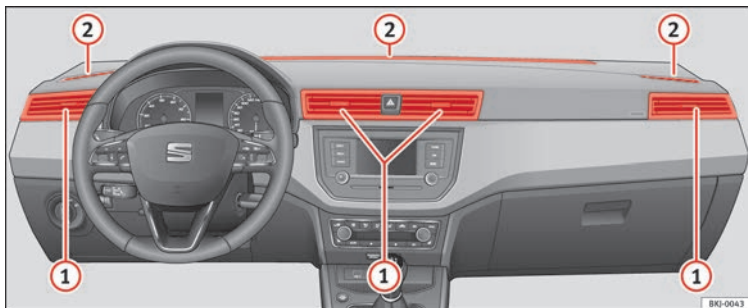

Fig. 173 Air vents.

To ensure proper heating, cooling and ventilation in the vehicle interior, air vents **» Fig. 173 ①** should remain open.

- The outlets can be closed or opened separately using the slats and the air flow directed according to need.

There are other additional, non-adjustable air vents in the dash panel **②**, in the footwell and in the rear area of the interior.

Note

Food, medicine and other heat or cold sensitive objects should never be placed in front of the air outlets as they may be damaged or made unsuitable for use by the air coming from the air vents.

Air recirculation

Air recirculation prevents unpleasant smells, e.g. when passing through a tunnel or in queuing traffic, from entering the interior.

If the air distribution is in the thaw position, the recirculation flap will always be open (indicator light off).

If the air distribution is switched from any position to the thaw position, recirculation will be automatically deactivated.

Connecting the recirculation

In any air distribution position except thaw:

- Press the  button, the button's lamp will light up, indicating that air recirculation inside the vehicle has been activated.

Disconnecting the recirculation

In any air distribution position except thaw:

- Press the  button again and the button's lamp will go off, indicating that air entry from the outside has been activated.

In the thaw position  the entry of air into the vehicle interior is always from the outside.

⚠ WARNING

In air recirculation mode, no cold air from the outside enters the vehicle interior. If the air conditioner is switched off, the windows can quickly mist over. Therefore, never leave the

air recirculation mode switched on for a long time (risk of accident).

i Note

• Activating air recirculation automatically activates the A/C button (to prevent the windows from misting up). If the temperature regulator is turned to the coldest setting (blue point), the air recirculation function and the A/C button are automatically activated.

• If the function is not deactivated by pressing the button, it will deactivate after approximately 20 minutes.

Heating and fresh air

Controls

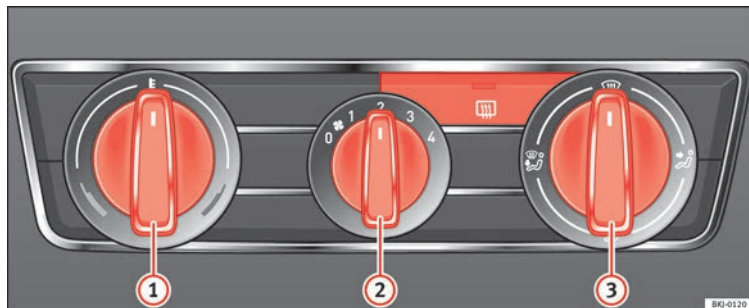

① Temperature regulator»» page 170.

② Blower control. There are four speed settings for the blower. The blower should

Fig. 174 Heating controls on the dash panel.

always be set at the lowest speed when driving slowly. »

- ③ Air distribution regulator.
- 🌀 Heated rear window.

Air distribution

Control ③ for setting the flow of air in the required direction.

- 🌀 – Air distribution towards the windscreen in order to demist.
- 👤 – Air distribution to upper body.
- 👤 – Air distribution to footwell
- 🌀 – Air distribution to the windscreen and the footwell.

⚠️ WARNING

• For your safety, the windows should never be fogged up or covered with snow or ice. This is essential to ensure good visibility. Please familiarise yourself with the correct operation of the heating and ventilation system, including the demist/defrost functions for the windows.

📘 Note

- Please consider the general notes
»» page 166.

Functions

Ventilating the vehicle interior

The desired temperature inside the vehicle cannot be lower than the ambient temperature.

- Turn the temperature selector
»» Fig. 174 ① anti-clockwise.
- Turn blower switch ② to any of the levels 1-4.
- Set the airflow to the desired direction using air distribution control ③.
- Open the relevant air outlets.

Interior heating

Maximum heat output, which is needed to defrost the windows quickly, is only available when the engine has reached its operating temperature.

- Turn the temperature selector
»» Fig. 174 ① clockwise to select the required temperature.
- Turn blower switch ② to any of the levels 1-4.
- Set the airflow to the desired direction using air distribution control ③.
- Open the relevant air outlets.

Defrosting the windscreen

- Turn the temperature regulator
»» Fig. 174 ① clockwise to reach the maximum temperature.
- Turn the blower switch ② to level 4.
- Turn air distribution control to 🌀.
- Close the central outlets.
- Open and turn the side outlets towards the windows.

Keeping the windscreen and the side windows demisted

- Turn the temperature regulator
»» Fig. 174 ① to the heating zone.
- Turn blower switch ② to any of the levels 2-3.
- Turn air distribution control to 🌀.
- Close the central outlets.
- Open and turn the side outlets towards the windows.

Once the windows are demisted and as a preventive measure, the control ③ can be set in position 🌀 greater comfort while preventing the windows from misting again.

📘 Note

Remember that the temperature of the engine coolant should be optimum to ensure that the heating system functions correctly (except in vehicles fitted with additional heating*).

Manual air conditioning*

Controls



Fig. 175 Air conditioning controls on the dash panel.

- ① Temperature selector » page 171
- ② Blower control. There are four speed settings for the blower. At low speed, it is recommended to set the blower to a minimum of 1 to improve the intake of fresh air.
- ③ Air distribution regulator.
- ☞ Air recirculation button » page 168. When the function is activated, a warning light on the button is turned on.
- ☞ Heated rear window.
- A/C Button to switch on air conditioning » page 171. The air conditioning system

only works when the engine is running and the fan is switched on.

⚠ WARNING

For your safety, the windows should never be fogged up or covered with snow or ice. This is essential to ensure good visibility. Please familiarise yourself with the correct operation of the heating and ventilation system, including the demist/defrost functions for the windows.

📄 Note





Please consider the general notes.

Functions

Interior heating

Maximum heat output, which is needed to defrost the windows quickly, is only available when the engine has reached its operating temperature.





- Turn off the cooling system using the **A/C** button » Fig. 175 (the button light turns off).
- Turn the temperature regulator » Fig. 175 ① to set the desired temperature inside the vehicle.
- Turn the blower switch to any of the settings 1-4.

- Set the air distribution regulator » **Fig. 175** ③ to the air flow configuration desired:  (towards the windscreen),  (towards the chest),  (towards the footwell) and  (towards the windscreen and footwell).

Interior cooling

When the air conditioning is switched on, the temperature and the air humidity go down. This way, if the outside humidity is extreme, the air conditioning prevents the misting of the windows and therefore, comfort is improved.

- Turn on the cooling system using the **A/C** button (the button light turns on).
- Turn the temperature control switch until the desired interior temperature is reached.

- Turn the blower switch to any of the settings 1-4.
- Set the air distribution control to the air flow configuration desired:  (towards the windscreen),  (towards the chest),  (towards the footwell) and  (towards the windscreen and footwell).

Demisting the windscreen

- Turn air distribution to .
- Turn the fan control to one of the two levels depending on the speed required.
- Rotate the temperature control to the desired level of comfort.
- Close the central outlets.
- Open and turn the side outlets towards the windows.

If the air conditioning does not work, this may be due to the following reasons:

- The engine is stationary.
- The fan blower is switched off.
- The outside temperature is lower than +3°C (+37°F).
- The air conditioning system compressor has been temporarily switched off because of an increased engine coolant temperature.
- The air conditioner fuse is faulty.
- Another fault in the vehicle. Have the air conditioning checked by a specialised workshop.

Climatronic*

General notes

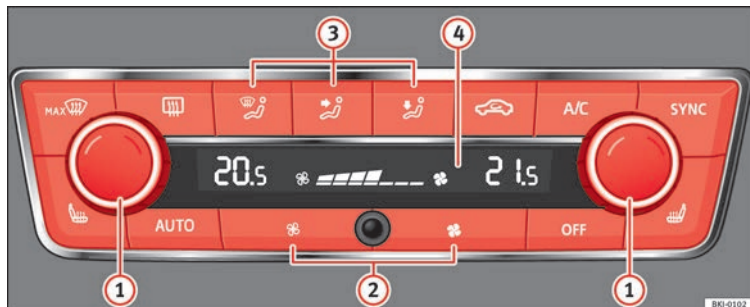

Fig. 176 Climatronic: controls.

Read the additional information carefully

» page 52

Climatronic automatically maintains a comfortable temperature. To do so, it automatically regulates the supplied air temperature and the blower and air distribution levels. The system also allows for the effect of sunlight, so there is no need for manual adjustment.

Automatic operation guarantees maximum comfort any time of year » page 174.

Climatronic description

Cooling only works if the following conditions are met:

- The engine is running
- the outside temperature is above +2°C (+36°F);
- **A/C** turned on.

Starting the Climatronic

When a button is pressed, the corresponding function will be activated (except for the recirculation button), switching on the air conditioning if it was switched off.

Switching off the Climatronic

- Adjust fan power to zero » Fig. 176 ② or press the **OFF** button.

In order to ensure engines subject to heavy loads are cooled, the air conditioning compressor is switched off in the event of high coolant temperatures.

Recommended setting for all seasons of the year

- Set the required temperature. We recommend +22°C (+72°F).
- Press the button **AUTO** » Fig. 176.

»

- Adjust the vents so that the air flow is directed slightly upwards.

Change between degrees Centigrade and degrees Fahrenheit

The units of degrees can be changed via the Easy Connect system using the  button and the function button **SETTINGS > Units > Temperature**.

Automatic mode

Automatic mode is used to maintain a constant temperature and demist the windows inside the vehicle.

- Set a interior temperature between +16°C (+64°F) and +29°C (+84°F).
- Adjust the vents so that the air flow is directed slightly upwards.
- Press the **AUTO** button, **AUTO** is displayed on the screen.

Automatic mode is switched off by pressing the air distribution buttons or increasing or decreasing the blower speed. However, the temperature remains regulated.

Adjusting the temperature

- When you switch on the ignition, control  **>>> Fig. 176** can be used to set the required interior temperature.

It is possible to select interior temperatures from +16°C (+64°F) to +29°C (+84°F). In this range the temperature is regulated automatically. If a temperature below +16°C (+64°F) is selected, “LO” is displayed on the screen. If a temperature above +29°C (+84°F) is selected, “HI” is displayed on the screen. At both extremes, Climatronic works at maximum cooling or heating power, respectively. The temperature is not regulated.

In the event of prolonged, irregular distribution of the air flow from the outlets (particularly the footwells) and significant differences in temperature, e.g. on leaving the vehicle, sensitive people may catch cold.

Fan regulation

Climatronic automatically regulates blower speed according to the interior temperature. It is possible, however, to set the blower speed to suit requirements.

- Press the  buttons to increase or reduce fan speed.

Climatronic will switch off when the blower switches off.

Turn on windscreen defrost

- Press the button  **>>> Fig. 176**.

Switching off windscreen defrosting

- Press the  button several times or press the **AUTO** button.

The temperature is regulated automatically. The air output from the vents **>>> Fig. 173 ** is increased.

WARNING

Read and observe the safety warnings **>>> ** in General notes on page 166.

Note

- **A visit to the specialised service once a year is recommended to clean the Climatronic system.**
- **The interior temperature sensor is at the bottom. Do not cover it with stickers or the like, as this could have a negative effect on Climatronic operations.**

Driving

Starting and stopping the engine

Ignition key positions

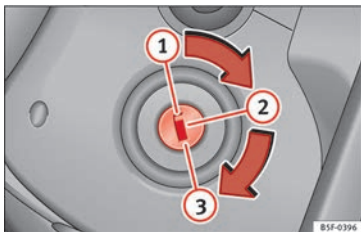

Fig. 177 Ignition key positions.

Read the additional information carefully
» page 31

Ignition switched off, steering lock

In this position » **Fig. 177 ①** the ignition and the engine are off and the steering may be locked.

For the **Steering lock** to operate without the ignition key, turn the steering wheel until it locks with an audible sound. You should always lock the steering wheel when you leave your vehicle. This will help prevent vehicle theft » .

Switching the ignition or the glow plug system on

Turn the ignition key to this position and release it **②**. If the key cannot be turned or it is difficult to turn from position **①** to position **②**, move the steering wheel from one side to the other; this will release it.

Starting

The engine is started when the key is in this position **③**. Electrical devices with high power consumption are switched off temporarily at the same time.

Each time that the vehicle is restarted, the ignition key must be turned to position **①**. The **repetitive start prevention lock** of the ignition prevents possible damage to the starter motor if the engine is already running.

WARNING

• The ignition key must **NOT** be removed from the lock until the vehicle comes to a standstill. Otherwise, the steering could be immediately blocked- Risk of accident!

• Always remove the key from the ignition when leaving the vehicle, even if only for a short period. This is especially important if children or disabled people are left alone in the vehicle. They could accidentally start the engine or work electrical equipment such as the electric windows, resulting in an accident.

• Unsupervised use of the key could start the engine or any electrical system, such as the electric windows. This could result in serious injury.

CAUTION

The starter motor will only work when the engine is stopped (ignition key position **③**).

Starting petrol engines

The engine can only be started using a genuine SEAT key with its correct code.

- Move the gearbox lever to the neutral position and depress the clutch pedal thoroughly and hold it in this position for the starter to turn the engine on.
- Turn the ignition key to the starting position » **Fig. 177 ③**.
- Let go of the ignition key as soon as the engine starts; the starter motor must not run on with the engine.

After starting a very hot engine, you may need to slightly press down the accelerator.

When starting a cold engine, it may be a little noisy for the first few seconds until oil pressure has built up in the hydraulic valve compensators. This is quite normal, and no cause for concern. »

If the engine does not start immediately, switch the starter off after 10 seconds and try again after half a minute. If the engine still does not start, the fuel pump fuse should be checked » page 104, Fuses.

WARNING

- Never start or run the engine in unventilated or closed rooms. The exhaust gases contain carbon monoxide, an odourless and colourless poisonous gas. Risk of fatal accidents. Carbon monoxide can cause loss of consciousness and result in death.
- Never leave the vehicle unattended if the engine is running.
- Never use “cold start sprays”, they could explode or cause the engine to run at high revs. Risk of injury.

CAUTION



- When the engine is cold, you should avoid high engine speeds, driving at full throttle and over-loading the engine. Risk of engine damage.
- The vehicle should not be pushed or towed more than 50 metres to start the engine. Unburnt fuel could enter the catalytic converter and damage it.
- Before attempting to push-start or tow a vehicle in order to start it, you should first try to start it using the battery of another vehicle. Please observe and follow the notes on the »  page 71, How to jump start.

For the sake of the environment

Do not warm-up the engine by running the engine with the vehicle stationary. Start off immediately, driving gently. This helps the engine reach operating temperature faster and reduces emissions.

Starting diesel engines

The engine can only be started using a genuine SEAT key with its correct code.

- Move the gearbox lever to the neutral position and depress the clutch pedal thoroughly and hold it in this position for the starter to turn the engine on.
- Turn the ignition key to position » **Fig. 177** . The warning lamp  will light for engine pre-heating.
- When the lamp turns off, turn the ignition key to position  to start the engine. Do not press the accelerator.
- Release the ignition key as soon as the engine starts. The starter motor should not turn at the same time.

When starting a cold engine, it may be a little noisy for the first few seconds until oil pressure has built up in the hydraulic valve compensators. This is quite normal, and no cause for concern.

If there are problems starting the engine, see the »  page 71.

Glow plug system for diesel engines

To avoid unnecessary discharging of the battery, do not use any other major electrical equipment while the glow plugs are pre-heating.

Start the engine as soon as the glow plug warning lamp goes out.

Starting a diesel engine after the fuel tank has run dry

If the fuel tank has been completely run dry, it may take longer than normal (up to one minute) to start a diesel engine after refuelling. This is because the fuel system must eliminate air first.

WARNING

Observe the safety warnings »  in Starting petrol engines on page 176.

CAUTION

- When the engine is cold, you should avoid high engine speeds, driving at full throttle and over-loading the engine. Risk of engine damage.
- The vehicle should not be pushed or towed more than 50 metres to start the engine. Unburnt fuel could enter the particulate filter and damage it.

- Before attempting to push-start or tow a vehicle in order to start it, you should first try to start it using the battery of another vehicle. Please observe and follow the notes on the  page 71, How to jump start.

For the sake of the environment

Do not warm-up the engine by running the engine with the vehicle stationary. You should drive off as soon as you start the engine. This helps the engine reach operating temperature faster and reduces emissions.

“SAFE” electronic immobiliser¹⁾

The electronic immobiliser prevents unauthorised persons from driving the vehicle.

Inside the key there is a chip that deactivates the electronic immobiliser automatically when the key is inserted into the ignition.

The electronic immobiliser will be activated again automatically as soon as you pull the key out of the ignition lock.

The engine can only be started using a genuine SEAT key with its correct code.



If the following message* is shown on the instrument panel display: **SAFE**, the vehicle cannot be started.

The engine can, however, be started if the appropriate coded SEAT genuine key is used.

Note

A perfect operation of the vehicle is ensured if genuine SEAT keys are used.

Switching off the engine

- Stop the vehicle.
- Turn the ignition key to position  **Fig. 177** .

After switching the engine off, the radiator fan may run on for up to 10 minutes. It is also possible that the fan turns itself on once more if the coolant temperature increases due to the heat accumulated in the engine compartment or due to its prolonged exposure to solar radiation.

WARNING

- Never switch the engine off until the vehicle is completely stationary.
- The brake servo works only when the engine is running. With the engine switched off, more strength is needed to brake. As normal brake operation cannot be performed, risk of accidents and serious injury may exist.

- The steering lock can be immediately blocked once the key is removed from the ignition. The vehicle cannot be steered. Risk of accident.
- Power-assisted steering does not work when the engine is off, and more strength is needed to turn the wheel.
- If the key is removed from the ignition lock the steering lock could be engaged and vehicle steering would not work.

CAUTION

- When the engine has been running under a heavy load for a long period, heat can accumulate in the engine compartment and cause engine damage. For this reason, idle the engine for approximately 2 minutes before switching it off.
- If the vehicle is stopped and the Start-Stop system* switches off the engine, the ignition remains switched on. Make sure that the ignition is switched off before leaving the vehicle, otherwise the battery could discharge.

¹⁾ Available depending on the market

Starter button*

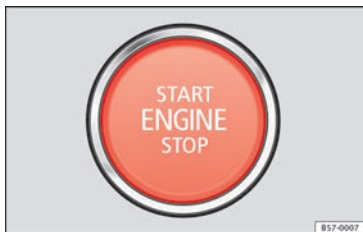

Fig. 178 In the lower part of the centre console: starter button.



Fig. 179 On the right of the steering column: emergency start.

The vehicle engine can be started with a starter button (Press & Drive). To do so, there must be a valid key inside the vehicle in the area of the front or rear seats.

Opening the driver's door **when exiting the vehicle** activates the electronic lock on the steering column if the ignition is disabled.

Switching the ignition on/off manually

Briefly push the starter button without touching the brake or clutch pedal » .

For vehicles with both manual and automatic transmission, the starter button text **START ENGINE STOP** flashes like a heartbeat when the system is preset for switching the ignition on and off.

Automatic ignition switch-off

If the driver leaves the vehicle, taking the vehicle key with them but leaving the ignition on, the ignition is not switched off automatically. The ignition is switched off automatically by pressing the lock button on the remote control or manually by pressing the sensor surface on the door lever » **Fig. 144**

Emergency starting function

If no valid key is detected inside the vehicle, an emergency start-up will be required. The relevant message will appear in the dash panel display. This may happen when, for example, the battery of the vehicle key button is very low or flat:

- Immediately after pushing the starter button, keep the vehicle key next to the right

trim of the steering column » **Fig. 179**, as close as possible to the Kessy logo.

- The ignition connects and the engine starts automatically.

Emergency disconnection

If the engine does not switch off after briefly pressing the starter button, an emergency disconnect will be required:

- Press the starter button twice within 3 seconds or press it once for more than 1 second » .
- The engine turns off automatically.

Engine restart feature

If no valid key is detected inside the vehicle after the engine stops, you will only have 5 seconds to restart it. A warning will display on the dash panel screen.

After this interval, it will not be possible to start the engine without a valid key inside the vehicle.

Automatic deactivation of the ignition on vehicles with the Start-Stop system

The ignition is switched off automatically when the vehicle is stopped and the automatic engine shutdown is active, if:

- The driver's seat belt is not fastened,
- the driver does not step on any pedal,

- the driver door is opened.

After automatically turning off the ignition, if the dipped beam  is on, the side light remains on for approx. 30 minutes (if the battery is sufficiently charged). If the driver locks the vehicle or manually turns off the light, the side light goes out.

WARNING

Any accidental movement of the vehicle could result in serious injury.

- When switching on the ignition, *do not* press the brake or clutch pedal, otherwise the engine could start immediately.

WARNING

If vehicle keys are used negligently or without due care, this may cause accidents and serious injury.

- Never leave any key inside the vehicle when exiting. Otherwise, a child or unauthorised person could lock the vehicle, start the engine or connect the ignition and, in this way, operate electronic equipment (e.g. the windows).

Note

- Before leaving the vehicle, always disconnect the ignition manually and, if appropriate, take into account the instructions on the screen of the dash panel.

• If the vehicle is stationary for a long time with the ignition on, the vehicle battery might be discharged and it might not be possible to start the engine.

• In diesel vehicles, there may be a delay in the engine starting if it requires preheating.

• If during the STOP phase you press the **START ENGINE STOP** button, the ignition is switched off and the button flashes.

• If the indication “Start-Stop system deactivated: Start the engine manually” is displayed on the dash panel display, the **START ENGINE STOP** button will blink.

Starting the engine

✓ Valid for vehicles: with starter button

Step	Starting the engine with the starter button » page 178.
1.	Press and hold the brake pedal until step 5 is performed.
1a.	In vehicles with a manual gearbox: press and hold the clutch down until the engine starts.
2.	Put the gearbox lever in neutral or the selector lever in position P or N.

Step	Starting the engine with the starter button » page 178.
3.	Briefly press the starter button » Fig. 178 without pressing the accelerator. For the engine to start there must be a valid key in the vehicle. After starting the engine, the light of the START ENGINE STOP button changes to a fixed light indicating that the engine has started.
4.	If the engine does not start, stop and wait for approx. 1 minute before trying again. If necessary, perform an emergency start » page 178.
5.	Disconnect the hand brake when you are about to start driving » page 182.

WARNING

Never leave the vehicle with the engine running, especially if a gear or gear range is engaged. The vehicle could then suddenly move or something strange could happen that would cause damage, fire or serious injury.

WARNING

Cold start sprays could explode or cause a sudden increase in the engine speed.

- Never use sprays to cold start the engine.

CAUTION

- The starter motor or the engine may be damaged if you try to start the engine while »

driving or if you restart it immediately after switching it off.

- If the engine is cold, avoid high engine speeds, pushing the engine too hard and rapid acceleration.
- Do not start the engine by pushing the vehicle or towing it. Unburnt fuel could enter the catalytic converter and damage it.

Note

- Do not wait until the engine warms up with the vehicle stationary; if you have good visibility through the windows, start driving immediately. This helps the engine reach operating temperature faster and reduces emissions.
- Electrical components with a high power consumption are switched off temporarily when the engine starts.
- When starting with a cold engine, noise levels may briefly increase. This is quite normal, and no cause for concern.
- When the outside temperature is below +5°C (+41°F), if the engine is diesel, some smoke may appear under the vehicle when the fuel-operated auxiliary heater is on.

Stopping the engine

✓ Valid for vehicles: with starter button

Step	Switch off the engine with the starter button »» page 178.
1.	Stop the vehicle completely »»  .
2.	Press and hold the brake pedal until the step 4 is performed.
3.	If you are driving an automatic vehicle, place the selector lever in position P.
4.	Apply the handbrake »» page 182.
5.	Briefly press the start-up button »» Fig. 178. The (START ENGINE STOP) button blinks again. If the engine fails to switch off, perform an emergency disconnect »» page 178.
6.	If the vehicle is equipped with a manual gearbox, put it into 1st or reverse.

WARNING

Never switch off the engine while the vehicle is moving. This could cause loss of control of the vehicle, accidents and serious injury.

- The airbags and belt tensioners do not work when the ignition is switched off.
- The brake servo does not work with the engine off. Therefore, you need to press the brake pedal harder to brake the vehicle.
- Power steering does not work when the engine is not running. You need more strength to steer when the engine is switched off.

- If the ignition is switched off, the steering column could be locked, making it impossible to control the vehicle.

CAUTION

If the engine is made to work hard for a long time, it may overheat after being switched off. To prevent damage to the engine before switching it off, leave it idle for approx. 2 minutes in neutral.

Note

After switching off the engine, the cooling fan may continue to operate in the engine compartment for a few more minutes, even with the ignition off. The radiator fan is automatically switched off.

“My Beat” Function

For vehicles with a convenience key there is the “My Beat” function. This feature provides an additional indication of the vehicle ignition system.

When accessing the vehicle, e.g. by opening the doors with the remote control, the **(START ENGINE STOP)** button flashes, calling attention to the relevant starter system button.

Upon switching the ignition on/off, the light of the **(START ENGINE STOP)** button flashes. With the engine switched off, after a few seconds,

the **STOP ENGINE START** button stops flashing and goes out.

With the engine running, the **START ENGINE STOP** button light stays on, indicating that the engine is running. The time that lapses between the moment the user starts the engine with the **START ENGINE STOP** button and the lighting changes from flashing to fixed will depend on specific engine size characteristics. Upon switching the ignition off with the **START ENGINE STOP** button, it starts flashing again.

In vehicles **with the Start-Stop system**, the “My Beat” function also offers additional information:

- When the engine stops during the Stop phase, the light of the **START ENGINE STOP** button stays on, since, even though the engine is off, the Start-Stop system is active.
- When the engine cannot be started again with the Start-Stop system, » page 204, and needs to be started manually, the **START ENGINE STOP** button flashes to indicate this fact.

Braking and parking

Braking capacity and braking distance

The efficiency of the brakes depends directly on the **brake pad** wear. This wear depends to

a great extent on the conditions under which the vehicle is operated and the way the vehicle is driven. If you often drive in town, drive short distances or have a sporty driving style, we recommend that you have the thickness of your brake pads checked by technical services more frequently than recommended in the Maintenance Programme.

If you drive with **wet brakes**, for example, after crossing areas of water, on days of heavy rainfall or even after washing the car, the effect of the brakes is reduced as the brake discs are wet or even frozen (in winter): in this case, the brakes should be “dried” by pressing the brake pedal several times.

WARNING

Longer braking distances and faults in the brake system increase the risk of accidents.

- **New brake pads must be run in and do not have the correct friction during the first 200 km (124 miles). This reduced braking capacity may be compensated for by pressing on the brake pedal a little harder, which also applies when the brake pads have to be changed further on.**
- **If brakes are wet or frozen, or if you are driving on roads which have been salted, braking power may be lower than normal.**
- **On steep slopes, if brakes are excessively used, they will overheat. Before driving down a long steep slope, it is advisable to reduce speed and change down into a lower gear or**

range (depending on the type of transmission). Thus, make use of engine braking and relieve the brakes.

- **Never let the brakes “drag” by applying light pressure. Continuous braking will cause the brakes to overheat and the braking distance will increase. Apply and then release the brakes alternately.**
- **Never let the vehicle run with the engine switched off. The braking distance is increased considerably when the brake servo is not active.**
- **If the brake fluid loses its viscosity and is subjected to heavy use, vapour bubbles can form in the brake system. This reduces the efficiency of the brakes.**
- **Non-standard or damaged front spoilers could restrict the airflow to the brakes and cause them to overheat. Before purchasing accessories please observe the relevant instructions » page 247, Technical modifications.**
- **If a brake system circuit fails, the braking distance will be increased considerably. Contact a specialised workshop immediately and avoid unnecessary journeys.**

Control lamp



Situations in which the warning lamp lights up *

- the brake fluid level is too low
» page 271.

- there is a fault in the brake system.

This warning lamp can light up together with the ABS system warning lamp.

WARNING

- If the brake warning lamp does not go out or if it lights up when driving, the brake fluid level in the reservoir is too low so there is a risk of an accident »» page 271, Brake fluid. Stop the vehicle and do not drive on. Obtain technical assistance.
- If the brake warning lamp lights up  together with the ABS lamp  this could be due to an ABS fault. This could cause the rear wheels to lock quickly when you brake. This could cause the rear to break away. Risk of skidding. Stop the vehicle and seek technical assistance.

Handbrake

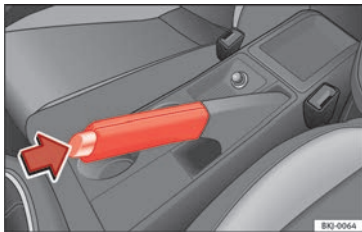



Fig. 180 Handbrake between the front seats.

The handbrake should be applied firmly to prevent the vehicle from accidentally rolling away. Always apply the handbrake when you leave your vehicle and when you park.

Applying the handbrake

- Pull the handbrake lever up firmly »» Fig. 180.

Releasing the handbrake

- Pull the lever up slightly and press the release knob in the direction of the arrow »» Fig. 180 and guide the handbrake lever down fully »» .

Always pull the handbrake *all the way up*, so there is less risk of driving off with it still engaged »» .

The handbrake warning lamp  lights up when the handbrake is applied and the ignition switched on. The warning lamp turns off when the handbrake is released.

WARNING

- Never use the handbrake to stop the vehicle when it is in motion. The braking distance is considerably longer, because braking is only applied to the rear wheels. Risk of accident!
- If the handbrake is only partially released, this will cause the rear brakes to overheat, which can impair the function of the brake system and could lead to an accident. This al-

so causes premature wear on the rear brake pads.

CAUTION

Always apply the handbrake before you leave the vehicle. Put it in 1st gear as well. In vehicles with an automatic gearbox, place the gear lever in position P.

Parking

The handbrake should always be firmly applied when the vehicle is parked.

Always note the following points when parking the vehicle:

- Use the brake pedal to stop the vehicle.
- Apply the handbrake.
- Put it in 1st gear.
- Switch the engine off and remove the key from the ignition. Turn the steering wheel slightly to engage the steering lock.
- Always take your keys with you when you leave the vehicle »» .

Additional notes on parking the vehicle on gradients:

Turn the steering wheel so that the vehicle rolls against the kerb if it started to roll.

- If the vehicle is parked facing **downhill**, turn the front wheels so that they point *towards the kerb*.
- If the vehicle is parked facing **uphill**, turn the front wheels so that they point *away from the kerb*.
- Secure the vehicle as usual by applying the handbrake firmly and putting it in 1st gear.

WARNING

- **Take measures to reduce the risk of injury when you leave your vehicle unattended.**
- **Never park where the hot exhaust system could ignite inflammable materials, such as dry grass, low bushes, spilt fuel etc.**
- **Never allow vehicle occupants to remain in the vehicle when it is locked. They would be unable to open the vehicle from the inside, and could become trapped in the vehicle in an emergency. In the event of an emergency, locked doors will delay assistance to vehicle occupants.**
- **Never leave children alone in the vehicle. They could set the vehicle in motion, for example, by releasing the handbrake or the gearbox lever.**
- **Depending on weather conditions, it may become extremely hot or cold inside the vehicle. This can be fatal.**

Braking and stability systems

Electronic Stability Control (ESC)*

This Electronic Stability System reduces the risk of skidding and improves the vehicle's stability and ability to hold the road.

The Electronic Stability Control (ESC) contains the electronic differential lock (EDL) and the traction control system (ASR). The ESC works together with the ABS. Both control lamps will light up if the ESC or ABS systems are faulty.

The ESC system is started automatically when the engine is started.

The ESC system is always active and cannot be switched off. With the Easy Connect system it is only possible to deactivate the ASR or else select Sport mode.

The ASR can be deactivated when wheel spin is desirable »» page 184.

For example:

- When driving with snow chains.
- When driving in deep snow or on loose surfaces.
- When the vehicle is stuck, to rock it backwards and forwards.

Press the button to switch the ASR back on when you no longer need wheel spin.



Electronic Stability Control (ESC)*

The ESC reduces the risk of skidding by braking the wheels individually.

The system uses the steering wheel angle and road speed to calculate the changes of direction desired by the driver, and constantly compares them with the actual behaviour of the vehicle. When irregularities occur, for example, if the vehicle begins to skid, the ESC brakes the appropriate wheel automatically.

The forces acting on the braked wheel bring the vehicle back to a stable condition. If the vehicle tends to oversteer (the rear end slides out), the system will act on the front wheel on the outside of the turn.

Control lamp

There are two control lamps for the electronic stability control. The lamp  provides information concerning function and  disconnection status.

Both control lamps light up together when the ignition is switched on and should turn off after approximately 2 seconds. This is the time taken for the function check.

This programme includes the ABS, EDL and ASR. It also includes emergency braking assistance (BAS).



The control lamp  has the following functions:

- It flashes whilst driving when the ASR/ESC is activated.
- It will light up if there is a fault in the ESC.
- As the ESC operates in conjunction with the ABS, the ESC light will also come on if a fault should occur in the ABS.

If the ESC control lamp  lights up and stays on after the engine is started, this may mean that the control system has temporarily switched off the ESC. In this case the ESC can be reactivated by switching the ignition off and then on again. If the control lamp goes out, this means the system is fully functional.

The  lamp provides information about the disconnection status of the system:

- It stays lit when the ASR is disconnected or if you select ESC Sport mode, only by means of Easy Connect.

WARNING

- **Do not forget that the electronic stability control ESC cannot defy the laws of physics. Bear this in mind, particularly on slippery and wet roads and when towing a trailer.**
- **Always adapt your driving style to suit the condition of the roads and the traffic situation. The greater safety provided by the ESC should not encourage you to run any risks.**

CAUTION

- **To ensure that the ESC works correctly, all four wheels must be fitted with the same tyres. Any differences in the rolling radius of the tyres can cause the system to reduce engine power when this is not desired.**
- **Any modifications made to the vehicle (for example, to the engine, brake system, running gear or to the combination of wheels and tyres) may affect the operation of the ABS, EDL, ESC and ASR.**

Traction control system (ASR)



The traction control system prevents the driven wheels from spinning when the vehicle is accelerating.

Description and operation of the traction control system during acceleration (ASR)

The ASR system intervenes by reducing engine power and preventing the driven wheels from slipping during acceleration.

TCS helps the car to start moving, accelerate and climb a gradient in slippery conditions where this may otherwise be difficult or even impossible.



The ASR automatically switches on when the engine is started. If necessary, it could be switched on or off using the Easy Connect system*.

When the ASR is off, the warning lamp lights up . The ASR should normally be left on. Only in exceptional cases can it be disconnected, i.e. when you want the wheels to slide; this done through the Easy Connect system, by means of the  button and the function button **SETTINGS> ESC system**, for example:

- With compact temporary spare wheel.
- When using the snow chains.
- When driving in deep snow or on soft terrain.
- When the vehicle is bogged-down, to free it by “rocking it”.

The ASR should be switched on again as soon as possible.

Control lamp

There are three control lamps for the traction control system:  (for vehicles equipped with M-ABS),  (for vehicles equipped with ESC) and . Both control lamps light up together when the ignition is switched on and should turn off after approximately 2 seconds, which is the time taken for the function check.

The  or  lamp has the following function:

- It flashes when the ASR is working if the vehicle is moving.

If the system is deactivated or if it has any fault, the warning lamp will remain lit. The warning lamp will also light up if a fault should occur in the ABS because the ASR operates in conjunction with the ABS. For further information, see » page 185.

The lamp provides information about the disconnection status of the system:*

- It stays lit when the ASR is disconnected via Easy Connect.

By means of Easy Connect, the ASR function is reactivated and the warning lamp switched off.

WARNING

- Remember that not even the ASR can defy the laws of physics. Bear this in mind, particularly on slippery and wet roads and when towing a trailer.
- Always adapt your driving style to suit the condition of the roads and the traffic situation. The greater safety provided by the ASR should not encourage you to run any risks.

CAUTION

- To ensure that the ASR works correctly, identical tyres should be fitted on all four wheels. Any differences in the rolling radius of the tyres can cause the system to reduce engine power when this is not desired.

- Any modifications made to the vehicle (for example, to the engine, brake system, running gear or to the combination of wheels and tyres) may affect the operation of the ABS and ASR.

Connecting/disconnecting ESC and ASR*

The ESC is switched on automatically when the engine is started, and only works when the engine is running and includes the ABS, EDS and ASR systems.

The ASR and ESC function should only be switched off in situations in which traction is insufficient, among others:

- When driving in deep snow or on surfaces that are not very firm.
- To “free” the vehicle if it gets stuck.

Then switch the ASR and ESC function back on.

Depending on finishes and versions, it is possible either to disconnect only the ASR or else activate ESC Sport mode.

ESC in “Sport” mode

Sport mode can be connected via the Easy Connect » page 123 system menu. The ESC and the traction control system (ASR) have only a limited ability to stabilise the vehicle.

The control lamp  lights up. For vehicles with a driver information system*, the driver will be shown the **electronic stability control (ESC) option: sport. Warning! Limited stability.**

Disable ESC “Sport” mode

Through the Easy Connect system menu » page 123. The warning lamp  will switch off. For vehicles with a driver information system*, the driver will be shown the **electronic stability control (ESC) option: on.**

Disable ASR

The Easy Connect system menu is used to switch off the ASR » page 123. The traction control system will be disabled.

The control lamp  lights up. For vehicles with a driver information system* the driver will be informed that **ASR is disabled.**

Activate ASR

The Easy Connect system menu » page 123 is used to switch on the ASR. The traction control system will be enabled.

The control lamp  switches off. For vehicles with a driver information system* the driver will be informed that **ASR is enabled.**

- Activate or deactivate the ASR or ESC function in the Easy Connect system by means of »

the **CAR** button and the **SETTINGS** and **ESC System** function buttons.

WARNING

You should switch on the ESC Sport mode only if the traffic conditions and your driving ability allow you to do so safely: risk of skidding!

- With ESC in Sport mode, the stabilising function will be limited to allow for a sportier drive. The driving wheels could spin and the vehicle could skid.

Note

If the ASR is disconnected or the ESC's Sport mode is selected, cruise control* will be switched off.

Electronic differential lock (EDS)*

The EDL operates along with the ABS in vehicles equipped with Electronic Stability Control (ESC)*.

EDL helps the vehicle to start moving, accelerate and climb a gradient in slippery conditions where this may otherwise be difficult or even impossible.

It uses the ABS sensors to monitor the speed of the driven wheels.

At speeds of up to approximately 80 km/h (50 mph), it is able to balance out differences

in the speed of the driven wheels of approximately 100 rpm/min caused by a *partially* slippery road surface. It does this by braking the wheel which has lost traction and distributing more driving force to the other driven wheel via the differential.

To prevent the disc brake of the braking wheel from overheating, the EDL cuts out automatically if subjected to excessive loads. The vehicle will continue to function normally without EDL. For this reason, the driver is not informed that the EDL has been switched off.

The EDL will switch on again automatically when the brake has cooled down.

Control lamp

A malfunction in the EDL is indicated by the ESC control lamp . Take the vehicle to a specialised workshop as soon as possible.

WARNING

- **When accelerating on a slippery surface, for example on ice and snow, press the accelerator carefully. Despite EDL, the driven wheels may start to spin. This could impair the vehicle's stability.**
- **Always adapt your driving style to suit road conditions and the traffic situation. Do not let the extra safety afforded by EDL tempt you into taking any risks when driving, this can cause accidents.**

CAUTION

Modifications to the vehicle (e.g. to the engine, the brake system, running gear or any components affecting the wheels and tyres) could affect the efficiency of the EDL
» page 247.

Hydraulic Brake Assist (HBA)*

The function (Hydraulic Brake Assist HBA) is only included in vehicles with ESC.

In an emergency, most drivers brake in time, but not with maximum force. This results in unnecessarily long braking distances.

This is when the brake assist system comes into action. When pressing the brake pedal rapidly, the assistant interprets it as an emergency. It very quickly builds up the full brake pressure so that the ABS can be activated more quickly and efficiently, thus reducing braking distance.

Do not reduce the pressure on the brake pedal, since the brake assist system switches off automatically as soon as you release the brake.

Automatic hazard warning lights activation

The brake lights flash automatically to indicate that the vehicle is braking suddenly or in an emergency situation. If the emergency braking continues until the vehicle comes to

a standstill, the hazard warning lights will then come on and the brake lights will remain on permanently from that moment. The warning lights will automatically switch off when the vehicle begins to move again or when the "warning" light button is pressed.

WARNING

- **The risk of accident is higher if you drive too fast, if you do not keep your distance from the vehicle in front, and when the road surface is slippery or wet. The increased accident risk cannot be reduced by the brake assist system.**
- **The brake assist system cannot defy the laws of physics. Slippery and wet roads are dangerous even with the brake assist system! Therefore, it is essential that you adjust your speed to suit the road and traffic conditions. Do not let the extra safety features tempt you into taking any risks when driving.**

Anti-lock brake System (ABS)

The anti-lock brake (ABS) system prevents the wheels from locking during braking and is an important part of the vehicle's active safety system.

How the ABS works

If one of the wheels turns too slowly in relation to the vehicle's speed, and is close to locking, the system will reduce the braking

pressure to this wheel. The driver is made aware of this control process by a **pulsating of the brake pedal** and audible noise. This is a deliberate warning to the driver that one or more of the wheels is tending to lock and the ABS control function has intervened. In this situation it is important to keep the brake pedal fully depressed so the ABS can regulate the brake application. Do not "pump".

If you brake hard on a slippery road surface, the best possible control is retained as the wheels do not lock.

However, ABS will not necessarily guarantee shorter braking distances in *all* conditions. Braking distance could even be further if you brake on gravel or on fresh snow on a slippery surface.

Control lamp

The control lamp  lights up for a few seconds when the ignition is switched on. It goes out again after the system has run through an automatic test sequence.



There is a fault in the ABS if:

- The control lamp  does not light up when the ignition is switched on.
- The control lamp does not go out again after a few seconds.
- The control lamp lights up when the vehicle is moving.

The vehicle can still be braked in the normal way, without the ABS function. Take the vehicle to a specialised workshop as soon as possible.

If there is a fault in the ABS, the ESC* and the tyre pressure control lamp will also light up.

Brake system fault

If the ABS warning lamp  lights up together with the brake warning lamp , there is a fault in the ABS function and in the brake system .

WARNING

- **The anti-lock brake system cannot defy the laws of physics. Slippery and wet roads are dangerous even with ABS! If you notice that the ABS is working (to counteract locked wheels under braking), you should reduce speed immediately to suit the road and traffic conditions. Do not let the extra safety features tempt you into taking any risks when driving.**
- **The effectiveness of ABS is also determined by the tyres fitted  page 274.**
- **If the running gear or brake system is modified, the effectiveness of the ABS could be severely limited.**

⚠ WARNING

- Before opening the bonnet, read and observe the warnings » page 263, Working in the engine compartment.
- If the brake system warning lamp (🚗) should light up together with the ABS warning lamp (🚗), stop the vehicle immediately and check the brake fluid level in the reservoir » page 271, Brake fluid. If the brake fluid level has dropped below the “MIN” mark you must not drive on. Risk of accident. Obtain technical assistance.
- If the brake fluid level is correct, the fault in the brake system may have been caused by a failure of the ABS system. This could cause the rear wheels to lock quickly when you brake. This could cause the rear to break away. Risk of skidding. Stop the vehicle and seek technical assistance.

Electronic differential lock (XDS)*

When taking a curve, the driveshaft differential mechanism allows the outer wheel to turn at a higher speed than the inner wheel. In this way, the wheel that is turning faster (outer wheel) receives less drive torque than the inner wheel. This may mean that in certain situations the torque delivered to the inner wheel is too high, causing the wheels to spin. On the other hand, the outer wheel is receiving a lower drive torque than it could transmit. This causes an overall loss of lateral

grip on the front axle, resulting in understeer or “lengthening” of the trajectory.

The XDS system can detect and correct this effect via the sensors and signals of the ESC.

Via the ESC, the XDS will brake the inside wheel and counter the excess driving torque of that wheel. This means that the driver’s desired trajectory is much more precise.

The XDS system works in combination with the ESC and is always active, even when ASR traction control is disconnected or the ESC is in Sport mode.

Multi-collision Brake

In an accident, the multi-collision brake can help the driver by braking to avoid the risk of skidding during the accident, which could lead to further collisions.

The multi-collision brake works for front, side or rear accidents, when the airbag control unit records its activation level and the accident takes place at a speed of over 10 km/h (6 mph). The ESC automatically brakes the vehicle, as long as the accident has not damaged the ESC, the brake hydraulics or the on-board network

The following actions control automatic braking during the accident:

- When the driver presses the accelerator, the automatic braking does not take place.
- When the braking pressure through pressing the brake pedal is greater than the system’s braking pressure the vehicle will brake automatically.
- Multi-collision braking will not be available if ESC is malfunctioning.

Brake servo

The brake servo increases the pressure you apply to the brake pedal. It works **only when the engine is running**.

If the brake servo is not functioning, e.g. due to a malfunction, or if the vehicle is being towed, you will have to press the brake pedal considerably harder to make up for the lack of servo assistance.

⚠ WARNING

The braking distance can also be affected by external factors.

- **Never let the vehicle coast with the engine switched off. Failure to follow this instruction could result in an accident. The braking distance is increased considerably when the brake servo is not active.**
- **If the brake servo is not working, for example when the vehicle is being towed, you will have to press the brake pedal considerably harder than normal.**

Hill driving assistant*



BKI-0099

Fig. 181 Related video

This function is only included in vehicles with ESC.

The hill driving assistant helps the driver to move off and upward on a hill when the vehicle is stationary.

The system maintains brake pressure for approximately two seconds after the driver takes his foot off the brake pedal to prevent the vehicle from lurching backward when it is started. During these 2 seconds, the driver has enough time to release the clutch pedal and accelerate without the vehicle moving and without having to use the handbrake, making start-up easier, more comfortable and safer.

These are the basic operation conditions:

- being on a ramp or hill/slope,
- driver door closed,
- vehicle completely stationary,
- engine running and foot on the brake,

- besides having a gear engaged or being in neutral for manual gear change and with the selector lever at position **S**, **D** or **R** for an automatic gearbox.

This system is also active when reversing uphill.

⚠ WARNING

- **If you do not start the vehicle immediately after taking your foot off the brake pedal, the vehicle may start to roll back under certain conditions. Depress the brake pedal or use the hand brake immediately.**
- **If the engine stalls, depress the brake pedal or use the hand brake immediately.**
- **When following a line of traffic uphill, if you want to prevent the vehicle from rolling back accidentally when starting off, hold the brake pedal down for a few seconds before starting off.**

i Note

The Official Service or a specialist workshop can tell you if your vehicle is equipped with this system.

Manual gearbox

Driving with a manual gearbox

Read the additional information carefully

» page 50

Certain versions of the model may include a 6-speed manual gearbox, and its diagram is shown on the gearbox lever.

The reverse gear can only be engaged when the car is stationary. When the engine is running and before engaging this gear, wait about 6 seconds with the clutch pressed down thoroughly in order to protect the gearbox.

The reverse lights switch on when the reverse gear is selected and the ignition is on.

⚠ WARNING

- **When the engine is running, the vehicle will start to move as soon as a gear is engaged and the clutch released.**
- **Never select the reverse gear when the vehicle is in motion. Risk of accident.**

i Note

- **Do not rest your hand on the gear lever while driving. The pressure of your hand could cause premature wear on the selector forks in the gearbox.**

»

- When changing gear, you should always depress the clutch fully to avoid unnecessary wear and damage.
- Do not “slip” the clutch to hold the vehicle on a hill. This causes premature wear and damage to the clutch.
- Do not leave your foot on the clutch pedal; although the pressure may seem insignificant, it can cause the premature wear of the clutch plate. Use the foot rest when you do not need to change gear.

Automatic gearbox/DSG automatic gearbox*

Introduction

Your vehicle is equipped with an electronically controlled manual gearbox. Torque between the engine and the gearbox is transmitted via two independent clutches. They replace the torque converter found on conventional automatic gearboxes and allow for smooth, uninterrupted acceleration of the vehicle.

The **tiptronic** system allows the driver to change gears *manually* if desired
 »» page 192, Engaging gears with the tiptronic mode*.

Selector lever positions

Read the additional information carefully
 »»  page 50

The selector lever position engaged is highlighted on the display in the instrument cluster. With the selector lever in the manual gearbox positions G, D, E and S, the engaged gear is also indicated on the display.

P – Parking lock

When the selector lever is in this position, the driven wheels are locked mechanically. The parking lock must be engaged only when the vehicle is *stationary* »» .

The interlock button (the button on the selector lever handle) must be pressed in *and* simultaneously the brake pedal must be depressed before moving the selector lever either in or out of position P.

R – Reverse gear

Reverse gear must be engaged only when the vehicle is *stationary* and the engine is idling
 »» .

To move the selector lever to position R, the interlock button must be pressed in *and* at the same time the brake pedal must be depressed. The reverse lights come on when the selector lever is in the R position with the ignition on.

N – Neutral (idling)

With the selector lever in this position, the gear is in neutral.

D/S – Permanent drive (forward) position

The selector lever in the D/S position enables the gears to be controlled in normal mode (D) or Sport (S). To select Sport mode (S), move the selector lever backwards. Moving the lever again will select normal mode (D). The selected driving mode is shown on the instrument panel display.

In **normal mode** (D), the gearbox automatically selects the best gear ratio. This depends on the engine load, the road speed and the dynamic gear control programme (DCP).

Sport mode (S) must be selected for a sporty driving style. This setting makes use of the engine's maximum power output. When accelerating the gear shifts will be noticeable.

Press the brake pedal to move the selector lever from N to D/S when the vehicle is stationary or at speeds below 3 km/h (2 mph)
 »» .

Under certain circumstances (e.g. when driving in mountains) it can be advantageous to switch temporarily to tiptronic mode
 »» page 192, in order to *manually select* gear ratios to suit the driving conditions.

⚠ WARNING

- Take care not to accidentally press the accelerator pedal when the vehicle is stopped. The vehicle could otherwise start moving immediately (in some cases even if the parking brake is engaged) resulting in the risk of an accident.
- Never move the selector lever to R or P when driving. Failure to follow this instruction could result in an accident.
- With selector lever in any position (except P) the vehicle must always be held with the foot brake when the engine is running. This is because an automatic gearbox still transmits power even at idling speed, and the vehicle tends to “creep”. The accelerator pedal must on no account be pressed inadvertently when a gear is engaged with the vehicle stationary. The vehicle could otherwise start moving immediately (in some cases even if the parking brake is engaged) resulting in the risk of an accident.
- While you are selecting a gear and the vehicle is stopped with the engine running, do not accelerate. Failure to follow this instruction could result in an accident.
- As a driver you should never leave your vehicle if the engine is running and a gear is engaged. If you have to leave your vehicle while the engine is running, you must apply the handbrake and engage the parking lock (P).
- To avoid accidents, apply the handbrake and put the selector lever in position P before opening the bonnet and working on the vehi-

cle with the engine running. Please always observe the important safety warnings » page 263, Working in the engine compartment.

i Note

- If the selector lever is moved accidentally to N when driving, release the accelerator and let the engine speed drop to idling before selecting gear range D or S again.
- Should the power supply to the selector lever be interrupted in position P, the selector lever will be locked. If this should happen the manual release can be used »  page 50.

Selector lever lock

Fig. 182 Selector lever lock.

The selector lever lock prevents gears from being engaged inadvertently, so that the vehicle is not set in motion unintentionally.

The selector lever lock is released as follows:

- Switch the ignition on.
- Press the brake pedal *and*, at the same time, hold the lock button in the direction of the arrow » **Fig. 182**.

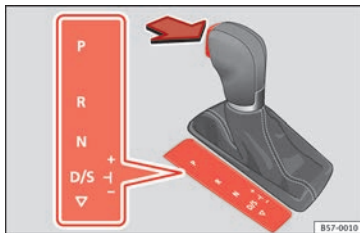
Automatic selector lever lock

With the ignition switched on, the selector lever is locked in the positions P and N. The brake pedal must be pressed to release the lever while pressing the release button if the selector lever is in the position P. As a reminder for the driver, with the lever in positions P or N the following message will be shown on the display:

When stationary, apply footbrake while selecting a gear.

Level lock only engages with the vehicle stationary and at speeds of up to 5 km/h (3 mph). At speeds of over 5 km/h (3 mph) the lever lock is automatically deactivated in position N.

The selector lever lock is not engaged if the selector lever is moved quickly through position N (e.g. when shifting from R to D). This makes it possible, for instance, to rock the vehicle “backwards and forwards” if it is stuck. The selector lever lock engages automatically if the brake pedal is not depressed and the lever is in position N for more than about two seconds.

Interlock button

The interlock button on the selector lever handle prevents the driver from inadvertently engaging certain gears. Press the button in to disengage the selector lever lock.

Safety interlock for ignition key

Once the ignition has been turned off, the key may be removed only if the gear selector is in position P. While the key is not in the ignition, the selector lever is locked in position P.

Note

- If the selector lever lock does not engage, there is a fault. The transmission is interrupted to prevent the vehicle from accidentally moving. Follow the procedure below in order for the selector lever lock to engage again:
 - With a 6-speed gearbox: press the brake pedal and release it again.
 - With a 7-speed gearbox: press the brake pedal. Move the selector lever to position P or N and subsequently engage a gear.
- Despite a gear being engaged, the vehicle does not move forwards or back. Proceed to the next mode:
 - When the vehicle does not move in the required direction, the system may not have the gear range correctly engaged. Press the brake pedal and engage the gear range again.

- If the vehicle still does not move in the required direction, there is a system malfunction. Seek specialist assistance and have the system checked.

Engaging gears with the tiptronic mode*

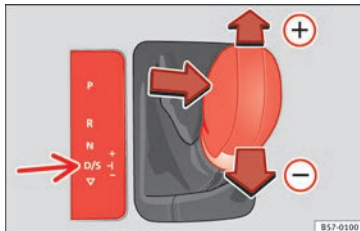

Fig. 183 Centre console: changing gear with tiptronic

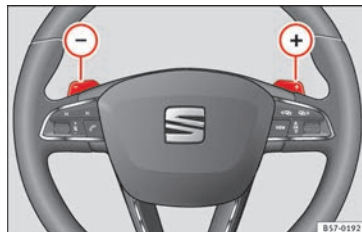



Fig. 184 Steering wheel: automatic gearbox levers

The tiptronic gives the driver the option to change gears manually.



Changing gear manually with the selector lever

It is possible to change to tiptronic mode, both when the vehicle is stopped and while driving.

- To switch to tiptronic mode, move the selector lever from position D/S to the right. As soon as the change is made the selector level will be shown in the position M on the instrument panel display (for example M4 means that the fourth gear is engaged).
- Move the selector lever forwards  to select a higher gear **» Fig. 183**.
- Move the selector lever backwards  to select a lower gear.

Changing gear manually with the gearshift paddles*

The gearshift paddles can be used when the selector lever is in the position D/S or M.

- Press the gearshift paddle  to select a higher gear » **Fig. 184.**
- Press the gearshift paddle  to select a lower gear.
- With the selector lever in position D/S, if no paddle is operated during a short period of time, the gearbox control system switches back to automatic mode. To switch to permanent manual gear change using the gearshift paddles, move the selector lever from position D/S to the right.

When accelerating, the gearbox automatically shifts up into the next gear shortly before the maximum engine speed is reached.

If you select a lower gear, the automatic gearbox will not shift down until there is no risk of over-revving the engine.

When the kick-down feature is used, the gearbox shifts down to a lower gear, depending on road speed and engine speed.

Driving tips

The gearbox changes gear ratios automatically as the vehicle moves.

The engine can only start with the selector lever in position P or N. At low temperatures, below -10°C (14°F), the engine can only start with the selector lever in position P.

Starting the vehicle

- Press and hold the brake pedal.
- Press and hold the interlock button (the button on the selector lever handle), move the selector lever to the desired position, for instance **D** » **page 190**, and release the interlock button.
- Wait for the gearbox to engage the gear (a slight movement can be felt).
- Release the brake and press the accelerator » .

Stopping briefly

- Apply the foot brake to hold the vehicle briefly when stationary (for instance at traffic lights). Do not press the accelerator.



Stopping/Parking

If the driver door is opened and the selector lever is not in position P, the vehicle could move. The driver message will be:  **Gear change: selector lever in the drive position!**. Additionally, a buzzer will sound.

- Press and hold the brake pedal » .
- Apply the handbrake.

- Move the selector lever to position P.

Holding the car on a hill

- *Always* apply the brake pedal firmly to prevent the vehicle “from moving backwards”; if necessary, apply the handbrake »  **Δ**. Do **not** try to stop the vehicle “rolling back” by increasing the engine speed (pressing the accelerator) when a gear is engaged »  **!**.

Starting off uphill

- Apply the handbrake.
- Once you have engaged a gear press the accelerator carefully and disengage the handbrake.

Driving down hills: in some situations (on mountain roads or when towing a trailer or caravan) it can be advantageous to switch temporarily to the manual gearbox programme so that the gear ratios can be selected manually to suit the driving conditions »  **Δ**.

On level ground it is sufficient to move the selector lever to position P. On slopes, first engage the parking brake and then put the selection lever into the P position. This avoids overloading the locking mechanism and it will be easier to move the selector lever from position P.

»

⚠ WARNING

Observe the safety warnings »  in Selector lever positions on page 191.

- Never allow the brake to rub and do not use the brake pedal too often or for long periods. Constant braking causes overheating in the brakes. This could significantly reduce braking power, increase braking distance or even result in the total failure of the brake system.
- To avoid rolling back on gradients always hold the vehicle with the footbrake or handbrake if you have to stop.

ⓘ CAUTION

- If you stop the vehicle on a gradient, do not attempt to stop it from rolling by depressing the accelerator when a gear has been selected. This could cause overheating and damage the automatic gearbox. Apply the handbrake firmly or press the brake pedal in order to prevent the vehicle from rolling back.
- If you allow the car to roll with the selector lever in position N with the engine switched off, the automatic gearbox will be damaged as it will not be lubricated.
- In certain driving situations or traffic conditions, such as frequently starting, prolonged “creeping” of the vehicle or traffic jams with continuous stoppages, the gearbox could

overheat causing damage! If the warning lamp  lights up, stop the vehicle as soon as possible and wait for the gearbox to cool » page 196.

Kick-down feature

The kick-down feature allows maximum acceleration to be reached.

When the accelerator pedal is pressed right down past the point of resistance at full throttle, the gearbox will shift down to a lower gear, depending on road speed and engine speed. The upshift to the next higher gear is delayed until the engine reaches maximum rpm.

⚠ WARNING

Please note that if the road surface is slippery or wet, the kick-down feature could cause the driving wheels to spin, which could result in skidding.

Launch control program

✓ Valid for vehicles: with Launch-Control/6-Speed DSG with diesel engines superior to 125 kW and petrol engines superior to 140 kW.

The Launch control programme enables maximum acceleration.

Important: the engine must have reached operating temperature and the steering wheel must not be turned.

The engine speed for launch-control is different on petrol and diesel engines. To use the launch-control you must disconnect the anti-slip regulation (ASR) through the Easy Connect system menu » page 123. The warning lamp  will stay switched on or will flash slowly depending on whether or not the vehicle has a driver information system*.

On vehicles with the driver information system, the ESC lamp lights up permanently and the corresponding text message **Stability control deactivated** (temporary) appears on the instrument panel to indicate the deactivation status.

– When the engine is running, switch off the traction control (ASR)¹⁾.

¹⁾ Vehicles without driver information system: the warning lamp flashes slowly/Vehicles with driver information system: the warning lamp stays on.

- Turn the selector lever to the position “S” or tiptronic, or else select the **sport** driving mode from the SEAT Drive Profile*
» page 225.
- Press the brake pedal firmly with your left foot and hold it down for at least one second.
- With your right foot, press the accelerator down to the full throttle or kick-down position. The engine speed will stabilise at about **3,200 rpm** (petrol engine) or about **2,000 rpm** (diesel engine).
- Take your left foot off the brake pedal.

WARNING

- Always adapt your driving style to the traffic conditions.
- Only use the launch control programme when road and traffic conditions permit, and make sure your manner of driving and accelerating the vehicle does not inconvenience or endanger other road users.
- Make sure that the ESC remains switched on. Please note that when the ASR and ESC are deactivated, the wheels may start to spin, causing the vehicle to lose grip. Risk of accident!
- After moving off, the ESC “sport” mode should be deactivated by briefly pressing the  OFF button.

Note

- After using the Launch control programme, the temperature in the gearbox may have increased considerably. In this case, the programme could be disabled for several minutes. The programme can be used again after the cooling phase.
- Accelerating with the Launch control programme places a heavy load on all parts of the vehicle. This can result in increased wear and tear.

Downhill speed control*

The downhill speed control function helps the driver when driving down steep gradients.

Downhill speed control is activated when the selector lever is in D/S and the driver applies the foot brake. The automatic gearbox automatically engages a lower gear that is suitable for the slope. The downhill speed control function attempts to maintain the speed at which the vehicle was travelling when the foot brake was applied (subject to the laws of physics and technical drive limitations). It may be necessary to adjust the speed again using the foot brake in certain situations. Given that the downhill speed control can only change down to 3rd gear, on very steep descents the tiptronic mode may be required. In this case, manually reduce the tiptronic to

2nd or 1st gear to use the engine brake and reduce the charge on the brakes.

Downhill speed control is deactivated as soon as the road levels out again or you press the accelerator pedal.

On vehicles with cruise control system*
» page 207, downhill speed control is activated when you set a cruising speed.

WARNING

The downhill speed control cannot defy the laws of physics. Therefore, speed cannot be maintained constant in all situations. Always be prepared to use the brakes!

Inertia mode

The inertia mode enables the kinetic energy of the vehicle to be harnessed enabling certain stretches to be driven without using the accelerator. This enables fuel to be saved. Use the inertia mode to “let the vehicle roll” before, for example, arriving in a town.

Switching on inertia mode

Important: selector lever must be in position D, gradients below 12 %.

- Select, in SEAT Drive Profile*, **Eco** mode
» page 225.
- Take your foot off the accelerator.



The driver message **Inertia** will be displayed. At speeds higher than 20 km/h (12 mph), the gearbox will automatically disengage and the vehicle will roll freely, without the effect of the engine brake. While the vehicle rolls, the engine runs at idling speed.

Stopping inertia mode

– Press the brake or the accelerator pedal.

To make use of the braking force and switch off the engine again, simply press the brake pedal briefly.

Applying both the **inertia mode** (= prolonged section with less energy) and the **switching off using inertia** (= shorter section without the need for fuel) facilitates improved fuel consumption and emission balance.

WARNING

- If the inertia mode has been switched on, take into account, when approaching an obstacle and releasing the accelerator pedal, that the vehicle will not decelerate in the usual manner: risk of accident!
- When using inertia mode while travelling down hills, the vehicle can increase speed: risk of accident!
- If other users drive your vehicle, warn them about inertia mode.

Note

- Inertia mode is only available in eco (SEAT Drive Profile*) driving mode.
- The driver message **Inertia** is only displayed with the current consumption. In inertia mode the gear will no longer be displayed (for example “E” will appear instead of “E7”).
- On downhill sections with gradients above 15 %, the inertia mode will automatically be switched off temporarily.

Emergency program

A backup programme is in place if a fault should occur in the control system.

If all the positions of the selector lever are shown over a light background on the instrument panel display, there is a system fault and the automatic gearbox will operate in with the backup programme. When the backup programme is activated, it is possible to drive the vehicle, however, at low speeds and within a selected range of gears. In some cases **driving in reverse gear may not be possible**.

CAUTION

If the gearbox operates with the backup programme, take the vehicle to a specialised workshop and have the fault repaired without delay.

Clutch

Clutch overheating! Please stop!

The clutch has overheated and could be damaged. Stop the vehicle and wait for the gearbox to cool with the engine at idling speed and the selector lever in position P. When the warning lamp and the driver message switch off, have the fault corrected by a specialised workshop without delay. If the warning lamp and the driver message do not switch off, do not continue driving. Seek specialist assistance.

Gearbox malfunctions

Gearbox: Fault! Stop the vehicle and place the lever in the position P.

There is a fault in the gearbox. Stop the vehicle in a safe place and do not continue driving. Seek specialist assistance.

Gearbox: System fault! You may continue driving.

Have the fault corrected by a specialised workshop without delay.

Gearbox: System fault! You can continue driving with restrictions. Reverse gear disabled

Take the vehicle to a specialised workshop and have the fault repaired without delay.

ⓘ Gearbox: System fault! You can continue driving in D until switching off the engine

Stop the vehicle in a safe place well away from moving traffic. Seek specialist assistance.

ⓘ Gearbox: too hot. Adapt your driving accordingly

Continue driving at moderate speeds. When the warning lamp switches off, you can continue driving in a normal manner.

ⓘ Gearbox: press the brake and engage a gear again.

If the fault was caused by a gearbox with a high temperature, this driver message will be displayed when the gearbox has cooled again.

Gear-change indicator

Selecting the optimal gear

While driving, and depending on vehicle equipment, the instrument panel display may show a recommendation with the gear number that would be advisable to save fuel.

In vehicles with an *automatic gearbox*, the selector lever must be in the tiptronic position » page 192.

No recommendation will appear if the optimal gear is already engaged. The current gear will be displayed.

Display	Meaning
3	The optimal gear is selected.
4 ► 5	Changing to a higher gear is recommended.
2 ► 1	Changing to a lower gear is recommended.

Information regarding the “cleanliness” of the diesel particulate filter

The exhaust system manager detects that the diesel particulate filter is nearly saturated and contributes to self-cleaning by recommending the optimal gear. For this reason, it might be necessary to drive for a short time at a high rpm.

⚠ WARNING

The gear change indicator is only an auxiliary function and in no case should be a substitute for careful driving.

- **The responsibility of choosing the correct gear depending on the situation (e.g. overtaking, driving up or down a slope or towing a trailer) lies with the driver.**

🌱 For the sake of the environment

Selecting the correct gear can help to save fuel.

📄 Note

The recommended gear indication turns off when the clutch pedal is pressed in vehicles with manual gearbox or when the selector lever is removed from the tiptronic position in vehicles with an automatic gearbox.

Steering

Introduction

The power steering is not hydraulic but electromechanical. The advantage of this steering is that it does not need flexible hydraulic pipes, hydraulic oil, pump, filter or other parts. The electromechanical system saves fuel. Whereas a hydraulic system needs continuous oil pressure, electromechanical steering only needs power when it is used.

In vehicles with electromechanical steering, the assisted steering function automatically adjusts according to vehicle speed, steering wheel torque and wheel orientation. The power steering only works when the engine is running.

WARNING

If the power steering does not work, you will need much more strength to turn the wheel. This has a considerable effect on vehicle safety.

- The power steering only works when the engine is running.
- Never allow the vehicle to move when the engine is switched off.
- Never remove the key from the ignition while the vehicle is moving. The steering lock could be engaged and vehicle steering would not work.

Note

The ignition of the vehicle being towed must be switched on to prevent the steering wheel from locking and also to allow the use of the turn signals, horn, windscreen wipers and washers.

Control lamp

The control lamp should light up for a few seconds when the ignition is switched on. It should go out once the engine is started.



It lights up red

The electromechanical steering is damaged.

Have the steering checked immediately by a specialised workshop.



It lights up yellow

Electromechanical steering operation is limited.

See a specialised workshop immediately and have the steering checked.
If the yellow warning lamp does not light up again after the engine is restarted and the vehicle has travelled a short distance, you do **not** need to take it to a specialised workshop.

The 12-volt battery was disconnected and has been reconnected.

Take the vehicle for a short run at 15-20 km/h (9-12 mph).



It flashes yellow

The steering column is tight.

Turn the wheel a little to both sides.

The steering column does not unlock or lock.

Remove the key from the ignition and switch the ignition back on. If necessary, check the messages displayed on the instrument panel display.
Do not drive on if the steering column remains locked after the ignition has been switched on. Seek specialist assistance.

WARNING

If the warning lamps and the corresponding messages are ignored when they light up, the vehicle may stall in traffic and cause accidents and severe injuries.

- Never ignore the warning lamps or messages.
- Stop the vehicle at the next opportunity and in a safe place.

Note

Failure to heed the control lamps and corresponding text messages when they light up may result in damage to the vehicle.

Information relating to different vehicle processes.

In order to make the vehicle more difficult to steal, you should always lock the steering before leaving the vehicle.

Mechanical steering lock

The steering column is locked when the key is removed from the ignition lock and the vehicle is stationary.

Activating the steering lock

- Park the vehicle » page 181.
- Remove the ignition key.
- Turn the steering wheel slightly until the steering lock has engaged.

Deactivating the steering lock

- Turn the steering wheel slightly to release the lock.
- Insert the key in the ignition lock.
- Hold the steering wheel in this position and switch on the ignition.

Electromechanical steering

In vehicles with electromechanical steering, the assisted steering function automatically adjusts according to vehicle speed, steering wheel torque and wheel orientation. The power steering only works when the engine is running.

You should take into account that you will need considerably more power than normal to steer the vehicle if the power steering is not working correctly or at all.

Power-assisted steering

Power-assisted steering helps the driver in critical situations. In counter-steering, it assists by applying additional torque » .

WARNING

Power-assisted steering, together with the ESC, helps the driver to control vehicle steering in critical situations. However, the driver is ultimately responsible for steering the vehicle at all times. Power-assisted steering does not remove this responsibility.

Run-in and economical driving

Running in a new engine

The engine needs to be run-in over the first 1500 km (900 miles).

For the first 1,000 kilometres (600 miles)

- Do not drive at speeds of more than 2/3 the maximum speed.
- Do not accelerate hard.
- Avoid high engine revolutions.
- Do not tow a trailer.

From 1,000 kilometres (600 miles) to 1,500 kilometres (900 miles)

- Speeds can be *gradually* increased to the maximum road speed or maximum permissible engine speed (rpm).

During its first few hours of running, the internal friction in the engine is greater than later on, when all the moving parts have bedded in.

For the sake of the environment

If the engine is run in gently, its life will be increased and its oil consumption reduced.

Running in tyres and brake pads

New tyres should be run in carefully for the first 500 km (300 miles) and new brake pads should be run in carefully for the first 200 km (125 miles).

During the first 200 km (125 miles) you have to compensate for the reduced braking effect by applying more pressure to the brake pedal. In case of a sharp braking, the braking distance will be longer with new brake pads than with brake pads which have been run-in.

WARNING

- At first, new tyres do not give maximum grip, and require running-in. This may cause an accident. Drive particularly carefully in the first 500 km (300 miles).
- New brake pads must be “run in” and do not have the correct friction properties during the first 200 km (125 miles). However, the reduced braking capacity may be compensated by pressing on the brake pedal a little harder.

Environmental compatibility

Environmental protection is a top priority in the design, choice of materials and manufacture of your new SEAT. »

Constructive measures to encourage recycling

- Joints and connections designed for easy dismantling.
- Modular construction to facilitate dismantling.
- Increased use of single-grade materials.
- Plastic parts and elastomers are marked in accordance with ISO 1043, ISO 11469 and ISO 1629.

Choice of materials

- Use of recycled materials.
- Use of compatible plastics in the same part if its components are not easily separated.
- Use of recycled materials and/or materials originating from renewable sources.
- Reduction of volatile components, including odour, in plastic materials.
- Use of CFC-free coolants.

Ban on heavy metals, with the exceptions dictated by law (Annex II of ELV Directive 2000/53/EC): cadmium, lead, mercury, hexavalent chromium.

Manufacturing methods

- Reduction of the quantity of thinner in the protective wax for cavities.
- Use of plastic film as protection during vehicle transport.

- Use of solvent-free adhesives.
- Use of CFC-free coolants in cooling systems.
- Recycling and energy recovery from residues (RDF).
- Improvement in the quality of waste water.
- Use of systems for the recovery of residual heat (thermal recovery, enthalpy wheels, etc.).
- The use of water-soluble paints.

Economical and environmentally-friendly driving

Fuel consumption, environmental pollution and wear to the engine, brakes and tyres depends in large part on your driving style. By adopting an economical driving style and anticipating the traffic situation ahead, you can easily reduce fuel consumption by 10-15%. Some tips on how to help you reduce pollution while saving money are listed below.

Active cylinder management (ACT®)*

Depending on vehicle equipment, the active cylinder management (ACT®) may automatically deactivate some of the engine cylinders if the driving situation does not require too much power. When it is switched off, no fuel is injected into these cylinders, hence total fuel consumption may be reduced. The num-

ber of active cylinders can be seen on the instrument panel display. »  page 38.

Drive anticipating the traffic situation

A vehicle uses most fuel when accelerating. When you anticipate situations, you have to brake less often and, thus, accelerate less. If it is possible, let the vehicle roll with a **gear engaged**, for example, if you see a red light ahead. The braking effect achieved in this way helps to reduce the wear of brakes and tyres; emissions and fuel consumption are reduced to zero (disconnection due to inertia).

Change gear early to save energy

An effective way of saving fuel is to change up *quickly* through the gears. Running the engine at high rpm in the lower gears uses an unnecessary amount of fuel.

Manual gearbox: shift up from first to second gear as soon as possible. We recommend that, whenever possible, you change to a higher gear upon reaching 2000 rpm. Follow the “recommended gear” indication that appears on the instrument panel » [page 197](#).

Avoid driving at high speed

We advise you not to drive at the top speed permitted by the vehicle. Fuel consumption,

exhaust emissions and noise levels all increase very rapidly at higher speeds. Driving at moderate speeds will help to save fuel.

Avoid idling

It is worthwhile switching off the engine when waiting in a traffic jam, at level crossings or at traffic lights with a long red phase. The fuel saved after only 30 - 40 seconds is greater than the amount of fuel needed to restart the engine.

The engine takes a long time to warm up when it is idling. Mechanical wear and pollutant emissions are also especially high during this initial warm-up phase. It is therefore best to drive off immediately after starting the engine. Avoid running the engine at high speed.

Periodic maintenance

Periodic maintenance work guarantees that, before beginning a journey, you will not consume more than the required amount of fuel. A well-serviced engine gives you the benefit of **improved fuel efficiency** as well as maximum reliability and an enhanced resale value.

A badly serviced engine can consume up to 10% more fuel than necessary.

Avoid short journeys

To reduce the consumption and emission of polluting exhaust gases, the engine and the exhaust gas filtration systems should reach the optimum **operating temperature**.

With the engine cold, fuel consumption is proportionally higher. The engine does not warm up and fuel consumption does not normalise until having driven approximately *four* kilometres (2.5 miles). This is why we recommend avoiding short trips whenever possible.

Maintain the correct tyre pressures

Bear in mind that keeping the tyres at an adequate pressure saves fuel. If the tyre pressure is just one bar (14.5 psi/100 kPa) too low, fuel consumption can increase by as much as 5%. Due to the greater rolling resistance, under-inflation also increases tyre **wear** and impairs handling.

The tyre pressures should always be checked when the tyres are *cold*.

Do not use **winter tyres** all year round as they increase fuel consumption by up to 10%.

Avoid unnecessary weight

Given that every kilo of **extra weight** will increase the fuel consumption, it is advisable to always check the luggage compartment to make sure that no unnecessary loads are being transported.

A roof rack is often left in place for the sake of convenience, even when it is no longer needed. At a speed of 100 km/h (62 mph) and 120 km/h (75 mph) your vehicle will use about 12% more fuel as a result of the extra wind resistance caused by the roof rack even when it is not in use.

Save electricity

The engine activates the alternator, which produces electricity. With the need for electricity, fuel consumption also increases. Because of this, always turn off electrical devices when you do not need them. Examples of devices that use a lot of electricity are: the blower at high speeds, the rear window heating or the seat heaters*.

Note

- If your vehicle has *Start-Stop*, it is not recommended that you switch this function off.
- It is recommended that you *close the windows* when driving at more than 60 km/h (37 mph).
- Do not drive with your foot resting on the *clutch pedal*, as the pressure can make the plate spin, more fuel will be used and it can burn the clutch plate lining, causing a serious fault.
- Do not hold the car on a hill with the clutch, use the foot brake or hand brake, using the latter to start. The fuel consumption will be



lower and you will prevent the clutch plate from being damaged.

- On descents, use the engine brake, changing to the gear that is more suitable for the slope. Fuel consumption will be “zero” and the brakes will not suffer.



Engine management and emission control system

Introduction

WARNING



- Because of the high temperatures which can occur in the exhaust purification system (catalytic converter or diesel particulate filter), do not park the vehicle where the exhaust can come into contact with flammable materials under the car (e.g. on grass or at the forest edge). Fire hazard!
- Do not apply wax underneath the vehicle around the area of the exhaust system: Fire hazard!

Note

While the control lamps , , EPC or  or remain lit, there may be engine problems, fuel consumption may increase and the engine may lose power.

Catalytic converter

To maintain the useful life of the catalytic converter

- Use only unleaded petrol with petrol engines, as lead damages the catalytic converter.
- Do not let the fuel get too low in the tank.
- For engine oil changes, do not replenish with too much engine oil  page 268, Topping up engine oil.
- Never tow the vehicle to start it, use jump leads if necessary  page 71.

If you notice misfiring, uneven running or loss of power when the vehicle is moving, reduce speed immediately and have the vehicle inspected at the nearest specialised workshop. In general, the exhaust warning lamp will light up when any of the described symptoms occur  page 122. If this happens, unburnt fuel can enter the exhaust system and escape into the environment. The catalytic converter can also be damaged by overheating.

CAUTION

Never run the fuel tank completely dry because the irregularity of the fuel supply may cause ignition problems. This allows unburnt fuel to enter the exhaust system, which could cause overheating and damage the catalytic converter.

For the sake of the environment

Even when the emission control system is working perfectly, there may be a smell of sulphur from the exhaust gas under some conditions. This depends on the sulphur content of the fuel used. Quite often the problem can be solved by changing to another brand of fuel.

Diesel particulate filter

- ✓ Applies to vehicles with diesel engine

The diesel engine particulate filter eliminates most of the soot from the exhaust gas system. Under normal driving conditions, the filter cleans itself. The diesel particulate filter is cleaned automatically without need for indication by the warning lamp . This may be noticed because the engine idle speed increases and an odour may be detected.

If automatic filter purification cannot be carried out (because only short trips are taken, for example), soot will accumulate on the filter and the Diesel particulate filter warning lamp will  switch on.

Facilitate the automatic filter cleaning process by driving in the following manner: drive for approximately 15 minutes at a minimum speed of 60 km/h (37 mph) in 4th or 5th gear (automatic gearbox: gear S). Maintain the engine speed at approximately 2,000 rpm. The rise in temperature causes the soot on the

filter to burn. On completion of the cleaning the warning lamp will switch off. If the warning lamp does not switch off, go immediately to a specialised workshop to rectify the problem.

Engine management* EPC

This warning lamp monitors the engine management system for petrol engines.

The warning lamp **EPC** (Electronic Power Control) lights up when the ignition is switched on while system operation is being verified. It should go out once the engine is started.

If there is a fault in the electronic engine management system while you are driving, this warning lamp will light up. Take the vehicle to a specialised workshop as soon as possible and have the engine checked.

Emission control system*

Control lamp flashes:

When there is misfiring that can damage the catalytic converter. Reduce speed and drive carefully to the nearest specialised workshop to have the engine checked.

The control lamp lights up:

If a fault has developed during driving which has reduced the quality of the exhaust gas (e.g. lambda probe fault). Reduce speed and drive carefully to the nearest specialised workshop to have the engine checked.

Engine pre-heating/fault system*

The warning lamp lights up to show that the glow plugs are preheating the diesel engine.

The control lamp lights up

If the control lamp  lights up when the engine is started it means that the glow plugs are preheating. The engine can be started straight away when the lamp switches off.

Control lamp flashes

If a fault develops in the engine management system while you are driving, the glow plug system lamp will flash . Take the vehicle to a specialised workshop as soon as possible and have the engine checked.

Driving tips

Driving abroad

To drive abroad, the following must be taken into consideration:

- For vehicles fitted with a catalytic converter ensure that unleaded petrol is available for the journey. See chapter **»» page 258, Fuel**. Automobile organisations will have information about service station networks selling unleaded fuel.
- In some countries, it is possible that your car model is not sold, and therefore some spare parts are not available or the technical services may only be able to carry out limited repairs.

SEAT importers and distributors will gladly provide information about the technical preparation that your vehicle requires and also about necessary maintenance and repair possibilities.

Adhesive strips for headlights

In countries where vehicles drive on the other side of the road to your home country, the asymmetric dipped beam may dazzle drivers of oncoming vehicles. **»**

To prevent dazzling, you must apply stickers to certain parts of the headlight lenses. Further information is available at any Technical Service.

Driving on flooded roads

To prevent damage to the vehicle when driving through water, for example, along a flooded road, please observe the following:

- The water should never come above the lower edge of the bodywork.
- Drive at pedestrian speed.

⚠ WARNING

After driving through water, mud, sludge, etc., the braking effect can be delayed slightly due to moisture build-up on the discs and brake pads. Applying the brakes carefully several times will remove the moisture and restore the full braking effect.

ⓘ CAUTION

- Driving through flooded areas may severely damage vehicle components such as the engine, transmission, running gear or electrical system.
- Whenever driving through water, the Start-Stop system* must be switched off
»» page 204.

ⓘ Note

- Check the depth of the water before entering the flooded zone.
- Do not stop in the water, drive in reverse, or stop the engine in any situation.
- Note that vehicles travelling in the opposite direction may splash water that could exceed the maximum permitted water height for your vehicle.
- Avoid driving through salt water (corrosion).

Driver assistance systems

Start-Stop System*

Related video



BKJ-0097

Fig. 185 Convenience

Description and operation

The Start-Stop system helps save fuel and reduce CO₂ emissions.

In Start-Stop mode, the engine will automatically switch off when the vehicle stops or is stopping; for example when stopping at traffic lights. The ignition remains switched on during the stopping phase. The engine automatically switches back on when required. In

this situation, the light of the **START ENGINE STOP** button stays on¹⁾.

As soon as the ignition is switched on, the Start-Stop function is automatically activated.

Further information about the Start-Stop system can be found in the Easy Connect system: by pressing the **CAR** button in the **Vehicle status** menu.

Basic requirements for the Start-Stop mode

- The driver door must be closed.
- The driver must have their seat belt fastened.
- The bonnet must be closed.
- The engine must have reached a minimum service temperature.
- The reverse gear must not be engaged.
- The vehicle must not be on a very steep slope.

WARNING

• **Never switch the engine off until the vehicle is stationary. The brake servo and power steering functions will not be completely covered under warranty. More force may also be needed to turn the steering wheel or to brake. As you cannot steer and brake in the normal**

manner, there is a greater risk of accidents and serious injury.

- **Never remove the key from the ignition if the vehicle is in motion. Otherwise, the steering could lock making it impossible to steer the vehicle.**
- **To avoid injury, make sure that the Start-Stop system is switched off when working in the engine compartment »» page 207.**

CAUTION

The Start-Stop system must always be switched off when driving through flooded areas »» page 207.

Stopping/Starting the engine

Vehicles with a manual gearbox

- Before stopping the vehicle or when it is stopped, put it into neutral and release the clutch pedal. The engine will switch off. The warning lamp  will appear on the instrument panel display. The engine may stop before the vehicle comes to a halt in the deceleration phase (at 7 km/h).
- When the clutch pedal is pressed the engine will start up again. The warning lamp will switch off.

Vehicles with an automatic gearbox

- Use the foot brake to bring the vehicle to a stop and keep the brake pedal pressed down with your foot. The engine will switch off. The warning lamp  will appear in the display. The engine may stop before the vehicle comes to a halt in the deceleration phase (at 7 km/h or 2 km/h, depending on the vehicle's gearbox).
- When you take your foot off the brake pedal the engine will start up again. The warning lamp will switch off.

Additional information related to the automatic gearbox

The engine stops when the selector lever is in the positions P, D, N and S, in addition to when in manual mode. With the selector lever in position P, the engine will also remain switched off when you take your foot off the brake pedal. In order to start the engine up again the accelerator must be pressed, or another gear engaged or the brake released.

If the selector lever is placed in position R during the stopping phase, the engine will start up again.

Change from position D to P to prevent the engine from accidentally starting when changing and passing by position R.

¹⁾ Only in vehicles with Keyless Access.

Additional information about vehicles with Adaptive Cruise Control (ACC)

In vehicles with ACC function, the engine will start up again in certain operating conditions if the radar sensor detects that the vehicle ahead drives off again.

Note

- In vehicles with an automatic gearbox, you can control whether the engine should switch off or not by reducing or increasing the brake force applied. While the vehicle remains stopped, the engine will not stop if the brake pedal is slightly pressed, in traffic jams with frequent stopping and starting for example. As soon as strong pressure is applied to the brake pedal, the engine will stop.
- In vehicles with manual gearbox, during the stopping phases the brake pedal must remain depressed to prevent the vehicle from moving.
- If the engine “stalls” in vehicles with manual gearbox, it can be directly started up again by immediately pressing the clutch pedal.



General notes

The system can interrupt the Start-Stop mode frequently for different reasons.

The engine does not switch off

Before the stopping phase, the system verifies whether certain conditions are met. The engine **does not** switch off, in the following situations for example:

- The engine has not yet reached the minimum required temperature for the Start-Stop mode.
- The interior temperature selected for the air conditioner has not yet been reached.
- The interior temperature is very high/low.
- Defrost function button activated
»  page 51.
- The parking aid* is switched on.
- The battery is very low.
- The steering wheel is overly turned or is being turned.
- If there is a danger of misting.
- After engaging reverse gear.
- In case of a very steep gradient.

The indication  is shown on the instrument panel display, and in addition, the driver information system* shows, START  STOP.

The engine starts by itself

During a stopping phase the normal Start-Stop mode can be interrupted in the following situations: The engine restarts by itself without involvement from the driver.

- The interior temperature differs from the value selected on the air conditioner.
- Defrost function button activated
»  page 51.
- The brake has been pressed several times consecutively.
- The battery is too low.
- High power consumption.

Note

In vehicles with an automatic gearbox, if the selector lever is placed in position D, N or S after engaging reverse gear, the vehicle must be driven at a speed faster than 10 km/h (6 mph) for the system to return to conditions in which the engine can be stopped.

Manually switching on/off the Start-Stop system



Fig. 186 Centre console: Start-Stop system button.

If you do not wish to use the system, you can switch it off manually.

- To manually switch on/off the Start-Stop system, press the button »» **Fig. 186**.

The symbol on the button remains lit up yellow when the system is switched off, and the following message is displayed on the dash panel:

Start-Stop system deactivated

Note

The system is automatically switched on each time the engine is deliberately stopped during a stopping phase. The engine will start automatically.

Driver messages on the instrument panel display

Start-Stop system deactivated. Start the engine manually

This driver message is displayed when certain conditions are not met during the stopping phase and the Start-Stop system **cannot** restart the engine. The engine must be started manually.

Start-Stop system: Fault! Function not available

There is a fault in the Start-Stop system. Take the vehicle to a workshop to have the fault repaired.

Cruise control system (CCS)*

How it works



Fig. 187 Instrument panel display: CCS status indications.

Read the additional information carefully »» page 45

The cruise control system (CCS) is able to maintain the set speed from 20 km/h (15 mph).

The CSS only reduces vehicle speed by ceasing to accelerate, not by actively braking the vehicle »» .

Control lamp



Lights up

The Cruise Control System (GRA) is switched on and active.

OR: The Adaptive Cruise Control system (CCS) is switched on and active.

OR: the speed limiter is switched on and active.

Several warning and control lamps light up for a few seconds when the ignition is switched on, signalling that the function is being verified. They will switch off after a few seconds.

Displayed on the CCS screen

Status Fig. 187:

- A** CCS temporarily switched off. The set speed is displayed in small or darkened figures.
- B** System error. Contact a specialised workshop.
- C** CCS switched on. The speed memory is empty.
- D** The CCS is switched on. The set speed is displayed in large figures.

WARNING

Use of the cruise control could cause accidents and severe injuries if it is not possible

to drive at a constant speed maintaining the safety distance.

- Do not use the cruise control in heavy traffic, if the distance from the vehicle in front is insufficient, on steep roads, with several bends or in slippery circumstances (snow, ice, rain or loose gravel), or on flooded roads.
- Never use the CCS when driving off-road or on unpaved roads.
- Always adapt your speed and the distance to the vehicles ahead in line with visibility, weather conditions, the condition of the road and the traffic situation.
- To avoid unexpected operation of the cruise control system, turn it off every time you finish using it.
- It is dangerous to use a set speed which is too high for the prevailing road, traffic or weather conditions.
- When travelling down hills, the CCS cannot maintain a constant speed. The vehicle tends to accelerate under its own weight. Select a lower gear or use the foot brake to slow the vehicle.

WARNING

Observe the safety warnings » in Warning symbols on page 122.

Operating the cruise control system*

Read the additional information carefully » page 45

The value indicated in the table in brackets (in mph, miles per hour) only refers to instrument panels with indications in miles.

Changing gear in CCS mode

The CCS decelerates as soon as the clutch pedal is pressed, intervening again automatically after a gear is engaged.

Travelling down hills with the CCS

When travelling down hills the CCS cannot maintain a constant speed. Slow the vehicle down using the brake pedal and reduce gears if required.

Automatic off

The cruise control system (CCS) is switched off automatically or temporarily:

- If the system detects a fault that could affect the working order of the CCS.
- If you press and maintain the accelerator pedal for a certain time, driving faster than the stored speed.
- If the dynamic driving control systems intervene (e.g. ASR or ESC).
- If the brake pedal is pressed.
- If the airbag is triggered.

- If the gear lever of the DSG® dual clutch gearbox is removed from the **D/S** position.

⚠ WARNING

After use, always switch off the speed limiter to prevent the speed being regulated against your wishes.

- The speed limiter does not relieve the driver of their responsibility to drive at the appropriate speed. Do not drive at high speed if not necessary.

- Using the speed limiter with adverse weather conditions is dangerous and can cause serious accidents, e.g. because of aquaplaning, snow, ice, leaves, etc. You should use the speed limiter function only when traffic, road and weather conditions allow it to be used safely.

- When driving downhill, the speed limiter cannot limit the vehicle speed. Its speed will increase due to its own weight. In this case, select a lower gear or use the foot brake to slow the vehicle.

Speed limiter

Display messages and warning and control lamp



Fig. 188 On the instrument panel display: messages on the status of the speed limiter.

The speed limiter helps avoid exceeding a speed individually programmed upwards of approximately 30 km/h (19 mph) driving in forwards gears »» ⚠

Display messages on the speed limiter

Status »» **Fig. 188:**

- (A)** The speed limiter is active. The last speed set is displayed in large figures.
- (B)** The speed limiter is not active. The last speed set is displayed in small or darkened figures.
- (C)** The speed limiter is switched off. The total mileage is displayed.

Warning and control lamp

⚠ Lights up green

The speed limiter is switched on and active.

⚠ Flashes green

The speed set by the speed limiter has been exceeded.

⚠ Lights up

The adaptive cruise control (ACC) and the speed limiter are active.

Some warning and control lamps will light up briefly when the ignition is switched on to check certain functions. They will switch off after a few seconds.

⚠ WARNING

After use, always switch off the speed limiter to prevent the speed being regulated against your wishes.

- The speed limiter does not relieve the driver of their responsibility to drive at the appropriate speed. Do not drive at high speed if not necessary.
- Using the speed limiter with adverse weather conditions is dangerous and can cause serious accidents, e.g. because of aquaplaning, snow, ice, leaves, etc. You should use the speed limiter function only when traffic, road and weather conditions allow it to be used safely.

- When driving downhill, the speed limiter cannot limit the vehicle speed. Its speed will increase due to its own weight. In this case, select a lower gear or use the foot brake to slow the vehicle.

⚠ WARNING

Observe the safety warnings » **⚠** in Warning symbols on page 122.

i Note

- Different versions of the instrument panel are available and therefore the versions and instructions on the display may vary.
- If when switching the ignition off, the cruise control system (CCS), the adaptive cruise control (ACC) or the speed limiter were switched on, then the cruise control system

or the adaptive cruise control will automatically switch themselves on when the ignition is back on. However, no speed will be stored. The last set speed of the speed limiter will be stored.

Operate the speed limiter

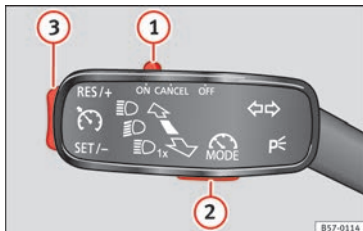

Fig. 189 On the left of the steering column: control and buttons to operate the speed limiter.

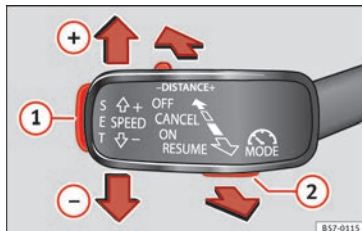

Fig. 190 On the left of the steering column: third lever for operating the speed limiter.

Function	Position of the turn signal lever » Fig. 189 or the third lever » Fig. 190	Effect
Switching on the speed limiter	Move controller (1) to position ON and press button (2) of the turn signal lever or move the third lever forward and press button (2) .	The system switches on. The last set speed of the speed limiter is stored. It does not take effect yet.

Driver assistance systems

Function	Position of the turn signal lever » Fig. 189 or the third lever » Fig. 190	Effect
Switching between the speed limiter and cruise control (CCS) or the adaptive cruise control (ACC) (with the speed limiter switched on)	Press button ② on the turn signal lever or button ② on the third lever	It switches between the speed limiter and the CCS or the adaptive cruise control (ACC).
Activating the speed limiter	Press button ③ on the turn signal lever or button SET ① on the third lever.	The current speed is stored as the maximum speed and the limiter is switched on.
Temporarily switching off the speed limiter limitation	Place control ① of the turn signal lever in position CANCEL or move the third lever into position CANCEL.	The limiter is switched off temporarily. The speed will be stored.
Temporarily switch off the speed limiter limitation pressing down the accelerator (kick-down)	Press down on the accelerator beyond the point of resistance (e.g. to overtake). Surpassing the set speed switches the speed limiter off temporarily.	The limiter is switched off temporarily. The speed will be stored. The limiter is reactivated automatically after returning to less than the set speed.
Switching the speed limiter on again	Press button ③ on the turn signal lever or move the third lever into position RESUME.	The speed is limited to the set speed as soon as the speed you are driving at is lower than the speed set as maximum.
Increasing the set speed of the limiter	Briefly press button ③ on the turn signal lever in the RES/+ area or move the third lever into position RESUME to increase the speed in small increments of 1 km/h (1 mph) and set it.	The speed is limited to the set value
	Press SPEED+ on the third lever to increase the speed in increments of 10 km/h (5 mph) and set it. Hold down button ③ on the turn signal lever in the area RES/+ or hold down SPEED+ to increase continuously in increments of 10 km/h (5 mph) and set it.	
Reducing the set speed of the limiter	Briefly press button ③ on the turn signal lever in the SET/- area or press SET ① on the third lever to reduce the speed in small increments of 1 km/h (1 mph) and set it.	The speed is limited to the set value
	Press SPEED- on the third lever to reduce the speed in increments of 10 km/h (5 mph) and set it. Hold down button ③ on the turn signal lever in the SET/- area or hold down SPEED- to reduce the speed continuously in increments of 10 km/h (5 mph) and set it.	



Function	Position of the turn signal lever » Fig. 189 or the third lever » Fig. 190	Effect
Switching off the speed limiter	Move control ① of the turn signal lever into position OFF or the third lever into position OFF .	The system switches off

The values shown in the table in brackets, in mph, are displayed only in instrument panels with indications in miles.

Going down slopes with the speed limiter

If the set speed of the speed limiter is exceeded while driving downhill, soon afterwards the warning and control lamps ☹️ » page 209 flash and an acoustic warning may sound. In this case, use the foot brake to slow the vehicle or, if necessary, select a lower gear.

Switching off temporarily

If you wish to temporarily switch off the speed limiter, e.g. to overtake, move control » Fig. 189 ① of the turn signal lever into position **CANCEL** or the third lever into pressure point **CANCEL** or press button ② on any lever.

After overtaking, the speed limiter can be switched on with the previously set speed by pressing button ③ on the turn signal lever in the area **RES/+** or by moving the third lever into pressure point **RESUME**.

Switch the speed limiter off temporarily by pressing down the accelerator (kick-down)

If the accelerator is pressed right down (kick-down) and the set speed is exceeded because driver wishes to do so, the limiter is temporarily disabled.

To confirm it being switched off an acoustic signal sound once. While the limiter is off, the warning and control lamp ☹️ flashes.

When the accelerator is no longer pressed down and the speed is reduced below the set value, the limiter switches on again. The control lamp ☹️ will light up and remain lit.

Automatic off

The speed limiter is automatically switched off:

- If the system detects a fault that could negatively affect the working order of the limiter.
- If the airbag is triggered.

⚠️ CAUTION

For automatic switching off due to system failures, for security reasons, the limiter is only completely switched off when the driver

stops pressing the accelerator at some point or consciously switches off the system.

Emergency brake assist system (Front Assist)*

Topic introduction



Fig. 191 On the instrument panel display: pre-warning messages.

The objective of the emergency brake assist system is to prevent head-on collisions against objects that may be in the vehicle's path or minimise the consequences of such impacts.

Within the limitations imposed by the environmental conditions and by the system itself, the function acts in staggered fashion, depending on how critical the situation is. Initially it warns the driver, and if the driver's reaction does not occur or is insufficient, it activates an independent emergency braking.

The function is intended to prevent collisions with parked vehicles or vehicles in the same lane travelling in the same direction, or with pedestrians crossing the vehicle's path. It may fail to activate in other danger situations.

The Front Assist function is active within a range of speeds between 4 km/h (2.5 mph) and 250 km/h (156 mph). Depending on speed, traffic conditions and driver behaviour, some of the sub-functions described below are omitted in order to optimise the system's general behaviour.

The Front Assist is a driving assistance function that can never replace the driver's attention.

Safety distance warning

If the system detects a situation of danger because the vehicle is too close to the vehicle ahead, it will warn the driver by means of an indication on the instrument panel display



The timing of the warning varies depending on driver behaviour and the traffic situation.

Advance warning

If the system detects a possible collision with the vehicle in front, it may alert the driver by means of an audible warning and an indication on the instrument panel display

»» Fig. 191.

The warning moment varies depending on the traffic situation and driver behaviour. At the same time, the vehicle will prepare for a possible emergency braking »» .

Critical warning

If the driver fails to react to the pre-warning (advance warning), the system may actively intervene in the brakes and generate a brief jolt to warn the driver of the imminent danger of a collision.

Automatic braking

If the driver also fails to react to the critical warning, the system may initiate independent emergency braking by progressively increasing the braking effect in accordance with how critical the situation is.

Driver emergency brake assist system

Faced with an imminent collision, the system may detect that the driver is not braking hard

enough to avoid the collision. In this case, it will automatically increase the braking effect.

Due to certain driving circumstances and the limitations of its operation, there are some cases in which the system cannot prevent a collision, although it can significantly minimise the consequences by reducing the speed and the force of the impact.

WARNING

Observe the safety warnings »»  in Warning symbols on page 122.

WARNING

The Front Assist system cannot change the laws of physics or replace the driver in terms of keeping control of the vehicle and reacting to a possible emergency situation.

WARNING

Following a Front Assist emergency warning, pay immediate attention to the situation and try to avoid the collision by braking or by dodging the obstacle, as applicable.

- If the Front Assist does not work as described in this chapter (e.g. it repeatedly intervenes unnecessarily), switch it off.
- Adapt your speed and safe distance to the vehicle in front of you at all times to suit visibility, weather, road and traffic conditions.
- The Front Assist alone cannot avoid accidents and serious injuries.

»»

- In complex driving situations, occasionally the Front Assist may issue warnings and intervene in braking unnecessarily, for example at traffic islands.
- If the operation of the Front Assist is impaired, for example, by dirt or because the radar sensor has lost its settings, the system may issue unnecessary warnings and intervene inopportunely in the braking.
- The Front Assist does not react to animals or vehicles crossing your path or approaching head-on down the same lane.
- The Front Assist does not react to pedestrians walking in the same direction or approaching head-on down the same lane.
- The driver must always be ready to take over the control of the vehicle.
- When the Front Assist causes a braking, the brake pedal is “harder”.
- Automatic interventions by the Front Assist on the brakes may be interrupted by pressing the clutch, accelerator or moving the wheel.

Note

- When the Front Assist is connected, the indications on the instrument panel screen may be concealed by warnings from other functions, such as an incoming call.
- When the Front Assist causes a braking, the brake pedal is “harder”.

- Automatic interventions by the Front Assist on the brakes may be interrupted by pressing the clutch, accelerator or moving the wheel.
- The Front Assist may brake the vehicle until it stops completely. However, the brake system does not halt the vehicle permanently. Use the foot brake!
- If the Front Assist does not work as described in this chapter (e.g. in intervenes several times unnecessarily), switch it off. Have the system checked by a specialised workshop. SEAT recommends visiting a SEAT dealership.

Radar sensor



Fig. 192 On the front bumper: radar sensor.

A radar sensor is installed on the front bumper to determine the traffic situation
 » Fig. 192 ①.

The radar sensor's visibility may be impaired by dirt, mud or snow, or by environmental in-

fluences such as rain or mist. In this case, the Front Assist does not work. The instrument panel displays the following message:
Front Assist: No sensor vision! If necessary clean the radar sensor » ①.

When the radar sensor begins to operate properly again, the Front Assist will automatically be available again. The message will disappear from the instrument panel display.

Front Assist operation may be affected by a strong radar reverse reflection. This may occur, for example, in a closed car park or due to the presence of metallic objects (e.g. rails on the road or sheets used in road works).

The area in front of and around the radar sensor should not be covered with adhesives, additional or similar headlights, as this may negatively affect Front Assist operation.

If the front of the vehicle is not properly repaired or structural modifications are made to it, for example if the suspension is lowered, Front Assist operation may be affected. SEAT recommends visiting a SEAT dealership for this purpose.

ⓘ CAUTION

If you have the sensation that the radar sensor is damaged or has lost its settings, disconnect the Front Assist. This will avoid possible dangerous situations caused by a system malfunction. If this occurs have it adjusted.

- The sensor may become damaged or lose its settings when knocked, for example, during a parking manoeuvre. This may compromise the system's efficacy or disconnect it.
- Repairs to the radar sensor require specialist knowledge and special tools. SEAT recommends visiting a SEAT dealership for this purpose.
- A registration plate or plate holder on the front that is larger than the space for the registration plate, or a registration plate that is curved or warped can cause the radar to malfunction.
- Clean away the snow with a brush and the ice preferably with a solvent-free de-icer spray.

Operating the Emergency braking assistance system (Front Assist)



Fig. 193 On the instrument panel display: Front Assist switched off message.

The Front Assist is active whenever the ignition is switched on.

When the Front Assist is switched off, so too are the advance warning function (pre warning) and the distance warning.

SEAT recommends leaving the Front Assist always switched on. Exceptions » page 216, **Switching the Front Assist off temporarily in the following situations.**

Switching the Front Assist on and off

With the ignition switched on, the Front Assist can be switched on and off as follows:

- Select the corresponding menu option using the button for the driver assistance systems » page 37.
- **OR:** switch the system on and off in Easy Connect using the **(CAR)** button and the **(SETTINGS)** and **(Driver assistance)** function buttons » page 34.

When Front Assist is switched off, the instrument panel will inform that it has been switched off with the following indicator » **Fig. 193.**

Activating or deactivating the pre-warning (advance warning)

The pre-warning function (advance warning) can be switched on or off in the Easy Connect system with the **(CAR)** button and the **(SETTINGS)**

and **(Driver assistance)** function buttons » page 34.

The system will store the setting for the next time the ignition is switched on.

SEAT recommends keeping the pre-warning function switched on at all times.

Depending on the infotainment system installed in the vehicle, the advance warning function may be adjusted as follows:

- Advance
- Medium
- Delayed
- Deactivated

SEAT recommends driving with the function in “Medium” mode.

Switching distance warning on and off

If the safe distance with regard to the vehicle in front is exceeded, the relevant warning will appear on the instrument panel display . In this case, increase the safe distance.

The distance warning can be switched on and off in the Easy Connect system using the **(CAR)** button and the **(SETTINGS)** and **(Driver assistance)** function buttons » page 34.

The system will store the setting for the next time the ignition is switched on. »

SEAT recommends keeping the distance warning switched on at all times.

Switching the Front Assist off temporarily in the following situations

In the following situations the Front Assist should be deactivated due to the system's limitations:

- When the vehicle is to be towed.
- If the vehicle is on a test bed.
- When the radar sensor is damaged.
- If the radar sensor takes a heavy knock, for example in a rear collision.
- If it intervenes several times unnecessarily.
- If the radar sensor is covered temporarily with some kind of accessory, such as an additional headlight or the like.
- When the vehicle is to be loaded on a lorry, ferry or train.

System limitations

The Front Assist has certain physical limitations inherent to the system. Thus, in certain circumstances, some of the system's reactions may be inopportune from the driver's standpoint. So pay attention in order to intervene if necessary.

The following conditions may cause the Front Assist not to react or to do so too late:

- In the first few instants of driving after switching on the ignition, due to the system's initial auto-calibration.
- On taking tight bends or complex paths.
- Pressing the accelerator all the way down.
- If the Front Assist is switched off or damaged.
- If the ASR has been disconnected or the ESC activated in **Sport** mode manually » page 185.
- If the ESC is controlling.
- If several brake lights of the vehicle or electrically connected trailer are damaged.
- If the radar sensor is dirty or covered.
- If there are metal objects, e.g. rails on the road or sheets used in road works.
- If the vehicle is reversing.
- If the vehicle over-accelerates.
- In case of snow or heavy rain.
- In case of narrow vehicles, such as motor-bikes.
- Misaligned vehicles.
- Vehicles crossing the other's path.
- Vehicles approaching in the opposite direction.

- Special loads and accessories of other vehicles that jut out over the sides, backwards or over the top.

Adaptive Cruise Control (ACC)*

Related video



Topic introduction

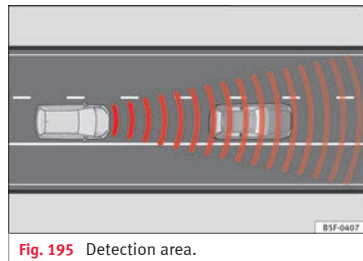



Fig. 195 Detection area.

The adaptive cruise control (ACC) **is an extension of the normal cruise control system (CCS)** » » .

The ACC function allows the driver to program a cruise speed of between 30 and 210 km/h (18 and 150 mph) and to select the distance required with regard to the vehicle in front.

The ACC will adapt the vehicle's cruise speed at all times, maintaining a safe distance with the vehicle in front based on its speed.

When driving behind another vehicle, the ACC function reduces speed until it is the same as that of the vehicle ahead and maintains the set distance between the vehicles. If the vehicle ahead accelerates, the adaptive cruise control also accelerates, going no higher than the target speed programmed.

If the vehicle is equipped with automatic gearbox, the ACC can brake the vehicle **until it stops completely** if a vehicle in front of it stops.

The distance programmed should be increased when the road surface is wet.

Driver intervention prompt

During driving, the ACC is subject to certain limitations inherent in the system. In other words, in certain circumstances the driver will have to adjust speed him or herself, as well as the distance from other vehicles.

In this case, the instrument panel screen *will warn you to intervene* by applying the brake and a warning tone will be heard » » page 218.

WARNING

The intelligent technology in the ACC cannot overcome the system's inherent limitations or change the laws of physics. If used negligently or involuntarily, it may cause serious accidents and injuries. The system is not a replacement for driver awareness.

- Adapt your speed and safe distance to the vehicle in front of you at all times to suit visibility, weather, road and traffic conditions.
- Do not use the ACC when visibility is bad, on steep roads, with several bends or in slippery circumstances such as snow, ice, rain or loose gravel, or on flooded roads.
- Never use the ACC when driving off-road or on unpaved roads. The ACC has been designed for use on paved roads only.
- The ACC does not react on approaching a fixed obstacle, such as the tail of a traffic jam, a damaged vehicle or a vehicle stopped at the traffic lights.
- The ACC only reacts to people if a pedestrian monitoring system is available. In addition, the system does not react to animals or vehicles crossing your path or approaching head-on down the same lane.
- If the ACC does not reduce speed sufficiently, brake the vehicle immediately by applying the pedal.

- If you are driving using the spare wheel, the ACC function could automatically switch off during your journey. Switch off the system when starting off.
- If the vehicle continues to move involuntarily after a driver intervention prompt, brake the vehicle by applying the pedal.
- If the dash panel displays a *driver intervention prompt*, adjust the distance yourself.
- The driver should be ready to accelerate or brake by him/herself at all times.

CAUTION

If you have the sensation that the radar sensor is damaged, disconnect the ACC. This will avoid possible damage. If this occurs have it adjusted.

- Repairs to the radar sensor require specialist knowledge and special tools. SEAT recommends visiting a SEAT dealership for this purpose.

Note

- If the ACC system does not work as described in this chapter, do not use it until it has been checked by a specialised workshop. SEAT recommends visiting a SEAT dealership for this purpose.
- Maximum speed with the ACC activated is limited to 210 km/h (150 mph).

»

- When the ACC is switched on, strange noises may be heard during automatic braking caused by the braking system.

Indications on the display, warning and control lamps

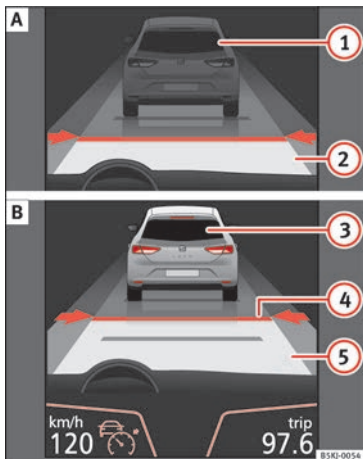

Fig. 196 On the instrument panel display: (A) ACC inactive (Standby). (B) ACC active.

Status display

Indications on the display » **Fig. 196:**

- ① Vehicle ahead detected. ACC is not active and is not regulating your speed.
- ② Distance from the vehicle ahead. ACC is not active and is not regulating your distance.
- ③ Vehicle ahead detected. ACC is active and is regulating your speed.
- ④ Distance level 2 set by the driver.
- ⑤ ACC is active and is regulating your distance based on speed.

Symbols on the instrument panel display and control lamps.

» **⚠** in Warning symbols on page 122.



The speed reduction by the ACC to maintain the distance from the vehicle in front is not sufficient.

Brake! apply the foot brake! Driver intervention prompt.



The ACC is not currently available.^{a)}

With the vehicle stationary, switch off the engine and start it up again. Check the radar sensor visually » **Fig. 197** (for dirt, ice or knocks). If it is still unavailable, refer to a specialised workshop to have the system inspected.

^{a)} The symbol on the instrument panels with colour display is in colour.



The ACC is active.

No vehicle is detected in front. The programmed speed remains constant.



If the symbol is white: the ACC is active.

A vehicle in front has been detected. The ACC adjusts speed and distance from the vehicle in front.



If the symbol is grey: ACC is inactive (Standby)

The system is switched on, but is not adjusting.



It lights up green:

The ACC is active.

Some warning and control lamps will light up briefly when the ignition is switched on to check certain functions. They will switch off after a few seconds.

⚠ WARNING

Observe the safety warnings » **⚠ in Warning symbols on page 122.**



Note

When the ACC is connected, the indications on the instrument panel screen may be concealed by warnings from other functions, such as an incoming call.

Radar sensor



Fig. 197 On the front bumper: radar sensor.

A radar sensor is installed on the front bumper to determine the traffic situation

»» Fig. 197 ①.

The radar sensor's visibility may be impaired by dirt, mud or snow, or by environmental influences such as rain or mist. In this case the adaptive cruise control (ACC) does not work. The instrument panel displays the following message: **ACC: No sensor vision!** If necessary clean the radar sensor »» ①.

When the radar sensor begins to operate properly again, the ACC will automatically be available again. The message on the instrument panel screen will switch off and the ACC will be reactivated again.

ACC operation may be affected by a strong radar reverse reflection. This may occur, for example, in a closed car park or due to the

presence of metallic objects (e.g. rails on the road or sheets used in road works).

The area in front of and around the radar sensor should not be covered with adhesives, additional or similar headlights, as this may negatively affect ACC operation.

If the front of the vehicle is not properly repaired or structural modifications are made to it, for example, if the suspension is lowered, ACC operation may be affected. In this scenario, SEAT recommends visiting a SEAT dealership.

ⓘ CAUTION

If you have the sensation that the radar sensor is damaged or has lost its settings, disconnect the ACC. This will avoid possible damage. If this occurs have it adjusted.

- The sensor may become damaged or lose its settings when knocked, for example, during a parking manoeuvre. This may compromise the system's efficacy or disconnect it.
- Repairs to the radar sensor require specialist knowledge and special tools. SEAT recommends visiting a SEAT dealership for this purpose.
- Clean away the snow with a brush and the ice preferably with a solvent-free de-icer spray.

Operating the Adaptive Cruise Control (ACC)

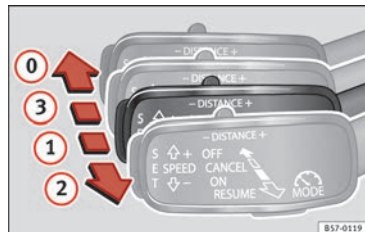

Fig. 198 On the left of the steering column: third lever for operating the Adaptive Cruise Control.

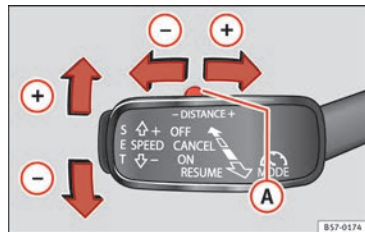

Fig. 199 On the left of the steering column: third lever for operating the Adaptive Cruise Control.

When the Adaptive Cruise Control (ACC) is connected, the green control lamp (🟢) will light up on the instrument panel, and the

programmed speed and ACC status will be displayed » **Fig. 196.**

What ACC settings are possible?

- Setting your speed » **page 220.**
- Setting your distance » **page 220.**
- Connecting and activating the ACC » **page 220.**
- Disconnecting and deactivating the ACC » **page 220.**
- Adjusting the default distance level at the start of your journey » **page 220.**
- Adjusting the driving profile » **page 221.**
- Conditions in which the ACC does not react » **page 221.**

Setting speed

To set your speed, move the third lever located in position ① upwards or downwards until the desired speed is shown on the instrument panel display. The speed adjustment is made at 10 km/h (6 mph) intervals.

Once you are driving, if you wish to set the current speed as the vehicle's cruise speed and activate the ACC, press the **SET** button » **Fig. 199.** If you wish to increase or reduce speed by intervals of 1 km/h (0.6 mph), move the lever to position ② » **Fig. 198** or press the **SET** button, respectively.

The set speed can be changed when the vehicle is stopped or during driving, as you like.

Any modification to the programmed speed will be shown on the bottom left part of the instrument panel display » **Fig. 196.**

Setting your distance level

To increase/reduce the distance level, press the rocker switch towards the left/right » **Fig. 199** ①.

The instrument panel display shows the modification of the distance level. There are 5 distance levels to choose from. SEAT recommends level 3. The set distance can be changed when the vehicle is stopped or during driving, as you like » **△.**

Connecting and activating the ACC

To connect and activate the ACC, the position of the gearbox selector lever, the vehicle speed and the position of the third level of the ACC must all be taken into account.

- With a manual gearbox, the gearbox selector lever must be in any gear except first, and speed must be greater than approximately 30 km/h. With an automatic gearbox, the gearbox selector lever must be in position **D** or **S**.
- To activate the ACC, with the third lever in position ① press the **SET** button or move the third lever of the ACC to position ② » **Fig. 198.** At this point, the image of the ACC on the instrument panel display will switch to *Active* mode » **Fig. 196.**

When the ACC function is active, the vehicle travels at a set speed and distance from the vehicle ahead. Both speed and distance can be changed at any time.

Disconnecting and deactivating the ACC

To disconnect the ACC move the lever to the ① position » **Fig. 198** (engaged). An **ACC deactivated** message appears and the function is totally deactivated.

If you do not wish to disconnect the ACC, just to switch it temporarily to inactive mode (Standby), move the third lever to position ③ » **Fig. 198** or press the brake pedal.

It will also switch to inactive mode (Standby) if the vehicle is stopped and the driver door is opened.

Adjusting the default distance level at the start of your journey.

In wet road conditions, you should always set a larger distance with regard to the vehicle in front than when driving in dry conditions.

The following distances can be preselected:

- Very short
- Short
- Media
- Long
- Very long

In the Easy Connect system you can adjust the distance level that will be applied when the ACC is connected using the **CAR** button and the **SETTINGS** and **Driver assistance** function buttons »  page 34.

Changing the driving profile

In vehicles with SEAT Drive Profile, the driving profile selected can have an influence on the ACC's acceleration and braking behaviour » **page 225**.

In vehicles without SEAT Drive Profile, the behaviour of the ACC can also be affected by selecting any of the following drive profiles in the Easy Connect system:

- Normal
- Sport
- Eco
- Convenience

In this case, you should access the ACC settings using the **CAR** button and the **SETTINGS** > **Driver assistance** > **ACC** function buttons »  page 34.

The following conditions may lead the ACC not to react:

- If the accelerator is pressed.
- If there is no gear engaged.
- If the ESC is controlling.

- If the driver is not wearing his/her seat belt.
- If several brake lights of the vehicle or electrically connected trailer are damaged.
- If the vehicle is reversing.
- Driving faster than 210 km/h (150 mph).

Driver messages

ACC not available

The system can no longer continue to guarantee safe vehicle detection and will be deactivated. The sensor has lost its setting or is damaged. Take the vehicle to a specialised workshop and have the fault repaired.

ACC and Front Assist: currently not available. No sensor vision

This message will be displayed to the driver if the radar sensor's vision is impaired due, for example, to leaves, snow, heavy fog or dirt. Clean the sensor » **Fig. 197**.

ACC: currently not available. Gradient too steep

The maximum road slope has been exceeded, hence safe ACC operation cannot be guaranteed. The ACC cannot be switched on.

ACC: only available in D, S or M

Select the D/S or M position on the selector lever.

ACC: parking brake applied

The ACC is deactivated if the parking brake is applied. The ACC is available once again after the parking brake is released.

ACC: currently not available. Intervention of stability control

The message for the driver is displayed when the electronic stability control (ESC) intervenes. In this case, the ACC is automatically switched off.

ACC: Take action!

The message for the driver is displayed if, when the vehicle starts up on a hill with a mild slope, the vehicle rolls back even although the ACC is activated. Apply the brake to stop the vehicle from moving/colliding with another vehicle.

ACC: speed limit

The message for the driver is displayed if, in vehicles with manual gearbox, the current speed is too low for the ACC mode.

The speed to be stored must be at least 30 km/h (18 mph). The speed limiter switches off if the speed falls below 20 km/h (12 mph).

ACC: available as of the 2nd gear »

The ACC is operational as of the 2nd gear (manual gearbox).

ACC: engine speed

The message for the driver is displayed if, when the ACC accelerates or brakes, the driver does not shift up or down a gear in time, which means exceeding or not reaching the permissible engine speed. The ACC switches itself off. A buzzer warning is heard.

ACC: clutch pressed

Vehicles with a manual gearbox: pressing the clutch pedal for longer abandons control mode.

Door open

Vehicles with automatic gearbox: the ACC cannot be activated with the vehicle stationary and the door open.

WARNING

There is a danger of rear collision when the minimum distance to the vehicle in front is exceeded and the speed difference between both vehicles is so great that a speed reduction by the ACC will not suffice. In this case the brake pedal should be applied immediately.

- The ACC may not be able to detect all situations properly.
- “Stepping” on the accelerator may cause the ACC not to intervene in braking. Driver

braking will have priority over intervention by the speed control or adaptive cruise control.

- Always be ready to use the brakes!
- Observe country-specific provisions governing obligatory minimum distances between vehicles.
- It is dangerous to activate control and resume the programmed speed if the road, traffic or weather conditions do not permit this. Risk of accident!

Note

- The programmed speed is erased once the ignition or the ACC are switched off.
- When the traction control system (ASR) is deactivated during acceleration or else the ESC is activated in Sport* Mode (» page 123), the ACC switches off automatically.
- In vehicles with the Start-Stop system, the engine switches off automatically during the ACC stopping phase and restarts automatically to begin driving.

Function for preventing overtaking in an inside lane



Fig. 200 On the instrument panel display: ACC active, vehicle detected in an outer lane.

The adaptive cruise control (ACC) has a function that helps avoid overtaking while driving in inside lanes at certain speeds.

If another vehicle is detected travelling at a slower speed in an outer lane, it is displayed on the multifunction display » **Fig. 200**.

To avoid overtaking while driving in an inside lane the system will gently brake, and in accordance with the speed will prevent the car from overtaking. The driver can override this function at any time by pressing the accelerator pedal. At low speeds the function is inactive, for greater comfort in a traffic jam or in city traffic.

Deactivating the Adaptive Cruise Control ACC temporarily in certain situations

In the following situations the Adaptive Cruise Control (ACC) should be deactivated due to the system's limitations » :

- When changing lanes, on tight bends and roundabouts, in acceleration and deceleration lanes on motorways or in sections with road works to prevent involuntary acceleration to reach the programmed speed.
- When going through a tunnel, as operation could be affected.
- On roads with several lanes, when other vehicles are driving more slowly in the overtaking lane. In this case, slower vehicles will be overtaken on the right.
- In case of heavy rain, snow or spray, as the vehicle in front might not be detected properly or, in certain circumstances, might not be detected at all.

WARNING

If the ACC does not switch off in the situations described, serious accidents and injuries may occur.

- Always switch off the ACC in critical situations.

Note

If you do not switch off the ACC in the aforementioned situations, you may commit a legal offence.

Special driving situations

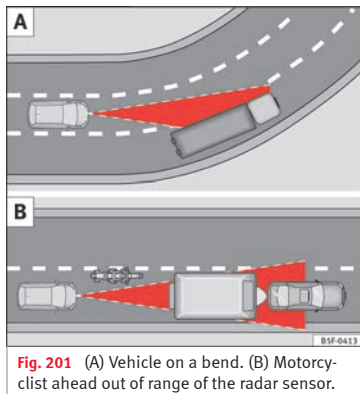

Fig. 201 (A) Vehicle on a bend. (B) Motorcyclist ahead out of range of the radar sensor.

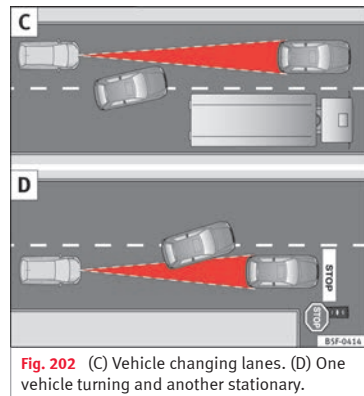



Fig. 202 (C) Vehicle changing lanes. (D) One vehicle turning and another stationary.

The adaptive cruise control (ACC) has certain physical limitations inherent in the system. For example, certain reactions of the ACC, in certain circumstances, may be unexpected or come late from the driver's point of view. So pay attention in order to intervene if necessary.

For example, the following traffic situations call for the utmost attention:

Starting driving after a stopping phase (only vehicles with automatic gearbox)

After a stopping phase, the ACC may begin driving automatically when the vehicle in front drives off » .

When the ACC halts the vehicle (e.g. traffic jam), the instrument panel display shows the **ACC ready to start** message. If the vehicle ahead drives off again, the ACC will also do so automatically.

If the vehicle ahead does not drive off again, the vehicle can be kept indefinitely in the **ACC ready to start** status by operating the third lever repeatedly towards position ② » **Fig. 198** or by pressing the brake pedal. If the **Press the brake** message is shown on the instrument panel, press the brake. If you do not, an acoustic warning will be heard and the ACC will switch to inactive mode (Standby). At this point, the vehicle may begin to move towards the stopped vehicle ahead » **△**.

Overtaking

When the turn signal lights up before the vehicle begins an overtaking manoeuvre, the ACC accelerates the vehicle automatically and thus reduces the distance from the vehicle in front.

When the vehicle enters the overtaking lane, if the ACC does not detect another vehicle in front, it accelerates until it reaches the programmed speed and maintains it.

System acceleration can be interrupted at any time by pressing the brake or moving the third lever backwards » **page 219**.

Driving through a bend

On entering or exiting bends, the radar sensor may no longer determine the vehicle in front or react to a vehicle in the adjacent lane » **Fig. 201 A**. In these situations the vehicle may brake unnecessarily or fail to react to react to the vehicle in front. In this case, the driver has to intervene by accelerating or interrupting the braking process by applying the brake or pushing the third lever backwards » **page 219**.

Driving in tunnels

When driving through tunnels the radar sensor may be limited. Switch off the ACC in tunnels.

Narrow or misaligned vehicles

The radar sensor can only detect narrow or misaligned vehicles when they are within range » **Fig. 201 B**. This applies particularly to narrow vehicles such as motorbikes. In these cases, you should brake as necessary.

Vehicles with special loads and accessories

Special loads and accessories of other vehicles that jut out over the sides, backwards or over the top may be out of the ACC's range.

Switch off the ACC when driving behind vehicles with special loads and accessories or when overtaking them. In these cases, you should brake as necessary.

Other vehicles changing lanes

Vehicles changing lanes a short distance away from your own can only be detected when they are within range of the sensors. Consequently, the ACC will take longer to react » **Fig. 202 C**. In these cases, you should brake as necessary.

Stationary vehicles

The ACC does not detect stationary objects while driving, such as traffic tails or damaged vehicles.

If a vehicle detected by the ACC turns or moves over and there is a stationary vehicle in front of it, the ACC will not react to it » **Fig. 202 D**. In these cases, you should brake as necessary.

Vehicles driving in the opposite direction and vehicles crossing your path

The ACC does not react to vehicles approaching from the opposite direction or vehicles crossing your path.

Metal objects

Metal objects, e.g. rails on the road or sheets used in road works, can confuse the radar sensor and cause the ACC to react wrongly.

Factors that may affect how the radar sensor operates

If laser sensor operation is impaired, due to heavy rain, spray, snow or mud, the ACC is deactivated temporarily. The relevant text message will appear in the dash panel display. If necessary, clean the radar sensor » **Fig. 197.**

When the radar sensor begins to operate properly again, the ACC will automatically be available again. The message on the instrument panel screen will switch off and the ACC will be reactivated again.

ACC operation may be affected by a strong radar reverse reflection, for example in a closed car park.

Trailer mode

When driving with trailer the ACC controls less dynamically.

Overheated brakes

If the brakes overheat, for example after abrupt braking or in long and steep slopes, the ACC may be deactivated temporarily. The relevant text message will appear in the dash panel display. In this case, adaptive cruise control cannot be activated.

Adaptive cruise control can be reactivated once brake temperature has cooled sufficiently. The message will disappear from the instrument panel display. If the message **ACC**

not available remains on for quite a long time it means that there is a fault. Contact a specialised workshop. SEAT recommends visiting a SEAT dealership.

WARNING

If you do not heed the Press the brake message, the vehicle may initiate an involuntary movement and could crash into the vehicle ahead. In any event, before driving off, check that the road is clear. The radar sensor may not detect obstacles on the road. This could cause an accident and serious injuries. If necessary, apply the brake.

SEAT Drive Profile*

Introduction

SEAT Drive Profile enables the driver to choose between four profiles or modes, **Normal**, **Sport**, **Eco** and **Individual**, that modify the behaviour of various vehicle functions, providing different driving experiences.

The **Individual** profile can be configured according to personal preferences. The other profiles are fixed.

Description

Depending on the equipment fitted in the vehicle, SEAT Drive Profile can operate on the following functions:

Engine

Depending on the profile selected, the engine responds more spontaneously or more in harmony with the movements of the accelerator. Additionally, when **Eco** mode is selected, the Start-stop function is automatically activated.

In vehicles with automatic transmission, the gear change points are modified to position them in lower or higher engine speed ranges. Additionally, the **Eco** mode activates the Inertia function, enabling consumption to be further reduced.

In manual gearbox vehicles, **Eco** mode causes the gear change recommendation indications that appear on the instrument panel to vary, facilitating more efficient driving.

“Dual Ride” suspension

The “Dual Ride” suspension features a comfortable suspension in the **Eco** and **Normal** profiles, suitable for daily use. Contrasting with this it features a sporty suspension in »

the **Sport** profile, suitable for a sporty driving style. In the **Individual** profile the suspension can be switched between **Normal** or **Sport**, depending on personal preference.

In the event of a fault in the “Dual Ride” suspension, the following message is displayed on the instrument panel screen **Fault: damping setting**.

Address

Power steering becomes more robust in **Sport** mode to enable a sportier driving style.

Air conditioning

In vehicles with Climatronic, this can operate in **eco** mode, especially restricting fuel consumption.

Adaptive Cruise Control (ACC)

According to the active driving profile, the acceleration gradient of the adaptive cruise control varies.

Setting driving mode



Fig. 203 Next to the gearbox lever: MODE button.

You can select from **Normal**, **Sport**, **Eco** and **Individual**.

You can select the required mode either by repeatedly pressing the button **MODE** **»» Fig. 203**, or on the touch screen, in the menu that opens when the above button is pressed.

An icon on the Easy Connect system display informs about the active mode.

The **MODE** button light remains lit up yellow when the active mode is different to **Normal**.

Driving profile	Characteristics
Normal	Offers a balanced driving experience, suitable for everyday use.

Driving profile	Characteristics
Sport	Provides a complete dynamic performance in the vehicle, enabling the user a more sporty driving style.
Eco	Places the vehicle in a particularly low state of consumption, facilitating a fuel-saving driving style that is respectful to the environment.
Individual	Enables some configurations to be modified by pressing the Profile settings button. The functions that can be adjusted depend on the equipment fitted in the vehicle.

⚠ WARNING

When operating SEAT Drive Profile, pay attention to all traffic: doing otherwise could cause an accident.

i Note

- **When the vehicle is switched off it will always store the driving profile that was selected when the ignition key was removed. Nevertheless, when the engine is restarted, the engine and the gear will not restart in the setting selected. For engine and gear to revert to the desired position, select the corresponding drive profile again or press the Easy Connect system button repeatedly.**

- Your speed and driving style must always be adjusted to visibility, weather, and traffic conditions.
- The Eco profile is not recommended when towing a vehicle.

Kick-down

The kick-down feature allows maximum acceleration to be reached.

If the **eco*** » page 226 mode has been selected in SEAT Drive Profile*, and the accelerator is pressed beyond a hard point, the engine power is automatically controlled to give your vehicle maximum acceleration.

WARNING

Please note that if the road surface is slippery or wet, the kick-down feature could cause the driving wheels to spin, which could result in skidding.

Fatigue detection (break recommendation)*

Related video



BKJ-0099

Fig. 204 Safety

Introduction

The Fatigue detection informs the driver when their driving behaviour shows signs of fatigue.

WARNING

Do not let the comfort afforded by the Fatigue detection system tempt you into taking any risks when driving. Take regular breaks, sufficient in length when making long journeys.

- The driver always assumes the responsibility of driving to their full capacity.
- Never drive if you are tired.
- The system does not detect the tiredness of the driver in all circumstances. Consult the information in the section » page 228, System limitations.

- In some situations, the system may incorrectly interpret an intended driving manoeuvre as driver tiredness.
- No warning is given in the event of the effect called microsleep!
- Please observe the indications on the instrument panel and act as is necessary.

Note

- Fatigue detection has been developed for driving on motorways and well paved roads only.
- If there is a fault in the system, have it checked by a specialised workshop.

Function and operation





BSF-0421

Fig. 205 On the instrument panel display: fatigue detection symbol.

Fatigue detection determines the driving behaviour of the driver when starting a journey, »

making a calculation of tiredness. This is constantly compared with the current driving behaviour. If the system detects that the driver is tired, an audible warning is given with a sound and an optic warning is shown with a symbol and complementary message on the instrument panel display » **Fig. 205**. The message on the instrument panel display is shown for approximately 5 seconds, and depending on the case, is repeated. The system stores the last message displayed.

The message on the instrument panel display can be switched off by pressing the **OK/RESET** button on the windscreen wiper lever or the button **OK** on the multi function steering wheel »  page 37.

The message can be recalled to the instrument panel display using the multifunction display »  page 37.

Conditions of operation

Driving behaviour is only calculated on speeds above about 65 km/h (40 mph) up to around 200 km/h (125 mph).

Switching on and off

Fatigue detection can be activated or deactivated in the Easy Connect system with the **CAR** button and the **SETTINGS** function button »  page 34. A mark indicates that the adjustment has been activated.

System limitations

The Fatigue detection has certain limitations inherent to the system. The following conditions can limit the Fatigue detection or prevent it from functioning.

- At speeds below 65 km/h (40 mph)
- At speeds above 200 km/h (125 mph)
- When cornering
- On roads in poor condition
- In unfavourable weather conditions
- When a sporty driving style is employed
- In the event of a serious distraction to the driver

Fatigue detection will be restored when the vehicle is stopped for more than 15 minutes, when the ignition is switched off or when the driver has unbuckled their seat belt and opened the door.

In the event of slow driving during a long period of time (below 65 km/h, 40 mph) the system automatically re-establishes the tiredness calculation. When driving at a faster speed the driving behaviour will be recalculated.

Parking aid (Park Pilot)

General information

Assorted assistance systems – which vary depending on the equipment fitted in the car – will help you when parking or manoeuvring.

The **rear parking aid** is an audible assistant that warns about obstacles located *behind* the vehicle » page 229.

During parking, **Parking System Plus** assists the driver by visually and audibly warning them about obstacles detected *in front* and *behind* the vehicle » page 230.

WARNING

- Always pay attention, also when looking straight ahead, to traffic and the vehicle surroundings. The assistance systems are not a replacement for driver awareness. When inserting or removing the vehicle from a parking space, or when performing similar manoeuvres the driver always assumes the responsibility.
- Adapt your speed and driving style at all times to suit visibility, weather, road and traffic conditions.
- The ultrasound sensors have blind spots in which obstacles and people are not registered. Pay special attention to children and animals.

- Always keep visual control of the vehicle surroundings: use the mirrors for additional help.

ⓘ CAUTION

Parking Aid functions may be negatively affected by different factors that may lead to damage to the vehicle or its immediate surroundings:

- Under certain circumstances, the system does not detect or display certain objects:
 - Objects such as chains, trailer draw bars, fences, posts and thin trees.
 - Objects that are located above the sensors, such as protrusions in a wall.
 - Objects with certain surfaces or structures, such as wire mesh fences or powder snow.
- Certain surfaces of objects and garments do not reflect the ultrasound sensors' signals. The system cannot detect, at least correctly, these objects or people wearing such clothes.
- Ultrasound sensor signals may be affected by external sound sources. In certain circumstances this may prevent them from detecting people or objects.
- Please note that low obstacles detected by the system may no longer be registered by the sensors as the car moves closer, so the system will not give any further warning. In certain circumstances, objects such as high

kerbs that could damage the bottom of the vehicle are not detected either.

- If the first warning from the ParkPilot is ignored, the vehicle could suffer considerable damage.
- The knocks or damage on the radiator grille, bumper, wheel arch and vehicle underbody can adjust the orientation of the sensors. This can affect the parking aid function. Have the function checked by a specialised workshop.

ⓘ Note

- In certain situations, the system can give a warning even though there is no obstacle in the detected area, e.g:
 - with rough or cobbled floors or ground with long grass;
 - with external ultrasound sources, such as cleaning vehicles or other vehicles;
 - In downpours, intense snow or dense exhaust gases;
 - or in locations such as the brow of a hill.
- A registration plate or plate holder on the front with larger than the space for the registration plate, or a registration plate that is curved or warped can cause:
 - false detections,
 - loss of sensor visibility,
- In order to guarantee good system operation, keep the ultrasound sensors clean, free

of snow or ice, and do not cover them with adhesives or other objects.

- If you use high-pressure or vapour equipment to clean the ultrasound sensors, apply it directly only very briefly and always from a distance of more than 10 cm.
- Retrofitting of accessories to the vehicle, such as a bicycle rack, may interfere with the operation of the Parking Aid.
- In order to familiarise yourself with the system, it is advised that you practice parking in an area or car park that is free from traffic. There must be good weather and light conditions.
- The volume and tone of the warnings can be modified, in addition to the indications »» page 232.
- In vehicles *without* a driver information system, these parameters can be modified in a SEAT Official Service or in a specialised workshop.
- Please observe information on towing a trailer »» page 233.
- The display on the Easy Connect screen shows a slight time delay.

Rear parking aid*

The rear Parking Aid assists the driver in parking by means of audible warning sounds.



Description

There are sensors integrated in the rear bumper. When the sensors detect an obstacle, you are alerted by audible warnings.

Make particularly sure that the sensors are not covered by adhesives, residues and the like, as this could affect the system's operation. Cleaning instructions ►► page 251.

The approximate measurement range of the rear sensors is:

side area	0.60 m
central area	1.60 m

As you approach the obstacle, the time interval between the audible warnings will be reduced. When you reach around 0.30 m the warning will be constant: Do not continue to move forward (or backward) ►► ⚠ in General information on page 228, ►► 📍 in General information on page 229 !

If you maintain separation from the obstacle, the volume of the warning begins to reduce after four seconds (does not affect the tone of the constant warning).

Activating/Deactivating

When engaging reverse gear, the parking aid is automatically switched on. This is confirmed with a short warning.

On disengaging reverse gear, the Parking Aid system is disconnected immediately.

Parking Aid Plus*

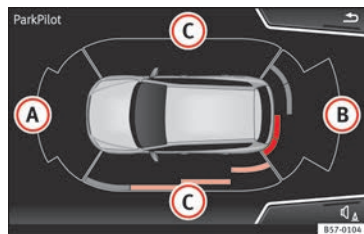

Fig. 206 Represented area.

During parking, **Parking System Plus** assists the driver by visually and audibly warning them about obstacles detected *in front of* and *behind* the vehicle.

There are ultrasound sensors integrated in the front and rear bumpers. When they detect an obstacle, you are alerted by audible warnings and visually on the Easy Connect system.

In the event of danger of a frontal collision, the audible warnings come from the front of the vehicle, and in the event of the danger of a rear-end collision they come from the rear.

Make particularly sure that the sensors are not covered by adhesives, residues and the like, as this could affect the system's operation. Cleaning instructions ►► page 251.

The approximate measurement range of the sensors is:

- Ⓐ 1.20 m
- Ⓑ 1.60 m
- Ⓒ 0.90 m

As you approach the obstacle, the time interval between the audible warnings will be reduced. When you reach around 0.30 m the warning will be constant: do not continue to move forward (or backward)!

If you maintain separation from the obstacle, the volume of the warning begins to reduce after four seconds (does not affect the tone of the constant warning).

In order to view the entire periphery of the vehicle, the vehicle must be moved a few metres forwards and backwards. Thus, the missing areas are screened and obstacles at the sides of the vehicle are displayed ►► Fig. 206 Ⓒ.

Parking Aid operation



Fig. 207 Centre console: parking aid button.

Manual connection of Parking Aid

- Press the **P** button *once*. The symbol on the button will light up yellow.

Manual disconnection of Parking Aid

- Press the **P** button *again*.

Manual disconnection of Parking Aid display (the audible sounds remain active)

- Press a button on the main menu of the factory-assembled infotainment system.
- **OR:** press the **X** function button in the top right corner.

Automatic connection of Parking Aid

- Engage reverse gear or turn the selector lever to position **R**.

- **OR:** If the vehicle approaches an obstacle that is in its forwards path at a speed below 10 km/h (6 mph) **»» page 231, Automatic activation**. The obstacle is detected as of a distance of approx. 95 cm if the automatic connection is activated in the infotainment system. A reduced display is shown.

- **OR:** the vehicle moves backwards.

Automatic disconnection of Parking Aid

- Move the selector lever to position **P**.
- **OR:** accelerate to more than approx. 10 km/h (6 mph) forward.

Temporary suppression of sound in Parking Aid

- Press the **M** function button on the infotainment system display.

Change from reduced view to full view

- Engage reverse gear or turn the selector lever to position **R**.
- **OR:** press the car icon in reduced view.

If necessary, switch to the rear-assist image (Rear View Camera “RVC”)

- Engage reverse gear or turn the selector lever to position **R**.
- **OR:** Press the **RVC** function button **»» page 236**.

A short confirmation signal will be heard and the button symbol will light up yellow when the system is switched on.

Automatic activation



Fig. 208 Miniature indication of automatic activation.

When the Parking System Plus is switched on automatically, a miniature of the vehicle will be displayed and the segments will be shown on the left side of the screen **»» Fig. 208**.

Automatic activation occurs when slowly approaching an obstacle located in front of the vehicle. It only operates every time the speed is reduced below approximately 10 km/h (6 mph) for the first time.

If the parking aid is switched off using the **P** button, the following actions must be carried out in order for it to automatically switch on: **»»**

- Switch off the ignition and switch it on again.
- **OR:** accelerate above 10 km/h (6 mph) before reducing speed below this number again.
- **OR:** place the selector lever in position **P** and then move it from this position.
- **OR:** switch on and off the automatic activation in the Easy Connect system menu.

The automatic activation with parking aid miniature indication can be switched on and off from the Easy Connect system menu

»  page 34:

- Switch the ignition on.
- Select: **CAR** button > **Settings** > **Parking and manoeuvring**.
- Select the **Automatic activation** option. When the function button check box is activated , the function is on.

If the system has been activated automatically, an audible sound warning will only be given when obstacles in front are at a distance of less than 50 cm.

CAUTION

The automatic connection of the Parking Aid only works when you are driving slowly. If driving style is not adapted to the circumstances, an accident and serious injury or damage may be caused.

Segments of the visual indication

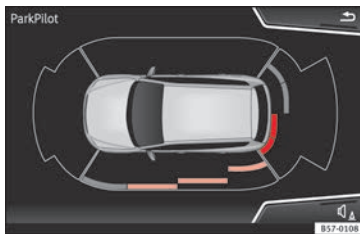

Fig. 209 Parking Aid display on the Easy Connect system screen.

The distance of separation from the obstacle can be estimated using the segments around the vehicle.

The optical indication of the segments works as follows:



White segments: a white segment is displayed when the obstacle is not within the vehicle's trajectory or the direction of travel is in the opposite direction to its location, and it is more than 30 cm from the vehicle.

Yellow segments: obstacles located in the vehicle's trajectory and which are more than 30 cm away from the vehicle are displayed in yellow.

Red segments: obstacles that are less than 30 cm away from the vehicle are displayed in red.

Moreover, with the SEAT Media System Plus/Navi System radios, a yellow trail indicates the vehicle's expected journey based on the steering wheel angle.

Whenever the obstacle is located in the vehicle's direction of travel, the corresponding audible warning will sound.

As the vehicle approaches an obstacle, the segments are displayed closer to the vehicle. When the penultimate segment is displayed, this means that the vehicle has reached the collision zone. In the collision zone, the obstacles are represented in red, including those out of the path. Do not continue to move forward (or backward) »  in **General information on page 228**, »  in **General information on page 229**!

Adjusting the display and audible warnings

The settings for the display and audible warnings are controlled via the Easy Connect*.

Automatic activation

on – activates the **Automatic activation** option » page 231.

off – deactivates the **Automatic activation** option » page 231.

Front volume*

Volume in the front and rear area.

Front sound settings/sharpness*

Frequency (tone) of the sound in the front area.

Rear volume*

Volume in the rear area.

Rear sound settings/sharpness*

Frequency (tone) of the sound in the rear area.

Adjust volume

With the parking aid switched on, the active audio/video source volume will be reduced to the intensity of the selected setting.

Error messages

When the Parking Aid is activated or when it is switched on, if a message reporting a Parking aid error is displayed on the instrument panel, there is a fault in the system.

If the fault does not disappear before disconnecting the ignition, the next time that the parking aid is engaged in reverse, no audible

signal of the existence of a fault will be issued.

Parking System Plus*

If there is a fault in the parking aid system a message will appear on the instrument panel indicating the error. In addition the **P** key LED will blink.

If there is a fault in a sensor, the symbol  is displayed on the Easy Connect display in front of/behind the vehicle. If a rear sensor is faulty, only the obstacles in area **(A)** are displayed » **Fig. 206**. If a front sensor is faulty, only the obstacles in area **(B)** are displayed.

Have the fault corrected by a specialised workshop without delay.

Towing bracket

In vehicles equipped with a towing bracket device from the factory, when the trailer is connected electrically, the Parking Aid rear sensors will not be activated when reverse gear is engaged, when the selector lever is turned to position **R** or when the button **P** is pressed.

Parking System Plus

The distance to possible obstacles at the rear of the vehicle will not be displayed on the

screen and nor will it be indicated by means of audible sound signals.

The Easy Connect system screen will only display objects detected at the front, and the vehicle's trajectory will be hidden.

Braking while manoeuvring function*

✓ Only valid with Parking System Plus

The emergency braking function is used to minimise damage in the event of a collision.

Depending on the equipment, if the Parking Aid is active, the braking while manoeuvring function activates emergency braking when it detects an obstacle in the vehicle's path that could cause a collision, driving forwards or in reverse.

The function will not brake if the Parking Aid is activated automatically. For the system to operate, manoeuvring speed must be between 2.5 and 10 km/h (between 1.5 and 6 mph) for the front area and between 1.5 and 10 km/h (between 1 and 6 mph) for the rear.

Following an intervention, the braking while manoeuvring function will be inactive in the same direction of travel for 5 metres. Once the gear is changed, or the selector lever's position is changed, the function will be active again. The Parking Aid's limitations apply.

»

The braking while manoeuvring function is controlled in the Easy Connect system with the **CAR** menu and the **SETTINGS** and **Park and manoeuvre** function buttons.

- **on** – permits the use of the braking while manoeuvring function.
- **off** – does not permit the use of the braking while manoeuvring function.

Temporary suppression of emergency braking

- When the function is deactivated with the **Braking while manoeuvring** button that appears on the **Parking System** screen of the Easy Connect system.
- Whenever any of the car doors, rear lid or bonnet are opened.

Rear Assist “Rear View Camera”*

Related video



Fig. 210 Safety

BKJ-0099

Operating and safety warnings

⚠ WARNING

- The Rear Assist does not make it possible to precisely calculate the distance from obstacles (people, vehicles, etc.) and nor can it overcome the system's own limits, hence using it may cause serious accidents and injuries if used negligently or without due care. The driver should be aware of his/her surroundings at all times to ensure safe driving.
- The camera lens expands and distorts the field of vision and displays the objects on the screen in a different, vague manner. The perception of distances is also distorted by this effect.
- Due to the screen resolution or insufficient light conditions, some items may be displayed in an unsatisfactory manner or not at all. Take special care with thin posts, fences, railings or trees that might not be displayed on screen and could damage the vehicle.
- The rear assist has blind spots where it is not possible to represent people or objects (small children, animals and certain objects cannot be detected in its field of vision). Monitor the vehicle's surrounding area at all times.
- Keep the camera lens clean, free of ice and snow, and do not cover it.
- The system is not a replacement for driver awareness. Supervise the parking operation at all times, as well as the vehicle's surrounding area. Adapt your speed and driving style

at all times to suit visibility, weather, road and traffic conditions.

- Do not be distracted from the traffic by looking at the screen.
- The images on the rear assist screen are only two-dimensional. Due to a lack of spatial depth, protruding parts or holes in the road, for example, are more difficult to detect or may not be seen at all.
- Vehicle load modifies the representation of the orientation lines displayed. The width represented by the lines diminishes with vehicle load. Pay special attention to the vehicle's surroundings when the inside of the vehicle of the luggage compartment is carrying a heavy load.
- In the following situations, the objects or other vehicles shown in the navigation system display appear to be further away or closer than they really are: Pay special attention:
 - On moving from a horizontal plane to a slope.
 - On moving from a slope to a horizontal plane.
 - If the vehicle is heavily loaded at the rear.
 - When the vehicle approaches objects that are not on the ground surface or are jutting out from it. These objects may also be outside the camera's angle of vision when reversing.

 Note

- It is important to take great care and pay special attention if you are not yet familiar with the system.
- Rear assist will not be available if the vehicle's rear lid is open.

Instructions for use

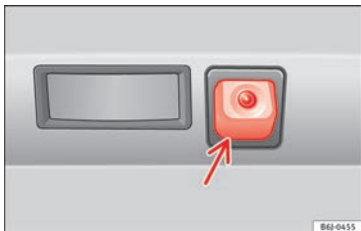



Fig. 211 On the rear bumper: location of the rear assist camera.

A camera on the rear bumper aids the driver during reverse parking or manoeuvring » **Fig. 211**. The camera image is viewed together with orientation lines projected by the system on the Infotainment system screen. The bottom of the screen displays part of the bumper, which can be used by the driver as a reference point.

Rear assist settings

Rear assist offers the user the possibility to change the image's *brightness, contrast* and *colour* settings.

To change these settings:

- Park the vehicle in a safe place.
- Apply the parking brake.
- Switch the ignition on.
- If necessary, switch on the Infotainment system.
- Engage reverse gear or turn the selector lever to position **R**.
- Press the  function button displayed on the right of the image.
- Make the desired adjustments on the menu by pressing the $-/+$ function buttons or by moving the corresponding scroll button.

Necessary conditions for parking and manoeuvring with the rear assist

The system should not be used in the following cases:

- If the image displayed is not very reliable or is distorted, for example low visibility or dirty lens.
- If the area behind the vehicle is not displayed very clearly or is incomplete.
- If the vehicle is heavily loaded at the rear.

- If the position and installation angle of the camera have been changed, e.g. after a rear-end collision. Have the system checked by a specialised workshop.

Familiarising yourself with the system

To familiarise yourself with the system, the orientation lines and their function, SEAT recommends practising parking and manoeuvring with the rear assist in a place without too much traffic or in a car park when there are good weather and visibility conditions.

Cleaning the camera lens

Keep the camera lens clean and clear of snow and ice:

- Moisten the lens using a normal alcohol-based glass cleaning product and clean the lens with a dry cloth.
- Remove snow using a small brush.
- Use de-icing spray to remove any ice.

 CAUTION

- **Never use abrasive cleaning products to clean the camera lens.**
- **Do not use hot or warm water to remove ice or snow from the camera lens. Doing so could damage the camera.**

Parking and manoeuvring with the rear assist

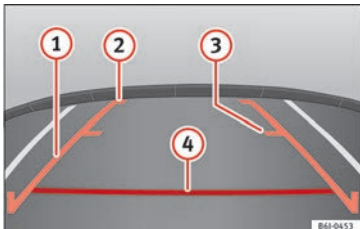

Fig. 212 Display on the Infotainment system screen: orientation lines.

Switching the system on and off

- The rear assist will switch on when the ignition is on or the engine running, on engaging reverse gear (manual gearbox) or on changing the selector lever to the **R** position (automatic gearbox).
- The system switches off 8 seconds after disengaging reverse gear (manual gearbox) or removing the selector lever from the **R** position (automatic gearbox). The system will also disconnect immediately after the ignition is switched off.

¹⁾ **WARNING:** the **RVC** (Rear View Camera) function button will only be activated and available when the reverse gear is engaged or the selector lever is set to position **R**.

- The camera will stop transmitting images above the speed of 15 km/h (9 mph) with reverse engaged.

In combination with the Parking System Plus » page 228, the camera image will cease to be transmitted immediately when reverse gear is disengaged or when the selector lever is moved from the **R** position, and the optical information provided by the Parking Aid system will be displayed.

Also in combination with the system, the rear assist image can also be concealed:

- By pressing one of the Infotainment system buttons on the display.
 - **OR:** By pressing the miniature vehicle that appears on the left of the screen (which switches to the full-screen mode of the Parking System Plus's optical system).
- If you wish to display the rear assist image again:
- Disengage reverse, or change the selector lever's position, engage reverse again or move the selector lever to position **R**.
 - **OR:** Press the **RVC** function button¹⁾

Meaning of the orientation lines

» Fig. 212

- 1 **Side lines:** extension of the vehicle (the approximate width of the vehicle plus the rear view mirrors) on the road surface.
- 2 **End of the side lines:** the area marked in green ends approximately 2 m behind the vehicle on the road surface.
- 3 **Intermediate line:** indicates a distance of approximately 1 m behind the vehicle on the road surface.
- 4 **Red horizontal line:** indicates a safe distance of approximately 40 cm at the rear of the vehicle on the road surface.

Parking manoeuvre

- Place the vehicle in front of the parking space and engage reverse gear (manual gearbox) or move the selector to the **R** position (automatic gearbox).
- Reverse slowly, and turn the steering wheel so that the side orientation lines lead towards the parking space.
- Guide the vehicle into the parking space so that the side orientation lines run parallel to it.

Towing bracket device

Towing bracket device*

Introduction

The towing bracket device fitted to your vehicle, be it factory-fitted or a genuine SEAT accessory, meets all the national technical and legal requirements for towing.

Your vehicle is fitted with a 13-pin connector for the electrical connection between the trailer and the vehicle. If the trailer is equipped with a **7-pin connector** you can use the corresponding adaptor, which is available as a genuine SEAT accessory.

The maximum authorised towing load is **50 kg**.

⚠ WARNING

- Before each journey, make sure that the detachable ball joint is properly fitted and secured in its housing.
- If the detachable ball joint is not properly fitted and secured, do not use it.
- Do not use the towing bracket device for towing if it is damaged or has missing parts.
- Do not modify or adapt the towing device connection.
- Never unhook the detachable ball joint when the trailer is hitched.

⚠ CAUTION

Handle the detachable ball joint with care in order to avoid damaging the bumper paintwork.

i Note

Towing the vehicle with the detachable ball joint » page 102.

Description

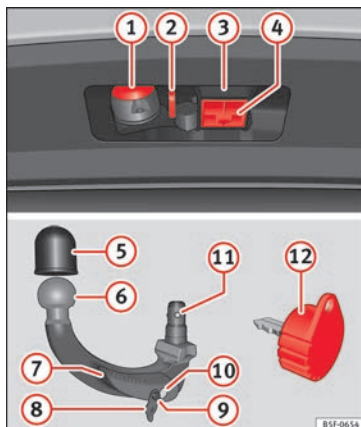

Fig. 213 Towing bracket device support / detachable ball joint / key.

Depending on the country or version, the towing bracket device's detachable ball joint is located:

- underneath the floor panel of the luggage compartment.

The ball joint is fitted and removed by hand.

The towing device bracket is supplied with a key.

Key to » **Fig. 213**

- ① 13-pin connector
- ② Safety lug
- ③ Hook housing
- ④ Hook housing cap
- ⑤ Ball protective cover
- ⑥ Detachable ball
- ⑦ Locking lever
- ⑧ Lock cover
- ⑨ Release bolt
- ⑩ Lock
- ⑪ Locking balls
- ⑫ Key

i Note

Contact an Authorised Service Partner if you lose your key.

Placing in standby position

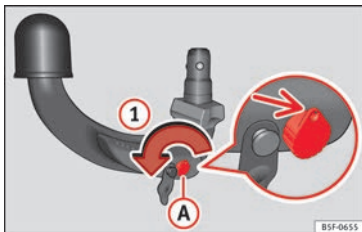

Fig. 214 Step 1.

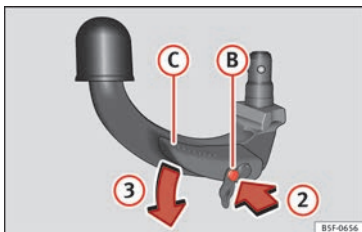

Fig. 215 Step 2.

Before assembling it, place the detachable ball in the standby position with the following two steps.

Step 1.

- Turn the key in the direction of arrow ① until the part of the key with the holes reaches the top position »» Fig. 214 (arrow).

Step 2.

- Grip the detachable ball below the protective cover.
- Press the release bolt ② in the direction of arrow ②, and at the same time press lever ③ in the direction of arrow ③ as far as it will go »» Fig. 215.

The lever will remain blocked in this position.

Standby position

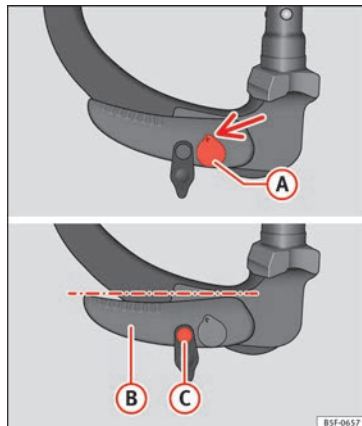

Fig. 216 Standby position: Position of the lever and the release bolt.

Standby position adjusted properly

- Key ① »» Fig. 216 is in the released position (the part of the key with the holes is facing upwards).
- Lever ② »» Fig. 216 is in the bottom position.
- The release bolt ③ »» Fig. 216 can be moved.

Thus adjusted, the detachable ball is ready for installation.

① CAUTION

The key cannot be removed or turned in the standby position.

Assembling the detachable ball - Step 1

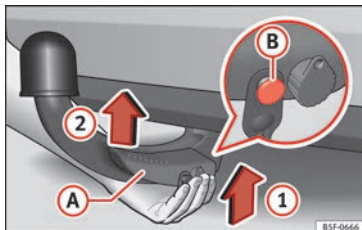

Fig. 217 Fitting the detachable ball / Release bolt in the deployed position.

Fitting the detachable ball

- Remove the hook housing cap ④
»» Fig. 213 downwards.
- Set the detachable ball to its standby position »» page 238.
- Grip the detachable ball **from below**
»» Fig. 217 and insert it into the hook hous-

ing following the direction of arrow ① until it engages audibly »» ⚠.

Lever A turns **automatically** in the direction of arrow ② upwards, and the release bolt B moves outwards (the red and green part will be visible) »» ⚠.

If lever A does not turn automatically or the release bolt B does not come out, the detachable ball should be removed by turning the lever as far as possible downwards from the housing cavity, and the detachable ball's support surfaces and the cavity should then be cleaned.

⚠ WARNING

- When attaching the detachable ball, keep your hands well away from the reach of the lever's rotation to avoid getting your fingers caught.
- Never try to pull the lever upwards by force to turn the key. The detachable ball would not be secured properly!

Assembling the detachable ball - Step 2

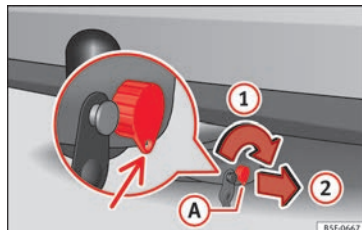

Fig. 218 Locking the lock.

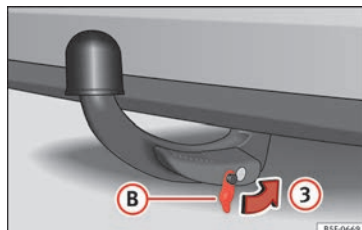

Fig. 219 Placing the cover over the lock.

Do not omit this first step »» page 239, Assembling the detachable ball - Step 1 !

- Turn key A in the direction of arrow ① until the part of the key with the holes reaches the bottom position »» Fig. 218.

- Remove the key in the direction of arrow ②.
- Place cover ① in the lock in the direction of arrow ③ » Fig. 219 » ①.
- Check that the detachable ball is securely attached » page 240, Checking proper attachment.

ⓘ CAUTION

- After removing the key, always place the cover over the lever's lock. If the lock becomes soiled it will be impossible to insert the key.
- Keep the towing bracket device's housing cavity clean at all times. Dirtiness can prevent the detachable ball from being properly secured!
- If the detachable ball is removed, always place the cap on the hook's housing.

Checking proper attachment

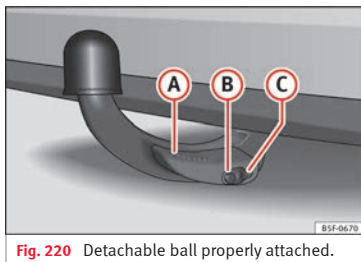

Fig. 220 Detachable ball properly attached.

Whenever you go to use the detachable ball, make sure that it is properly attached first.

Detachable ball properly attached.

- The detachable ball will not fall out of the housing cavity after a major "knock or jerk".
- Lever ① » Fig. 220 is fully raised.
- The release bolt ② » Fig. 220 is sticking fully out (the red and green part is visible).
- The key has been removed.
- Cover ③ » Fig. 220 is placed over the lock.

⚠ WARNING

- When removing the detachable ball, keep your hands well away from the reach of the lever's rotation to avoid getting your fingers caught.

- The towing bracket device should only be used if the detachable ball has been properly locked!

Removing the detachable ball - Step 1

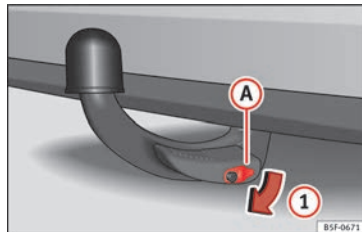

Fig. 221 Removing the lock cover.

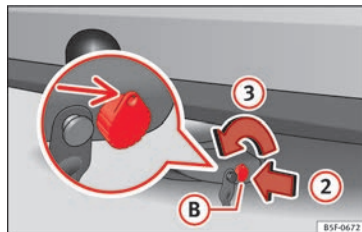

Fig. 222 Releasing the lock.

- Remove cover ① from the lock in the direction of arrow ① » Fig. 221.

- Insert key **(B)** into the lock in the direction of arrow **(2)** » Fig. 222.
- Turn the key in the direction of arrow **(3)** until the part of the key with the holes is facing upwards.

⚠ WARNING

Never remove the detachable ball joint when the trailer is hitched.

i Note

Before you remove the detachable ball, you are advised to place the protective cover on the ball coupling.

Removing the detachable ball - Step 2

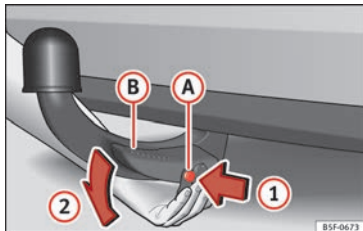

Fig. 223 Releasing the detachable ball.

Do not omit this first step » page 240, Removing the detachable ball - Step 1 !

Releasing the detachable ball

- Grip the detachable ball from below.
- Press the release bolt **(A)** in the direction of arrow **(1)** as far as it will go, and at the same time press lever **(B)** in the direction of arrow **(2)** as far as it will go.

In this position, the detachable ball is loose and will fall/drop freely downwards. If this does not occur when you release it, press it with the other hand from above.

The detachable ball locks into the standby position at the same time and is therefore ready to be reinserted into the hook housing » **!**

- Fit the cap **(4)** » Fig. 213 onto its housing.

⚠ WARNING

Never leave the detachable ball loose in the luggage compartment. It could cause damage in the luggage compartment in the case of abrupt braking, and even jeopardise passenger safety!

ⓘ CAUTION

- If you hold the lever and do not press down on it as far as you can, after you remove the detachable ball, the latter will continue upwards and will not lock into the standby position. The detachable ball should be placed in this position before the next assembly.

- Keep the detachable ball in the standby position, with the key inserted into the box while you place it facing downwards with the side opposite to the one where the key is inserted. The key could get damaged!
- When operating the lever, do not apply too much pressure (for example, do not stand on it)!

i Note

Remove any dirt from the detachable ball before you put it away with the vehicle tools.

Operation and care

Put the cover on the housing cavity so that dirt cannot get in.

Before hooking up a trailer, always check the ball coupling and apply suitable grease if necessary.

Use the protective cover when putting the detachable ball away to keep the luggage compartment clean.

Remove any dirt from the housing cavity surfaces and use a suitable cleaning product.

ⓘ CAUTION

The top part of the hook housing is greased. Make sure that the grease has not been removed.

Trailer towing

What do you need to bear in mind when towing a trailer?

Your vehicle may be used to tow a trailer when fitted with the correct equipment.

If you wish to **retrofit** a towing bracket, consult » page 245.

Connectors

Your vehicle is fitted with a 13-pin connector for the electrical connection between the trailer and the vehicle.

If the trailer has a **7-pin plug** you will need to use an adapter cable. It is available at any Technical Service.

Trailer weight/drawbar load

Never exceed the authorised trailer weight. If you do not load the trailer up to the maximum permitted trailer weight, you can then climb correspondingly steeper slopes.

The maximum trailer weights listed are only applicable for **altitudes** up to 1000 m above sea level. With increasing altitude the engine power and therefore the vehicle climbing ability are impaired because of the reduced air density. The maximum trailer weight has to be reduced accordingly. The weight of the vehicle and trailer combination must be re-

duced by 10% for every further 1000 m (or part thereof). The gross combination weight is the actual weight of the laden vehicle plus the actual weight of the laden trailer. When possible, operate the trailer with the maximum permitted **drawbar load** on the ball joint of the towing bracket, but do not exceed the specified limit.

The figures for **trailer weights** and **drawbar loads** that are given on the data plate of the towing bracket are for certification purposes only. The correct towing bracket figures for your specific model, which may be *lower than these figures*, are given in the vehicle documentation or on » page 281, **Technical specifications**.

Distributing the load

Distribute loads in the trailer so that heavy objects are as near to the axle as possible. Loads carried in the trailer must be secured to prevent them moving.

Tyre pressure

The maximum permissible tyre pressure values are shown on the sticker on the rear part of the left front door frame. Set the tyre pressure of the trailer tyres in accordance with the trailer manufacturer's recommendations.

Exterior mirrors

Check whether you can see enough of the road behind the trailer with the standard rear vision mirrors. If this is not the case, you should have additional exterior mirrors fitted. Both exterior mirrors should be mounted on hinged extension brackets. Adjust the mirrors to give sufficient vision to the rear.

Tow rope

Always use a cable between the vehicle and the trailer » page 243.

Trailer rear lights

The trailer's rear lights should comply with the statutory safety regulations » page 243.

WARNING

Never transport people in a trailer. This could result in fatal accidents.

Note

- **Towing a trailer places additional demands on the vehicle. We recommend additional services between the normal inspection intervals if the vehicle is used frequently for towing a trailer.**
- **Find out whether special regulations apply to towing a trailer in your country.**

Hitching and connecting the trailer

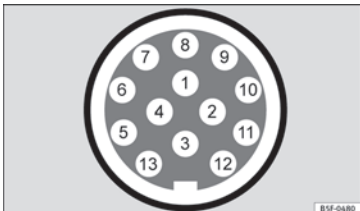

Fig. 224 Schematic diagram: assignment of the pins of the trailer's electrical socket.

Key of the Schematic diagram » Fig. 224:

Pin	Meaning
1	Left turn signal
2	Rear fog light
3	Earth, pins 1, 2, 4 to 8
4	Right turn signal
5	Rear light, right
6	Brake lights
7	Rear light, left
8	Reverse lights
9	Permanent live
10	Cable without positive charge
11	Earth, pin 10

Key of the Schematic diagram » Fig. 224:

Pin	Meaning
12	Unassigned
13	Earth, pin 9

Electrical socket for trailer

The vehicle is fitted with a 13-pole power socket for the electrical connection between the trailer and the vehicle. If the system detects that a trailer has been connected electrically, the electrical equipment on the trailer will receive voltage through this connection.

Pin 9 has a permanent live. This powers, for example, the trailer's interior lighting. Pin 10 is only powered when the engine is running. The charge wire (pin 10) charges, for example, a caravan battery.

Pin 9 and 10 should not be connected to each other to avoid discharging or damaging the vehicle's battery.

The earth wires, pin 3, pin 11 and pin 13, should never be connected to each other to avoid overloading the electrical system.

If the trailer has a **7-contact connector**, you will need to use an adapter cable. In this case the function corresponding to pin 10 will not be available.

Trailer maximum electricity consumption

Brake lights (total)	84 Watts
Turn signal, on each side	42 Watts
Side lights (total)	100 Watts
Rear lights (total)	42 Watts
Rear fog light	42 Watts

Never exceed the values indicated!

Note

- **If the rear lights of the trailer are not correctly connected, the vehicle electronics may be damaged.**
- **If the trailer absorbs excessive electric current, the vehicle electronics may be damaged.**
- **Never connect the trailer's electric system directly to the electrical connections of the tail lights or any other power sources. Only use the connections intended for providing electric current to the trailer.**

Ball coupling of towing bracket device*

The ball coupling is provided with instructions on fitting and removing the ball coupling of the towing bracket.

⚠ WARNING

The towing bracket ball coupling must be stored securely in the luggage compartment to prevent them being flung through the vehicle and causing injury.

i Note

• By law, the ball coupling must be removed if a trailer is not being towed if it obscures the number plate.

Driving with a trailer

Fig. 225 Turn the 13-pin connector.

Before driving

- Grip the 13-pin connector at area **A** and remove it in the direction of the arrow **»» Fig. 225**.
- Remove the protective cover **5** **»» Fig. 213** upwards.

After driving

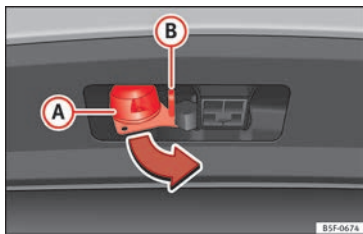
- Grip the 13-pin connector at area **A** and insert it in the opposite direction to the arrow **»» Fig. 225**.
- Fit the protective cover **5** **»» Fig. 213** on the ball coupling.

Safety lug

The safety lug **B** **»» Fig. 225** is used to hook up the trailer's retainer cable.

On hooking it up to the safety lug, the retainer cable should **have slack** in all the trailer positions with respect to the vehicle (sharp bends, reverse gear, etc.).

Headlights

The front part of the vehicle may be raised when the trailer is connected and the light may dazzle the rest of the traffic.

Adapt the height of the headlights using the headlight range rotary adjuster¹⁾.

⚠ WARNING

- Never use the safety lug to tow!
- Adjust your speed to suit the road and traffic conditions.
- All work on the electrical system must be carried out only by specialised workshops.
- Never connect the trailer's electric system to the electrical connections of the rear lights or any other power sources.
- After hooking up the trailer and connecting the socket, check that all the trailer's rear lights are working properly.

i Note

- If there is any fault in the trailer's lighting, check the fuses in the instrument panel fuse box **»»**  page 62.
- The contact between the retainer cable and the safety lug may give rise to mechanical wear in the lug's surface protection. This wear will not prevent the safety lug from operating properly or cause any fault and is excluded from the warranty.
- When connecting and disconnecting the trailer, the towing vehicle's handbrake should be applied.

¹⁾ This does not apply for vehicles with bi-xenon headlights.

Anti-theft alarm

When the vehicle is locked, the alarm is triggered when the electrical connection between vehicle and trailer is interrupted.

Always turn off the anti-theft alarm system before connecting or disconnecting a trailer » page 138.

Conditions for the integration of a trailer in the anti-theft alarm system.

- The vehicle is factory-equipped with an anti-theft alarm system and a towing bracket device.
- The trailer is connected electrically to the towing vehicle by the trailer connector.
- The electrical system of the vehicle and the trailer are prepared for operation.
- The vehicle is locked with the ignition key and the anti-theft alarm system is activated.

ⓘ CAUTION

For technical reasons, trailers fitted with rear LED lights are not integrated in the anti-theft alarm system.

Driving tips

Driving with a trailer always requires extra care.

Weight distribution

The weight distribution of a loaded trailer with an unladen vehicle is very unfavourable. However, if this cannot be avoided, drive extra slowly to allow for the unbalanced weight distribution.

Speed

The stability of the vehicle and trailer is reduced with increasing speed. For this reason, it is advisable not to drive at the maximum permissible speed in an unfavourable road, weather or wind conditions. This applies especially when driving downhill.

You should always reduce speed immediately if the trailer shows the slightest sign of **snaking**. Never try to stop the “snaking” by increasing speed.

Always brake in due course. If the trailer has an **overrun brake**, apply the brakes *gently at first* and then, firmly. This will prevent the jerking that can be caused by locking of trailer wheels. Select a low gear in due course before going down a steep downhill. This enables you to use the engine braking to slow down the vehicle.

Reheating

At very high temperatures and during prolonged slopes, driving in a low gear and high engine speed, always monitor the coolant temperature gauge » page 120.

Electronic Stability Control*

The ESC* system helps to stabilise the trailer in case of skidding or rocking.

Retrofitting a towing bracket*

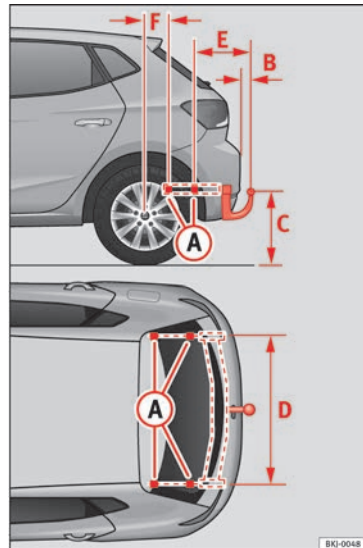

Fig. 226 Attachment points for towing bracket.

If a towing bracket is to be fitted after the vehicle is purchased, this must be completed according to the instructions of the towing bracket manufacturer.

The attachment points for the towing bracket **(A)** are on the lower part of the vehicle.

The distance between the centre of the ball coupling and the ground should never be lower than the indicated value, even with a fully loaded vehicle and including the maximum drawbar load.

Elevation values for securing the towing bracket:

Elevation values for securing the towing bracket:

(B)	65 mm (minimum)
(C)	350 mm to 420 mm (fully laden vehicle)
(D)	1,033 mm
(E)	322 mm
(F)	338 mm

Fitting a towing bracket

- Driving with a trailer involves an extra effort for the vehicle. Therefore, before fitting a towing bracket, please contact a Technical Service to check whether your cooling system needs modification.
- The legal requirements in your country must be observed (e.g. the fitting of a separate control lamp).

- Certain vehicle components, e.g. the rear bumper, must be removed and reinstalled. The towing bracket securing bolts must be tightened using a torque wrench, and a power socket must be connected to the vehicle electrical system. This requires specialised knowledge and tools.

- Figures in the illustration show the elevation value and the attachment points which must be considered if you are retrofitting a towing bracket.

**not recommended for some sportier versions.
Please consult your Technical Service.**

WARNING

The towing brackets should be fitted at a specialised workshop.

- If the towing bracket is incorrectly installed, there is a serious danger of accident.
- For your own safety, please observe the tow bracket manufacturer's instructions.

CAUTION

- If the power socket is incorrectly installed, this could cause damage to the vehicle electrical system.

Note

- SEAT recommends that the towing hooks be fitted at a specialised workshop. Consult your SEAT dealer in case additional modifications to your vehicle are necessary.
- Due to the specific design of the exhaust, the fitting of a conventional towing hook is

Advice

Care and maintenance

Accessories and modifications to the vehicle

Accessories, replacement of parts and modifications

Your vehicle is designed to offer a high standard of active and passive safety.

Before purchasing accessories and parts, and before making technical changes to your vehicle, we recommend that you consult your Technical Service.

SEAT dealerships will be happy to provide you with the latest information about the use, legal requirements and recommendations from the manufacturer regarding accessories and spare parts.

We recommend you use only **SEAT Approved Accessories®** and **SEAT Approved Spare Parts®**. This way, SEAT can guarantee that the product in question is suitable, reliable and safe. SEAT Technical Services have the necessary experience and facilities to ensure that parts are correctly and professionally installed.

Despite a continuous observation of the market, SEAT is not able to assess the reliability, safety and suitability of parts that **SEAT has not approved**. For this reason, SEAT cannot assume responsibility for any non-genuine parts used, even if these parts have been approved by an official testing agency or are covered by an official approval certificate.

Any **retro-fitted equipment** which has a direct impact on the driver's control of the vehicle, such as a cruise control system or electronically-controlled suspension, must be approved by SEAT for use in your vehicle and bear the **e** mark (the European Union's authorisation symbol).

If **any additional electrical devices** are fitted which do not serve to control the vehicle itself, such as refrigerator boxes, laptops or ventilator fans, they must bear the **CE** mark (European Union manufacturer conformity declaration).

WARNING

Accessories, for example telephone holders or cup holders, should never be fitted on the covers, or within the working range, of the airbags. Otherwise, there is a danger of injury if the airbag is triggered in an accident.

Technical modifications

Modifications must always be carried out according to our specifications. Unauthorised modifications to the electronic components or software in the vehicle may cause malfunctions. Due to the way the electronic components are linked together in networks, other indirect systems may be affected by the faults. This can seriously impair safety, lead to excessive wear of components, and also invalidate your vehicle registration documents.

SEAT Technical Services cannot be held liable for any damage caused by modifications and/or work incorrectly performed. For this reason, we recommend having all work performed by a SEAT Technical Service using **SEAT®** Original Spare Parts.

WARNING

Any type of work or modification performed incorrectly on your vehicle can lead to malfunctions and can cause accidents.

Radio transmitters and office equipment

Radio transmitters (fixed installation)

Any retrofit installations of radio transmitters in the vehicle require prior approval. SEAT generally authorises in-vehicle installations **»**

of approved types of radio transmitters provided that:

- The aerial is installed correctly.
- The aerial is installed on the exterior of the vehicle (and shielded cables are used together with non-reflective aerial trimming).
- The effective transmitting power does not exceed 10 Watts at the aerial base.

A SEAT Official Service and specialised workshop will be able to inform you about options for installing and operating radio transmitters with a *higher* transmitting power.

Mobile radio transmitters

Commercial mobile telephones or radio equipment might interfere with the electronics of your vehicle and cause malfunctions. This may be due to:

- No external aerial.
- External aerial incorrectly installed.
- Transmitting power more than 10 W.

You must, therefore, do not operate portable mobile telephones or radio equipment *inside the vehicle* without a properly installed external aerial »» » ⚠.

Please note also that the maximum range of the equipment can only be achieved with an *external* aerial.

Business equipment

Retrofit installation of business or private equipment in the vehicle is permitted, provided the equipment cannot interfere with the driver's immediate control of the vehicle and that any such equipment carries the C€ mark. Any retrofit equipment that could influence the driver's control of the vehicle must have a type approval for your vehicle and must carry the e mark.

⚠ WARNING

Mobile telephones or radio equipment which is operated inside the vehicle without a properly installed external aerial can create excessive magnetic fields that could cause a health hazard.

i Note

- **The posterior fitting of electric and electronic equipment in this vehicle affects its licence and could lead to the withdrawal of the vehicle registration document under certain circumstances.**
- **Please use the mobile telephone/radio operating instructions.**

Care and cleaning Taking care of your vehicle

General notes

Vehicle maintenance

Regular care and washing help to **maintain the value** of the vehicle. This may also be one of the requirements for acknowledging warranty claims in the event of bodywork corrosion or paint defects.

The best way to protect your vehicle against the harmful effects of the environment is through correct maintenance and *frequent* washing. The longer substances such as insect remains, bird droppings, resinous tree sap, road dirt, industrial deposits, tar, soot or road salt and other aggressive materials remain on the vehicle, the more damage they do to the paintwork. High temperatures, for instance in strong sunlight, further intensify the corrosive effect.

After winter, a period when salt is put on the roads, it is important to have the **underside** of the vehicle washed thoroughly.

Products for vehicle maintenance

Car-care products are available in your Technical Services. Keep the product instructions until you have used them up.

⚠ WARNING

- Car-care products can be toxic. Because of this, they must always be kept closed in their original container. Keep them out of the reach of children. Failure to comply could result in poisoning.
- Always read and observe the instructions and warnings on the package before using car-care products. Improper use could cause health problems or damage the vehicle. The use of certain products may produce noxious vapours; they should be used in well ventilated areas.
- Never use fuel, turpentine, engine oil, nail varnish remover or other volatile fluids. These are toxic and highly flammable. Risk of fire and explosion.
- Before washing your vehicle, or carrying out any maintenance, switch the engine off, apply the handbrake firmly and remove the key from the ignition.

ⓘ CAUTION

Never attempt to remove dirt, mud or dust if the surface of the vehicle is dry. Never use a dry cloth or sponge for cleaning purposes. This could damage the paintwork or the windows of your vehicle. Soak dirt, mud or dust with plenty of water.

♻ For the sake of the environment

- When purchasing car care products, try to select ones that are not harmful to the environment.
- The waste from car-care products should not be disposed of with ordinary household waste. Observe the disposal information on the package.

Care of the vehicle exterior**Automatic car wash tunnel**

The vehicle paintwork is so durable that the vehicle can normally be washed without problems in an automatic car wash tunnel. However, the paintwork wear depends to a large extent on the kind of the car wash tunnel, the brushes used, its water filtering and the type of cleaning and preservative products.

Before going through a car wash, be sure to take the usual precautions (close the windows, the roof and rear-view mirrors). There is nothing to note apart from that.

If the vehicle has special accessories such as spoilers or a roof rack or two-way radio aerial, etc., it is advisable to consult the car wash tunnel operator first.

After washing, **the brakes** could take some time to respond as the brake discs and pads could be wet, or even frozen in winter. "Dry" the brakes by braking several times.

⚠ WARNING

Water, ice and salt on the brake system can reduce braking effectiveness. Risk of accident.

Hand-washing**Vehicle washing**

- First soften the dirt and rinse it off with water.
- Clean your vehicle from top to bottom with a soft sponge, a glove or a brush. Use very light pressure.
- Rinse the sponge or glove often with clean water.
- Special car shampoo should only be used for very stubborn dirt.
- Leave the wheels, sill panels etc. until last, using a different sponge or glove.
- Rinse the vehicle thoroughly with water.
- Dry the vehicle surface gently with a chamois leather.
- In **cold temperature**, dry the rubber seals and their surfaces to prevent them from



freezing. Apply silicone spray to the rubber seals.

After washing the vehicle

- After washing, avoid sudden and sharp braking. “Dry” the brakes by braking several times.

WARNING

- Wash your vehicle with the ignition switched off.
- Protect your hands and arms from cuts on sharp metal edges when cleaning the underbody, the inside of the wheel housings etc. Risk of injury.
- Water, ice and salt on the brake system can reduce braking effectiveness. Risk of accident.

CAUTION

- Never remove dirt, mud or dust if the vehicle surface is dry. Never use a dry cloth or sponge for cleaning purposes. This could scratch the paintwork or glass on your vehicle.
- Washing the vehicle in low temperatures: when washing the vehicle with a hose, do not direct water into the lock cylinders or the gaps around the doors, rear lid, or sunroof. Risk of freezing.

For the sake of the environment

To protect the environment, the vehicle should be washed only in specially provided wash bays, to prevent toxic, oil-laden waste water from entering the sewer system. In some places, washing vehicles outside wash bays is prohibited.

Note

Do not wash the vehicle in direct sunlight.

Washing the vehicle with a high pressure cleaner

Be particularly careful when using a high pressure cleaner!

- Always observe the instructions for the high-pressure cleaner, particularly those concerning the **pressure** and the **spraying distance**.
- Increase the spraying distance for soft materials and painted bumpers.
- Do not use a high pressure cleaner to remove ice or snow from windows
»» page 251.
- Never use concentrated jet nozzles (“rotating jets”) »» .

- After washing, avoid sudden and sharp braking. “Dry” the brakes by braking several times »» page 181.

WARNING

- Never wash tyres with a concentrated jet (“rotating nozzle”). Even at large spraying distances and short cleaning times, damage can occur to the tyres. This may cause an accident.
- Water, ice and salt on the brake system can reduce braking effectiveness. Risk of accident.

CAUTION

- Do not use water hotter than +60°C (+140°F). This could damage the vehicle.
- To avoid damage to the vehicle, keep a sufficient distance from sensitive materials such as flexible hoses, plastic, soundproofing material, etc. This also applies to bumpers painted in the colour of the bodywork. The closer the nozzle is to the surface, the greater the wear on the material.

Factory-fitted adhesive sheets

The following indications should be taken into account to avoid damaging adhesive sheets:

- Do not use high pressure cleaners.

- Do not use scrapers to remove ice or snow from the sheets.
- Do not polish the adhesive sheets.
- Do not use dirty cloths or sponges.
- It is preferable to wash them with a soft sponge and gentle neutral soap.

Camera sensors and lenses

- Use a small brush to remove snow and a de-icer spray to remove ice.
- Clean the sensors with a solvent-free product and a soft, dry cloth.
- Moisten the camera lens using a standard alcohol-based glass cleaning agent and clean the lens with a dry cloth.

ⓘ CAUTION

- **When you clean the vehicle with a pressure washer:**
 - Stay a suitable distance from the sensors on the front and rear bumpers.
 - Do not clean the camera lenses or surrounding area with the pressure washer.
- **Never use warm or hot water to remove snow and ice from the reverse camera lens, as it could crack the lens.**
- **Never use abrasive cleaning agents on the lens.**

Vehicle paint maintenance

Regular waxing protects the paintwork.

You need to apply wax to your vehicle if water does not form small drops and run off the paintwork when it is *clean*.

Good quality *hard wax products* are available at your Technical Service.

Regular wax applications help to protect the paintwork from environmental contaminants » page 248. It is also effective in protecting against minor scratches.

Even if a **wax solution** is used regularly in the vehicle washing tunnel, it is advisable to protect the paint with a hard wax coating at least twice a year.

Polishing the paintwork

Polishing is only necessary if the paint has lost its shine, and the gloss cannot be brought back by applying wax. Polishing products can be purchased in your Technical Service.

The vehicle must be waxed after polishing if the polish used does not contain wax compounds to seal the paint » page 251, **Vehicle paint maintenance**.

ⓘ CAUTION

To prevent damage to the paintwork:

- **Do not use polishes and hard wax on painted parts with a matt finish or on plastic parts.**
- **Do not polish your vehicle in a sandy or dusty environment.**

Caring for plastic parts

If normal washing fails to clean plastic parts, clean them with approved **solvent-free** plastic cleaning and care products.

ⓘ CAUTION

- **The use of liquid air freshener directly over the air vents of the vehicle may damage the plastic parts if the liquid is accidentally spilled.**
- **Cleaning products which contain solvents will damage the material.**

Cleaning of windows and mirrors

Cleaning windows

- Moisten the windows with commercially available, alcohol based glass cleaner.
- Dry the windows with a clean chamois leather or a lint-free cloth.

»

Removing snow

- Use a small brush to remove snow from the windows and mirrors.

Removing ice

- Use a de-icer spray.

Use a clean cloth or chamois leather to dry the windows. The chamois leathers used on painted surfaces are not suitable to clean windows because they are soiled with wax deposits which could smear the windows.

If possible, use a de-icing spray to remove ice. If you use an ice scraper, push it in one direction only without swinging it.

Use window cleaner or a silicone remover to clean rubber, oil, grease and silicone deposits off.

Wax deposits can only be removed with a special cleaner available at your Technical Service. Wax deposits on the windscreen could cause the wiper blades to judder. Adding a window cleaner that dissolves wax to the windscreen washer fluid reservoir prevents wiper blades from juddering, but the wax deposits are not removed.

ⓘ CAUTION

- **Never use warm or hot water to remove snow and ice from windows and mirrors. This could cause the glass to crack!**

- **The heating element for the rear window is located on the inner side of the window. To prevent damage, do not put stickers over the heating elements on the inside of the window.**

Cleaning windscreen wiper blades

Clean wiper blades improve visibility.

1. Use a soft cloth to remove dust and dirt from the windscreen wiper blades.
2. Use window cleaner to clean the windscreen wiper blades. Use a sponge or a cloth to remove stubborn dirt.

Care of rubber seals

If rubber seals are well looked after, they will not freeze so quickly.

1. Use a soft cloth to remove dust and dirt from the rubber seals.
2. Apply a specialist care product to the rubber seals.

The rubber strips on the doors, windows, etc. will remain pliable and last longer if they are treated with a suitable rubber care product from time to time (for example silicone spray).

Caring for rubber seals will also prevent premature ageing and leaks. The doors will be easier to open. If rubber seals are well looked after, they will not freeze so quickly in winter.

Door lock cylinder

The door lock cylinders can freeze up in winter.

To de-ice the lock cylinders you should only use spray with lubricating and anti-corrosive properties.

Cleaning chrome parts

1. Clean chrome parts with a damp cloth.
2. Polish chrome parts with a soft, dry cloth.

If this does not provide satisfying results, use a specialist **chrome cleaning product**. Chrome cleaning products will remove stains from the surface.

ⓘ CAUTION

To prevent scratching chrome surfaces:

- **Never use an abrasive cleaning product on chrome.**
- **Do not clean or polish chrome parts in a sandy or dusty environment.**

Steel wheel rims

- Clean steel wheel rims regularly using a separate sponge.

Use an industrial cleaner to remove brake dust. Any damage to the paint on steel wheel rims should be repaired before starting to rust.

WARNING

- Never wash tyres with a cylindrical jet. Even at large spraying distances and short cleaning times, damage can occur to the tyres. This may cause an accident.
- Water, ice and salt on the brake system can reduce braking effectiveness. Risk of accident. Directly after washing, avoid sudden and sharp braking. "Dry" the brakes by braking several times » page 181, Braking capacity and braking distance.

Alloy wheel rims

Every two weeks

- Wash salt and brake dust from alloy wheels.
- Use an acid free detergent to clean the wheel rims.

Every 3 months

- Apply a hard wax compound to the wheels.

Alloy wheels require regular attention to preserve their appearance. If road salt and brake dust are not often removed, the aluminium finish will be impaired.

Always use an acid-free detergent for alloy wheel rims.

Car polish or other abrasive agents should not be used for maintaining the rims. If the protective coating is damaged, e.g. by flying stones, the damaged area should be repaired immediately.

WARNING

Observe the safety warnings »  in Steel wheel rims on page 253.

Vehicle underbody protection

The vehicle underbody is coated to protect it from chemical and mechanical damage.

The protective coating can be damaged when driving. We recommend that you check the protective coating under the body and on the running gear, and retouch it if necessary, before and after the winter season.

We recommend that you go to your Technical Service to carry out repair work and additional anti-corrosion work.

WARNING

Do not apply underseal or anti-corrosion coatings to the exhaust pipes, catalytic converter or the heat shields on the exhaust system. The heat of the exhaust system or the engine could cause them to ignite. Risk of fire.

Cleaning engine compartment

Take special care when cleaning the engine compartment.

Anti-corrosion treatment

The engine compartment and the surface of the power unit are given anti-corrosion treatment at the factory.

Good corrosion protection is particularly important in winter when the vehicle is frequently driven on salted roads. To prevent the salt corroding the vehicle, the entire engine compartment should be thoroughly cleaned before and after winter.

Technical Services have the proper products for cleaning and preservation as well as the necessary workshop equipment. For this reason, we recommend having this work performed by them.

The anti-corrosion protection is usually removed if the engine compartment is cleaned with grease removing solutions, or if you »

have the engine cleaned. On commissioning this work, ensure that all surfaces, seams, joints and components in the engine compartment are given anti-corrosion treatment.

WARNING

- When working in the engine compartment, always observe the safety warnings »» page 263.
- Before opening the bonnet, switch the engine off, apply the handbrake firmly and always remove the key from the ignition.
- Allow the engine to cool before you clean the engine compartment.
- Do not clean, for example, the vehicle underbody, wheel arches or wheel trims without protecting your hands and arms. You may cut yourself on sharp-edged metal parts. Failure to comply could result in injury.
- Moisture, ice and salt on the brake system may affect braking effectiveness. Risk of accident. Directly after washing, avoid sudden and sharp braking.
- Never touch the radiator fan. It is temperature-controlled and could start automatically, even when the key is removed from the ignition!

For the sake of the environment

Fuel, grease and oil deposits can be removed when the engine is washed. The polluted water must be cleaned in an oil separator. For this reason, engine washing should be car-

ried out only by a specialised workshop or a petrol station.

Caring for the vehicle interior

Screen for the radio/Easy Connect* and control panel*

The display can be cleaned with a soft cloth and a professionally available "LCD cleaner". Moisten the cloth with a small amount of the cleaning fluid.

The Easy Connect control panel* should first be cleaned with a brush so that no dirt goes into the device or between the keys and housing. Next, we recommend cleaning the Easy Connect control panel* using a cloth dampened with water and washing-up liquid.

CAUTION

- To avoid scratching the screen, do not wipe the display with a dry cloth.
- To avoid damage, ensure that no liquid goes into the Easy Connect control panel*.

Cleaning plastic parts and the dash panel

- Use a clean, damp cloth to clean plastic parts and the dash panel.

- If this does not provide satisfactory results, use a special **solvent-free** plastic cleaning product.

WARNING

Never clean the dash panel and the airbag module surface with cleaners containing solvents. Solvents cause the surface to become porous. If the airbag triggered, plastic parts could become detached and cause injuries.

CAUTION

Cleaning products which contain solvents will damage the material.

Cleaning wooden trim*

- Clean the wooden trim with a water-moistened clean cloth.
- If this does not provide satisfactory results, use a *gentle* soap solution.

CAUTION

Cleaning products which contain solvents will damage the material.

Cleaning textile covers and trim parts

Textile covers and trim parts (e.g. seats, door trim) should be cleaned regularly with a

vacuum cleaner. This will remove surface dirt which could otherwise be rubbed into the textile material during use. Do not use steam cleaners, as the steam could carry the dirt deeper into the textile material.

Normal cleaning

We recommend that you use a soft sponge or a commercially available lint-free, micro-fibre cloth for normal cleaning. Only use brushes on floor coverings and mats, as other textile surfaces could become damaged.

In the case of normal surface dirt you can use a foam cleaner. Use a sponge to spread the foam on the textile surface and to work it into the material lightly. However, make sure that the textile material does not become soaking wet. Then dab off the foam with a dry and absorbent cloth (e.g. a micro-fibre cloth) and vacuum off any residue once the surface is completely dry.

Cleaning stains

Treat drink stains (such as coffee or fruit juice, etc.) with a cleaning solution for delicate fabrics. This solution should be applied with a sponge. If the stains are difficult to remove, a washing paste can be applied directly onto the stain and worked into the fabric. The surface will then have to be wiped with clear water to remove any residue left by the paste. To do so, use a damp cloth or sponge

and then dab the stain with an absorbent cloth.

Remove chocolate or make-up stains with a cleaning paste (for e.g., soft soap). Then remove the soap with water (wet sponge).

A spirit-based cleaner can be used to remove grease, oil, lipstick or ball point pen. Then dab the dissolved grease or colour particles off with an absorbent cloth or similar. You may also have to treat the stain once more using washing paste and water.

If the covers or textile trim panels are badly soiled we recommend that you have them cleaned by a professional cleaning company with a shampoo and spray.

Note

Open Velcro fasteners on clothes can damage the seat upholstery. Make sure they are closed.

Cleaning leather*

Normal cleaning

- Moisten a cotton or woollen cloth with water and wipe over the leather surfaces.

Cleaning stubborn stains

- More stubborn dirt can be removed using a mild soap solution (pure liquid soap; two

tablespoons diluted in one litre of water) and a cloth.

- Do not let the water soak through the leather or soak into the seams.
- Then wipe off with a soft, dry cloth.

Leather maintenance

- The leather should be treated twice a year with a special leather-care product, available at Technical Services.
- Apply these products very sparingly.
- Then wipe off with a soft cloth.

SEAT does everything possible to preserve the genuine qualities of this natural product. Due to the natural properties of the specially selected hides employed, the finished leather has a certain sensitivity to grease and dirt, etc. so a degree of care is required in everyday use and when looking after the leather.

Dust and grit in the pores and seams can scratch and damage the surface. If the vehicle is under solar radiation for long periods, the leather should be protected to prevent it from fading. However, slight colour variations in high-quality natural leather are normal.

CAUTION

- **Do not use solvents, wax polish, shoe cream, spot removers or similar products on leather.**

- To avoid damage, stubborn stains should be removed by a specialised workshop.

Cleaning Alcantara upholstery*

Removing dust and dirt

- Moisten a cloth *just a little* and wipe down the seat covers.

Removing stains

- Moisten a cloth with lukewarm water or diluted **white spirits**.
- Dab at the stain. Start at the outside and work inwards.
- Dry the clean area with a soft cloth.

Do not use leather cleaning products on Alcantara seat covers.

You may use a suitable soap on dust and dirt.

Dust and grit in the pores and seams can scratch and damage the surface. If the car is left standing in the sun for long periods, Alcantara leather should be protected against direct sunlight to prevent it from fading. However, slight colour variations will arise in normal use.

ⓘ CAUTION

- Do not use solvents, wax polish, shoe cream, stain removers, leather cleaning products or any similar products on Alcantara.
- To avoid damage, stubborn stains should be removed by a specialised workshop.
- On no account use brushes, hard sponges or similar utensils.

Cleaning seat belts

A dirty belt may not work properly. Check all seat belts regularly and keep them clean.

Seat belts cleaning

- Pull the dirty seat belt right out and unroll it.
- Clean dirty seat belts with a *gentle* soap solution.
- Allow it to dry.
- Do not roll the seat belt up until it is dry.

If large stains form on the belts, the automatic belt retractor will not work correctly.

⚠ WARNING

- Do not use chemical cleaning agents on the seat belts, as this can impair the strength of the webbing. Ensure that seat belts do not come into contact with corrosive fluids.

- Check the condition of the seat belts at regular intervals. If you notice that the belt webbing, fittings, retractor mechanism or buckle of any of the belts is damaged, the belt must be replaced by a specialised workshop.
- Do not attempt to repair a damaged seat belt yourself. The seat belts must not be removed or modified in any way.

ⓘ CAUTION

After cleaning, allow seat belts to dry completely before rolling them up. Otherwise, the belt retractors could become damaged.

Checking and refilling levels

Refuelling

Refuelling

Read the additional information carefully

»  page 57

If the automatic filler nozzle is operated correctly, it will switch itself off as soon as the tank is “full”. Never attempt to fill beyond this point, as this will fill the expansion chamber. Fuel may leak out if ambient conditions are warm.

The correct fuel grade for your vehicle is given on a sticker on the inside of the fuel tank flap.

Vehicles with natural gas engines and hybrids

Every 6 months it is necessary to run on petrol until the control lamp switches off  and then the tank must be refilled. This is necessary to ensure that the system works properly, as well as the fuel quality required for driving with petrol.

WARNING

- Fuel is highly flammable and can cause serious burns and other injuries.

- Never smoke or come into contact with sparks when filling the fuel tank of the vehicle or a spare fuel canister with fuel. This is an explosion hazard.

- Follow legal requirements for the use of spare fuel canisters.

- For safety reasons we do not recommend carrying a spare fuel canister in the vehicle. The canister could be damaged in an accident and leak.

- If, in exceptional circumstances, you have to carry a spare fuel canister, please observe the following:

- Never fill the spare fuel canister inside the vehicle or on it. An electrostatic charge could build up during filling, causing the fuel fumes to ignite. This could cause an explosion. Always place the canister on the ground to fill it.

- Insert the fuel nozzle into the mouth of the canister as far as possible.

- If the spare fuel canister is made of metal, the filling nozzle must be in contact with the canister during filling. This helps prevent an electrostatic charge building up.

- Never spill fuel in the vehicle or in the luggage compartment. Fuel vapours are explosive. Danger of death.

CAUTION

- Fuel spills should be removed from the paintwork immediately.

- Never run the tank completely dry. Irregular fuel supply can cause misfiring. As a result, unburnt fuel could enter the catalytic converter and cause damage.

- When filling the fuel tank after having run it completely dry on a vehicle with a diesel engine the ignition must be switched on for at least 30 seconds before starting the engine. Subsequently, when you start the engine it may take longer than normal to start firing (up to one minute). This is due to the fact that the fuel system has to purge itself of air before starting.

For the sake of the environment

Do not try to put in more fuel after the automatic filler nozzle has switched off, this may cause the fuel to overflow if it becomes warm.

Note

There is no emergency mechanism for the manual release of the fuel tank flap. If necessary, request assistance from specialised personnel.

Refuelling with natural gas

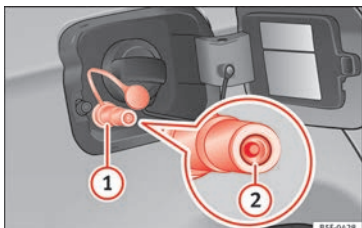

Fig. 227 Tank flap open: gas filler mouth ①, filler mouth retainer ②

Before refuelling, the engine and the ignition, mobile telephone and heating must be switched off separately » » » ⚠.

Read the instructions on how to use the natural gas pump carefully.

The vehicle is not prepared for refuelling with liquefied natural gas (LNG) » » » ⚠. Before refuelling with natural gas, make sure you add the appropriate type of fuel » » » page 258.

Opening the fuel tank cap

The natural gas filler mouth is behind the fuel tank cap, next to the petrol filler mouth.

- Unlock the vehicle with the key or with the central locking button situated on the driver door » » » page 134.

- Press on the rear area of the flap and open it.

Refuelling

Special feature: if the ambient temperature is very high, the natural gas pump protection against overheating disconnects this automatically.

- Remove the plug from the gas filler mouth » » » Fig. 227 ①.
- Connect the pump filling nozzle to the gas filler mouth.
- The fuel tank will be *full* when the pump compressor automatically cuts the supply.
- If you wish to finish refuelling in advance, press the button on the pump to stop the flow.

Closing the fuel tank cap

- Check that the gas filler mouth retainer ② is not trapped with the filler nozzle. If necessary, place it in the filler mouth again.
- Insert the plug in the filler mouth.
- Close the tank flap. Make sure you hear it click into place.

⚠ WARNING

Natural gas is a highly explosive, easily flammable substance. Incorrect handling of the natural gas can cause accidents serious burns and other injuries.

- **Before refuelling with natural gas, engage the filling mouth correctly. If you can smell gas, stop refuelling immediately.**

⚠ WARNING

The vehicle is not prepared to use liquefied natural gas (LNG), and this fuel must not be added under any circumstances. Liquefied natural gas can cause the natural gas tank to explode, resulting in serious injury.

Note

- **The filling nozzles of natural gas pumps can differ in the way they are operated. If you do not know, ask a qualified employee at the petrol station to do the refuelling.**
- **Noises heard when refuelling are normal and do not indicate the presence of a fault in the system.**
- **The vehicle natural gas system is prepared both for refuelling with a small compressor (slow refuel) and a large compressor (fast refuel) in natural gas service stations.**

Fuel

Types of petrol

The correct grade of petrol is listed inside the fuel tank flap.

The vehicle is equipped with a catalytic converter and must only be run on **unleaded petrol**. The petrol must comply with European Standard EN 228 or German standard DIN 51626-1 and must be **unleaded**. You can refuel with a maximum ethanol proportion of 10 % (E10). The types of petrol are differentiated by their **octane rating (RON)**.

The following titles appear on the corresponding adhesive on the fuel tank flap:

Super unleaded 95 octane or normal 91 octane unleaded petrol

We recommend you use super 95 octane petrol. If this is not available: normal 91 octane petrol, with a slight decrease in power.

Super unleaded petrol with a minimum of 95 octanes

You should use super petrol with a minimum of 95 octanes.

If super is not available, *in an emergency* you may refuel with normal 91 octane petrol. In this case only use moderate engine speeds and a light throttle. Refuel with super as soon as possible.

Super unleaded 98 octane or super 95 octane unleaded petrol

We recommend you use super plus 98 octane petrol. If this is not available: super 95 octane petrol, with a slight decrease in power.

If super is not available, *in an emergency* you may refuel with normal 91 octane petrol. In this case only use moderate engine speeds and a light throttle. Refuel with super as soon as possible.

Petrol additives

The quality of the fuel influences the behaviour, power and service life of the engine. This is why the petrol you use should carry suitable additives already included by the petrol industry, free of metals. These additives will help to prevent corrosion, keep the fuel system clean and prevent deposits from building up in the engine.

If good-quality petrol with metal-free additives is not available or engine problems arise, the necessary additives must be added when refuelling » ①.

Not all petrol additives have been shown to be effective. The use of unsuitable petrol additives may cause significant damage to the engine and the catalytic converter. Metal additives should never be used. Metal additives may also be contained in petrol additives for improving anti-detonation ratings or octane ratings » ①.

SEAT recommends “genuine Volkswagen Group Fuel Additives for petrol engines”. These additives can be bought at SEAT dealers, where information on how to use them can also be obtained.

ⓘ CAUTION

- Do not refuel if the filler indicates that the fuel contains metal. LRP (*lead replacement petrol*) fuels contain high concentrations of metal additives. Using them may damage the engine!
- Never refuel with fuels containing a large proportion of ethanol (for example, E50, E85). This could damage the fuel system.
- Just filling one full tank of leaded fuel or fuel containing other metal additives would seriously impair the efficiency of the catalytic converter.
- Only use fuel additives that have been approved by SEAT. Octane boosting or anti-knock additives may contain metal additives that could seriously damage the engine or the catalytic converter. These additives must not be used.
- High engine speed and full throttle can damage the engine when using petrol with an octane rating lower than the correct grade for the engine.

ⓘ Note

- You may use petrol with a high octane number than the one recommended for your engine.
- In those countries where unleaded petrol is not available, you may refuel with a fuel with a low lead content.

Diesel fuel

Please note the information on the inside of the fuel tank flap.

We recommend the use of **diesel** fuel which complies to European standard EN 590. If diesel fuel which meets European standard EN 590 is not available, the Cetane number (CZ) must, at minimum, be 51. If the engine is equipped with a particulate filter, the sulphur content of the fuel must be below 50 parts per million.

Winter-grade diesel

Summer fuel becomes thicker in winter and it is more difficult to start the engine. For this reason, petrol stations in some countries also offer winter diesel with improved fluidity when cold (winter-grade diesel).

ⓘ CAUTION

- **The vehicle is not designed for the use of FAME fuel (biodiesel). The fuel system would be damaged if you used biodiesel.**
- **Do not mix fuel additives, the so-called "thinners", petrol or similar additives with diesel fuel.**
- **If poor-quality diesel fuel is used, it may be necessary to drain the fuel filter more frequently than is specified in the Maintenance Programme. We recommend having this done by a specialised workshop. If water is allowed**

to collect in the filter, this can cause engine performance problems.

Natural gas

Natural gas can be compressed or in liquid form, addition to others.

Liquefied natural gas (LNG) is the result of heavy cooling of natural gas. Therefore its volume is considerably reduced compared with compressed natural gas (CNG). In vehicles with a natural gas engine, liquefied natural gas cannot be directly refilled, as the gas would expand excessively in the vehicle gas tank.

Therefore, vehicles with a natural gas engine must only be refuelled using compressed natural gas » » ⚠.

Natural gas quality and consumption

Natural gas is divided into the groups H and L depending on its quality.

Gas type H has a superior heating power and inferior nitrogen and carbon dioxide content than type L. The higher the heating power of the natural gas, the lower the consumption will be.

However, the heating power and the proportion of nitrogen and carbon dioxide can fluctuate within the quality groups. Therefore, ve-

hicle consumption can also vary when using a single type of gas only.

The engine management automatically adapts to the natural gas used according to its quality. Therefore, different quality gases can be mixed in the tank, without the need for comprehensive draining before applying a different quality gas.

Updated information relating to natural gas quality is displayed on the instrument panel » » 📖 page 37.

Natural gas and safety

If you can smell gas or suspect that there is a leak » » ⚠:

- Stop the vehicle immediately.
- Switch the ignition off.
- Open the doors to appropriately ventilate the vehicle.
- Extinguish cigarettes immediately.
- Move away from the vehicle or switch off objects that may cause sparks or a fire.
- If you continue to smell gas, do not continue driving!
- Seek specialist assistance. Have the fault repaired.

Regular checks of the natural gas system

The natural gas tanks may be damaged or corroded by external factors. The walls of the

gas tanks are weakened by deformations, damage or corrosion. As a result, the tanks could burst and result in serious injuries or even death. For this reason, the vehicle owner must have a specialised workshop check (visual check) **the gas system every 4 years at least**. The vehicle owner must have a specialised workshop replace the natural gas tanks before they reach the end of their service life. For further information about the service life of gas tanks, go to a SEAT dealer service or a specialised workshop

WARNING

Failure to act when you can smell gas in the vehicle or when refuelling can cause serious injuries.

- Carry out the necessary operations.
- Leave the danger zone.
- If necessary, warn the emergency services.

WARNING

The vehicle is not prepared to use liquefied natural gas (LNG) and this fuel must not be added under any circumstances. Liquefied natural gas can cause the natural gas tank to explode, resulting in serious injury.

WARNING

Damaged, corroded or rusted tanks can result in serious injury or even death.

- Have the natural gas deposits checked at least every 4 years (visual check).
- Natural gas tanks have a limited service life. Have the natural gas tanks replaced when required. You can obtain further information about this at SEAT dealers or specialised workshops.

WARNING

If the vehicle underbody touches the ground or in the event of a rear collision, there could be damage to the natural gas tanks.

- Check whether there is a smell of gas.
- If you notice a smell of gas, take the vehicle to a specialised workshop immediately and have the natural gas system checked.

Note

Have the natural gas system checked regularly by a specialised workshop, according to the Maintenance Programme.

AdBlue®

Information on AdBlue®

The consumption of AdBlue® depends on your personal driving style, the temperature of the system and on the outdoor temperature when the vehicle is used.

AdBlue® freezes at temperatures of -11°C (+13°F). The system has heating elements that guarantee its operation even at low temperatures.

The AdBlue® tank level capacity is approximately 10.4 litres.

The AdBlue® tank should never be empty. When the distance to empty drops below 2400 km, a warning to refill the AdBlue® tank will appear on the dash panel display **»» page 262**. If this information is ignored, later on it will not be possible to re-start the engine. If this warning does not appear, it is not necessary to refill the AdBlue® tank.

AdBlue® is a registered brand of the German Association of the Automotive Industry (VDA) and is also known as AUS32 or DEF (Diesel Exhaust Fluid).

CAUTION

Filling the AdBlue® tank excessively can cause damage to the tank.

Refilling AdBlue®

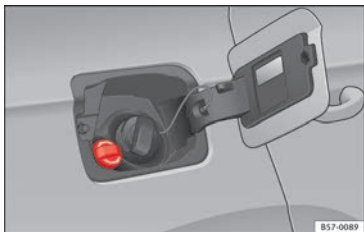

Fig. 228 AdBlue tank cap.

Operations prior to refilling

Park the vehicle on a flat surface. If the vehicle is not parked on a flat surface, but, for example, on a slope or on the side of a curb, the level indicator may not detect the load properly.

If a warning message about AdBlue® levels appears on the dash panel display, **fill at least the minimum amount required (approx. 5 litres)**. Only after adding this amount will the system detect that AdBlue® has been added and you will be able to start the engine again. The maximum amount that can be refilled is 11 litres.

Switch the ignition off. If the ignition is not switched off during refilling, the warning to refill may continue to appear on the instrument panel display.

Fill with a refill bottle

Only use AdBlue® that complies with ISO 22241-1. Only use original containers.

- Open the tank cover » Fig. 228.
- Unscrew the tank cap by turning it in an anti-clockwise direction.
- Please observe the manufacturer's instructions, indicated on the refill bottle.
- Check the expiry date.
- Remove the cap of the refill bottle.
- Insert the neck of the bottle in the tank filler neck vertically and screw the bottle on by hand, by turning it in a clockwise direction.
- Press the refill bottle in the direction of the filler neck and hold it in this position.
- Wait until the contents of the refill bottle have been poured into the AdBlue® tank. Do not compress or break the bottle!
- Turn the bottle in a counter-clockwise direction and gently pull it upwards » !.
- The AdBlue® tank is full when no more liquid comes out of the bottle.
- Screw on the tank cap in a clockwise direction until it is tightly closed.
- Close the fuel tank flap.

Operations before driving

- After refilling the tank, **only** switch on the ignition.

- Leave the ignition on for at least 30 seconds for the system to detect the fluid load.
- Make sure you wait for at least 30 seconds before starting the engine!

Refilling the dispenser with AdBlue

Valid for vehicles with selective catalytic reduction.

- Open the tank cap.
- Turn the SCR tank cap anti-clockwise » Fig. 228.
- Add AdBlue until the nozzle stops for the first time.
- Close the SCR tube by turning it clockwise until you hear a click.

⚠ WARNING

AdBlue® should only be stored in the original container, which should be tightly closed and kept in a safe place.

- **Never keep AdBlue® in empty food containers, bottles or other similar containers. Other people may confuse it for other products.**
- **Keep AdBlue® out of the reach of children.**

ⓘ CAUTION

When refilling, the nozzle grip should be aligned downward. Otherwise the nozzle will not connect automatically.

- Do not try to add any more additive after the nozzle has stopped for the first time. The AdBlue tank could overflow and AdBlue could spill out.
- Only use AdBlue® that complies with ISO 22241-1. Only use original containers.
- Never mix AdBlue® with water, fuel or additives. Any type of damage caused by such a mixture will not be covered by the warranty.
- Never pour AdBlue® into the fuel tank. This could result in engine damage.
- Do not carry the refill bottle inside the vehicle. If there is a leak (due to temperature changes or damage to the bottle), the AdBlue® may damage the vehicle.

For the sake of the environment

Dispose of the refill bottle in an environment-friendly manner.

Note

You can buy refill bottles that are adequate for AdBlue® use at SEAT dealerships.

Working in the engine compartment

Safety notes for work in the engine compartment

Read the additional information carefully
»  page 17

Before starting any work on the engine or in the engine compartment:

1. Switch off the engine and remove the key from the ignition.
2. Apply the handbrake.
3. Move the gear lever to neutral or the selector lever to position P.
4. Wait for the engine to cool down.
5. Keep children away from the vehicle.
6. Raise the bonnet » page 264.

You should not do any work in the engine compartment unless you know exactly how to carry out the jobs and have the correct tools! Have the work carried out by a specialised workshop if you are uncertain.

All service fluids and consumables, e.g. coolant, engine oil, spark plugs and batteries, are under constant development. SEAT provides a constant flow of information to Technical Services concerning modifications. For this reason, we recommend you have service

fluids and consumables replaced by a Technical Service. Please observe the relevant instructions » page 247. The engine compartment of the vehicle is a hazardous area » .

WARNING

All work on the engine or in the engine compartment, e.g. checking and refilling fluids, involves the danger of injury and burns, accidents and even fire.

- Never open the bonnet if you see steam, smoke or coolant escaping from the engine compartment. Otherwise, there is a risk of sustaining burns. Wait until no more steam or coolant is emitted, then allow the engine to cool before carefully opening the bonnet.
- Switch off the engine and remove the key from the ignition.
- Apply the handbrake and move the gear lever to neutral or selector lever to position P.
- Keep children away from the vehicle.
- Never touch hot engine parts. There is a risk of burns.
- Never spill liquids on a hot engine or on a hot exhaust gas system. This is a fire hazard.
- Avoid causing short-circuits in the electrical system, particularly at the points where the jump leads are attached »  page 72. The battery could explode.
- Never touch the radiator fan. It is temperature controlled and could start automatically, even when the engine has been switched off and the key removed from the ignition!

- Never cover the engine with additional insulating materials such as a blanket. Risk of fire!
- Do not unscrew the cap on the coolant expansion tank when the engine is hot. If the coolant is hot, the cooling system will be pressurised!
- Protect face, hands and arms by covering the cap with a large, thick cloth to protect against escaping coolant and steam.
- Always make sure you have not left any objects, such as cleaning cloths or tools, in the engine compartment.
- If you have to work underneath the vehicle, you must use suitable stands additionally to support the vehicle, there is a risk of accident!. A hydraulic jack is insufficient for securing the vehicle and there is a risk of injury.
- If any work has to be performed when the engine is started or with the engine running, there is an additional, potentially fatal, safety risk from the rotating parts, such as the drive belts, alternator, radiator fan, etc., and from the high-voltage ignition system. You should also observe the following:
 - Never touch the electrical wiring of the ignition system.
 - Ensure that jewellery, loose clothing and long hair do not get trapped in rotating engine parts. Danger of death. Before starting any work remove jewellery, tie back and cover hair, and wear tight-fitting clothes.

- Never accelerate with a gear engaged without taking the necessary precautions. The vehicle could move, even if the handbrake is applied. Danger of death.
- If work has to be carried out on the fuel system or on electrical components, you must observe the following safety notes in addition to the above warnings:
 - Always disconnect the battery from the on-board network. The vehicle must be unlocked when this is done, otherwise the alarm will be triggered.
 - Do not smoke.
 - Never work near naked flames.
 - Always have a fire extinguisher on hand.

WARNING

If the bonnet is not correctly closed, it could suddenly open while driving leaving the driver without visibility. This could result in a serious accident.

- After closing the bonnet, always check that it is properly secured by the locking mechanism in the lock carrier piece. The bonnet must be flush with the surrounding body panels.
- While driving, if you notice that the bonnet is not correctly closed then stop immediately and close it correctly.
- Only open and close the bonnet when there is nobody within its range.

CAUTION

When topping up service fluids, make sure not to mistake them. Using the wrong fluids could cause serious malfunctions and engine damage!

For the sake of the environment

Service fluids leaks are harmful to the environment. For this reason you should make regular checks on the ground underneath your vehicle. If you find spots of oil or other fluids, have your vehicle inspected in a specialised workshop.

Opening the bonnet

Read the additional information carefully
 page 17

The bonnet is released from inside the vehicle.

Before opening the bonnet ensure that the windscreen wipers are in rest position.

WARNING

Hot coolant can scald!

- Never open the bonnet if you see steam, smoke or coolant escaping from the engine compartment.

- Wait until no more steam, smoke or coolant is emitted from the bonnet, then carefully open the bonnet.
- When working in the engine compartment, always observe the safety warnings
»» page 263.

Closing the bonnet

- Slightly lift the bonnet.

- Release the bonnet stay and replace it in its support.
- At a height of approximately 30 cm let it fall so it locks.

If the bonnet does not close, do not press downwards. Open it again and let it fall as mentioned above.

WARNING

If the bonnet is not closed properly, it could open while you are driving and completely obscure your view of the road. Risk of accident.

- After closing the bonnet, always check that it is properly secured. The bonnet must be flush with the surrounding body panels.

- If you notice that the bonnet latch is not secured when the vehicle is moving, stop the vehicle immediately and close the bonnet properly. Risk of accident.

Checking levels

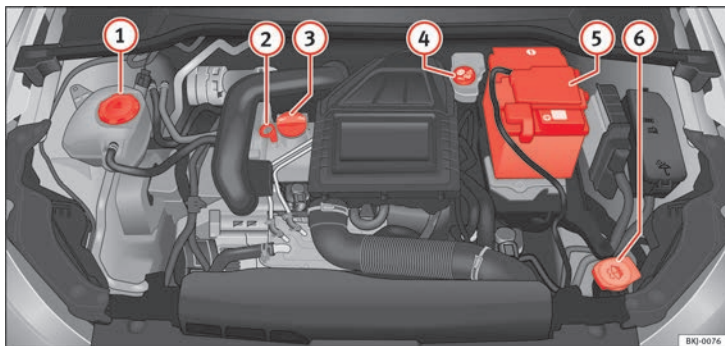

Fig. 229 Diagram for the location of the various elements.

From time to time, the levels of the different fluids in the vehicle must be checked. Never fill with incorrect fluids, otherwise serious damage to the engine may be caused.

- ① Coolant expansion tank
- ② Engine oil level dipstick
- ③ Engine oil filler cap
- ④ Brake fluid reservoir
- ⑤ Vehicle battery
- ⑥ Windscreen washer reservoir

The checking and refilling of service fluids are carried out on the components men-

tioned above. These operations are described in »» page 263.

Overview

You will find further explanations, instructions and restrictions on the technical specifications as of »» page 281.

Note

The layout of parts may vary depending on the engine.

Engine oil

General notes

The engine comes with a special, multi-grade oil that can be used all year round.

Because the use of high-quality oil is essential for the correct operation of the engine and its long useful life, when topping up or changing oil, use only those oils that comply with VW standards.

The specifications (VW standards) set out in the following page should appear on the container of the service oil; when the container displays the specific standards for petrol and

diesel engines together, it means that the oil can be used for both types of engines.

We recommend that the oil change indicated in the Maintenance Programme, be performed by a technical service or specialised workshop.

The correct oil specifications for your engine are listed in the  **page 59**.

Service intervals



Service intervals can be flexible (LongLife service) or fixed (dependent on time/distance travelled).

If the PR code that appears on the back of the Maintenance Programme booklet is PR Q16, this means that your vehicle has the LongLife service program. If it lists the codes Q11, Q12, Q13, Q14 or Q17, the interval service is dependent on the time/distance travelled.



Flexible service intervals (LongLife service intervals*)

Special oils and processes have been developed which, depending on the characteristics and individual driving profiles, enable the extension of the oil change service (LongLife service intervals).

Because this oil is essential for extending the service intervals, it **must only** be used observing the following indications:

- Avoid mixing it with oil for fixed service intervals.
- Only in exceptional circumstances, if the engine oil level is too low  **page 268** and LongLife oil is not available, it is permitted to top up (once) with oil for **fixed service intervals**  **page 59** (up to a maximum of 0.5 litres).

Fixed service intervals*

If your vehicle does not have the “LongLife service interval” or it has been disabled (by request), you may use oils for **fixed service intervals**, which also appear in  **page 59**. In this case, your vehicle must be serviced after a fixed interval of 1 year/15,000 km (10,000 miles) (whatever comes first)  **Booklet Maintenance Programme**.

- In exceptional circumstances, if the engine oil level is too low  **page 268** and you cannot obtain the oil specified for your vehicle, you can add a small quantity of oil conforming to the specification ACEA A2 or ACEA A3 (petrol engines) or ACEA B3 or ACEA B4 (diesel engines) (up to 0.5 l).

Vehicles with diesel particulate filter*

The Maintenance Programme states whether your vehicle is fitted with a diesel particulate filter.

Only VW 507 00 engine oil, with reduced ash formation, may be used in diesel engines equipped with particulate filter. Using other types of oil will cause a higher soot concentration and reduce the life of the DPF. Therefore:

- Avoid mixing this oil with other engine oils.
- Only in exceptional circumstances, if the engine oil level is too low  **page 268**, **Checking engine oil level** and you cannot obtain the oil specified for your vehicle, you can use a small quantity of oil (once) conforming to the VW 506 00, VW 506 01, VW 505 00, VW 505 01 or ACEA B3/ACEA B4 specification (up to 0.5 l).

Note

Before a long trip, we recommend finding an engine oil that conforms to the corresponding VW specifications and recommend keeping it in the vehicle. This way, the correct engine oil will always be available for a top-up if needed.

Warning lamp

If this warning lamp  is red it indicates that the engine oil pressure is too low.

If this warning symbol starts to flash, and is accompanied by three **audible warnings**, switch off the engine and check the oil level. If necessary, add more oil  **page 268**.

If the warning lamp flashes although the oil level is correct, *stop driving*. Do not even run the engine at idle speed! Obtain technical assistance.

Checking oil level

If the warning lamp is yellow  the engine oil level should be checked as soon as possible. Top up the oil at the next opportunity **» page 268**.

Oil level sensor faulty*

If the  yellow warning lamp flashes, take the vehicle to a specialised workshop to have the oil level sensor checked. Until then it is advisable to check the oil level every time you refuel.

Checking engine oil level

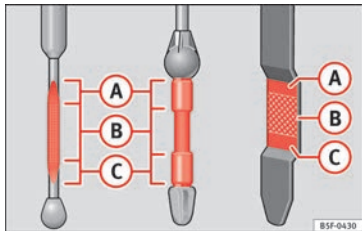

Fig. 230 Engine oil dipstick.

Read the additional information carefully

»  page 58

Checking oil level

- Park the vehicle in a horizontal position.
- Briefly run the engine at idle speed until the operating temperature is reached and then stop.
- Wait for about two minutes.
- Pull out the dipstick. Wipe the dipstick with a clean cloth and insert it again, pushing it in as far as it will go.
- Then pull it out again and check the oil level. Top up with engine oil if necessary.

Depending on how you drive and the conditions in which the vehicle is used, oil consumption can be up to 0.5 l/1000 km. Oil consumption is likely to be higher for the first 5,000 km. For this reason the engine oil level must be checked at regular intervals, preferably when filling the tank and before a journey.

WARNING

Any work carried out in the engine compartment or on the engine must be carried out cautiously.

- When working in the engine compartment, always observe the safety warnings **» page 263**.

CAUTION

If the oil level is above area **» Fig. 230 (A)**, do not start the engine. This could result in damage to the engine and catalytic converter. Contact a Technical Service.

Topping up engine oil

Read the additional information carefully

»  page 58

Before opening the bonnet, read and observe the warnings **»  in Safety notes for work in the engine compartment on page 263**.

The position of the filler neck is shown in the corresponding engine compartment image **» page 266**.

Engine oil specification **»  page 59**.

WARNING

Oil is highly inflammable! Ensure that no oil comes into contact with hot engine components when topping up.

CAUTION

If the oil level is above area **» Fig. 230 (A)**, do not start the engine. This could result in damage to the engine and catalytic converter. Contact a specialised workshop.

For the sake of the environment

The oil level must never be above area **»» Fig. 230 A**. Otherwise oil can be drawn in through the crankcase breather and escape into the atmosphere via the exhaust system.

Changing engine oil

Read the additional information carefully **»»  page 58**

The engine oil must be changed at the intervals given in the service schedule.

We recommend that you have the engine oil changed by a Technical Service.

The oil change intervals are shown in the Maintenance Programme.

WARNING

Only change the engine oil yourself if you have the specialist knowledge required!

- Before opening the bonnet, read and observe the warnings **»» page 263, Safety notes** for work in the engine compartment.
- Wait for the engine to cool down. Hot oil may cause burn injuries.
- Wear eye protection to avoid injuries, such as acid burns, caused by splashes of oil.
- When removing the oil drain plug with your fingers, keep your arm horizontal to help prevent oil from running down your arm.

- Wash your skin thoroughly if it comes into contact with engine oil.
- Engine oil is poisonous! Used engine oil must be stored in a safe place out of the reach of children.

CAUTION

No additives should be used with engine oil. This could result in engine damage. Any damage caused by the use of such additives would not be covered by the factory warranty.

For the sake of the environment



- Because of disposal problems and the special tools and specialist knowledge required, we recommend that you have the engine oil and filter changed by a Technical Service.
- Never pour oil down drains or into the ground.
- Use a suitable container when draining the used oil. It must be large enough to hold all the engine oil.

Cooling system

Control lamp

There is a fault if:

- The  lamp does not go out again after a few seconds.

- The  lamp lights up or flashes while the vehicle is running, and three **acoustic warning signals are emitted** **»» **.

This means that either the coolant level is too low or the coolant temperature is too high.



Coolant temperature too high

If the  lamp lights up, **stop the vehicle, turn off the engine and wait for it to cool down**. Check the coolant level.

If the coolant level is correct, the overheating may be caused by a malfunction of the radiator fan. Check the radiator fan fuse and have it replaced if necessary **»» page 104**.

If the control lamp lights up again after driving on for a short distance, **stop the vehicle and switch the engine off**. Contact a Technical Service or a specialised workshop.

Coolant level too low

If the  lamp lights up, **stop the vehicle, turn off the engine and wait for it to cool down**. First check the coolant level. If the level of the coolant is below the "MIN" mark, top up with coolant liquid **»» **.

WARNING

- If your vehicle is immobilised for technical reasons, move it to a safe distance from traffic. Turn the engine off, turn the hazard lights on and place the warning triangle. **»»**

- Never open the bonnet if you can see or hear steam or coolant escaping from the engine compartment. Risk of scalding. Wait until you can no longer see or hear escaping steam or coolant.
- The engine compartment is a dangerous area. Before carrying out any work in the engine compartment, switch off the engine and allow it to cool down. Always note the corresponding warnings » page 263.

Topping up coolant

Read the additional information carefully »  page 59



Top up coolant when the level is below the MIN (minimum) mark.

Checking coolant level

- Park the vehicle in a horizontal position.
- Switch the ignition off.
- Read off the coolant level on coolant expansion tank. When the engine is cold, the coolant level should be between the marks. When the engine is hot, it may be slightly above the upper mark.

Topping up coolant

- Wait for the engine to cool down.

- Cover the coolant expansion tank cap with a cloth and carefully unscrew it to the left » .
- Top up the coolant only if there is still coolant in the expansion tank, otherwise you could **damage the engine**. If there is no coolant in the expansion tank, do not continue driving. You should obtain professional assistance » .
- If there is still some coolant in the expansion tank, top up to the upper mark.
- Top up with coolant until the level becomes stable.
- Screw the cap back on correctly.

Any loss of coolant fluid normally indicates a leak in the cooling system. Take the vehicle straight to a specialised workshop to have the cooling system examined. If there are no leaks in the engine cooling system, a loss of coolant can only occur if the coolant boils and is forced out of the system as a result of overheating.

WARNING

- The cooling system is under pressure. Do not unscrew the cap on the coolant expansion tank when the engine is hot: risk of burns!
- The antifreeze and coolant fluid can be a health hazard. Therefore, the antifreeze should be stored in the original container in a

safe place out of reach of children. Failure to comply could result in poisoning.

- If working inside the engine compartment, remember that, even when the ignition is switched off, the radiator fan may start up automatically, and therefore there is a risk of injury.

WARNING

If there is not enough anti-freeze in the coolant system, the engine may fail leading to serious damage.

- Please make sure that the percentage of additive is correct with respect to the lowest expected ambient temperature in the zone in which the vehicle is to be used.
- When the outside temperature is very low, the coolant could freeze and the vehicle would be immobilised. In this case, the heating would not work either and inadequately dressed passengers could die of cold.

CAUTION

Do not top up the expansion tank with coolant fluid if it is empty! Air could enter the cooling system. In this case, stop driving. Seek specialist assistance. Otherwise, there is a risk of engine damage.

ⓘ CAUTION

The original additives should never be mixed with coolants which are not approved by SEAT. Otherwise, you run the risk of causing severe damage to the engine and the engine cooling system.

- If the fluid in the expansion tank is not purple but is, for example, brown, this indicates that the G13 additive has been mixed with an inadequate coolant. The coolant must be changed as soon as possible if this is the case! This could result in serious faults and engine damage.

♻️ For the sake of the environment

Coolants and additives can contaminate the environment. If any fluids are spilled, they should be collected and correctly disposed of, with respect to the environment.

Brake fluid**Checking the brake fluid level**

Read the additional information carefully
»  page 60

The position of the brake fluid reservoir is shown in the corresponding engine compartment image » page 266. The brake fluid reservoir has a black and yellow cap.

The brake fluid level drops slightly when the vehicle is being used as the brake pads are automatically adjusted as they wear.

However, if the level goes down noticeably in a short time, or drops below the “MIN” mark, there may be a leak in the brake system. A display on the instrument panel will warn you if the brake fluid level is too low » page 122.

⚠️ WARNING

Before opening the bonnet to check the brake fluid level, read and observe the warnings » page 263.

Changing the brake fluid

The Maintenance Programme indicates brake fluid change intervals.

We recommend that you have the brake fluid changed by a Technical Service.

Before opening the bonnet, please read and follow the warnings »  in Safety notes for work in the engine compartment on page 263 in section “Safety notes for working in the engine compartment”.

In the course of time, brake fluid becomes hygroscopic and absorbs water from the ambient air. If the water content in the brake fluid is too high, the brake system could corrode. This also considerably reduces the boiling point of the brake fluid. Heavy use of the

brakes may then cause a vapour lock which could impair the braking effect.

Be sure to always use the correct brake fluid. Only use brake fluid that expressly meets the VW 501 14 standard.

You can buy VW 501 14 standard brake fluid in a SEAT dealership or a SEAT Official Service. If none is available, use only high-quality brake fluid that meets DIN ISO 4925 CLASS 4 standards, or USA Standards FMVSS 116 DOT 4.

Using any other kind of brake fluid or one that is not of a high quality may affect operation of the brake system and reduce its effectiveness. Never use a brake fluid if the container does not state that it complies with VW 501 14, DIN ISO 4925 CLASS 4 standards, or USA standards FMVSS 116 DOT 4.

⚠️ WARNING

Brake fluid is poisonous. Old brake fluid impairs the braking effect.

- Before opening the bonnet to check the brake fluid level, read and observe the warnings » page 263.

- Brake fluid should be stored in the closed original container in a safe place out of reach of children. There is a toxic risk.

- Perform the brake fluid change according to the Maintenance Programme. Heavy use of the brakes may cause a vapour lock if the brake fluid is left in the brake system for too

»

long. This would seriously affect the effectiveness of the brakes and the safety of the vehicle. This may cause an accident.

ⓘ CAUTION

Brake fluid damages the vehicle paintwork. Wipe off any brake fluid from the paintwork immediately.

♻️ For the sake of the environment

The brake pads and brake fluid must be collected and disposed of according to the applicable regulations. The SEAT Technical Service network has the necessary equipment and qualified personnel for collecting and disposing of this waste material.

Windscreen washer reservoir

Checking and topping up the windscreen washer reservoir water

Read the additional information carefully
»  page 60

The **windscreen washer** is supplied with liquid from the windscreen washer reservoir in the engine compartment. It has a capacity of approximately 3 litres.

The tank is in the engine compartment.

Plain water is not enough to clean the windscreen and headlights. We recommend that you always add a product to the windscreen washer fluid. Approved windscreen cleaning products exist on the market with high detergent and anti-freeze properties, these may be added all-year-round. Please follow the dilution instructions on the packaging.

⚠️ WARNING

Any work carried out in the engine compartment or on the engine must be carried out cautiously.

- When working in the engine compartment, always observe the safety warnings
» page 263.





ⓘ CAUTION

- Never put radiator anti-freeze or other additives into the windscreen washer fluid.
- Always use approved windscreen cleansing products diluted as per instructions. If you use other washer fluids or soap solutions, the tiny holes in the fan-shaped nozzles could become blocked.

Vehicle battery

Symbols and warnings on handling the battery

Read the additional information carefully
»  page 60

	Wear eye protection
	Battery acid is extremely corrosive. Wear protective gloves and eye protection!
	Fires, sparks, open flames and smoking are prohibited!
	A highly explosive mixture of gases is released when the battery is under charge.
	Keep children away from acid and batteries!

⚠️ WARNING

Always be aware of the danger of injury and chemical burns as well as the risk of accident or fire when working on the battery and the electrical system:

- Wear eye protection. Protect your eyes, skin and clothing from acid and particles containing lead.
- Battery acid is extremely corrosive. Wear protective gloves and eye protection. Do not tilt the batteries. This could spill acid through the vents.
- Rinse battery acid from eyes immediately for several minutes with clear water. Then

seek medical care immediately. Neutralise any acid splashes on the skin or clothing with a soapy solution, and rinse off with plenty of water. If acid is swallowed by mistake, consult a doctor immediately.

- Fires, sparks, open flames and smoking are prohibited. When handling cables and electrical equipment, avoid causing sparks and electrostatic charge. Never short the battery terminals. High-energy sparks can cause injury.

- A highly explosive mixture of gases is released when the battery is under charge. The batteries should be charged in a well-ventilated room only.

- Keep children away from acid and batteries.

- Before working on the electrical system, you must switch off the engine, the ignition and all electrical devices. The negative cable on the battery must be disconnected. When a light bulb is changed, you need only switch off the light.

- Deactivate the anti-theft alarm by unlocking the vehicle before you disconnect the battery! The alarm will otherwise be triggered.

- When disconnecting the battery from the vehicle on-board network, disconnect first the negative cable and then the positive cable.

- Switch off all electrical devices before reconnecting the battery. Reconnect first the positive cable and then the negative cable. Never reverse the polarity of the connections. This could cause an electrical fire.

- Never charge a frozen battery, or one which has thawed. This could result in explosions and chemical burns. Always replace a battery which has frozen. A flat battery can also freeze at temperatures close to 0°C (+32°F).

- Ensure that the vent hose is always connected to the battery.

- Never use a defective battery. This could cause an explosion. Replace a damaged battery immediately.

ⓘ CAUTION

- Never disconnect the battery if the ignition is switched on or if the engine is running. This could damage the electrical system or electronic components.

- Do not expose the battery to direct sunlight over a long period of time, as the intense ultraviolet radiation can damage the battery housing.

- If the vehicle is left standing in cold conditions for a long period, protect the battery from "freezing". If it freezes it will be damaged.

Warning lamp



It lights up

Alternator fault.



The control lamp  lights up when the ignition is switched on. It should go out when the engine has started running.



If the control lamp  lights up while driving, the alternator is no longer charging the battery. You should immediately drive to the nearest specialised workshop.

You should avoid using electrical equipment that is not absolutely necessary because this will drain the battery.

Checking the battery electrolyte level

The electrolyte level should be checked regularly in high-mileage vehicles, in hot countries and in older batteries.

– Open the bonnet and open the battery cover at the front   **in Safety notes for work in the engine compartment on page 263**

  **in Symbols and warnings on handling the battery on page 272.** For vehicles with the battery under the spare wheel, open the rear lid and lift the floor covering. The battery is located next to the spare wheel.

– Check the colour display in the "magic eye" on the top of the battery.

– If there are air bubbles in the window, tap the window gently until they disperse. 

The position of the battery is shown in the corresponding engine compartment diagram » page 266.

The “magic eye” indicator, located on the top of the battery changes colour, depending on the charge state and electrolyte level of the battery.

There are two different colours:

- Black: correct charge status.
- Transparent/clear yellow: the battery must be replaced. Contact a specialised workshop.

Charging or changing the battery

The battery is maintenance-free and is checked during the inspection service. All work on the vehicle battery requires specialist knowledge.

If you often drive short distances or if the vehicle is not driven for long periods, the battery should be checked by a specialised workshop between the scheduled services.

If the battery has discharged and you have problems starting the vehicle, the battery might be damaged. If this happens, we recommend you have the vehicle battery checked by a Technical Service where it will be re-charged or replaced.

Charging the battery

The vehicle battery should be charged by a specialised workshop only, as batteries using special technology have been installed and they must be charged in a controlled environment.

Replacing a vehicle battery

The battery has been developed to suit the conditions of its location and has special safety features.

Genuine SEAT batteries meet the maintenance, performance and safety specifications of your vehicle.

WARNING

- We recommend you use only maintenance-free or cycle free leak-proof batteries which comply with standards T 825 06 and VW 7 50 73. This standard applies as of 2001.
- Before starting any work on the batteries, you must read and observe the warnings »  in Symbols and warnings on handling the battery on page 272.



For the sake of the environment

Batteries contain toxic substances such as sulphuric acid and lead. They must be disposed of appropriately and must not be disposed of with ordinary household waste.

Wheels

Wheels and tyres

General notes

Avoiding damage

- If you have to drive over a kerb or similar obstacle, drive very slowly and at a right angle.
- Keep grease, oil and fuel off the tyres.
- Inspect the tyres regularly for damage (cuts, cracks or blisters, etc.). Remove any foreign objects embedded in the treads.

Storing tyres

- When you remove the tyres, mark them in order to maintain the same direction of rotation when they are installed again.
- When removed, the wheels and/or tyres should be stored in a cool, dry and preferably dark location.
- Store tyres in a vertical position, if they are not fitted on wheel rims.

New tyres

New tyres must be run in » page 199.

The tread depth of new tyres may vary, according to the type and make of tyre and the tread pattern.

Concealed damage

Damage to tyres and rims is often not readily visible. If you notice unusual vibrations or the vehicle pulling to one side, this may indicate that one of the tyres is damaged. They should be checked immediately by a Technical Service.

Tyres with directional tread pattern

An arrow on the tyre sidewall indicates the direction of rotation on tyres with directional tread. Always observe the direction of rotation indicated when fitting the wheel. This guarantees optimum grip and helps to avoid aquaplaning, excessive noise and wear.

WARNING

- New tyres do not have maximum grip during the first 500 km. Drive particularly carefully to avoid possible accidents.
- Never drive with damaged tyres. This may cause an accident.
- If you notice unusual vibrations or if the vehicle pulls to one side when driving, stop the vehicle immediately and check the tyres for damage.

Tyre pressure monitoring system

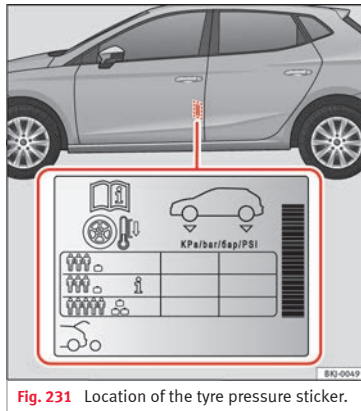

Fig. 231 Location of the tyre pressure sticker.

The maximum tyre pressure values are shown on a sticker stuck to the back of the left front door frame » Fig. 231.

1. Read the required tyre inflation pressure from the sticker. The values refer to Summer tyres.
2. The tyre pressures should only be checked when the tyres are cold. The slightly raised pressures of warm tyres must not be reduced.
3. Adjust the tyre pressure to the load you are carrying.

Tyre pressure

The correct tyre pressure is especially important at high speeds. The pressure should therefore be checked at least once a month and before starting a journey.

Depending on the vehicle, tyre pressure can be adjusted to medium load to improve driving comfort ("comfort" tyre pressure). When driving with comfort tyre pressure fuel consumption may increase slightly.

WARNING

A tyre can easily burst if the pressure is too low, causing an accident!

- At continuously high speeds, a tyre with insufficient pressure flexes more. In this way it becomes too hot, and this can cause tread separation and tyre blow-out. Always observe the recommended tyre pressures.
- If the tyre pressure is too low or too high, the tyres will wear prematurely and the vehicle will not handle well. Risk of accident!

For the sake of the environment

Under-inflated tyres will increase fuel consumption.

Service life of tyres



Fig. 232 Tyre tread wear indicators.

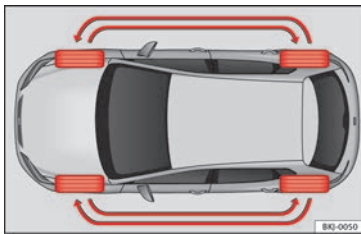



Fig. 233 Diagram for changing wheels.

The useful life of tyres is dependent on tyre pressure, driving style and fitting.

Wear indicators

The original tyres on your vehicle have 1.6 mm high “tread wear indicators” **» Fig. 232**, running across the tread. De-

pending on the make, there will be 6 to 8 of them evenly spaced around the tyre. Markings on the tyre sidewall (for instance the letters “TWI” or other symbols) indicate the positions of the tread wear indicators. The minimum tread depth required by law is 1.6 mm (measured in the tread grooves next to the tread wear indicators). Worn tyres must be replaced. Different figures may apply in export countries **»** .

Tyre pressure

Incorrect tyre pressure causes premature wear and could cause tyre blow-out. For this reason, the tyre pressure should be checked at least once per month **»** page 275.

Driving style

Fast cornering, heavy acceleration and hard braking all increase tyre wear.

Changing wheels around

If the front tyres are worn considerably more than the rear ones it is advisable to change them around as shown **» Fig. 233**. The useful life of all the tyres will then be about the same time.

Wheel balance

The wheels on new vehicles are balanced. However, various factors encountered in normal driving can cause them to become unbalanced, which results in steering vibration.

Unbalanced wheels should be rebalanced, as they otherwise cause excessive wear on steering, suspension and tyres. A wheel must also be rebalanced when a new tyre is fitted.

Incorrect wheel alignment

Incorrect running gear alignment causes excessive tyre wear, impairing the safety of the vehicle. If tyres show excessive wear, you should have the wheel alignment checked by a Technical Service.

WARNING

There is a serious danger of accidents if a tyre bursts during driving!

- The tyres must be replaced at the latest when the tread wear indicators are worn **»** page 276. Failure to follow this instruction could result in an accident. Worn tyres do not grip well at high speeds on wet roads. There is also a greater risk of “aquaplaning”.
- At continuously high speeds, a tyre with insufficient pressure flexes more. This causes it to overheat. This can cause tread separation and tyre blow-out. Risk of accident. Always observe the recommended tyre pressures.
- If tyres show excessive wear, you should have the running gear checked by a Technical Service.
- Keep chemicals such as oil, fuel and brake fluid away from tyres.
- Damaged wheels and tyres must be replaced immediately!

 For the sake of the environment

Under-inflated tyres will increase fuel consumption.

New tyres and wheels

New tyres and wheels have to be run in.

The tyres and wheel rims are an essential part of the vehicle's design. Those approved by SEAT are specially matched to the characteristics of the vehicle and make a major contribution to good road-holding and safe handling »» .

Tyres should be replaced at least in pairs and not individually (i.e. both front tyres or both rear tyres together). A knowledge of tyre designations makes it easier to choose the correct tyres. Radial tyres have the tyre designations marked on the sidewall, for example:

195/55 R16 91V

This contains the following information:

- 195 Tyre width in mm
- 55 Height/width ratio in %
- R Tyre construction: Radial
- 16 Rim diameter in inches
- 91 Load rating code
- V Speed rating

The tyres could also have the following information:

- A direction of rotation symbol
- “Reinforced” denotes heavy-duty tyres.

The manufacturing date is also indicated on the tyre sidewall (possibly only on the outer side of the wheel).

“DOT... 1116...” means, for example, that the tyre was produced in the 11th week of 2016.

We recommend that work on tyres and wheels be carried out by a Technical Service. They are familiar with the procedure and have the necessary special tools and spare parts as well as the proper facilities for disposing of the old tyres.

Any technical service has full information on the technical requirements when installing or changing tyres, wheels or wheel trims.

 **WARNING**

- We recommend that you use only wheels and tyres which have been approved by SEAT for your model. Failure to do so could impair vehicle handling. Risk of accident.
- Avoid running the vehicle on tyres that are more than 6 years old. If you have no alternative, you should drive slowly and with extra care at all times.
- Never use old tyres or those with an unknown “history of use”.

- If wheel trims are retrofitted, you must ensure that the flow of air to the brakes is not restricted. This could cause the brake system to overheat.
- All four wheels must be fitted with radial tyres of the same type, size (rolling circumference) and the same tread pattern.

 For the sake of the environment

Old tyres must be disposed of according to the laws in the country concerned.

 Note

- A SEAT Service Centre should be consulted to find out whether wheels or tyres of different sizes to those originally fitted by SEAT can be fitted, and to find out about the combinations allowed between the front axle (axle 1) and the rear axle (axle 2).
- For technical reasons, it is not generally possible to use the wheels from other vehicles. This can also apply to wheels of the same model. The use of wheels or tyres which have not been approved by SEAT for use with your model may invalidate the vehicle's type approval for use on public roads.
- If the spare tyre is not the same as the tyres that are mounted on the vehicle (e.g. winter tyres) you should only use the spare tyre for a short period of time and drive with extra care. Refit the normal road wheel as soon as possible.

Wheel bolts

The design of wheel bolts is matched to the rims. If different wheel rims are fitted, the correct wheel bolts with the right length and correctly shaped bolt heads must be used. This ensures that wheels are fitted securely and that the brake system functions correctly.

In certain circumstances, you should not use wheel bolts from a different vehicle, even if it is the same model » page 247.

⚠ WARNING

If the wheel bolts are not tightened correctly, the wheel could become loose while driving. Risk of accident.

- The wheel bolts must be clean and turn easily. Never apply grease or oil to them.
- Use only wheel bolts which belong to the wheel.
- If the prescribed torque of the wheel bolts is too low, they could loosen whilst the vehicle is in motion. Risk of accident! If the tightening torque is too high, the wheel bolts and threads can be damaged.

ⓘ CAUTION

The prescribed tightening torque for wheel bolts for steel and alloy wheels is 120 Nm.

Tyre monitoring indicator*



Fig. 234 Centre console: tyre monitoring system button.

The tyre monitoring system compares wheel revolutions alongside the wheel diameter of each wheel, with help from the ESC. If the diameter of a wheel changes, the tyre monitoring indicator lights up (ⓘ). The wheel diameter changes when:

- Tyre pressure is insufficient.
- The tyre structure is damaged.
- The vehicle is unbalanced because of a load.
- The wheels of one axle are under more pressure (for example, driving with a trailer or on steep slopes).
- The vehicle is fitted with snow chains.
- The temporary spare wheel is fitted.
- The wheel on one axle is changed.

Tyre pressure adjustment

After modifying tyre pressure or changing any wheels, the new tyre pressure must be stored in the Easy Connect system with the (CAR) button and the (SETTINGS) function button » » page 34.

In vehicles without a radio, press and hold down the (L) SET button » Fig. 234, with the ignition on, until an acoustic signal is heard.

If the wheels are under excessive load (for example, driving with a trailer or heavy load), the tyre pressure must be increased to the recommended value for a full load (see the sticker on the back of the left front door frame). If the tyre monitor system button is pressed down, the new tyre pressures are confirmed.

The tyre pressure control lamp (ⓘ) lights up

If the tyre pressure of a wheel is much lower than the value set by the driver, then the tyre pressure control lamp » » ⚠ will light up.

⚠ WARNING

- When the tyre pressure control lamp lights up, reduce speed immediately and avoid any sudden turning or braking manoeuvre. Stop when possible, and check the tyre pressure and status.
- The driver is responsible for maintaining correct tyre pressures. For this reason, tyre pressure must be regularly checked.

- Under certain circumstances (e.g. when driving in a sporty manner, in winter conditions or on a dirt track) the tyre control lamp may light up belatedly or may function incorrectly.

Note

If the battery is disconnected, the yellow warning lamp (⚠) lights up after turning the ignition on. This should turn off after a brief journey.

Spare wheel (temporary spare wheel)*

Location and use of the temporary spare wheel

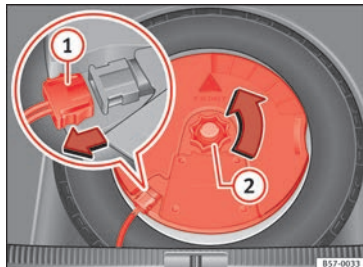

Fig. 235 In the luggage compartment: remove the subwoofer.

The temporary spare wheel is stored under the floor panel in the luggage compartment and is attached by a thumbnut.

How to use the temporary spare wheel

If you ever have a punctured tyre or loss of pressure, the temporary spare wheel is only intended for temporary use until you reach a workshop. Change it for a duty wheel as soon as possible.

Please note the following restrictions when using the temporary spare wheel. This temporary spare wheel has been specially designed for your vehicle, thus, it cannot be changed with the temporary spare wheel from another vehicle.

No other type of tyre (normal summer or winter tyre) may be fitted on the compact temporary spare wheel rim.

Snow chains

For technical reasons, snow chains must not be used on the temporary spare wheel.

If you have a puncture on one of the front wheels when using snow chains, fit the temporary spare wheel in place of one of the rear wheels. Fit the snow chains on the rear wheel that you have removed and replace the punctured front wheel with this wheel.

Getting the spare wheel out of vehicles with the Beats Audio® sound system (6 speakers with 1 subwoofer)*

Disassemble the *subwoofer's* floor panel (carpet) as follows:

- Pull the carpet upwards to remove it.
- Disconnect the cable for the subwoofer speaker » **Fig. 235 ①**.
- Turn the securing wheel anti-clockwise **②**.
- Remove the *subwoofer* speaker and the spare wheel.

- When replacing the spare wheel, place the *subwoofer* speaker in the direction indicated by the arrow and with the word "FRONT" facing forward.
- Reconnect the speaker cable and firmly rotate the securing wheel clockwise so that the *subwoofer* system and wheel are firmly in place.

WARNING

- After fitting the temporary spare wheel, check the tyre pressures as soon as possible. Failure to do so may cause an accident. The tyre pressure is listed on the back of the left front door frame.
- Do not drive at over 80 km/h (50 mph) when the temporary spare wheel is fitted on the vehicle: risk of accident!
- Avoid heavy acceleration, hard braking and fast cornering: risk of accident!
- Never use more than one temporary spare wheel at the same time, risk of accident.
- No other type of tyre (normal summer or winter tyre) may be fitted on the compact temporary spare wheel rim.

Winter service

Winter tyres

In winter conditions winter tyres will considerably improve the vehicle's handling. The

design of summer tyres (width, rubber compound, tread pattern) gives less grip on ice and snow.

Winter **tyres must be inflated to a pressure** of 0.2 bar (2.9 psi/20 kPa) higher than the pressures specified for summer tyres (see the sticker on the back of the left front door frame).

Winter tyres must be fitted on all four wheels.

Information on permitted **winter tyre sizes** can be found in the vehicle's registration documentation. Use only radial winter tyres. All tyre sizes listed in the vehicle documentation also apply to winter tyres.

Winter tyres lose their effectiveness when the tread is worn down to a depth of 4 mm.

The speed rating code **»» page 277, New tyres and wheels** determines the following **speed limits** for winter tyres: **»» **

Q	max. 160 km/h (99 mph)
S	max. 180 km/h (112 mph)
T	max. 190 km/h (118 mph)
H	max. 210 km/h (130 mph)

In some countries, vehicles which can exceed the speed rating of the fitted tyre must have an appropriate sticker in the driver's field of view. These stickers are available from your technical service. The legal requirements of each country must be followed.

Do not have winter tyres fitted for unnecessarily long periods. Vehicles with summer tyres handle better when the roads are free of snow and ice.

If you have a flat tyre, please refer to the notes on the spare wheel **»» page 277, New tyres and wheels**.

WARNING

The maximum speed for the winter tyres must not be exceeded. Otherwise, this could lead to damage and risk of accident.

For the sake of the environment

Fit your summer tyres again as soon as possible. They are quieter, do not wear so quickly and reduce fuel consumption.

Technical data

Technical specifications

Important information

Important

The information in the vehicle documentation always takes precedence over the information in this Instruction Manual.

All technical specifications provided in this documentation are valid for the standard model in Spain. The vehicle data card included in the Maintenance Programme or the vehicle registration documents shows which engine is installed in the vehicle.

The figures may be different depending whether additional equipment is fitted, for different models, for special vehicles and for other countries.

Abbreviations used in the technical specifications section

kW	Kilowatt, engine power measurement.
PS	Pferdestärke (horsepower), formerly used to denote engine power.
rpm	Revolutions per minute - engine speed.
Nm	Newton metres, unit of engine torque.
CZ	Cetane number, indication of the diesel combustion power.
RON	Research octane number, indication of the knock resistance of petrol.

Vehicle identification data

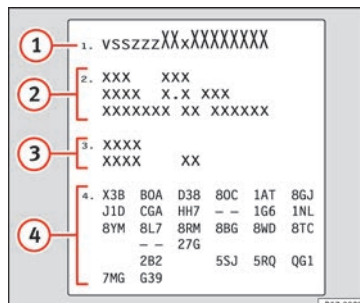

1	1. VSSZZZXXXXXXXXXXXX
2	2. XXX XXX XXXX X.X XXX XXXXXXXX XX XXXXXX
3	3. XXXX XXXX XX
4	4. X3B B0A D38 80C 1AT 8GJ J1D CGA HH7 -- 1G6 1NL 8YM 8L7 8RM 8BG 8WD 8TC -- 27G 2B2 5SJ 5RQ QG1 7MG 639

857-0028

Fig. 236 Vehicle data sticker (luggage compartment).



Fig. 237 Chassis number.

Chassis number

The VIN is located in the Easy Connect, on the vehicle data sticker and under the windscreen, on the driver side »» Fig. 237. Additionally, the chassis number is located in the engine compartment, on the right-hand side. The number is engraved on the top side rail, and is partially covered.

VIN in the Easy Connect

- Select: **CAR** button > function button **SETTINGS** > **Service** > **Chassis number**.

Identification plate

The identification plate is located on the rear pillar of the right-hand front door. Vehicles for certain export countries do not have an identification plate.

Vehicle data sticker

The data sticker is placed on the inside of the spare wheel well, in the boot and on the rear cover of the Maintenance Programme.

The following information is provided on the vehicle data sticker: » Fig. 236

- ① Vehicle identification number (chassis number)
- ② Vehicle type, model, capacity, engine type, finish, engine power and gearbox type
- ③ Engine code, gearbox code, external paint code and internal equipment code
- ④ Optional extras and PR numbers

Identifying letters

The identifying letters of the engine can be viewed on the instrument panel when the engine is switched off and the ignition is on.

- Hold down the button **0.0/SET** on the dash panel for more than 15 seconds.

Fuel consumption data

Fuel consumption

Approved consumption values are derived from measurements performed or supervised by certified EU laboratories, according to the

legislation in force at the time (for more information, see the Publications Office of the European Union on the EUR-Lex website: © European Union, <http://eur-lex.europa.eu/>) and apply to the specified vehicle characteristics.

The values relating to fuel consumption and CO₂ emissions can be found in the documentation provided to the purchaser of the vehicle at the time of purchase.

Fuel consumption and CO₂ emissions depend on the equipment/features of each individual vehicle, as well as on the driving style, road conditions, traffic conditions, environmental conditions, load or number of passengers.

Note

In practice, and considering all the factors mentioned here, consumption values can differ from those calculated in the current European regulations.

Weights

Kerb weight refers to the basic model with a fuel tank filled to 90% capacity and without optional extras. The figure quoted includes 75 kg to allow for the weight of the driver.

Special versions, optional equipment fittings or retro-fitting accessories will increase the weight of the vehicle » .

WARNING

- **Please note that the centre of gravity may shift when transporting heavy objects; this may affect vehicle handling and lead to an accident. Always adjust your speed and driving style to suit road conditions and requirements.**
- **Never exceed the gross axle weight rating or the gross vehicle weight rating. If the permissible axle load or the permissible total weight is exceeded, the driving characteristics of the vehicle may change, leading to accidents, injuries and damage to the vehicle.**

Trailer mode

Trailer weights

The trailer weights and drawbar loads approved are selected in intensive trials according to precisely defined criteria. The approved trailer weights are valid for vehicles in the EU for maximum speeds of 80 km/h (50 mph) (in certain circumstances up to 100 km/h (62 mph)). The figures may be different in other countries. All data in the official vehicle documentation takes precedence over these data at all times » .

Drawbar loads

The *maximum* permitted drawbar load on the ball joint of the towing bracket must not exceed **50 kg**.

In the interest of road safety, we recommend that you always tow approaching the maximum drawbar load. The response of the trailer on the road will be poor, if the drawbar load is too small.

If the maximum permissible drawbar load cannot be met (e.g. with small, empty and light-weight single axle trailers or tandem axle trailers with a wheelbase of less than 1 metre), a minimum of 4% of the actual trailer weight is legally required for the drawbar load.

WARNING

- For safety reasons, you should not drive at speeds above 80 km/h (50 mph) when towing a trailer. This also applies in countries where higher speeds are permitted.
- Never exceed the maximum trailer weights or the drawbar load. If the permissible axle load or the permissible total weight is exceeded, the driving characteristics of the vehicle may change, leading to accidents, injuries and damage to the vehicle.

Wheels

Tyre pressure, snow chains and wheel bolts

Tyre pressure

The sticker with the tyre pressure values can be found on the back of the left front door frame. The tyre pressure values given there are for *cold* tyres. Do not reduce the slightly raised pressures of warm tyres **»»** .

The pressure for winter tyres is 0.2 bar higher than that of summer tyres (2.9 psi / 20 kPa).

Snow chains

Snow chains may be fitted only to the front wheels, and only for the following tyres:

185/70 R14	Chains with links of maximum 13.5 mm
185/65 R15	Chains with links of maximum 13.5 mm
195/55 R16	Chains with links of maximum 9 mm

Wheel bolts

After the wheels have been changed, the **tightening torque** of the wheel bolts should be checked as soon as possible with a torque wrench **»»** . The tightening torque for steel and alloy wheels is **120 Nm**.

WARNING

- Check the tyre pressure at least once per month. Checking the tyre pressure is very important. If the tyre pressure is too high or too low, there is an increased danger of accidents - particularly at high speeds.
- If the tightening torque of the wheel bolts is too low, they could loosen while the vehicle is in motion. Risk of accident! If the tightening torque is too high, the wheel bolts and threads can be damaged.

Note

We recommend that you ask your Technical Service for information about appropriate wheel, tyre and snow chain size.

Engine data

Petrol engine 1.0 MPI 48 kW (65 PS) Start-Stop

Power output in kW (PS) at rpm	Maximum torque (Nm at rpm)	No. of cylinders/displacement (cm ³)	Fuel
48 (65)/5,000-6,000	95/3,000-4,300	3/999	Super 95 RON/Normal 91 RON ^{a)}

^{a)} Slight power loss.

Outputs and weights	Manual gearbox
Top speed (km/h)	162 (V)
Acceleration from 0-80 km/h (seconds)	9.9
Acceleration from 0-100 km/h (seconds)	15.2
Maximum authorised weight (kg)	1,510-1,610 ^{a)}
Weight in running order (with driver) (kg)	1,091
Maximum authorised weight on front axle (kg)	810
Maximum authorised weight on rear axle (kg)	750-850 ^{b)}
Permitted roof load (kg)	75
Maximum trailer weight without brakes (kg)	580
Weight of trailer with brakes, gradients up to 8% (kg)	1,000
Weight of trailer with brakes, gradients up to 12% (kg)	800

^{a)} Varies depending on the features (Splitting).

^{b)} Varies depending on the rear spring.

Technical specifications

Petrol engine 1.0 MPI 55 kW (75 PS) Start-Stop

Power output in kW (PS) at rpm	Maximum torque (Nm at rpm)	No. of cylinders/displacement (cm ³)	Fuel
55 (75)/6,200	95/3,000-4,300	3/999	Super 95 RON/Normal 91 RON ^{a)}

^{a)} Slight power loss.

Outputs and weights	Manual gearbox
Top speed (km/h)	167 (IV)
Acceleration from 0-80 km/h (seconds)	9.5
Acceleration from 0-100 km/h (seconds)	14.7
Maximum authorised weight (kg)	1,500-1,600 ^{a)}
Weight in running order (with driver) (kg)	1,085
Maximum authorised weight on front axle (kg)	800
Maximum authorised weight on rear axle (kg)	750-850 ^{b)}
Permitted roof load (kg)	75
Maximum trailer weight without brakes (kg)	580
Weight of trailer with brakes on gradients up to 8% (kg)	1,000
Weight of trailer with brakes on gradients up to 12% (kg)	800

^{a)} Varies depending on the features (Splitting).

^{b)} Varies depending on the rear spring.

Technical data

Petrol engine 1.6 MPI 66 kW (90 PS)

Power output in kW (PS) at rpm	Maximum torque (Nm at rpm)	No. of cylinders/displacement (cm ³)	Fuel
66 (90)/4,250-6,000	155/3,800-4,000	4/1,598	Super 95 RON/Normal 91 RON ^{a)}

a) Slight power loss.

Outputs and weights	Manual gearbox
Top speed (km/h)	182
Acceleration from 0-80 km/h (seconds)	7.2
Acceleration from 0-100 km/h (seconds)	10.9
Maximum authorised weight (kg)	1,530-1,630 ^{a)}
Weight in running order (with driver) (kg)	1,116
Maximum authorised weight on front axle (kg)	830
Maximum authorised weight on rear axle (kg)	750-850 ^{b)}
Permitted roof load (kg)	75
Maximum trailer weight without brakes (kg)	560
Weight of trailer with brakes on gradients up to 8% (kg)	1,100
Weight of trailer with brakes on gradients up to 12% (kg)	1,000

a) Varies depending on the features (Splitting).

b) Varies depending on the rear spring.

Technical specifications

Petrol engine 1.0 EcoTSI 70 kW (95 PS) Start-Stop

Power output in kW (PS) at rpm	Maximum torque (Nm at rpm)	No. of cylinders/displacement (cm ³)	Fuel
70 (95)/5,000-5,500	175/1,500-3,500	3/999	Super 95 RON/Normal 91 RON ^{a)}

^{a)} Slight power loss.

Outputs and weights	Manual gearbox
Top speed (km/h)	182 (IV)
Acceleration from 0-80 km/h (seconds)	7.2
Acceleration from 0-100 km/h (seconds)	10.9
Maximum authorised weight (kg)	1,540-1,640 ^{a)}
Weight in running order (with driver) (kg)	1,122
Maximum authorised weight on front axle (kg)	840
Maximum authorised weight on rear axle (kg)	750-850 ^{b)}
Permitted roof load (kg)	75
Maximum trailer weight without brakes (kg)	560
Weight of trailer with brakes on gradients up to 8% (kg)	1,100
Weight of trailer with brakes on gradients up to 12% (kg)	1,000

^{a)} Varies depending on the features (Splitting).

^{b)} Varies depending on the rear spring.

Technical data

Petrol engine 1.6 MPI 81 kW (110 PS)

Power output in kW (PS) at rpm	Maximum torque (Nm at rpm)	No. of cylinders/displacement (cm ³)	Fuel
81 (110)/5,800	155/3,800-4,000	4/1,598	Super 95 RON/Normal 91 RON ^{a)}

a) Slight power loss.

Outputs and weights	Manual gearbox	Automatic
Top speed (km/h)	190	192
Acceleration from 0-80 km/h (seconds)	7.0	7.2
Acceleration from 0-100 km/h (seconds)	10.4	10.4
Maximum authorised weight (kg)	1,530-1,630 ^{a)}	1,570-1,670 ^{a)}
Weight in running order (with driver) (kg)	1,123	1,153
Maximum authorised weight on front axle (kg)	830	870
Maximum authorised weight on rear axle (kg)	750-850 ^{b)}	750-850 ^{b)}
Permitted roof load (kg)	75	75
Maximum trailer weight without brakes (kg)	560	570
Weight of trailer with brakes on gradients up to 8% (kg)	1,100	1,100
Weight of trailer with brakes on gradients up to 12% (kg)	1,000	1,000

a) Varies depending on the features (Splitting).

b) Varies depending on the rear spring.

Technical specifications

Petrol engine 1.0 EcoTSI 85 kW (115 PS) Start-Stop

Power output in kW (PS) at rpm	Maximum torque (Nm at rpm)	No. of cylinders/displacement (cm ³)	Fuel
85 (115)/5,000-5,500	200/2,000-3,500	3/999	Super 95 RON/Normal 91 RON ^{a)}

^{a)} Slight power loss.

Outputs and weights	Manual gearbox	Automatic gearbox
Top speed (km/h)	195 (V)	193 (VI)
Acceleration from 0-80 km/h (seconds)	6.4	6.5
Acceleration from 0-100 km/h (seconds)	9.3	9.4
Maximum authorised weight (kg)	1,560-1,660 ^{a)}	1,580-1,680 ^{a)}
Weight in running order (with driver) (kg)	1,140	1,164
Maximum authorised weight on front axle (kg)	860	880
Maximum authorised weight on rear axle (kg)	750-850 ^{b)}	750-850 ^{b)}
Permitted roof load (kg)	75	75
Maximum trailer weight without brakes (kg)	570	580
Weight of trailer with brakes, gradients up to 8% (kg)	1,200	1,200
Weight of trailer with brakes, gradients up to 12% (kg)	1,100	1,100

^{a)} Varies depending on the features (Splitting).

^{b)} Varies depending on the rear spring.

Technical data

Petrol engine 1.5 TSI Evo 110 kW (150 CV) ACT®

Power output in kW (PS) at rpm	Maximum torque (Nm at rpm)	No. of cylinders/displacement (cm ³)	Fuel
110 (150)/5,000-6,000	250/1,500-3,500	4/1,498	Super 95 RON/Normal 91 RON ^{a)}

a) Slight power loss.

Outputs and weights	Manual gearbox
Top speed (km/h)	215 (V)
Acceleration from 0-80 km/h (seconds)	5.5
Acceleration from 0-100 km/h (seconds)	7.7
Maximum authorised weight (kg)	1,600-1,700 ^{a)}
Weight in running order (with driver) (kg)	1,184
Maximum authorised weight on front axle (kg)	900
Maximum authorised weight on rear axle (kg)	750-850 ^{b)}
Permitted roof load (kg)	75
Maximum trailer weight without brakes (kg)	590
Weight of trailer with brakes on gradients up to 8% (kg)	1,200
Weight of trailer with brakes on gradients up to 12% (kg)	1,200

a) Varies depending on the features (Splitting).

b) Varies depending on the rear spring.

Technical specifications

Petrol engine/CNG 1.0 MPI 66 kW (90 PS) Start-Stop

Power output in kW (PS) at rpm	Maximum torque (Nm at rpm)	No. of cylinders/displacement (cm ³)	Fuel
66 (90)/4,500-5,800	160/1,900-3,500	3/999	CNG
			Super 95 RON/Normal 91 RON ^{a)}

^{a)} Slight power loss.

Outputs and weights	Manual gearbox
Top speed (km/h)	181
Acceleration from 0-80 km/h (seconds)	7.7
Acceleration from 0-100 km/h (seconds)	11.8
Maximum authorised weight (kg)	1,640
Weight in running order (with driver) (kg)	1,239
Maximum authorised weight on front axle (kg)	^{a)}
Maximum authorised weight on rear axle (kg)	^{a)}
Permitted roof load (kg)	75
Maximum trailer weight without brakes (kg)	610
Weight of trailer with brakes on gradients up to 8% (kg)	^{a)}
Weight of trailer with brakes on gradients up to 12% (kg)	^{a)}

^{a)} Data not available as this edition goes to print.

Diesel engine 1.6 TDI CR 59 kW (80 PS) Start-Stop

Power output in kW (PS) at rpm	Maximum torque (Nm at rpm)	No. of cylinders/displacement (cm ³)	Fuel
59 (80)/2,700-4,800	230/1,400-2,400	4/1,598	Diesel according to standard EN 590, min. 51 CZ

Outputs and weights	Manual gearbox
Top speed (km/h)	172 (IV)
Acceleration from 0-80 km/h (seconds)	8.4
Acceleration from 0-100 km/h (seconds)	13
Maximum authorised weight (kg)	1,670-1,750 ^{a)}
Weight in running order (with driver) (kg)	1,247
Maximum authorised weight on front axle (kg)	b)
Maximum authorised weight on rear axle (kg)	b)
Permitted roof load (kg)	75
Maximum trailer weight without brakes (kg)	620
Weight of trailer with brakes on gradients up to 8% (kg)	1,200
Weight of trailer with brakes on gradients up to 12% (kg)	1,000

^{a)} Varies depending on the features (Splitting).

^{b)} Data not available as this edition goes to print.

Technical specifications

Diesel engine 1.6 TDI CR 70 kW (95 PS) Start-Stop

Power output in kW (PS) at rpm	Maximum torque (Nm at rpm)	No. of cylinders/displacement (cm ³)	Fuel
70 (95)/2,750-4,600	250/1,500-2,600	4/1,598	Diesel according to standard EN 590, min. 51 CZ

Outputs and weights	Manual gearbox
Top speed (km/h)	182 (IV)
Acceleration from 0-80 km/h (seconds)	7.4
Acceleration from 0-100 km/h (seconds)	11.1
Maximum authorised weight (kg)	1,670-1,750 ^{a)}
Weight in running order (with driver) (kg)	1,253
Maximum authorised weight on front axle (kg)	950
Maximum authorised weight on rear axle (kg)	770-850 ^{b)}
Permitted roof load (kg)	75
Maximum trailer weight without brakes (kg)	620
Weight of trailer with brakes on gradients up to 8% (kg)	1,200
Weight of trailer with brakes on gradients up to 12% (kg)	1,100

^{a)} Varies depending on the features (Splitting).

^{b)} Varies depending on the rear spring.

Diesel engine 1.6 TDI CR 85 kW (115 PS) Start-Stop

Power output in kW (PS) at rpm	Maximum torque (Nm at rpm)	No. of cylinders/displacement (cm ³)	Fuel
85 (115)/3,250-4,000	250/1,500-3,200	4/1,598	Diesel according to standard EN 590, min. 51 CZ

Outputs and weights	Manual gearbox
Top speed (km/h)	195 (VI)
Acceleration from 0-80 km/h (seconds)	6.4
Acceleration from 0-100 km/h (seconds)	9.6
Maximum authorised weight (kg)	1,680-1,760 ^{a)}
Weight in running order (with driver) (kg)	1,258
Maximum authorised weight on front axle (kg)	b)
Maximum authorised weight on rear axle (kg)	b)
Permitted roof load (kg)	75
Maximum trailer weight without brakes (kg)	620
Weight of trailer with brakes on gradients up to 8% (kg)	1,200
Weight of trailer with brakes on gradients up to 12% (kg)	1,200

a) Varies depending on the features (Splitting).

b) Data not available as this edition goes to print.

Dimensions

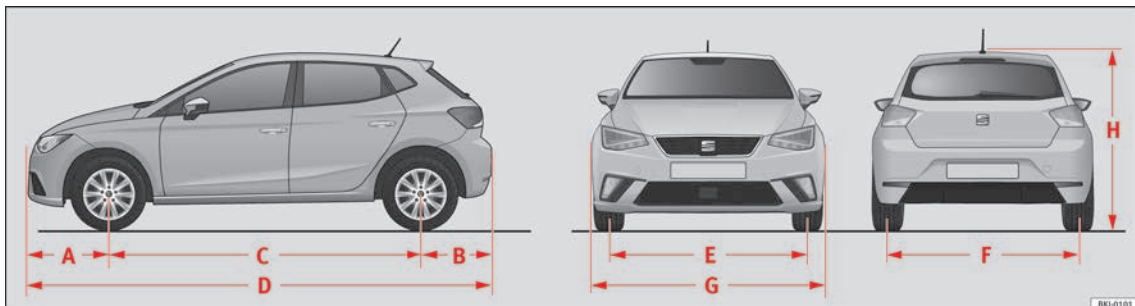

Fig. 238 Dimensions.

Fig. 238		IBIZA
A/B	Front and rear projections (mm)	796/699
C	Wheelbase (mm)	2,564
D	Length (mm)	4,059
E/F	Front/rear ^{a)} track width (mm)	1,525/1,505
G	Width (mm)	1,780
H	Height at kerb weight (mm)	1,444

^{a)} This data will change depending on the type of wheel rim. Values for wheel 185/70 R14 ET38.

Index

A

- ABS 187
 - control lamp 187
- ACC
 - see Adaptive cruise control 216
- Accessories 247
- Adaptive cruise control 207, 216
 - deactivating temporarily 223
 - function for preventing overtaking in an inside lane 222
 - indications on the display 218
 - malfunction 217
 - operating 219
 - radar sensor 219
 - special driving situations 223
 - warning and control lamp 218
- AdBlue
 - information 261
 - maximum filling capacity 261
 - refilling 262
 - specification 262
 - tank capacity 261
- Additional consumers (efficiency program) 42
- Adjusting
 - CAR menu 123
 - front head restraints 79
 - lights 149
 - rear head restraints 79, 155
 - seats 76
- Adjusting the front seats
 - adjusting the lumbar support 154
- Adjusting the head restraints
 - front head restraints 155
 - rear head restraints 79
- Adjusting the seat 154
- Adjustment
 - front head restraints 155
- Airbag covers 21
- Airbags 86
 - description 87
- Airbag system 21, 86
 - activation 87
 - control lamp 91
 - deactivation of front airbag 90
 - description 87
 - front airbags 21, 88
 - functioning 87
 - head-protection airbags 23, 89
 - side airbags 22, 88
- Air conditioning 51
 - Climatronic 173
 - controls 171
 - general notes 166
 - manual air conditioning 54
- Air outlets 168
- Air recirculation
 - air conditioning 168
- Alarm system 138
 - switching off 139
- Alcantara: cleaning 256
- Alloy wheel rims 253
- Alternator
 - warning lamp 273
- Ambient lighting 151
- Anchoring
 - the front tow line 102
- Anti-freeze 59
- Anti-lock brake system 183, 185, 187
 - control lamp 187
- Anti-puncture 64, 98
 - check after 10 minutes 99
- Anti-puncture set 98
- Anti-theft alarm 138
 - trailer 245
 - vehicle interior monitoring and anti-tow protection 140
- Anti-theft alarm system 138
 - switching off 139
- Anti-theft security system 15
- Anti-tow protection 140
- Anti-trap function
 - Sun blind (sunroof) 145
 - sunroof 145
- Aquaplaning 276
- Ashtray 159
- Aspects to note before setting off 75
- ASR 184
 - control lamp 184
- Assistance systems
 - adaptive cruise control (ACC) 216
 - Cruise control system 207
 - emergency brake assist (Front Assist) 212
 - fatigue detection 227
 - parking aid 228, 229
 - speed limiter 209
- Assisted starting 71
- Audible signal
 - unfastened safety belt 81
- Audible warning signal
 - warning and control lamps 122
- Automatic car wash tunnel 249
- Automatic gearbox 190
 - downhill speed control 195
 - driving tips 193
 - emergency program 196
 - kick-down feature 194
 - launch control program 194

- manual release of the selector lever 50
 - selector lever lock 191
 - selector lever positions 190
 - steering wheel with gear shift paddles 192
 - tiptronic 190, 192
 - Automatic lighting 146
 - AUX-IN 129
- B**
- Back seat
 - folding down and raising the back seat back-rest 157
 - Battery 131
 - Before setting off 75
 - Belt tensioners
 - control lamp 91
 - Belt tightening 85
 - Biodiesel 260
 - Bonnet 17, 263, 266
 - closing 265
 - opening 264
 - Brake assist 183
 - Brake fluid 60, 271
 - changing 271
 - Brake pads 181, 199
 - Brakes
 - brake fluid 271
 - new Brake pads 181
 - Brake servo 181, 188
 - Brake system 271
 - Braking
 - brake assist 183
 - Braking distance 181
 - Braking system
 - warning lamp 181
 - Bulbs
 - changing the bulbs 106
 - Buzzer 148
- C**
- Capacities 57
 - AdBlue tank 261
 - fuel tank 121
 - Capacity
 - natural gas tank 258
 - Car care
 - exterior 249
 - Care and cleaning 248
 - Catalytic converter 202
 - malfunction 202
 - CCS 45
 - Central locking
 - anti-theft alarm 138
 - automatic speed-dependent locking 134
 - central locking button 134
 - electric windows 143
 - emergency locking 16
 - key by remote control 130
 - Keyless Access 135
 - Panoramic sliding/tilting sunroof 143
 - selective unlocking system 133
 - self-locking system to prevent involuntary un-locking 134
 - unlocking system 134
 - Central locking system 132
 - safe security system 132
 - Central wheel trim 65, 66
 - Centre console 11
 - Cetane number (diesel fuel) 260
 - Changing a bulb
 - additional brake light 111
 - fog light bulbs 109
 - general notes 106
 - interior light and reading light 111
 - luggage compartment light 111
 - number plate light 110
 - tail light bulbs 109
 - turn signal light 108
 - Changing a double headlight bulb
 - dipped beam headlights 108
 - double headlight bulbs 107
 - main beam headlights 107
 - Changing a wheel
 - subsequent work 69
 - wheel bolts 67
 - Changing settings
 - CAR menu 34
 - Changing the blades 100
 - Charging the battery 71
 - Checking levels
 - engine compartment 266
 - Childproof locks
 - electric windows 141
 - Child seats 23, 93
 - categorisation into groups 94
 - ISOFIX system 27
 - safety instructions 24, 92
 - securing with seat belt 25
 - Top Tether system 27, 30
 - Chrome parts
 - cleaning 252
 - Cigarette lighter 160
 - Cleaning
 - adhesive sheets 250
 - alcantara 256
 - alloy wheel rims 253
 - chrome parts 252
 - Easy Connect control panel 254
 - engine compartment 253
 - fabrics 254
 - high pressure cleaners 250

- leather 255
 - plastic parts 251, 254
 - radio screen 254
 - rubber seals 252
 - seat belts 256
 - steel wheel rims 253
 - washing the vehicle 249
 - windows and exterior mirrors 251
 - windscreen wiper blades 252
 - wooden trim 254
 - Climatronic 52
 - adjusting the temperature 174
 - automatic mode 174
 - controls 173
 - fan regulation 174
 - general notes 166
 - windscreen defrost 174
 - Close
 - sunroof 144
 - Closing 130
 - bonnet 265
 - sunroof 144
 - windows 141
 - Clutch (warning lamp) 196
 - Coming Home 148
 - Coming Home Function 148
 - Connectivity Box 129
 - Contact key 175
 - Control and warning lamps
 - airbag system 91
 - alternator 273
 - Anti-lock brake system (ABS) 187
 - ASR 184
 - braking system 181
 - coolant 269
 - cruise control system (CCS) 208
 - depress the brake 212
 - diesel particulate filter 202
 - EDL 186
 - emission control 203
 - engine oil 267
 - ESC 183
 - instrument panel 47, 49
 - lights 146
 - speed limiter 209
 - steering column lock 198
 - tyres 278
 - Controls and displays
 - general instrument panel 115
 - Controls for the windows 18, 141
 - Controls on the steering wheel
 - without voice control 127
 - with voice control 125
 - Coolant
 - checking level 270
 - Coolant level
 - control lamp 269
 - Coolant temperature
 - control lamp 269
 - safety instructions 270
 - Cooling
 - coolant temperature gauge 120
 - Cooling system
 - checking coolant 269, 270
 - topping up coolant 269, 270
 - Correct sitting position 76
 - driver 76
 - front passenger 77
 - rear seat passengers 78
 - Cruise control 45
 - control and warning lamps 208
 - operation 208
 - Cruise control system 207
 - Current 160
- ## D
- Dangers in not using the seat belt 83
 - Dash panel 47
 - Data label 281
 - Deactivating the front passenger front airbag ... 22
 - Deactivation of front airbag 90
 - Detachable ball
 - assembling 239
 - checking attachment 240
 - placing in standby position 238
 - removing 240, 241
 - standby position 238
 - Diesel
 - diesel particulate filter 202
 - refuelling 260
 - Diesel particulate filter 202
 - malfunction 202
 - Digital clock 118
 - Dimensions 295
 - Direction of rotation
 - tyres 69
 - Display 117, 118
 - Display messages
 - speed limiter 209
 - Disposal
 - belt tensioners 85
 - Distance control
 - see Adaptive cruise control 216
 - Door cylinder 15
 - Door handle 15
 - de-icing 252
 - Door lock 15
 - de-icing 252
 - Door lock cylinder
 - de-icing 252
 - Door release lever 115

- Doors
 - childproof locks 138
 - opening and closing 15
- Double headlight bulbs 107
- Downhill speed control 195
- Downhill speed control function 195
- Driver
 - see Correct sitting position 76, 77, 78
- Driver-side general instrument panel
 - left-hand drive 9
 - right-hand drive 10
- Driver information system
 - additional consumers 42
 - assist systems 40
 - bonnet, rear lid and doors open 40
 - engine oil temperature 42
 - gear-change indicator 41
 - journey data 38
 - menu 38
 - operation 37
 - outside temperature 41
 - saving tips 42
 - service intervals 43
 - speed warning 42
 - warning and information messages 41
- Driving
 - driving abroad 203
 - driving through water 204
 - economic 200
 - safe 75
 - with a trailer 242, 244, 245
 - with trailer 237
- Driving abroad
 - headlights 203
 - petrol 203
- Driving data
 - data summary 39
- Driving mode 226
- Driving on flooded roads 204
- Driving profile 226
- DSG 190
- Duplicate keys 130
- Dust and pollen filter 166
- Dynamic lights range control 149
- E**
- E10
 - see Ethanol (fuel) 258
- Easy Connect 34, 123
- Easy Connect System 123
- EDL
 - see Electronic differential lock 186
- EDS 186
- Efficiency program
 - additional consumers 42
 - saving tips 42
- Electrical power socket 160
- Electrical socket
 - trailer 243
- Electric windows 18, 141
 - convenience opening and closing 143
- Electrolyte 273
- Electronic differential lock 183, 186
 - control lamp 186, 187
- Electronic differential lock control 185
- Electronic differential lock (XDS) 188
- Electronic immobiliser 15, 177
- Electronic Stability Control (ESC) 183, 185
- Emergencies 97
 - automatic gearbox emergency program 196
 - bulbs 63
 - changing a wheel 65
 - changing the battery 274
 - emergency towing of the vehicle 70
 - emergency warning triangle 97
 - fire extinguisher 97
 - first-aid kit 97
 - fuses 62
 - hazard warning lights 150
 - jump leads 71
 - puncture 63
 - replacing a blown fuse 62
 - Spare wheel 279
 - vehicle tools 97
- Emergency braking assistance system
 - indications on the display 212
 - malfunction 214
 - operating 215
 - radar sensor 214
 - switching off temporarily 216
 - system limitations 216
- Emergency operation
 - front passenger door 16
 - selector lever 50
- Emergency warning triangle 97
- Emission control system
 - catalytic converter 202
 - control lamp 203
 - diesel particulate filter 202
- Emissions data 282
- Engine
 - assisted starting 71
 - noises 180
 - running in 199
 - Start-Stop system 204
- Engine and ignition
 - automatic ignition switch-off 178
 - My Beat 180
 - preheating the engine 179
 - starting the engine 179

- starting the engine with Press & Drive 179
 - stopping the engine 180
 - Engine compartment 17, 263, 266
 - battery 272
 - brake fluid 271
 - closing 265
 - coolant 269, 270
 - engine oil 266, 268
 - opening 264
 - safety notes 263
 - windscreen washer liquid 272
 - Engine coolant 59
 - checking level 269
 - G12 plus-plus 59
 - G13 59
 - specifications 59
 - Engine data 284
 - Engine fault
 - control lamp 203
 - Engine management
 - control lamp 203
 - Engine oil 58, 266
 - changing 266, 269
 - checking engine oil level 268
 - consumption 268
 - diesel 266
 - dipstick 268
 - inspection service 266
 - maintenance intervals 266
 - oil properties 58
 - specifications 59, 266
 - temperature display 42
 - topping up 268
 - Engine oil pressure
 - control lamp 267
 - Environment
 - environmental compatibility 199
 - environmentally-friendly driving 200
 - Environmental tip
 - refuelling 257
 - Equipment 247
 - ESC 183
 - electronic stability control 183, 185
 - Multi-collision Brake 188
 - Sport Mode 185
 - Ethanol (fuel) 258
 - Event Data Recorder 96
 - Exhaust purification system for vehicles with
 - diesel engines 261
 - Extending
 - the luggage compartment 157
 - Exterior lighting
 - changing the bulbs 106
 - Exterior mirrors 153
 - adjusting 20
 - control 153
 - folding in electrically 153
 - folding in manually 153
 - heated 153
 - Exterior view 7, 8
 - External aerial 247
- F**
- Fastening rings 162
 - Fatigue detection 227
 - Fault in electronic differential lock (EDL)
 - control lamp 186
 - Faulty bulbs
 - changing the bulbs 106
 - Filling up the tank 257
 - Fire extinguisher 97
 - First-aid kit 97
 - Floor mats 80
 - Fluid level control 57
 - Fog light bulb 109
 - Front airbags 21, 88
 - safety instructions 88
 - Front Assist
 - indications on the display 212
 - Front drink holder 159
 - Front passenger front airbag
 - control lamp 91
 - deactivation 22
 - Front seat
 - manual adjustment 19
 - Fuel 57, 258
 - consumption 282
 - diesel 260
 - ethanol 258
 - fuel gauge 121
 - natural gas 260
 - refuelling 258
 - saving 200
 - Fuel consumption 200
 - why does fuel consumption increase? 202
 - Fuel tank cap
 - opening and closing 57
 - Fuses 62, 104
 - fuse box 104
 - identifying blown fuses 63
 - identifying by colours 62
 - preparation before replacing 62
 - replacing 62
- G**
- Gear-change indicator 41, 197
 - Gearbox DSG
 - see Automatic gearbox 190
 - Gearbox lever 50

- Gear change 50
 automatic 50
 changing gears (manual gearbox) 189
 kick-down 227
 manual 50
 manual gearbox 189
 Gear engaged 50
 Gear recommendation 41
 Gear shift paddles (automatic gearbox) 192
 General instrument panel
 controls and displays 115
 turn signal and main beam lever 147
 warning and indication lamps 47
 General overview of the engine compartment .. 266
 Glove compartment 158
 Glove plug system 176
- H**
- Handbrake 182
 warning lamp 182
 Hazard warning lights 32, 150
 HBA 186
 Head-on collisions and their laws of physics 83
 Head-protection airbags
 description 23
 safety instructions 23
 Headlights
 driving abroad 203
 fog lights 147
 Head restraints 19
 adjustment 155
 front head restraints 79
 rear head restraints 79
 Headrests 19
 adjustment 155
 front 79
 rear 79
- Heated rear window 53, 54, 56
 heating element wires 252
 switch 151
 Heating 170
 defrosting the windscreen 170
 demisting the windscreen and side windows 170
 Heating and fresh air 55, 169
 Heating and fresh air system
 controls 169
 Heating or cooling the interior 171
 Heating system 170
 Hill driving assistant 189
 Horn 115
 How to jump start 71
 description 72
 Hydraulic Brake Assist
 automatic hazard warning lights activation .. 186
- I**
- Identification plate 281
 Identifying letters on engine 282
 Ignition 31, 175
 Ignition lock 31, 175
 see also Starter button 178
 Incorrect position 78
 Indications on the display 118
 ACT 200
 adaptive cruise control 218
 assist systems submenu 40
 compass 119
 distance travelled 118
 doors, bonnet and rear lid open 40
 Driver information system 37
 ECO 119
 Emergency brake assist system (Front Assist) 212
 journey data 38
 MKB 119
- outside temperature 41
 recommended gear 119
 SEAT Drive Profile 225
 second speed display 119
 selector lever position 119
 selector lever positions 190
 service intervals 43
 speed warning 119
 Start-Stop 119
 time 119
 warning and control lamps 218
 warning and information messages 41
 Inertia mode 195
 Infotainment system 34
 Inspection 266
 Inspection service 266
 Instrument panel 117
 display 117, 118
 instruments 117
 odometer 120
 service interval indication 43
 warning and control lamps 122
 Instrument panel lighting 150
 Instruments 117
 Interior bulbs 111
 Interior lights 33
 Interior mirror 152
 anti-dazzle 153
 Interior view 14
 ISOFIX 27, 29
 ISOFIX system 27
- J**
- Jack 65
 mounting points 68
 Journey data 37
 memory 38

- Jump leads 71
- K**
- Key-operated switch 90
- Key by remote control
unlocking and locking 130
- Keyless Access
Keyless Entry 135
Keyless Exit 135
Press & Drive 178
special characteristics 137
starting the engine 179
unlocking and locking the vehicle 135
- Keyless Access lock and ignition system:
see Keyless Access 135
- Keyless Entry
see Keyless Access 135
- Keyless Exit
see Keyless Access 135
- Keys
replacing the battery 131
spare key 130
synchronise 132
unlocking and locking 15, 130
vehicle key 130
- Kick-down
automatic gearbox 194
manual gearbox 227
- L**
- Launch control (automatic gearbox) 194
- Leaving Home 148
- Leaving Home Function 148
- Lifting the vehicle 68
- Lights 31, 146
additional brake light 111
automatic lighting 146
changing the bulbs 106
coming home 148
Control and warning lamps 146
daytime running lights 147
fog lights 147
fog lights with cornering function 149
instrument lighting 150
interior light and front reading lights 111
interior lights 151
leaving home 148
lights range control 149
light switch 146
luggage compartment light 111
main beam lever 147
main beams 32
motorway light 149
number plate light 110
parking lights 147
reading lights 151
turn signal lever 147
- Lights range control 149
- Light switch 31
- Load compartment in the luggage compartment
see Loading the luggage compartment 160
- Loading the luggage compartment 160
- Loading the vehicle
fastening rings 162
luggage compartment 16
roof carrier system 165
- Locking and unlocking
in the door cylinder 15
with Keyless Access 135
with the central lock button 134
- Locking the front passenger door manually 16
- Luggage 160
- Luggage compartment 16, 160
luggage compartment light 151
luggage compartment variable floor 163
manual release mechanism 17
store the rear shelf 162
see also Loading the luggage compartment 160
- Luggage compartment floor 163
- Luggage compartment variable floor 163
- M**
- Main beam lever 147
- Maintenance intervals 266
- Malfunction
adaptive cruise control 217
catalytic converter 202
clutch 196
diesel particulate filter 202
emergency braking assistance system (Front Assist) 214
gearbox 196
- Manual air conditioning 171
- Manual gearbox 189
- MFD
see Driver information system 37
- Mobile 247
- Mobile telephones 247
- Multi-collision Brake 188
- Multi-function display (MFD) 37
- Multimedia 129
- My Beat 180
- N**
- Natural gas 260
fuel gauge 121
fuel tank cap 258
LNG 258
refuelling 258, 260

- smell 260
- special features 258
- Noises
 - adaptive cruise control 218
 - refuelling natural gas 258
 - tyres 69
- Number of seats 81
- O**
 - Odometer 120
 - reset button 120
 - total 117
 - trip recorder 117
 - Oil change 269
 - Oil properties 58
 - On-board computer
 - see Driver information system 37
 - One-touch opening and closing
 - electric windows 143
 - Opening
 - bonnet 17
 - fuel tank flap 257, 258
 - sunroof 144
 - windows 141
 - Opening and closing 130
 - bonnet 17
 - by remote control 130
 - fuel cap 57
 - fuel tank flap 257, 258
 - in the door cylinder 15
 - in the lock cylinder 15
 - rear lid 16, 141
 - sunroof 144
 - windows 141
 - with the central lock button 134
 - Operating malfunction
 - sunroof 144
- Outside temperature 41
- P**
 - Panoramic sliding sunroof
 - convenience opening and closing 143
 - see also Sunroof 144
 - Parking 182, 193
 - Parking aid 228
 - adjusting the display and audible warnings 232
 - parking aid plus 230
 - sensors and camera: cleaning 251
 - towing bracket 233
 - Parking Aid
 - automatic activation 231
 - braking while manoeuvring 233
 - malfunction 233
 - rear parking aid 229
 - visual indication 232
 - Parking aid system
 - see Parking aid 228, 230
 - Parking distance warning system
 - see Parking aid 228, 230
 - Parking (automatic gearbox) 193
 - ParkPilot
 - see Parking aid 228, 230
 - Parts 247
 - Passenger
 - see Correct sitting position 76, 77, 78
 - Passenger-side instrument panel
 - left-hand drive 12
 - right-hand drive 13
 - Pedals 80
 - Petrol
 - additives 258
 - refuelling 258
 - Plastic parts: cleaning 251, 254
 - Pollution filter 166
 - Positioning seat belts
 - during pregnancy 85
 - seat belts 85
 - Power-assisted steering 199
 - Power steering 197
 - Pre-heating system
 - control lamp 203
 - Preheating the engine 179
 - Press & Drive
 - starter button 178
 - starting the engine 179
 - Products for vehicle maintenance 248
 - Puncture
 - action 63
- R**
 - Radar sensor 214, 219
 - Radio screen: cleaning 254
 - Radio transmitters 247
 - Raising the vehicle 68
 - Rear Assist 234
 - instructions for use 235
 - parking 236
 - screen 235
 - special characteristics 235
 - Rear Assist system 234
 - Rear fog light
 - control lamp 146
 - Rear lid 16, 17, 141
 - Rear lights
 - access 110
 - replacement 110
 - Rear seat passengers
 - see Correct sitting position 76, 77, 78
 - Rear shelf
 - store 162
 - Rear View Camera 234

- Rear view mirrors 152
- Rear window wiper blades
 - changing 74
 - cleaning 74
- Refuelling 257
 - fuel gauge 121
 - gas gauge 121
 - natural gas 258
 - opening the fuel tank flap 257
- Remote control 130
- Removing and attaching head restraints 155
- Repair work 247
- Replacement
 - parts 247
- Replacement keys 130
- Replacement parts 247
- Replacing the battery
 - of the vehicle key 131
- Reset the trip recorder 120
- Reverse gear (automatic gearbox) 190
- Revolution counter 117, 118
- Rims
 - changing a wheel 65
- Roll-back function
 - windows 142
- RON (petrol) 258
- Roof carrier 164
- Roof carrier system 164
- Roof load 165
 - technical data 165
- Roof luggage rack
 - attach the cross bars 165
- Roof rack 164
- Rubber seals
 - care 252
- Run-in 274
- Running in
 - brake pads 199
 - engine 199
 - tyres 199
- S**
- Safe 133
- SAFE 177
- Safe driving 75
- Safe Security system 133
- Safety
 - child safety 92
 - child seats 92
 - deactivating the front passenger airbag 22
 - safe driving 75
- Safety equipment 75
- Safety instructions
 - belt tensioners 85
 - coolant temperature 270
 - front airbags 88
 - head-protection airbags 23
 - side airbags 88
 - use of seat belts 82
 - using child seats 24, 92
- Saving fuel
 - inertia mode 195
- Saving tips (efficiency program) 42
- Seat
 - heating 156
- Seat belt position
 - for pregnant women 19
 - seat belts 19
- Seat belts
 - adjustment 19, 84
 - control lamp 81
 - protective function 82
 - purpose 81, 86
 - safety instructions 82
 - unfastened 83
- Seat belt tensioners 20, 85
- SEAT Drive Profile 225
- Seat heating 156
- Selective catalytic reduction
 - see Exhaust purification system (diesel) 261
- Selective opening 133
- Selector lever lock 191
- Selector lever (automatic gearbox)
 - malfunction 191
 - manual release mechanism 50
 - positions 190
- Service intervals 43
- Service notification: read 44
- Side airbags
 - description 22
 - safety instructions 88
- Signal lever 32
- Sliding sunroof 18
- Smell of gas 260
- Snow chains 70, 283
- Spanner symbol 43
- Spare wheel 279
- Special characteristics
 - tow-starting 101
- Speed limiter 209
 - control lamp 209
 - display message 209
 - operate 210
 - warning lamp 209
- Speed warning 42
- Speed warning device 42
- Sport Mode 185
- Start-Stop 204

- Start-Stop system
 driver messages 207
 lamps 205
 operation 204
 starting and stopping the engine 205
 switching off and on 207
- Start-Stop System
 the engine does not switch off 206
 the engine starts by itself 206
- Starter button 178
- Starting the engine 175, 176
 after the fuel tank has run dry 176
 diesel 176
 petrol 175
- Starting the vehicle 31
- Steel wheel rims
 cleaning 253
- Steering 77, 197
 control lamp 198
 electromechanical 199
 power 199
 power-assisted steering 199
 steering column lock 198
- Steering wheel
 adjustment 20
 gear shift paddles (automatic gearbox) 192
- Steering wheel controls 124
- Steering wheel height adjustment 77
- Storage compartment
 of front door panel 159
 on the front passenger side 158
 right front seat 158
 storage pocket in the seat 159
- Storage compartments 158
- Sun blinds
 Anti-trap function (sunroof) 145
 sliding sunroof 145
- Sunroof 144
 anti-trap function 145
 closing 144
 opening 144
 operating malfunction 144
- Sun visors 151
- Switch
 hazard warning lights 150
 Switching off the engine 177
 Switching off the lights 146
 Switching on the lights 146
 Switching the ignition on and off 31, 175
- T**
- Tail light bulbs 109
- Tail lights
 summary 109
- Taking care of your vehicle
 interior 254
- Technical data
 roof load 165
- Technical modifications 247
- Technical specifications 281
- Temperature display
 engine oil 42
 outside temperature 41
- Temporary spare wheel 279
- Textiles: cleaning 254
- Tightening torque
 wheel bolts 69
- Tightening torque of wheel bolts 283
- Tiptronic (automatic gearbox) 190, 192
- Top speed 42
- Top Tether 27, 30
- Top Tether system 27, 30
- Tow-starting 71, 100
- Tow-starting the engine 101
- Towing a trailer 242
- Towing bracket
 retrofitting 245
- Towing bracket device 237
 ball coupling 243
 description 237
- Towing device bracket
 operation and care 241
- Towing the vehicle 70, 100
- Towline anchorages 70
 rear 102
- Tow rope 242
- Traction control system 183, 184, 185
 control lamp 184
- Trailer 237
 connecting 243, 244
 driving with a trailer 244
 electrical socket 243
 hitching 243
 mode 282
 parking aid 233
 rear lights 242
 safety lug 244
 tow rope 242
- Trailer turn signals
 control lamp 148
- Trailer weights 282
- Transporting children 92
- Transporting items
 fastening rings 162
 roof carrier 164
 roof carrier system 164
- Transporting objects
 roof carrier system 165
- Turn signal lever 147
- Turn signals
 control lamp 148

Tyre Mobility Set	64
components	99
inflating a tyre	99
sealing a tyre	99
Tyre Mobility System	
<i>see</i> Anti-puncture kit	98
Tyre pressure	276, 283
Tyre profile	276
Tyre repair	98
Tyre repair kit	
<i>see</i> Anti-puncture kit	98
Tyres	274
changing	65
new tyres	277
pressure	275, 276, 278
service life	276
wear indicators	276
with directional tread	69
with directional tread pattern	275
Tyre tread depth	276
Tyre wear	276

U

Unfastening your seat belt	84
Unfasten the seat belt	19
Unlocking and locking	
by remote control	130
with Keyless Access	135
with the central lock button	134
Unlocking manually	
rear lid	17
Upholstery: cleaning	
alcantara	256
upholstery	254
USB	129
USB/AUX-IN Port	129

V

Vanity mirror	151
Vehicle	
data label	281
identification data	281
identification number	281
raising	68
unlocking and locking with Keyless Access ..	135
vehicle identification number	281
Vehicle battery	60, 272
assisted starting	71
changing	274
charging	274
connecting and disconnecting	272
disconnect and connect	44
electrolyte level	273
winter conditions	272
Vehicle care	
windscreen wipers service position	73
Vehicle documentation compartment	158
Vehicle interior monitoring and anti-tow system	140
activation	139
Vehicle paint	
code	282
Vehicle paintwork	
maintenance	251
polishing	251
products for vehicle maintenance	248
Vehicle seats	81
Vehicle tools	65
housing	97
Vehicle underbody	
protection	253
Vehicle washing	249
Ventilation	170
Ventilation slits	161

W

Warning and control lamps	122
adaptive cruise control	218
airbags	90
applying the brake	218
audible warning signal	122
engine management	203
engine pre-heating/fault system	203
gear change	196
instrument panel display	48
seat belt	81
Start-Stop	205
Warning messages	
red	122
yellow	122
Warning symbols	122
<i>see also</i> Control and warning lamps	122
Warning triangle	150
Washing	
care of the vehicle exterior	249
washing the vehicle	249
adhesive sheets	250
high pressure cleaners	250
Weights	282
What negatively affects driving safety?	75
Wheel balance	276
Wheel bolts	67, 283
anti-theft	67
caps	66
tightening torque	69, 278
Wheel cover	66
Wheels	274, 283
central wheel trim	65, 66
chains	283
changing	65
new wheels	277
removing and fitting	68

snow chains	70
wheel cover	66
Wheel trim	
removing	66
Windows	
electric	18, 141
removing ice	251
Window wiper	152
Window wiper blade	33
Windscreen and rear window wiper blades	100
Windscreen defrosting	170
Windscreen washer	60, 152
Windscreen washer water	
checking	272
filling amounts	272
topping up	272
Windscreen wiper blades	
cleaning	252
service position	73
Windscreen wipers	33, 152
lifting the wiper blade	73
replacing the wiper blade	73
service position	73
Winter conditions	
battery	272
diesel	260
snow chains	70
thawing windows	251
tyres	280
Winter driving	
sunroof	144
Winter tyres	
sizes	280
Wireless Charger	129
X	
XDS	188

SEAT S.A. is permanently concerned about continuous development of its types and models. For this reason we ask you to understand, that at any given time, changes regarding shape, equipment and technique may take place on the car delivered. For this reason no right at all may derive based on the data, drawings and descriptions in this current handbook.

All texts, illustrations and standards in this handbook are based on the status of information at the time of printing. Except for error or omission, the information included in the current handbook is valid as of the date of closing print.

Re-printing, copying or translating, whether total or partial is not allowed unless SEAT allows it in written form.

SEAT reserves all rights in accordance with the "Copyright" Act.

All rights on changes are reserved.

 This paper has been manufactured using bleached non-chlorine cellulose.

© SEAT S.A. - Reprint: 15.11.17

Inglés 6F0012720BC (1.1.17)



6F0012720BC



SEAT recommends
SEAT **GENUINE OIL**



SEAT recommends
Castrol EDGE Professional