



SEAT

**MEDIA SYSTEM PLUS
NAVI SYSTEM
NAVI SYSTEM PLUS**

LEON

Owner's manual



About this manual

This manual contains information, recommendations, advice and warnings related to your radio system. The other publications in the vehicle documentation contain further information of which you should be aware for your own safety and for that of your passengers.

Ensure that the onboard documentation is kept in the vehicle at all times. This is especially important when lending or selling the vehicle to another person.

This manual contains a description of the **equipment** supplied with the vehicle at the time of press. Some of the units described herein will not be available until a later date or is only available in certain markets.

The **illustrations** are intended as a general guide and may vary from the equipment fitted in your vehicle in some details.

The **screen colour** and the colour of the information displayed on it can vary according to vehicle model.

Directions and positions of components (e.g. right, left, front, rear) are always relative to the direction of travel of the vehicle unless otherwise stated.

The **audiovisual material** only is intended to help users to understand certain car functionalities better. It does not replace the instruction manual. Please use the instruction manual to obtain more comprehensive information and indications.

✱ The **equipment marked with an asterisk*** is fitted as standard only in certain versions, and is only supplied as optional extras for some versions, or are only offered in certain countries.

® All **registered marks** are indicated with ®. Although the copyright symbol does not appear, it is a copyrighted mark.

» The section is continued on the following page.

WARNING

Texts preceded by this symbol contain information on safety. They warn you about possible dangers of accident or injury.

CAUTION

Texts with this symbol draw your attention to potential sources of damage to your vehicle.

For the sake of the environment

Texts preceded by this symbol contain relevant information concerning environmental protection.

Note

Texts preceded by this symbol contain additional information.

Related videos



General instructions and settings » page 8



Radio mode » page 29



Media mode » page 37



Navigation » page 56



Telephone management system (PHONE) » page 77



Connectivity » page 17

Table of Contents

Overview	4	Setup	90
Unit overview	4	Menu and system settings	90
Main menus	5	Sound and volume settings	91
Introduction	7	Other important information	93
Safety instructions relating to the Infotainment system	7	Legal information	93
General instructions for use	8	Abbreviations	93
Voice control	13	Index	95
Connectivity	17		
Data transfer	17		
Related video	17		
Full Link*	17		
SEAT Media Control	26		
WLAN hotspot	26		
Audio and Media Mode	29		
Radio Mode	29		
Media mode	37		
Navigation	56		
Navigation, entry and control	56		
Navigation settings	67		
Navigation in Offroad mode*	69		
CAR menu	72		
Introduction to managing the CAR menu	72		
Telephone management system (PHONE)	77		
Introduction to the telephone management system	77		
Description of the telephone management system	80		

Overview

Unit overview



Fig. 1 Overview of the controls

① » page 8

② » page 17^{a)}

③ » page 9

④ » page 10

^{a)} If your vehicle does not have Full Link*, pressing the key will bring up a message on the screen telling you that you can activate this function in an Official Service of your choice.

Main menus

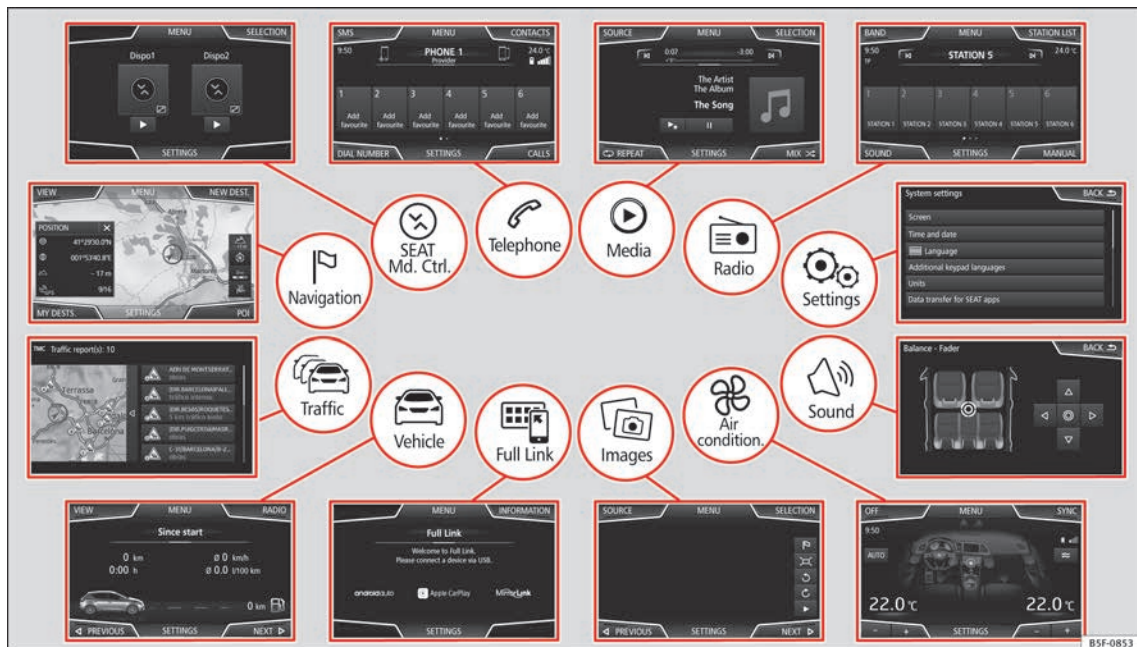



Fig. 2 Summary of the menus.



 **Radio** » page 29

RADIO main menu » page 29
 RDS radio data services » page 30
 Digital radio mode » page 31
 Memory buttons » page 32
 Storing station logos » page 33
 Select, tune and store stations » page 33
 Scan function » page 34
 TP traffic news » page 34
 Settings » page 35

 **Media** » page 37

Data and file storage devices » page 37
 Playing order » page 40 » page 40
 Changing the media source » page 42
 Changing tracks » page 43
 Selecting an album by its cover » page 44
 Selecting of a track from a list of tracks » page 44
 Database view » page 45
 Inserting or ejecting a CD » page 46
 Memory card » page 46
 External data storage device connected to the USB port » page 47
 External audio source connected to the AUX-IN multimedia socket » page 48
 External audio source with Bluetooth® » page 48
 Images » page 54
 Settings » page 53 » page 54

 **Telephone** » page 77

Pairing » page 79
 Bluetooth® » page 78
 Function buttons » page 81
 Entering a number » page 83
 Phonebook » page 84
 Short messages (SMS) » page 85
 Call list » page 86
 Speed dial buttons » page 86
 Settings » page 87

 **Navigation** » page 56

New destination » page 58
 Route options » page 59 » page 60
 My destinations » page 60
 Points of interest (POI) » page 62
 View » page 63
 Split screen » page 63
 Map display » page 64
 Traffic reports and dynamic route guidance to the destination (TRAFFIC) » page 64
 Predictive navigation » page 65
 Importing vCards » page 66
 Importing Personal POI » page 66
 Navigation with images » page 66
 Traffic signs » page 67
 Route guidance in Demo mode » page 67
 Settings » page 67
 Offroad mode » page 69

 **Traffic** » page 64



Traffic information (TP) » page 34
 Traffic reports and dynamic route guidance to the destination (TRAFFIC) » page 64

 **Vehicle** » Booklet Instruction Manual

Sport » page 72
 Offroad » page 73
 Consumers » page 73
 Driving data » page 73
 Ecotrainer » page 74
 Vehicle status » page 75

 **Full Link** » page 17

Requirements » page 19
 Activation of Full Link » page 20
 Pairing portable devices » page 21
 MirrorLink® » page 22
 Apple CarPlay™ » page 23
 Android Auto™ » page 23
 Frequently asked questions » page 25

 **Images** » page 54 **Sound** » page 91 **Air condition** » Booklet Instruction Manual **Settings** » page 90

Introduction

Safety instructions relating to the Infotainment system

Travelling on today's roads requires the driver's full attention at all times.

Only operate the radio and its various functions when the traffic situation really permits this.

WARNING

- Before starting the trip, you should familiarise yourself with the different radio functions.
- High audio volume may represent a danger to you and to others.
- Adjust the volume in a way that you can distinguish surrounding noise, for example, horns and sirens, etc.
- Changes to the Infotainment system settings should be made when the car is stopped, or by a passenger.

WARNING

Distracting the driver in any way can lead to an accident and cause injuries. Operating the Infotainment system can distract your attention from the traffic.

- Always drive carefully and responsibly.

- Select volume settings that allow you to easily hear signals from outside the vehicle at all times (e.g. emergency services sirens and horns).
- Hearing may be impaired if using too high a volume setting, even if only for short periods of time.

WARNING

The volume level may suddenly change when you switch audio source or connect a new audio source.

- Lower the base volume before connecting or switching audio sources.

WARNING

The driving recommendations and traffic indications shown on the navigation system may differ from the current traffic situation.

- Traffic signs and traffic regulations have priority over the recommendations and displays provided by the navigation system.
- Adjust your vehicle speed and driving style to suit visibility, weather, road and traffic conditions.

WARNING

Connecting, inserting or removing a data medium while driving can distract your attention from the traffic and cause an accident.

WARNING

Connecting leads for external devices may obstruct the driver.

- Arrange the connecting leads so that they do not obstruct the driver.

WARNING

External devices that are loose or not properly secured could move around the passenger compartment during a sudden driving or braking manoeuvre or an accident and cause damage or injury.

- Never place or fit external devices to the doors, windscreen, steering wheel, dash panel, the backs of the seats, on top of or near the area marked "AIRBAG" or between these areas and the occupants. External devices can cause serious injury in an accident, especially when the airbags inflate.

WARNING

The armrest may obstruct the driver's arm movements, which could cause an accident and severe injuries.

- Always keep the armrest closed while the vehicle is in motion.

WARNING

Opening a CD or DVD player's housing can lead to injuries from invisible laser radiation.

- Have CD or DVD players repaired only by a qualified workshop.

ⓘ CAUTION

The Infotainment system can be damaged by the incorrect insertion of a data storage device or the insertion of an incompatible data storage device.

- When inserting a data storage device, make sure it is correctly positioned » page 37.
- Applying force may irreparably damage the memory card slot locking mechanism.
- Only use compatible memory cards.
- When inserting and removing CDs and DVDs, always hold them at right angles to the front of the CD/DVD drive without tilting so as not to scratch them.
- If a CD or DVD is inserted while another is already in the unit or being ejected, the DVD drive may be irreparably damaged. Always wait until the data medium is completely ejected.

ⓘ CAUTION

Any foreign objects stuck to a data storage device and non-round media may damage the CD or DVD player.

- Only clean, standard 12 cm CDs or DVDs should be used.
 - Do not affix stickers or other items to the data medium. Stickers may peel off and damage the drive.
 - Do not use printable data media. Printed labels and coverings may peel off and damage the CD/DVD drive.

- Do not insert 8 cm single CDs or irregularly shaped CDs or DVDs.
- Do not insert DVD-Plus discs, Dual Discs or Flip Discs, as these are thicker than normal CDs.

ⓘ CAUTION

The vehicle loudspeakers may be damaged if the volume is too high or the sound is distorted.

General instructions for use

Related video



Fig. 3 General instructions and settings

Introduction

If the setup is changed, this may change the display on the screen and in some cases, the Infotainment system may behave in a manner different to that described in this manual.

ⓘ Note

- Lightly pressing the buttons or briefly pressing the touchscreen is sufficient to operate the Infotainment system.
- Not all listed function buttons and functions described may be available due to the device software used in your market. The equipment is not faulty if a function button is missing from the screen.
- Due to country-specific legislation, certain functions may not be available on the screen when the vehicle is travelling above a certain speed.
- Using a mobile telephone in the vehicle may cause noise from the vehicle loudspeakers.
- Restrictions on the use of devices using Bluetooth® technology may apply in some countries. For further information, contact the local authorities.
- On some vehicles with ParkPilot, the volume of the audio source is automatically lowered when reverse gear is selected. You can change settings for lowering the volume in the Sound setup menu » page 91.

Diagram of the menus

The Infotainment system touchscreen » **Fig. 1** (4) can be used to select the different main menus.

Press the infotainment (MENU) button »» Fig. 1 ① to open the menu summary »» page 5.

The display of the touchscreen's main menu »» Fig. 1 ④ can be switched between "grid" and "carousel" via the Settings menu »» page 90.

Infotainment system rotary knobs and buttons



Fig. 4 Main menu

Rotary/push knobs

The rotary knob ① »» Fig. 1 ③ is the volume control or the on/off button.

Infotainment buttons

The buttons on the unit are shown in this manual with the word "Infotainment button" and their function within a rectangle, for example, (MENU) Infotainment button.

The Infotainment buttons are used by *pressing them or pressing and holding*.

Note

- There may be more icons on the second page, depending on the infotainment version. In this case, to see the other icons press the function button »» Fig. 4 (arrow) or swipe your finger horizontally across the screen.

Switch on and Switch off

To manually switch the Infotainment system on and off, briefly *press* the rotary knob ① »» Fig. 1 ③.

When switching on, the system starts-up with the last set volume, provided that this does not exceed the preset maximum start-up volume »» page 91, **Sound and volume settings**.

The unit will switch off automatically when the key is removed from the ignition or when the on/off button is pressed (depending on the equipment fitted or the vehicle). If the Infotainment system is switched on again, it will switch off automatically after approximately 30 minutes (switch-off delay).

Note

- The Infotainment system is a part of the vehicle. It cannot be used in any other vehicle.

- If the battery has been disconnected, the ignition must be activated before switching on the Infotainment system.

Change base volume

Increasing or decreasing the volume or muting the sound

Increasing the volume: Turn the volume control ① clockwise or move the left thumbwheel on the multifunction steering wheel upward Δ »» **Booklet Instruction Manual**.

Lowering the volume: Turn the volume control ① anti-clockwise or move the left thumbwheel on the multifunction steering wheel downward ▽ »» **Booklet Instruction Manual**.

Changes in volume are indicated by a volume bar on the screen. The volume can be controlled using the steering wheel controls. In this case, the changes in volume are displayed on the instrument panel by a volume bar.

It is possible to preset certain volume settings and adjustments »» page 91, **Sound and volume settings**.

Muting the Infotainment system sound

- Turn the volume control ① anti-clockwise until it displays ④. »»

Muting the Infotainment system sound stops the media source that is playing. The screen displays .

Note

If the base volume has been considerably increased to play a certain audio source, lower the volume again before switching to another audio source.

Operation of the function buttons and the instructions on the screen

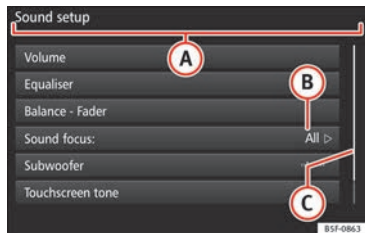

Fig. 5 View of some of the function buttons on the screen.

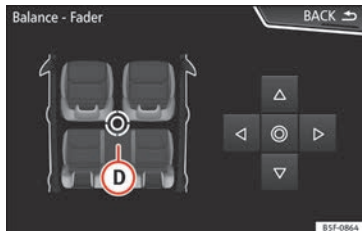





Fig. 6 Sound setup menu

The Infotainment system comes equipped with a touchscreen  page 4  4.

Active areas of the screen that call up a certain function are called “function buttons”. These buttons are operated by *briefly pressing* the screen or by *pressing and holding*.

The function buttons appear in the instructions with the label “function button” and a button symbol (inside a rectangle).

Function buttons start functions or open sub-menus. The currently selected menu is displayed in the title bar  Fig. 5  B of the sub-menus.

Inactive (grey) function buttons cannot be selected.









Increase or decrease the size of the images displayed on the screen

The size of the navigation map image  page 56 and, for example, photos when

viewing images  page 37 can be enlarged or reduced. To do so, enlarge or reduce the image displayed by moving two fingers.

Overview of screen and function buttons

Display and function buttons: operation and effect

-  The title bar shows the selected menu and, where applicable, other function buttons.
-  Press it to open another menu.
-  The scroll bar is shown on the right and its size depends on the entries in the list. Move the bar on the screen by pressing lightly and without lifting the finger, see  page 11, Open list entries and search lists.
-  **Movable cursor:** Move the cursor around the screen by pressing lightly and without lifting the finger.
OR: To move the cursor to a particular position, press that spot on the screen.
-  **Fixed crosshair:** Press the up, down, left and right arrows to move the sound according to preference. The cursor  will move.
OR: Press the central button to centre the stereo sound in the centre of the passenger compartment
-  Press it on some lists to move up a level, one by one.

Display and function buttons: operation and effect

BACK ↩ Press to return from the submenus one at a time to the main menu or to undo the entries made.

▽ When pressed, a pop-up window opens (options window) which displays other setup options.

☑ / ☐ Some functions or messages are accompanied by a check box and are activated ☑ or deactivated ☐ by pressing said check box.

OK Press to confirm an entry or a selection.

✕ Press to close a pop-up window or an input window.

+ / - Press them to change the setup adjustments one at a time.

☐ Move the slider around the screen by pressing it lightly and without lifting your finger.

Open list entries and search lists

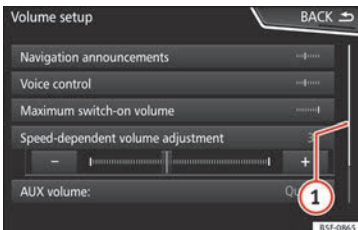

Fig. 7 Entries on a setup menu list.

The entries on the lists can be activated by pressing them on the screen directly.

Mark list entries using the setup button and open them

- Turn the setup button to mark the entries on the list with a rectangle one by one and continue searching the list in this manner.
- Press the setup button to activate the marked entry on the list.

Search lists (scrolling the screen)

The scroll bar is shown on the right and its size depends on the entries in the list

» Fig. 7 ①.

- Briefly press the screen above or below the scroll marker.

- **OR:** Place a finger over the scroll marker and *without lifting it*, move it around the screen. Lift your finger off the screen when you reach the desired position.
- **OR:** Place your finger in the centre of the screen and *without lifting it*, move it around the screen. Lift your finger off the screen when you reach the desired position.

Input masks with on-screen keypad



Fig. 8 Input window with on-screen keypad.

Input windows with on-screen keypad are used for functions such as entering an entry name, selecting a destination address or entering a search term for searching long lists.

The function buttons listed below are not available in all countries or for all topics.

Subsequent chapters only explain those functions that differ from those in the screen shown in the figure. »

The input line with cursor is located in the top bar of the screen. All inputs are displayed here.

Input windows for “free text input”

In the input masks for open text, you may enter letters, numbers and special characters in any combination.

Input windows for selecting a saved entry (e.g. selection of a destination address)

It is only possible to select a sequence of letters, numbers and special characters that matches a stored entry.

Suggestions for matching destinations appear depending on the characters entered in the input line » Fig. 8 ④. In the case of compound names, it is necessary to enter a space.

If there are fewer than 99 selectable entries, the number of remaining entries is displayed after the input line ③. Pressing this function button displays these remaining entries in a list.

Overview of the function buttons

Icon and function text: operation and effect

Letters and digits Press them to copy them into the input line.

Icon and function text: operation and effect

- ① Press to change the keypad to another language. Keypad languages can be selected from the menu **system setup** » page 90.
- ② Press to show symbols on the keypad.
- ③ Displays the number and opens the list of remaining selectable entries that match the entered text.
- ④ Scroll bar, the size of which depends on the number of matching entries.
- ⑤ Hold and press to display a pop-up window with the special characters based on said letter. Press the desired character to enter it. Some special characters can be written out instead (e.g. “AE” for “Ä”).
- Press to enter a space.
- ✕ Press to delete characters in the input line from right to left.
Press and hold to delete several characters.
- BACK ↩ Press to close the input window.

Additional displays and display options

The displays appearing on the screen may vary depending on the settings, and may differ from those described here.

The status bar on the screen can display, for example, the current time and outside temperature.

All displays can be viewed only after completely restarting the Infotainment system.

Initial configuration wizard



Fig. 9 Initial configuration wizard

The initial configuration wizard will help you to set up your Infotainment system the first time you switch it on.

Every time you switch on the Infotainment system, the initial setup screen will appear » Fig. 9 if any parameters have not been set or if the **NEVER** function button has not been pressed.

Function button	Function
CLOSE	Closes the Configuration Wizard, and the main menu or last mode in which you used the Infotainment system will appear. The next time you switch on the system, the Configuration Wizard will start up again.
NEVER	Disables the possibility of changing the settings of the Infotainment system. If you want to perform the initial system setup, you must enter via System set-up and select Configuration Wizard » page 90.
START	Starts up the Configuration Wizard.
A	Press to configure the time and date (if it has a navigation system it will be configured automatically with the GPS).
B	Press to search and store to memory the radio stations that have the best reception at that moment.
C	Press to link your mobile telephone to the Infotainment system.
D ^{a)}	Press to select your home address using your current position or by manually entering an address.

Function button	Function
PREVIOUS	To go to the previous or next parameter to set.
NEXT	When a parameter has been set, the only way to reset it is from the main menu, clicking on it, and not using the Previous/Next buttons. When setting any parameter, a confirmation mark will appear on it <input checked="" type="checkbox"/> .
FINISH	Once one or more settings have been applied, click on this in the main menu of the wizard to confirm and finalize the settings. If there are any parameters you have not set, the next time you connect the Infotainment system, the Initial Configuration Wizard will start up.

^{a)} Only valid for Navi System and Navi System Plus.

Voice control

Operation

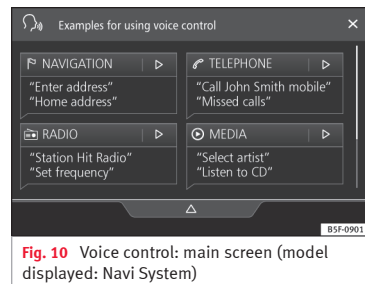



Fig. 10 Voice control: main screen (model displayed: Navi System)

Many radio, media, telephone and navigation functions may be performed through voice commands.

The Infotainment system's voice control will only be available for the language selected in System setup » page 90.

Setup of voice control » page 16.



Start and stop the voice control

- To activate the voice control, briefly press the button on the multi-function steering wheel .
- When you activate voice control, a tone will be heard for the start of the dialogue and the voice control main screen will be displayed, »

»» **Fig. 10**, (the main screen will appear in the format selected in Voice control settings »» page 16). The spoken instructions will guide you through the following “dialogue”.

- Pronounce the desired order and follow the instructions of the “dialogue”. A function can often be activated with different spoken commands. If in doubt, try giving a command or say **Help**.

- When an action is performed (e.g. calling a contact), the voice control automatically deactivates and must be reactivated again when needed. There are certain commands after which the voice control does not end and waits with **What do you wish to do now?**

- To finish voice control manually, either press and hold the  button on the multi-function steering wheel until the corresponding confirmation signal is heard, or give two quick presses on the  button on the steering wheel, or press the X function button in the top right corner of the screen.

- Voice control can also be ended by giving the following orders: **End Voice Control** or **Cancel**.

Help with voice control





Listening to Help when using voice control for the first time is recommended.

- Switch on the speech control system .

- Give the **Help** command in the language established in the **System setup**, and follow the dialogue instructions. The **Help** command can also be spoken followed by the infotainment system function, for example, **“Help with the navigation”**.

Interaction with the dialogue mode

Icons in the top left corner:

-  The system is expecting a command from the user.
-  The system has recognised a command and will act shortly.
-  The system is sending a spoken command and confirms the command given.
-  The system is in pause mode. (max. 3 minutes).
- △ / ▽ Hide or show the voice control menu
»» **Fig. 10**.

Operation during the dialogue

While the infotainment system transmits a spoken indication, the display will show the symbol .

- The announcement can be stopped by pressing the upper left icon on the screen or the  button on the steering wheel and voice recognition for the user will resume.

IMPORTANT: The system will ONLY recognise a command when the  symbol is displayed as “active” on the display or touch screen.

If you make a mistake when giving a command or give an incomplete command, and it has no effect, you can repeat the command. The symbol  remains active.

- Briefly press the  button to repeat the command.

Instructions for voice control

For optimum functioning of the voice control, follow these instructions:

- Speak slowly and clearly, as far as possible. The system will not recognise words that are not pronounced clearly, or words and figures in which syllables are omitted.
- Telephone numbers must be given digit by digit or in blocks of numbers in ones, tens or hundreds.
- Speak at a normal volume, without exaggerated intonation or long pauses.
- Avoid noise from the exterior and nearby (for example, conversations inside the vehicle). Close all doors, windows and the sliding roof.
- Do not aim the air from the diffusers at the roof of the passenger compartment.
- If you are driving very fast, speak a little louder.

When you activate voice control you are taken to the main screen »» Fig. 10 where the main commands and the modes in which system works are shown.

From here, you can tell the system which mode you want to activate or directly give a voice command.

When you select any of the modes (Navigation, Telephone, Radio, Media, Voice control) a menu will appear listing the main commands and, in each one, brief explanations to help understand how they work.

Voice control (RADIO)

LISTEN TO THE RADIO	Listen to the radio
SELECT STATION	Station NAME STATION 1
	Set station
SELECT FREQUENCY	Frequency 87.9
	Set frequency
CHANGING BANDS	Band FM
	Change band

Voice control (MEDIA)

SELECT A SOURCE	Play Jukebox ^{a)}
	Listen to CD
SELECTING MUSIC	Select track / album / artist / genre

PLAY MORE LIKE THIS^{a)}	Play more like this
---	---------------------

^{a)} Only available for the model: "Navi System Plus"

Voice control (PHONE)

CALL CONTACTS	Call Forename Surname Landline
	Call Forename Surname Mobile
CALL NUMBERS	Call 01234
	Call number
CALL LIST	Show all calls
	Missed calls
REDIAL	Redial
CALL MAILBOX	Call mailbox
SMS	Read out text message
SERVICE	Assistance call
INFORMATION	Information call

Voice control (NAV)*

ENTER AN ADDRESS	Enter address
	Navigate to City, Street, Number ^{a)}
SEARCH FOR POIS^{a)}	Nearest car park
	Search for restaurants near destination.

HOME ADDRESS	Home address
LAST DESTINATIONS	Last destinations
NAVIGATE TO CONTACTS	Navigate to Forename Surname
	Start route guidance
ROUTE GUIDANCE	Route information

^{a)} Only available for the model: "Navi System Plus"

Voice control

VOICE CONTROL	Pardon?
	Back
	Main menu
	Cancel voice control
HELP	Pause voice control
	Help
PUSH-TO-TALK	What can I say?

Note

Voice control is not possible during parking manoeuvres.

Voice control settings

- Press the infotainment **MENU** button » **Fig. 1** ① and then press the **Settings** context to open the **System settings** main menu.
- Press the function button **Settings** to access the system setup.
- Press the function button **Voice control**.

When you close a menu, the changes will take effect automatically.

Function button: function

Example commands (infotainment system): View voice command examples on the infotainment system screen.

Example commands (instrument cluster)^{a)}: View voice command examples on the instrument panel.

Voice control session start tone: when you activate voice control a signal will be emitted. Press to deactivate the signal.

Voice control session end tone: when you deactivate voice control a signal will be emitted. Press to deactivate the signal.

Input tone in voice dialogue: the input tone to confirm a command is activated.

End tone in voice dialogue: the end tone to confirm a command is deactivated.

^{a)} Available depending on equipment.

Connectivity

Data transfer

This communication can allow data to be read and/or written.

From the *SETTINGS* menu > *Data transfer for SEAT apps*, there is a checkbox to activate/deactivate the function and a dropdown menu called *Operation via apps* which controls the level of interaction between the apps and the system »» table on page 90.

Related video



B5F-0860

Fig. 11 Connectivity

Full Link*

Full Link technology description

The Full Link system provides a way of bringing together technologies that allow communication between the Infotainment System and mobile devices:

- MirrorLink®
- Android Auto™
- Apple CarPlay™

Interfaces

To access the Full Link system, press the Full Link button »» Fig. 1 ② or press the infotainment (MENU) button »» Fig. 1 ① and then select the **Full Link** context.

The connection to Full Link is made through a USB interface.

⚠ WARNING

If a mobile terminal is not secured or is incorrectly secured in the vehicle, it could move around the passenger compartment in the event of a sudden driving manoeuvre, emergency stop or accident, resulting in injury.

- While driving, mobile terminals must be securely fastened in position, outside the air-bag deployment zones, or safely stowed away.

⚠ WARNING

Any applications that are not suitable or execute incorrectly may cause damage to the vehicle, accidents and serious injuries.

- SEAT recommends the use of the Apps that SEAT provides for this vehicle.

- To make full use of SEAT Apps, you must activate the option Set up, "Data transfer for SEAT apps" »» page 90.

- The interaction level of the Apps on the system must be: ALLOW.
- Protect the mobile terminal with its applications from improper use.
- Never make modifications to the applications.
- Consult the instruction manual for the mobile terminal.

⚠ WARNING

The use of applications while driving can distract your attention from the traffic. Distracting the driver in any way can lead to an accident and cause injuries.

- Always drive carefully and responsibly.

ⓘ CAUTION

• In areas where special regulations apply or the use of mobile terminals is forbidden, the mobile terminal must be switched off at all times. The radiation produced by the mobile terminal when switched on may interfere with sensitive technical and medical equipment, possibly resulting in malfunction or damage to the equipment.

- SEAT cannot be held liable for any damage caused to the vehicle as a result of the use of applications that are of poor quality or are defective, the inadequate programming of



the applications, the insufficient coverage of the network, the loss of data during transmission or the improper use of mobile terminals.

Note

- Use of Full Link technology may result in high consumption of your 3G/4G data plan.
- SEAT recommends having a high battery charge on the device when connected to Full Link.
- SEAT recommends that to use Full Link, the “Date and time” should be correctly configured »» page 90.
- SEAT applications are designed to communicate with the vehicle and interact with it via the Full Link connection, therefore its functionality is linked to the mobile device being connected via USB.
- You can find further information on the technical requirements, compatible devices, suitable applications and availability at www.seat.com or at SEAT dealers.

Is Full Link blocked?

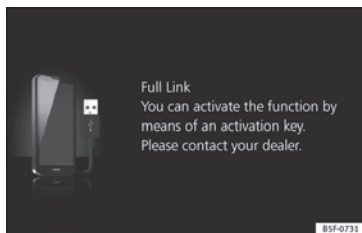

Fig. 12 Message on Infotainment system screen.

To unblock this feature, you must obtain the accessory from your SEAT dealer. Otherwise, a message like this will appear on the screen whenever you select the feature »» **Fig. 12**.

Requirements for Full Link



Fig. 13 Full Link Requirements

A

Full Link Activated: If you do not have Full Link in your vehicle you can acquire it as an accessory at your Authorised Service.

B

Compatible Phones. Go to the MirrorLink®, Android Auto™ or Apple CarPlay™ websites to confirm whether your phone is compatible with the system.

- Check smartphone compatibility: www.mirrorlink.com/phones
- MirrorLink® 1.1 or higher
- Some of the apps certified by SEAT or the CCC must be installed on the device.

- Check smartphone compatibility. Android Auto™: www.android.com/auto/
- Android 5.0 (Lollipop) or higher
- Install Android Auto™ app

Apple CarPlay

- Check smartphone compatibility. Apple CarPlay™: www.apple.com/ios/carplay/
- iPhone 5 or higher and iOS 7.1 or higher
- Turn on the SIRI personal assistant (see phone settings)

C

USB cable connecting car to phone: use the USB cable approved and supplied by the phone's official distributor.

Activation of Full Link

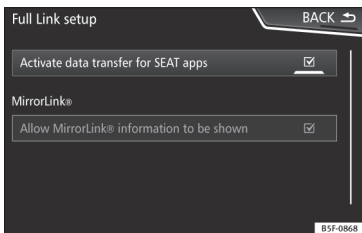

Fig. 14 Full Link Setup



Fig. 15 Full Link menu

Data connection via Wi-Fi or SIM is not necessary to establish the connection between the smartphone and Full Link.

Data connection via Wi-Fi or SIM is necessary to enable all of the app features¹⁾.

Proceed as follows to use Full Link:

- Switch on the Infotainment system
- Connect the smartphone to the vehicle's USB port using a USB cable » **Booklet Instruction Manual.**
- In the main menu for the Full Link setup, select **Activate data transfer for SEAT apps** » **Fig. 14:**

Finally, a message will appear stating that data transfer will commence when the device is connected. Please note that data is transferred over connections between your vehicle and mobile device. Press **OK**. Once selected, the technology compatible with your device can be used.

Note

Depending on your smartphone, it may have to be unlocked for the connection to occur.

What should I do if it does not connect?

Restart the mobile device

Check the USB cable visually.

Make sure that the USB cable is not damaged. Check that both connections (USB/micro USB) are not damaged or worn.

Visually check that the USB ports are properly connected.

Check that the vehicle and device USB connections are not damaged and/or worn.

Clean the USB ports (device and vehicle).

Try another compatible mobile device.

Have the USB port replaced at a SEAT Authorised Service.

Have the mobile device repaired or replace it.

Try another compatible mobile device.

¹⁾ Using the data connection to transfer the smartphone apps to Full Link may involve additional charges. Please check the charges with your operator.

Pairing of portable devices supporting the MirrorLink®, Android Auto™ and/or Apple CarPlay™ technologies



Fig. 16 Full Link menu

Carousel

When you enter the Full Link context for the first time, the technologies available for pairing the portable device are displayed.

Once the device connects via USB, the system will offer you the technologies available for establishing a connection with your mobile phone.

In the event of simultaneous connections between two devices with different operating systems, a choice will be presented for which one to make the connection with »» Fig. 16.

¹⁾ Unless the device requires the screen to be unlocked in order to establish the connection.

View of the device list

iPhone™ devices only support Apple CarPlay™.

There are some Android devices that support MirrorLink® and Android Auto™.

Bear in mind that once the device is connected it will not be available as an audio source.

Full Link setup

Function button: function

Data transfer for SEAT apps): allows the exchange of information between the vehicle and applications authorised by SEAT.

Last Mode

If a session using one technology ends without the disconnection being made from the Infotainment system (simply by disconnecting the cable) then when the device is next connected to it, the session will start without the user being required to take any action¹⁾.

Information

Consult the mobile device manual.

Depends on each technology:

1. Availability in a country
2. Third party applications

For further information:

MirrorLink®:
www.mirrorlink.com

Apple CarPlay™:
www.apple.com/ios/carplay

Android Auto™:
www.android.com/auto

i Note

- **In order to use Android Auto™ technology it is necessary to download the Android Auto™ application, located on Google Play™.**
- **Only compatible applications can be used, in accordance with the technology connected.**

MirrorLink®



Fig. 17 Function buttons in the general view of compatible applications.

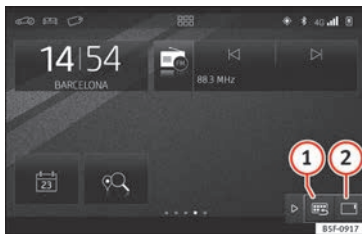

Fig. 18 Other MirrorLink function buttons.

MirrorLink® is a protocol which enables communication between a portable device and the Infotainment system via USB.

Using it makes it possible to display and manage the content and functions displayed

on the portable device on the Infotainment system screen.

To avoid distracting the driver while driving, only specially adapted applications can be used **»»** **△** in Full Link technology description on page 17.

Requirements

In order to use MirrorLink®, the following requirements must be met:

- The mobile device must be compatible with MirrorLink®.
- The mobile device must be connected to the Infotainment system via USB.
- Depending on the mobile device used, a suitable application must be installed for the use of MirrorLink® on the device.

Initiating the connection

- In order to initiate the connection with the mobile device, it is simply necessary to connect it to the Infotainment system via the USB connection.
- A pop-up screen will appear, which will request that you accept the device.

Function buttons and possible messages

Function button: function

Full Link	To return to the Full Link main menu.
------------------	---------------------------------------

Function button: function

CLOSE APPS	Press to close the open apps. Then press the apps to be closed or the (Close all) function button to close all the open applications.
1 : 1	Press to change to the mobile device screen.
SETTINGS	To open the Full Link setup
»» Fig. 18 ①	Press to return to the MirrorLink® main menu.
»» Fig. 18 ②	Press to display all the function buttons in the lower or upper right-hand margin of the screen.
»» Fig. 18 △ / ▷	Allows buttons ① and ② to be hidden or shown.
»» Fig. 1 ⑫	

MirrorLink® setup

Function button: function

Activate MirrorLink pop-up windows: Allows MirrorLink® pop-up windows in applications that support it.

Apple CarPlay™

✓ Valid for compatible iPhone™ mobile telephones. Also, iPhone™ mobile telephones only support Apple CarPlay™

Apple CarPlay™ is a protocol which enables communication between a mobile telephone and the Infotainment system via USB.

This makes it possible to display and operate the mobile telephone on the Infotainment system screen.

Requirements

In order to use Apple CarPlay™, the following requirements must be met:

- Make sure that you do not have Apple CarPlay™ restricted on your device, at: Settings > General > Restrictions > CarPlay > ON.
- The mobile device must be compatible with Apple CarPlay™.
- The mobile device must be connected to the Infotainment system via USB.

Initiating the connection

In order to initiate the connection with the mobile device, it is simply necessary to connect it to the Infotainment system via the USB connection.

- A pop-up screen will appear, which will request that you accept the device.

- If you start the session using Apple CarPlay™ technology, it will not be possible to pair another device via Bluetooth™. The following message will appear in the main **PHONE** menu:

Please disconnect Apple CarPlay first, before you can connect another mobile telephone.

Holding down the steering wheel multifunction  button or the **VOICE** button of the Infotainment system will start the Apple™ voice “engine”.

To return to the basic contents of the Infotainment system, press the **SEAT** icon.

Android Auto™

✓ Valid for compatible Android mobile phones.

Android Auto™ is a protocol which enables communication between a portable device and the Infotainment system via USB.

This makes it possible to display and operate the mobile telephone on the Infotainment system screen.

Requirements

In order to use Android Auto™, the following requirements must be met:

- The mobile device must be compatible with Android Auto™.

- The mobile device must be connected to the Infotainment system via USB.
- The Android Auto™ application should already be downloaded and installed on the mobile device.

Initiating the connection

In order to initiate the connection with the mobile device, it is simply necessary to connect it to the Infotainment system via the USB connection, and to be sure to follow the instructions of the device being paired.

- The first connection to Android Auto™ must be done while the vehicle is stationary.
- Once the first pop-up window about accepting data transfer between the car and the device has been accepted, a message will appear requesting that you check your mobile device for the confirmations needed to pair it with the Infotainment system.
- If you are initiating the session using Android Auto™ technology via USB, the mobile telephone connects automatically via Bluetooth™ to the Infotainment system telephone and it will not be possible to pair another mobile telephone via Bluetooth™.

Holding down the steering wheel multifunction  button or the **VOICE** button of the Infotainment system will start the Android™ voice “engine”.



To return to the basic contents of the Infotainment system, press the **Return to SEAT** button.

i Note

Some mobile devices require a change in the USB connection mode in order to use Android Auto™.

- Make sure that your mobile is in “Media Transfer Protocol (MTP)” mode before it is connected by USB to the Infotainment system.

i Note

Android Auto™ requires the use of Google™ services, as well as certain basic applications of the Android system.

- Make sure that you always have Google™ services updated in order to use this technology.

Frequently asked questions about Full Link

What is the connection method?	USB cable.
Will the USB cable be supplied with the vehicle?	No. The USB cable supplied with the device should be used.
Is navigation possible?	Navigation is possible in each one of the Full Link technologies if the technology is available in your country and if you have the Navigation app.
What is the difference between using the Full Link system navigator (via telephone) instead of another navigator?	Advantages: daily updates. Disadvantages: data consumption, reception problems.
Can I send voice messages?	With certified apps, such as SEAT ConnectApp, you can answer but not send.
What apps will be visible as I am driving?	Depending on the technology: – for MirrorLink®: apps certified by SEAT and the CCC, – for Android Auto™: the Apps selected by Google™, – for Apple CarPlay™: the Apps selected by Apple™.
Where can I find compatible Apps?	The compatible apps are shown at the following links: www.mirrorlink.com/ www.android.com/auto/ www.apple.com/ios/carplay/
Where can I download the apps?	From Google Play™ for Android Auto™/MirrorLink® and from the Apple Store™ for Apple CarPlay™.
If Full Link stops working, where can I have it repaired?	If the problem is in the car, you should go to the dealer. If the problem is in the mobile device, you should see your mobile telephone vendor.
Will WhatsApp be certified?	This depends on the technology.
Is MirrorLink® available in my country?	Yes, MirrorLink® is available in all the countries and regions where SEAT operates.
What are the differences between MirrorLink®, Android Auto™ and Apple CarPlay™?	MirrorLink® is not compatible with Android Auto™ and Apple CarPlay™, as they are different technologies. They all coexist in Full Link, although Android Auto™ is designed for mobile devices with the Android™ operating system, and Apple CarPlay™ for iPhone.
Can MirrorLink® be installed in a previous SEAT model?	No, that is not possible.
Where can I find more information about Full Link?	If in doubt, please refer to the <i>Innovation/Connectivity</i> sections of our website: www.seat.es or www.seat.com , or send your query to seat-respond@seat.es

SEAT Media Control

Introduction

✓ Only available for the model: Navi System Plus

The **SEAT Media Control**¹⁾ app can be used to remotely operate some partial functions in *Radio* mode, *Media* mode and *Navigation* mode. Information can be exchanged between a device and the Infotainment System.

Each one of the functions is operated by means of a Tablet or partially by means of a mobile phone.

Operating requirements:

- A tablet or mobile phone.
- The app must be available on the corresponding device.
- There must be a WLAN connection between the Infotainment System and the device
»» page 51.

Make sure that data transfer for apps is activated:

- From the *SETTINGS* menu > *Data transfer for SEAT apps*, there is a checkbox to activate/deactivate the function and a dropdown menu called *Operation via apps* which con-

trols the level of interaction between the app and the system »» table on page 90.

You can obtain information about technical requirements on the SEAT website or at SEAT dealerships.

Telephone functions are not part of the functions of this app.

Data transmission and control functions



Fig. 19 SEAT Media Control Main menu

The Infotainment System can be operated from other seats in the vehicle as follows, with the help of **SEAT Media Control**:

- Radio remote control.
- Multimedia playback remote control.

The following information can be exchanged between a device and the Infotainment System, depending on the country and the equipment:

- Navigation destinations.
- Traffic information.
- Social media contents.
- Audio transmission.
- Vehicle data.
- Location-specific information, for example, POIs.

WLAN hotspot

Introduction

✓ Only available for the model: Navi System Plus

The Infotainment System can be used as a WLAN hotspot to connect up to 8 WLAN devices »» page 27, **Configure WLAN hotspot**.

The Infotainment System can also use the WLAN hotspot of an external wireless device to provide Internet to the devices connected to the hotspot (WLAN client) »» page 27, **Configuring internet access**.

¹⁾ Availability depends on the country.

Note

- Data transmission may incur charges. Due to the high volume of data exchanged, SEAT recommends the use of a flat rate mobile phone deal for data transmission. Mobile phone operators can provide the relevant information.
- The exchange of data packages over the internet may generate additional costs, depending on your mobile phone rate, particularly if you are abroad (for example, roaming rates).

Configure WLAN hotspot

The Infotainment System can be used as a wireless hotspot to connect up to 8 wireless devices.

Establishing the connection with the wireless network (WLAN)

- Press the Infotainment *MENU* button and then press the *SETTINGS* menu.
- Activate the wireless network (WLAN) on the Infotainment System. To do so, press the *WLAN* function button.
- Activate the wireless network (WLAN) on the wireless device that is to be connected. If necessary, refer to the manufacturer's instruction manual.

- Activate the mobile device assignment on the Infotainment System. To do so, press the *Mobile hotspot* function button and activate the checkbox.
- Enter and confirm the network key displayed on the wireless device.

The following hotspot settings can also be made on the **Hotspot settings** menu:

Security level: WPA2 encryption automatically generates a network key.

Network key: Network key automatically generated. Press the function button to manually change the network key. The network key must have a minimum of 8 characters and a maximum of 63.

SSID: WLAN Network name (maximum of 32 characters).

Do not send network name (SSID): Activate the checkbox to deactivate the visibility of the wireless (WLAN) network.

The wireless (WLAN) connection is established. To complete the connection, it may be necessary to enter other data into the wireless device.

Repeat this process to connect other wireless devices.

Configuring internet access

The Infotainment System can use the WLAN hotspot of an external wireless device to establish an internet connection.

Establishing the connection with the wireless network (WLAN)

- Activate the wireless hotspot on the external device. If necessary, refer to the manufacturer's instruction manual.
- Press the Infotainment *MENU* button and then press the *SETTINGS* menu; **OR** access **Media** or **SEAT Media Control** mode and press the *SETTINGS* menu.
- Press the *WLAN* menu and then enter *INTERNET ACCESS SETTINGS* and activate the checkbox.
- Press the *Find* function button and select the wireless device you want from the list.
- If necessary, enter the network key of the wireless device in the Infotainment System and confirm with *OK*.

Manual settings: To manually enter the network settings of an external wireless (WLAN) device.

The wireless (WLAN) connection is established. To complete the connection, it may be necessary to enter other data into the wireless device.



 Note

Due to the large number of different wireless devices in existence, it is not possible to guarantee fault-free operation of all functions.

Audio and Media Mode

Radio Mode

Related video



Fig. 20 Radio mode

RADIO main menu



Fig. 21 RADIO main menu.



Fig. 22 Radio mode: station list (FM).

Press the infotainment **MENU** button **»» Fig. 1** **1** and then select the **Radio** context to open the RADIO main menu **»» Fig. 21**.

RADIO main menu function buttons

Function button: function	
1	To change the group of memory buttons slide a finger over the memory buttons from left to right or vice-versa
BAND	Allows you to select the frequency band.
STATION LIST	Opens the list of currently receivable radio stations »» page 33 .
MANUAL	Allows you to select the frequency manually »» page 33 .
VIEW	Allows you to select the information shown on the screen »» page 32 . The function button is only available in DAB mode.

Function button: function

SETTINGS Opens the setup menu of the active frequency band (FM, AM or DAB) **»» page 35**.

⏮ / ⏭ Selects the previous or next stored station (or available station). Adjustment of the arrow buttons in the Settings menu (FM, AM, DAB).

1 to 18 Memory buttons **»» page 32**.

SCAN Stops the scan function (only visible when the function is under way).

Information and possible icons

Display: Meaning

A View the frequency or the name of the station and, where applicable, the radio text. The name of the radio station and the radio text will only be displayed if equipped with RDS and if it is active **»» page 30**.

RDS Off The RDS radio data service is deactivated.

TP Traffic news is available **»» page 34**.

📴 No stations with traffic news are available.

★ The radio station is stored on a memory button.

AF off The tracking of alternative frequencies is disabled. **»»**

Note

- The availability of AM and DAB bands depends on the country and/or equipment. In the event that the AM and DAB bands are not available, the BAND function button text will not be shown.
- Bear in mind that being underground, in tunnels, in areas with tall buildings or mountains can interfere with radio signals.
- Foil or metal-coated stickers attached to the windows may affect reception on vehicles with a window aerial.
- Radio stations are responsible for the content of the information they transmit.

RDS radio data services (FM band)



Fig. 23 Standard representation: FM station list menu

The RDS (Radio Data System) offers additional information in FM such as the visualisation

of the station name, automatic station tracking (AF), text emitted by radio (Radio Text), traffic reports (TP) and station types (PTY).

Depending on the country and the unit in question, the RDS can be deactivated in the **FM setup** menu »» page 35.

Without RDS it is not possible to use **radio data services**.

Name of the station and automatic station tracking

If equipped with the RDS function, the names of the stations can be displayed in the main **RADIO** menu and in the **FM station list**.

FM radio stations may occasionally or continuously broadcast different content on different regional frequencies under the same station name (e.g. Station 3).

By default, automatic station tracking always switches to the currently selected station's frequency that offers the best reception, as the vehicle travels from one area to the next. As a result, this may cause the regional signal to be lost.

Automatic frequency changing and automatic station tracking can be deactivated in **FM setup** »» page 35.

Setting a station name

In some cases the name of the station is too long. This text may be blocked/unblocked by

pressing on the station name for 3 seconds until hearing an audible signal (a dot will appear/disappear on the left and right of the station name).

Radio text

Some RDS-enabled stations also broadcast additional text information known as radio text.

Radio Text is displayed in the upper half of the screen above the memory buttons »» Fig. 21 A.

The Radio Text display can be deactivated in **FM setup** »» page 35.

Station list order

Stations that are available at a certain time are displayed on the station list screen (**STATION LIST** function button). This list may be ordered by station group, by genre or alphabetically »» Fig. 23.

Note

- Due to matters of infrastructure, RDS functions may be limited in certain countries, and you may not be able to receive traffic announcements, automatic station tracking (AF) or programme types (PTY).

Digital radio mode (DAB, DAB+ and audio DMB)*

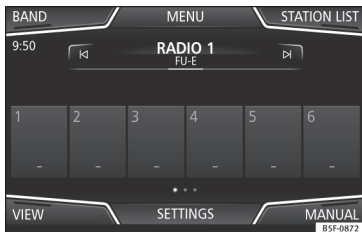

Fig. 24 Display of memory buttons in DAB mode.



Fig. 25 Display of station information in DAB mode.

The DAB radio receiver supports the DAB, DAB+ and DMB-Audio broadcasting standards.

In Europe, digital radio is transmitted via band III frequencies (from 174 MHz to 240 MHz).

The frequencies are referred to as “channels” and each one has a channel name (e.g. **12 A**).

Several available DAB stations are combined into one channel in an “ensemble”.

Starting Digital radio mode

- From the *RADIO* main menu press the **BAND** function button and select **DAB**.

The DAB radio station that was last selected will be played if it can still be received at the current location.

The selected DAB station is displayed in the upper bar of the screen; the group of selected stations is displayed below **»» Fig. 24**.

Additional DAB stations (Secondary Service Components)

Some DAB stations temporarily or permanently offer **additional stations**, (for example, for broadcasting sports events).

DAB stations containing additional stations are identified in the station list by means of the symbol **▶**.

Selecting additional stations

From the main screen	Press the name of the main station
	Press the memory button of the main station
From the station list	Select the additional station from the list

The DAB main menu shows the name of the additional selected station on the right alongside the abbreviated name of the main DAB station.

The additional stations cannot be stored.

Automatic station tracking

DAB is currently not available in all areas. In areas without DAB, **✖** is displayed in DAB radio mode.

If reception of the currently selected DAB station is lost (e.g. no DAB reception available), the Infotainment system attempts to find the station and tune to it on the other available frequency bands. If the station still cannot be found, the radio will be muted. Automatic station tracking can be activated in the DAB settings in the following modes **»» page 36**:

- DAB - DAB station tracking:** The radio attempts to tune into the same station on an alternative DAB frequency. Automatic station tracking only works if both DAB stations transmit the same station identifier or the **»»**

DAB signal indicates the corresponding other DAB station.

- **Automatic DAB - FM switching:** The radio attempts to tune into the same station on the FM frequency band. Automatic station tracking only works if the DAB station and the FM station transmit the same station identifier or the DAB signal indicates the corresponding FM station. Once the corresponding FM station has been found, “FM” is displayed after the station name. When reception for the corresponding DAB station returns, after a short time the unit will switch back to DAB mode and “FM” will no longer be displayed.

- **Switch to a similar station:** This allows service providers to indicate alternative stations with similar content. This way, if the radio loses reception of a DAB station and cannot find an alternative frequency for it on FM or DAB, there is a possibility of tuning in to a station with similar content.

Radio text

Some stations also broadcast additional text information known as radio text.

Radio text is displayed in the upper half of the screen above the memory buttons » **Fig. 24** or on the Station information or Radio text screens of the **Screen view** menu » **page 32**.

The radio text display can be deactivated in DAB settings » **page 36**.

Slideshow

Some stations broadcast images for additional visual information.

These images are displayed as a slideshow on the **Station information** or **Slideshow** screens of the **Screen view** menu » **page 32**.

The slideshow can be viewed in full screen by pressing on the current image.

Screen view menu

The function buttons refer to the menu that appears when the **View** button is pressed » **Fig. 24**.

Function button: function

Preset list: Memory buttons display » **Fig. 24**.

Station information: Simultaneous display of radio text and slideshows instead of the memory buttons » **Fig. 25**.

Radio text: Radio text is displayed instead of memory buttons.

Slideshow: The slideshows are displayed in full screen.

Note

- **Not all DAB stations broadcast radio text and slideshows.**

Memory buttons



Fig. 26 RADIO main menu.

In the **RADIO** main menu, you can store stations from all available frequency wavelengths on the numbered function buttons. These function buttons are called “memory buttons”.

Functions of the memory buttons

Selecting the station from the memory buttons

Press the memory button corresponding to the desired station.

The stored stations can only be played by pressing the corresponding memory button provided it can be received at your current location.

Functions of the memory buttons

Switching between memory banks	<p>Move your finger over the screen from left to right or vice-versa.</p> <p>OR: Press one of the function buttons » Fig. 26 A</p> <p>The memory buttons are displayed in three memory banks.</p>
Storing the station on the memory buttons	See: Storing stations » page 34.
Storing the station logo on the memory buttons	A station logo can be assigned to the stations stored on the memory buttons » page 33.

Storing station logos

Store automatically (only in FM and DAB mode)

When a station is stored the station logo is automatically assigned.

If there are 2 or more logos in the database, it gives the option to choose the correct one.

Store manually

The station logos can be imported from a compatible data medium (for example, memory card or memories with USB port).

- Press the function button **(SETTINGS)** and then **(Station logos)**.
- Press the station button where you wish to store the logo of a station.
- Select the source where the logo is stored (for example, **(SD card 1)**). We recommend saving logos in the memory unit's root directory.
- Select the station logo.
- Repeat the process to assign other logos; press the infotainment **(MENU)** button **» Fig. 1 ①** and then select the **Radio** context to return to the Radio main menu.
- If you wish to change the logo of a memory button that already has one assigned to it, it must first be deleted from the button in question.

Note

Not all stations are stored in the database and therefore it is not always possible to assign logos automatically.

Select, tune and store stations

Selecting stations

Select stations with the arrow buttons	Press either the (←) function button or (→) » Fig. 21 . This will change between available stations » page 35.
--	--

Selecting stations

Selecting stations from the station list	Press the (STATION LIST) » Fig. 21 function button to open the station list.
	Search through the list and press the required station to select it.
	To close the station list, press the (BACK) function button » Fig. 22 . The station list closes automatically after a period of inactivity.

Manually tuning in a station frequency.

Viewing the frequency dial	Press the (MANUAL) function button » Fig. 21 .
Changing the frequency in steps	Turn the adjustment knob. OR: Press the (+) or (-) keys on the dial that appears on the screen.
Browsing the frequency band quickly	Press and hold one of the arrow buttons on the left of the multifunction steering wheel. After releasing the arrow button, the unit automatically tunes to the next available radio station. OR: Place your finger on the slider in the frequency range and drag it to move the button.
Hiding the frequency band	Manual frequency selection is also closed if you select a station with a memory button. If no operation is performed, the frequency range will disappear after a period of inactivity. »

Storing stations

Storing the station that is currently being listened to.	<p>Press and hold the desired memory button »» Fig. 21 until an audible signal is heard.</p> <p>The station tuned in will be stored on this memory button.</p>
Storing a station on the list of stations	<p>Press the (STATION LIST) »» Fig. 21 function button to open the station list.</p> <p>The stations that are already stored on a memory button are marked on the station list with the symbol ☆ »» Fig. 22.</p> <p>Select the desired station by <i>pressing and holding it</i> on the screen. A screen will appear to store the station on the memory buttons.</p> <p>Press the memory button where the station is to be stored.</p> <p>An audible signal is heard and the station is stored on the memory button. To continue storing other stations from the list, repeat the process.</p>
	<p>All the stored stations can be deleted together or separately from the FM, AM, DAB Setup menu »» page 35.</p>

SCAN function

When the scan function is active, all available stations on the current frequency band are played in sequence for approximately 5 seconds each.

Starting and stopping the scan function

Starting the scan function	Press the (SETTINGS) function button and then select (SCAN).
Stopping the scan function	Press the (SCAN) function button to stop the scan function at the station that is currently playing.
	Manually selecting a station with the memory buttons or changing the screen also stops the scan function.

Traffic news (TP)

Traffic information tracking with the TP function is only possible if the station is available. The stations with the traffic information function are indicated in the RADIO main menu and in the list of stations by the **TP** symbol »» Fig. 21 and »» Fig. 22.

Some stations that do not broadcast their own traffic information support the TP function by broadcasting traffic warnings from other stations (EON).

Switching the TP function on and off

- Using the **Setup (FM, AM, DAB)** menu, activate or deactivate the **Traffic programme (TP)** by pressing it »» page 35.

Active TP function and station selection

Traffic warnings are played in **Audio mode**.

If a station is selected without the **TP** function in **FM mode**, the radio tries to find stations with this function in the background. If no station is found, this will be indicated half way up the left of the screen .

In **AM mode** or **media mode**, the unit will always automatically tune to a traffic news station in the background, provided that one is available. This procedure may take some time, depending on the situation.

Incoming traffic announcement

In active Audio mode, an incoming traffic announcement will play automatically.

During the traffic announcement, a pop-up window is displayed and the radio changes, depending on the case, to the traffic news station (EON).

The media mode is paused and the volume is adjusted to the preset level »» page 91.

The volume of the traffic announcement can be modified with the volume control . The

adjusted volume setting will be applied to subsequent announcements.

- Press the **Cancel** function button to end the current traffic announcement. The TP function remains switched on.
- **OR:** Press the **Deactivate** function button to end the current traffic warning and permanently deactivate the **TP** function. This can be reactivated in the **Settings** menu.

Setup (FM, AM, DAB)

FM setup

Select the **FM** frequency band by pressing the Infotainment **MENU** button **»» Fig. 1 1** and then select the **Radio** context.

OR: Press the **BAND** function button and select the **FM** frequency band.

Press the **SETTINGS** function button to open the **FM Settings** menu.

Function button: function

Sound: Sound settings **»»** page 91.

Scan: Scan function. When the scan function is active, all available stations on the current frequency band are played in sequence for approximately 5 seconds each **»»** page 34.

Seek mode: To adjust settings for the buttons with the arrows **K** and **D**. This setting applies to all frequency bands (FM, AM and DAB).

Function button: function

Preset list: All stored stations on the selected frequency band can be browsed with the arrow buttons.

Station list: All available stations on the selected frequency band can be browsed with the arrow buttons.

Scan: Scan function. When the scan function is active, all available stations on the current frequency band are played in sequence for approximately 5 seconds each **»»** page 34.

Traffic programme (TP): The TP function (traffic news station tracking) is active **»»** page 34.

Delete presets: To delete all or some of the stored stations.

Station logos: To manually assign or delete the stored station logos to and from the memory buttons **»»** page 33.

Radio text: Radio Text is active **»»** page 30, Radio text.

Advanced settings^{*)}: Setup of the RDS (radio data system).

Autostore station logos^{*)}: Logos can be automatically assigned to the stations stored on the memory buttons if they are available in the Infotainment system. Also see **»»** page 33.

Region for station logo^{*)}: Allows you to select the region (country) in which the vehicle is located. This optimises the automatic assignment of station logos. The option also allows the system to select the region automatically.

Function button: function

Alternative frequency (AF)^{*)}: The automatic station tracking is active. With the checkbox deactivated, the **RDS regional** function button remains inactive (grey).

Radio Data System (RDS)^{*)}: The Radio Data System (RDS) is deactivated **»»** page 30. If the checkbox is deactivated, the traffic news station functions (TP), Radio Text, station name and programme type will not be available.

RDS Regional^{*)}: Setting **automatic station tracking** by RDS **»»** page 30.

Fixed: The unit only switches to alternative frequencies for the selected station if the same regional service is being broadcast.

Automatic: the unit always switches to the station's frequency that currently offers the best reception. As a result, regional programmes may be interrupted.

^{*)} This depends on the country and unit in question.

AM Setup

Select the **AM** frequency band by pressing the Infotainment **MENU** button **»» Fig. 1 1** and then selecting the **Radio** context.

OR: Press the **BAND** function button and select the **AM** frequency band.

Press the **SETTINGS** function button to open the **AM Settings** menu. **»»**

Function button: function

Sound: Sound settings » page 91.

Scan: Scan function. When the scan function is active, all available stations on the current frequency band are played in sequence for approximately 5 seconds each » page 34.

Seek mode: To adjust settings for the buttons with the arrows **K** and **D**. This setting applies to all frequency bands (FM, AM and DAB).

Preset list: All stored stations on the selected frequency band can be browsed with the arrow buttons.

Station list: All available stations on the selected frequency band can be browsed with the arrow buttons.

Traffic programme (TP): The TP function (traffic news station tracking) is active » page 34.

Delete presets: To delete all or some of the stored stations.

Station logos: To assign the logos to the stations stored on the memory buttons » page 33.

DAB Settings

Select the **DAB** frequency band by pressing the Infotainment **(MENU)** button » **Fig. 1** **①** and then selecting the **Radio** context.

OR: Press the **(BAND)** function button and select the **DAB** frequency band.

Press the **(SETTINGS)** function button to open the **DAB Settings** menu.

Function button: function

Sound: Sound settings » page 91.

Scan: Scan function. When the scan function is active, all available stations on the current frequency band are played in sequence for approximately 5 seconds each » page 34.

Seek mode: To adjust settings for the buttons with the arrows **K** and **D**. This setting applies to all frequency bands (FM, AM and DAB).

Preset list: All stored stations on the selected frequency band can be browsed with the arrow buttons.

Station list: All available stations on the selected frequency band can be browsed with the arrow buttons.

Traffic programme (TP): The TP function (traffic news station tracking) is active » page 34.

Delete presets: To delete all or some of the stored stations.

Station logos: To assign the logos to the stations stored on the memory buttons » page 33.

Radio text: Radio Text is active » page 30, **Radio text**.

Advanced settings: DAB services setup.

Autostore station logos^{a)}: The station logos are automatically assigned when the radio stations are stored to the memory buttons » page 33.

DAB traffic announcements: DAB traffic announcements are played in the same way as TP traffic announcements in all operating modes.

Function button: function

Other DAB announcements: DAB announcements (news, sport, weather, warnings etc.) will interrupt the current DAB radio mode.

DAB-DAB station tracking: automatic station tracking within the DAB frequency range is activated.

Automatic DAB - FM switching: switching to FM frequency band is allowed for automatic station tracking.

Switch to a similar station: this allows service providers to indicate alternative stations with similar content.^{b)}

^{a)} This depends on the country and unit in question.

^{b)} Only available for the model: "Navi System Plus"

Media mode

Related video



Fig. 27 Media mode

Introduction

“**Media sources**” are audio sources containing audio files on various different data stor-

age devices (e.g. CD, memory card, external MP3 player). These audio files can be played by the Infotainment system via their corresponding drives or audio input sockets (internal CD drive, memory card slot, AUX-IN multimedia socket etc.).

Copyright

Audio and video files on data storage devices are usually protected by intellectual property rights, as per the corresponding national and international laws. Be aware of the current legal provisions!

Note

- **MPEG-4 HE-AAC audio coding technology and patents are licensed from Fraunhofer IIS.**
- **This product is subject to certain intellectual property rights and copyrights owned by the Microsoft Corporation. The use or distribution of this type of technology outside this product requires a licence from Microsoft or an authorised Microsoft company.**

- **The infotainment system only plays undamaged compatible audio files; other files are ignored.**
- **Consult the list of supported devices on the SEAT website.**

Requirements for data storage devices and files

Factory-fitted CD and DVD drives conform to safety class 1 according to DIN IEC 76 (CO) 6/ VDE 0837.

The Infotainment system only accepts standard 12 cm CDs/DVDs and memory cards with

these dimensions: 32 mm x 24 mm x 2.1 mm or 1.4 mm.

The supported file formats listed are collectively referred to below as “audio files”. A CD

containing audio files of these types is referred to as an “audio data CD”. »





Valid for the model: Navi System Plus

Data storage device	Requirements for playing in the unit	
	Audio files	Video files
<p>📀 Optical discs:</p> <ul style="list-style-type: none"> – audio CD (up to 80 min). – Standard video DVD and DVD-compatible audio DVD. – CD-ROM, CD-R, CD-RW with audio data up to a maximum of 700 MB (megabytes) using ISO 9660 Level 1 and 2, Joliet or UDF 1.02, 1.5, 2.01 file system. – DVD+/-R/RW up to a maximum of 4.7 GB and DVD double layer up to a maximum of 8.5 GB using Joliet (single-session only) file system; UDF. <p>💾 Memory cards:</p> <ul style="list-style-type: none"> – SD and MMC in the file system must be FAT12, FAT16, FAT32 or VFAT (max. 2 GB). – SDHC (max. 32 GB) and SDXC (max. 2 TB (terabytes) in exFAT and NTFS file systems. <p>🔌 USB data storage device:</p> <ul style="list-style-type: none"> – Devices compliant with USB 2.0 and 3.0 specifications – FAT16, FAT32, exFAT and NTFS file systems. – iPods^{TMa)}, iPads^{TMa)} and iPhones^{TMa)} of various generations. – MTP players with the “PlaysForSure” or “ReadyForVista” logo. <p>🎵 Jukebox (internal SSD memory).</p>	<ul style="list-style-type: none"> – Digital Audio specification. – MP2 (.mp2) and MP3 (.mp3) files with bit rates of between 32 and 320 kbit/s or variable bit rate. – WAV (.wav) files. – WMA (.wma) files up to 10 mono/stereo without copy protection and bit rates of up to 384 kbit/s. – AAC (.m4a, .m4b and .aac) files without copy protection – OGG-Vorbis 1 (.ogg) files with bit rates of up to 256 kbit/s. – FLAC (.flac) files. – Files in Matroska container (.mka) format. 	<ul style="list-style-type: none"> – Maximum resolution 720 x 576 pixel and 25-30 fps (frames per second). – MPEG-1 and MPEG-2 (.mpg, .mpeg, .m2ts, .avi and .mkv) format with maximum resolution of 352x288 pixel. – ISO MPEG-4 (.mp4, .m4v, .avi, .mov, .3gp and .mkv) format. – MPEG-4 ASP DivX 4, 5 and 6 (.avi, .divx and .mkv) format. – MPEG-4 Xvid (.avi and .mkv) format. – MPEG-4 H.264 format: (.mp4, .m4v, .mov, .3gp, .avi, .m2ts, .mkv, .flv, .f4v and .webm). – Windows Media Video 9 (.wmv, .asf, .mp4, .m4v, .mov, .3gp and .avi) format. – MJPEG (.avi, .mov, .mp4 and .m4v) format. – Theora (.ogv) format.
AUX Playing audio files via the AUX-IN socket.	<ul style="list-style-type: none"> – Playlists in the formats M3U, PLS, ASX and WPL. – Playlists must not exceed 20 kB or more than 1000 entries. – Filenames and paths that do not exceed 256 characters. – For DVD, a maximum of 1000 files per storage device and directory. – For memory cards, a maximum of 4000 files and a maximum of 1000 files per directory. – For Jukebox (SSD) a maximum of 3000 files. 	
📶 Audio file playback via Bluetooth ^{®b)} .	<ul style="list-style-type: none"> – The external audio source must meet a series of playback conditions ➤ page 48. 	
📶 Audio file playback via WLAN.	<ul style="list-style-type: none"> – The external media player must be compatible with the A2DP Bluetooth[®] profile ➤ page 48. 	
	<ul style="list-style-type: none"> – The external audio source must meet a series of playback conditions ➤ page 51 	

a) iPodTM, iPadTM and iPhoneTM are registered trademarks of Apple Inc.

b) Bluetooth[®] is a registered trademark of Bluetooth[®] SIG, Inc.

Valid for the model: Media System Plus/Navi System

Data storage device	Requirements for playing in the unit
<p> Optical discs:</p> <ul style="list-style-type: none"> – audio CD (up to 80 min). – CD-ROM, CD-R, CD-RW with audio data up to a maximum of 700 MB (mega-bytes) using ISO 9660 Level 1 and 2, Joliet or UDF 1.02, 1.5, 2.01 file system. <p> Memory cards:</p> <ul style="list-style-type: none"> – SD and MMC in the file system must be FAT12, FAT16, FAT32 or VFAT (max. 2 GB). – SDHC (max. 32 GB) and SDXC (max. 2 TB (terabytes) in exFAT and NTFS file systems. <p> USB data storage device:</p> <ul style="list-style-type: none"> – Devices compliant with USB 2.0 and 3.0 specifications. – FAT16, FAT32, exFAT and NTFS file systems. – iPods™^{a)}, iPads™^{a)} and iPhones™^{a)} of various generations. – MTP players with the “PlaysForSure” or “ReadyForVista” logo. 	<p>Audio files</p> <ul style="list-style-type: none"> – Digital Audio specification. – MP2 (.mp2) and MP3 (.mp3) files with bit rates of between 32 and 320 kbit/s or variable bit rate. – WAV (.wav) files. – WMA (.wma) files up to 10 mono/stereo without copy protection and bit rates of up to 384 kbit/s. – AAC (.m4a, .m4b and .aac) files without copy protection – OGG-Vorbis 1 (.ogg) files with bit rates of up to 256 kbit/s. – FLAC (.flac) files. <ul style="list-style-type: none"> – Playlists in the formats M3U, PLS, ASX and WPL. – Playlists must not exceed 20 kB or have more than 1000 entries. – Filenames and paths that do not exceed 256 characters. – For memory cards, a maximum of 4000 files and a maximum of 1000 files per directory.
<p>AUX Playing audio files via the AUX-IN socket.</p>	<ul style="list-style-type: none"> – The external audio source must meet a series of playback conditions » page 48.
<p> Audio file playback via Bluetooth®^{b)}.</p>	<ul style="list-style-type: none"> – The external media player must be compatible with the A2DP Bluetooth® profile » page 48.

^{a)} iPod™, iPad™ and iPhone™ are registered trademarks of Apple Inc.

^{b)} Bluetooth® is a registered trademark of Bluetooth® SIG, Inc.

Read and bear in mind the manufacturer's instruction manual for the external data storage device.

Restrictions and instructions

Contamination, exposure to high temperatures and mechanical damage may render a data medium unusable. Please observe the manufacturer's instructions.

Variations in the quality of data media produced by different manufacturers can lead to problems during playback.

Please observe copyright laws.



The unit may be unable to read individual tracks or the entire data medium due to the data medium configuration or the devices and programs used for recording. Information about the best ways to create audio files and data media (compression rate, ID3 tag etc.) can be found on the Internet.

The reading time may vary considerably depending on the condition of the data medium (copying and deleting actions), folder structure and file type.

Playlists only determine a certain playing order. There are **no** files stored in a playlist. The unit will **not** play a playlist if the files are **not** stored on the data medium at the locations referred to by the playlist (relative file paths).

A cover can only be displayed when the name starts with “**Cover**”, “**Folder**” or “**Album**”.

Note

- Do not use memory card adapters.
- SEAT assumes no liability for any deterioration or loss of files on data storage devices.

Playing order of files and folders

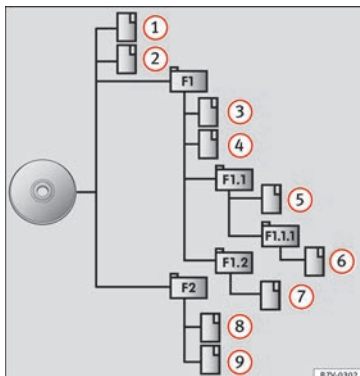

Fig. 28 Possible structure on an audio data CD

The audio files stored on data storage devices are often organised by means of folders and playlists to determine a certain playing order.

Tracks, folders and playlists on a data storage device are sorted by name in alphanumeric order.

The image shows a standard CD with audio data which contains tracks , folders and subfolders **»» Fig. 28.**

In this case, the tracks are played in this manner¹⁾:

1. Tracks and in the CD's root directory
2. Tracks and in the **first** folder **F1** in the CD's root directory
3. Track in the **first** subfolder **F1.1** of the folder **F1**
4. Track in the **first** subfolder **F1.1.1** of the subfolder **F1.1**
5. Track in the **second** subfolder **F1.2** of the folder **F1**
6. Tracks and in the **second** folder **F2**

Note

- The play order can be modified by selecting different playback modes **»»** page 41.
- Playlists are not played automatically, instead they have to be specifically selected via the track selection menu **»»** page 44.

¹⁾ In the **Media Settings** menu, the **Mix/Repeat including subfolders** function must be activated **»»** page 53.

MEDIA main menu

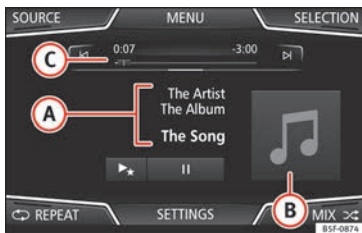

Fig. 29 MEDIA main menu.

Using the *MEDIA* main menu, different media sources can be selected and played.

- Press the infotainment **MENU** button »» Fig. 1 ① and then select the **Media** context to open the *MEDIA* main menu »» Fig. 29.

It will continue playing the last media source selected from the same point.

The media source being played is indicated on the dropdown list when pressing the **SOURCE** function button »» Fig. 29.

If there is no available media source, the *MEDIA* main menu is displayed.

MEDIA main menu function buttons

Function button: function	Function button: function
	Indicates the media source being played. Press to select another media source »» page 42. (JUKEBOX) ^{a)} : Internal hard drive (SSD) »» page 49. (CD/DVD) ^{b)} : Internal CD and DVD drive »» page 46. (SD CARD 1) , (SD CARD 2) : SD memory card »» page 46. (USB 1) , (USB 2) : External data storage device connected to the USB port »» page 47. (AUX) : External audio source connected to the AUX-IN multimedia socket »» page 48. (BT AUDIO) : Bluetooth® audio »» page 48. (WLAN) ^{a)} : External audio source connected by WLAN »» page 51
SOURCE	
SELECTION	Opens the track list »» page 44.
⏮ / ⏭	Changes track in Media mode or fast forward/rewind »» page 43.
⏸	Playback stops. The (⏸) function button changes to (▶) .
▶	Playback is resumed. The (▶) function button changes to (⏸) .

Function button: function

▶ ★ ^{a)}	Play more like this. Creates a virtual playlist that includes tracks with a similar rhythm to the one being played if available using Gracenote®.
SETTINGS	Opens the Media Settings menu »» page 53.
↺	Repeat all tracks. Repeats all the tracks that are on the same memory level as the track being played at that moment. If in the Media Settings menu (☑ Mix/Repeat including subfolders) is activated, it also includes the subfolders »» page 53.
REPEAT	The current track will be repeated.
REPEAT	Random play.
MIX ↻	Includes all the tracks that are on the same memory level as the track being played at that moment. If in the Media Settings menu (☑ Mix/Repeat including subfolders) is activated, it also includes the subfolders »» page 53.

^{a)} Only available for the model: "Navi System Plus".

^{b)} The DVD drive is only available for the model: "Navi System Plus".



Messages and symbols on the MEDIA main menu

Display: Meaning

Displays information about the artist name, album name and song title (CD text , ID3 tag on compressed audio files).

A Audio CD: displays track information if available via Gracenote^{®a)}. If no data is available, it only displays **Track** and the number corresponding to the position it occupies on the data storage device.

Viewing the album cover: If there are various covers within the same folder/album, the system only displays one of them. It prioritizes displaying the covers in the following manner:

- B**
1. Cover embedded in the file(s).
 2. Image in file folder.
 3. Image provided by the Gracenote^{®a)} database.
 4. Default icon for the connected device.

If playing a video file, by pressing the icon (cover) it can be played on full screen.

C The playing time so far and time remaining in minutes and seconds. In the case of audio files with variable bit rates (VBR) the remaining time may vary.

RDS Off^{b)} The RDS radio data service is deactivated. The RDS can be activated in the **FM setup menu** **»» page 35**.

TP^{b)} The TP function is active and can be tuned in **»» page 34**.

Display: Meaning

^{b)} There is no traffic news station available **»» page 34**.

^{b)} DAB not available **»» page 31**.

a) Gracenote[®] is a database available on the Infotainment system hard drive that contains information on the tracks of different artists and albums. In order for the user to benefit from the functions offered by Gracenote[®], the tracks must contain the artist and/or album data (only available for the model: "Navi System Plus").

b) Depends on the market and unit in question.

Note

- **When the media source is inserted, playing will not start automatically; it is necessary for the user to select the source. Nor will the media source change when it is ejected.**
- **In order to see the different covers inside of the same album/folder, make sure that the tracks contain different information about the Artist or Album in its metadata. If not, you will see the same cover for all of tracks contained in the same album/folder.**

Change the media source



Fig. 30 MEDIA mode: change media source.

- From the *MEDIA* main menu, press the **(SOURCE)** function button **»» Fig. 30** and select the desired media source.

In the pop-up window, the Media sources not selected are shown as deactivated (in grey).

When a Media source that has already been played is selected again, playback is resumed from the point at which it was stopped.

Optionally selectable media playback sources

Function button: Media source

(JUKEBOX)^{a)} Internal hard drive (SSD) **»» page 49**.

(CD/DVD)^{b)} Internal CD/DVD drive **»» page 46**.

Function button: Media source

SD CARD 1	SD memory card »» page 46.
SD CARD 2*	
USB 1	External data storage device connected to the USB port »» page 47.
USB 2*	
AUX	External audio source connected to the AUX-IN multimedia socket »» page 48.
BT AUDIO	Bluetooth® audio »» page 48.
WLAN ^{a)}	External audio source connected by WLAN »» page 51

a) Only available for the model: "Navi System Plus".

b) The DVD drive is only available for the model: "Navi System Plus".

 Note

The Media source can be changed in the Track list view »» page 44.

Changing track in the MEDIA main menu

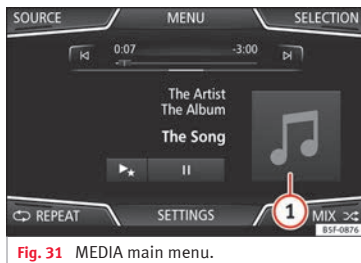









Fig. 31 MEDIA main menu.

It is possible to browse through the tracks of the Media source that is currently playing using the arrow buttons.

It is **not** possible to exit a playlist or start the playback of a playlist using the arrow buttons. Both actions must be performed manually from the track selection menu »» page 44.

Controlling playback via the MEDIA main menu

Action	Function
Briefly press the  function button once.	Goes to the start of the current track. If the track has been playing for less than 3 seconds, it skips to the beginning of the previous track.
Quickly press the  function button twice.	If the track has been playing for more than 3 seconds, it skips to the beginning of the previous track; from the first track it skips to the last track on the data storage device being played.
Briefly press the  function button once.	Goes to the next track. It changes from the previous track to the first track of the data storage device being played.
Press and hold the  function button.	Fast rewind.
Press and hold the  function button.	Fast forward.
Slide your finger horizontally across the screen.	Changes to the previous/next track, respecting the same playing times as when changing tracks with the  or  buttons.

Selecting an album by its cover

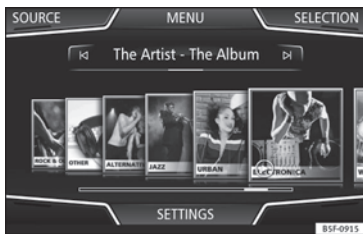

Fig. 32 Selecting by cover.

When pressing the current cover »» Fig. 31 ①, it displays all the album covers available in the active media source. »» Fig. 32.

It is possible to browse through all the albums by sliding the covers left or right or by using the bottom horizontal slide bar.

The selection by cover view will close after approximately 5 seconds of inactivity and will return to the main Media menu.

Selection of a track from a list of tracks

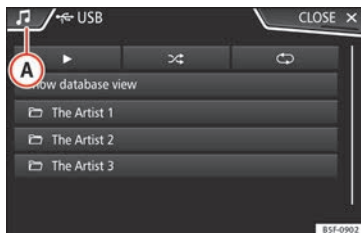

Fig. 33 Media mode: list of folders on a media source.

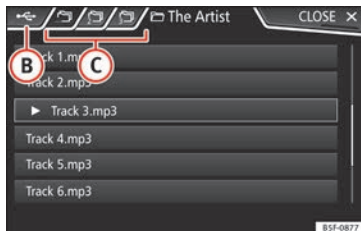

Fig. 34 Media mode: list of tracks on a Media source.

Opening a track list

- From the *MEDIA* main menu, press the **(SELECTION)** »» Fig. 31 function button to open

the track list. The track that is currently playing is highlighted »» Fig. 34.

- Search through the track list and press the desired track.

If there is information available on the track, the track is displayed (for audio CDs) or the name of the file (MP3), rather than **Track + number**.

Overview of the function buttons on the track list

Function button: function

Ⓐ

Open the **Sources** menu. Select another media source by pressing.

Function button: function

Indicates the media source being explored. If pressed it goes to the root folder of the device indicated on the icon.

(JUKEBOX)^{a)}: Internal hard drive of the Infotainment system (SSD) » page 49.

(CD/DVD)^{b)}: Internal CD and DVD drive » page 46.

(SD CARD 1), (SD CARD 2)^{*}: SD memory card » page 46.

(USB 1), (USB 2)^{*}: External data storage device connected to the USB port » page 47.

(BT AUDIO): External media player connected by Bluetooth » page 48.

(AUX): Audio source connected to the AUX-IN socket » page 48

(WLAN)^{a)}: External audio source connected by WLAN » page 51

Press the function button to open the top folder of the media source.

Starts playback of the first track.

Function button: function

Repeat all tracks.



Repeats all the tracks that are on the same memory level as the track being played at that moment. If in the **Media Settings** menu **Mix/Repeat including subfolders** is activated, it also includes the subfolders » page 53.

Random play.



Includes all the tracks that are on the same memory level as the track being played at that moment. If in the **Media Settings** menu **Mix/Repeat including subfolders** is activated, it also includes the subfolders » page 53.

CLOSE x To close the track list.

^{a)} Only available for the model: "Navi System Plus".

^{b)} The DVD drive is only available for the model: "Navi System Plus".

Note

The tracks, folders and playlists can also be selected by turning the setup button, and can be played or opened by pressing it.

Database view

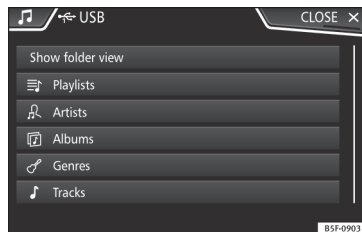

Fig. 35 Media mode: database view

From the track list, press the **Show database view** option. The content of the current Media source will be displayed classified by **Playlists**, **Artists**, **Albums**, **Genres**, **Tracks** and **Videos** » **Fig. 33**.

When selecting one of the **Artists**, **Albums** or **Tracks** folders, a search button appears in the top right (magnifying glass) which allows a search to be carried out in the selected category. » page 11, Input masks with on-screen keypad.

To return to the folder view, press the **Show folder view** option from the **SELECTION** Menu.

Insert or eject a CD or DVD¹⁾

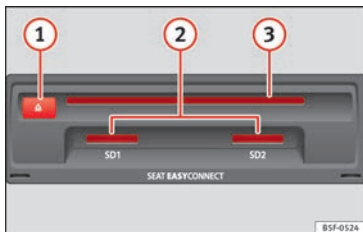

Fig. 36 Slots for data storage devices in the glove compartment.

The driver should refrain from operating the unit while the vehicle is in motion. Insert or change the data storage device before moving off!

The CD and DVD drive can play audio CDs and DVDs and audio data CDs and DVDs.

Insert a CD or DVD

- Hold the CD or DVD with the printed side facing up.
- Push the CD or DVD into the DVD slot » **Fig. 36** ③ to the point where it is drawn in automatically.

Eject a CD or DVD

- Press button **(A)** ①.
- The CD or DVD in the drive will be ejected and must be removed within approximately 10 seconds.

If the CD or DVD is not removed within the 10 seconds, it is automatically retracted for security reasons without activating the CD or DVD mode.

Unreadable or defective CD or DVD

If the data on an inserted CD or DVD cannot be read or a faulty CD or DVD is inserted, the corresponding warning appears on screen.

Depending on the unit, unreadable CDs or DVDs are ejected 3 times automatically and inserted again to initiate another three attempts before said message is displayed.

i Note

- **Uneven road surfaces and strong vibrations can cause playback to jump.**
- **When the temperature inside the unit is too high, loading and playback of CDs and DVDs is disabled.**
- **If after inserting a number of different CDs or DVDs and receiving the CD drive error every time, contact a qualified workshop.**

Insert or eject a memory card

Depending on the features and the country, the vehicle may have one or two slots for SD cards.

Inserting a memory card

Insert the compatible memory card, bevelled edge first and with the label face up (contacts face down), into slot » **Fig. 36** ②, until properly inserted.

If a memory card cannot be inserted, make sure it is positioned correctly and is compatible with the unit.

Removing a memory card

The inserted memory cards **must** be prepared for removal.

- From the main Media menu, press the **(SETTINGS)** button to open the **Media Settings** menu or press the Infotainment **(MENU)** button » **Fig. 1** ① and then press the **Settings** context to open the **System settings** menu.
- Press the **(Remove safely)** function button. A dropdown menu appears with the following options: SD1 Card, SD2 Card*, USB1 and USB2*. After correctly ejecting the memory

¹⁾ The DVD drive is only available for the model: "Navi System Plus".

card from the system, the function button becomes inactive (grey colour).

- Press the inserted memory card. The memory card “jumps” to the eject position.
- Remove the memory card.

Unreadable memory card

If a memory card is inserted and the data cannot be read, the relevant warning appears.

External data storage device connected to USB port

Depending on the features and the country, the vehicle may have one or two USB connections. For their location consult the **» Booklet Instruction Manual**.

Audio files on an external data storage device connected to the USB port  can be played and controlled via the Infotainment system.

Where this manual refers to external data storage devices, this means USB mass storage devices containing supported audio files, such as MP3 players, iPods™ and USB sticks.

Only supported audio files are displayed and played. Other files are ignored.

Further operation of the external data medium (changing track, selecting tracks and playback modes) is described in the appropriate chapters of this manual **» page 37**.

Instructions and restrictions

Compatibility with Apple™ devices and other media players depends on the unit.





The USB port  supplies the usual USB voltage of 5 volts for a USB connection.

External hard disks with a capacity greater than 32 GB must be reformatted for the FAT32 file system in some circumstances. You will find the necessary software and information on the Internet.

Take into account all other instructions and limitations regarding requirements for media sources **» page 37**.

iPod™, iPad™ and iPhone™

Depending on the country and the equipment, iPods™, iPads™ or iPhones™ can be connected using the device's USB cable to the USB port  of the vehicle and used as audio sources.

After connecting an iPod™, iPad™ or iPhone™, the specific list views of the iPod are displayed in the upper selection level ( **Playlists**,  **Artists**,  **Albums**,  **Tracks**,  **Podcasts** etc.).

Possible error messages after connecting an external data storage device

Error message	Cause	Procedure
The device is not compatible	The external data carrier cannot be played or communication is not possible with the adapter cable being used.	Check the connection and make sure the external data storage device is working correctly. If possible, update the external data storage device software.
The device does not work	Communication fault.	Check the connection and make sure the external data medium is working correctly.

Due to the large number of different data storage devices and various iPod™, iPad™ and iPhone™ generations available, it is not possible to guarantee fault-free operation of all functions described here.

Disconnecting

Any connected data storage devices **must** be prepared before their disconnection in order to remove them.

- From the main Media menu, press the **SETTINGS** button to open the **Media Settings** menu or press the Infotainment **MENU** button **» Fig. 1**  and then press the **Settings** context to open the **System settings** menu. **»**

- Press the **Remove safely** function button. A dropdown menu appears with the following options: SD1 Card, SD2 Card*, USB1 and USB2*. After correctly ejecting the data storage device from the system, the function button becomes inactive (grey colour).
- Now the data storage device can be disconnected.

Note

- Do not connect an external media player at the same time to play music via Bluetooth® and via the USB port  with the Infotainment system, as this could cause playback limitations.
- If the external player is an Apple device™, it cannot be simultaneously connected by USB and by Bluetooth.
- If a connected device is not recognised, disconnect all the connected devices and try connecting the device again.
- Do not use memory card adaptors, USB extension cords or USB hubs!

External audio source connected to the AUX-IN multimedia socket

Depending on the equipment and country there may be an AUX-IN multimedia socket **» Booklet Instruction Manual.**

In order to connect the external audio source to the AUX-IN socket, a suitable cable is re-

quired with a 3.5 mm jack that is inserted into the AUX-IN socket of the vehicle.

The connected external audio source is played over the vehicle speakers and **cannot** be controlled via the Infotainment system controls.

The connection of an external audio source is indicated by **AUX** on the screen.

Connecting an external audio source to the AUX-IN multimedia socket

- Lower the base volume on the Infotainment system.
- Connect the external audio source to the AUX-IN multimedia socket.
- Start playback on the external audio source.
- In the MEDIA main menu, press the **SOURCE** function button and select **AUX**.

The **output volume** of the connected external audio source should be adjusted to the volume of the other audio sources **» page 91.**

Information on operating an external audio source connected to the AUX-IN multimedia socket

Operation	Effect
Selection of another audio source from the Infotainment system.	The external audio source continues to run in the background.

Operation	Effect
Stopping playback on the external audio source.	The infotainment system remains in the AUX menu.
Disconnecting the plug from the AUX-IN multimedia socket.	The infotainment system remains in the AUX menu.

Note

- Please read and observe the manufacturer's instruction manual for the external audio source.
- Interference noise may be heard if the external audio source is powered from the 12-volt power socket of the vehicle.

Connecting an external audio source via Bluetooth®

Bluetooth® Audio mode allows you to listen to audio files being played on a Bluetooth® audio source (e.g., a mobile telephone) connected via Bluetooth® (audio playback by Bluetooth®) over the vehicle speakers.

Conditions

- The Bluetooth® audio source must support the A2DP Bluetooth® profile.
- In the **Bluetooth settings** menu, the **Bluetooth Audio (A2DP/AVRCP)** function must be activated **» page 87.**

Starting Bluetooth® audio transfer

- Activate Bluetooth® visibility on the external Bluetooth® audio source (e.g., mobile telephone).
- Lower the base volume on the Infotainment system.
- In the MEDIA main menu, press the **SOURCE** function button and select **BT audio**.
- Press **Search for new device** in order to connect an external Bluetooth® audio source for the first time » page 78.
- **OR:** Select a Bluetooth® external audio source from the list.
- Please refer to the instructions on the screen of the Infotainment system and on the Bluetooth® audio source regarding the rest of the procedure.

You may still need to manually start playback on the Bluetooth® source.

When playback on the Bluetooth® audio source is stopped, the Infotainment system remains in Bluetooth® Audio mode.

Controlling playback

The extent to which the Bluetooth® audio source can be controlled via the Infotainment system depends on the connected Bluetooth® audio source.

The available functions will depend on the Bluetooth® Audio profile that the connected external player supports.

With media players that support the AVRCP Bluetooth® profile, playback on the Bluetooth® audio source can be automatically started or stopped when the unit is switched to Bluetooth® Audio mode or to a different audio source. In addition, it is possible to view or change the track via the Infotainment system.

i Note

- **Due to the large number of possible Bluetooth® audio sources, it is not possible to guarantee fault-free operation of all described functions.**
- **Always switch off the warning and service tones on a connected Bluetooth® audio source, e.g. key tones on a mobile telephone, to prevent possible interference noise and malfunctions.**
- **To play music, do not link the external media player simultaneously to Bluetooth and the USB interface of the infotainment system, as this can cause limitations during playback.**
- **Depending on the external player connected, the response time of the system can vary.**

- **Do not connect an external media player to play music via Bluetooth® and via the USB port** » page 47 **at the same time with the Infotainment system, as this could cause playback limitations.**
- **If the external player is an Apple device™, it cannot be simultaneously connected by USB and by Bluetooth.**

Jukebox (SSD)

✓ Only available for the model: Navi System Plus

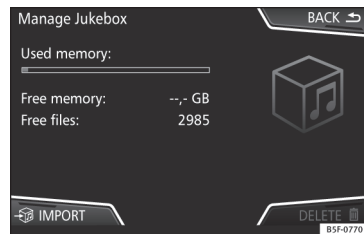

Fig. 37 Manage Jukebox

The “jukebox” is located on the hard drive of the Infotainment system (SSD¹⁾).

Compressed audio files (MP3 and WMA) and some video files (Podcasts, AVIs, etc.) can be »

¹⁾ Solid-State-Drive (SSD).

imported from different data storage devices to the **jukebox** and this used to play them.

The files will only be copied when the engine is running. Copying copy-protected CDs and DVDs is prohibited

Importing files

- In Media mode, press the **SETTINGS** function button and then select **Manage jukebox**.
- Press the **IMPORT** function button.
- Select the desired source from the **Select source** menu.

The data storage device is prepared. This operation may take a few seconds.

- Activate the checkboxes to the right of the files or folders to be imported.
- If **Select all** is activated, all files and folders on the data storage device will be imported.
- Press the **IMPORT** function button.

Depending on the selection, all files and folders will be imported with the indicated name to the **Jukebox**.

If no track information is available, the audio files will be placed in the following folders:

Audio data CD

■ Album

- **Unknown albums**
 - **Track**. mp3¹⁾
- **Artists**
 - **Unknown artists**
 - **Unknown albums**
 - **Track**. mp3¹⁾

Functions and progress display during the copying operation

While copying, an animation is displayed along with the progress percentage on the import screen.

Audio data CD: It is not possible to copy and play files at the same time.

- Press the **Cancel** function button to end the import of the whole track that is currently being imported.
- To obtain information on the status of the import, press the **Information** function button.
- Press the **BACK** function button to close the import screen with the progress information.
- When the file import ends, a message will appear.

Deleting files

- In Media mode, press the **SETTINGS** function button and then select **Manage jukebox**.

- Press the **DELETE** function button.
- Activate the checkboxes to the right of the files or folders to be deleted.
- If **Select all** is activated, all the files and folders on the data storage device will be deleted.
- Press the **DELETE** function button. The files and folders will be deleted according to the selection made.
- When the files have been deleted, a message will appear.
- Press the **BACK** function button to close the menu.

Opening stored audio and video files

- Change to **Jukebox** (SSD) content
» page 44.

When storing the tracks, they are stored under different categories and lists according to the information available.

The tracks saved can be checked and opened from these lists according to different categories.

Jukebox

- Playlist
- Artist
- Album

¹⁾ The name and extension of the file are examples.

- Music genre
- Title
- Video
- Non-playable files (an unsupported file has been imported).

Note

- If the Infotainment system cancels a copying operation, check the storage space on the internal hard drive and check the data storage device.
- Due to copyright laws, before any change in ownership of the Infotainment system, all files stored on the jukebox must be deleted.
- There are various possible reasons why files may be shown with inactive status (grey colour): files that cannot be imported (e.g. images), files that are already present in Jukebox or files that occupy more space than is available in the internal memory.

Connecting an external audio source via WLAN

✓ Only available for the model: Navi System Plus

WLAN allows wireless connection between an external audio source (for example a smart phone) and the Infotainment system.

To use this connection, the device being connected must have an app compatible with the UPnP (Universal Plug and Play) communi-

cation protocol, allowing the app to provide the system with the available media content.

Conditions

- Having a compatible (UPnP) app installed on the mobile device.
- Having the **mobile hotspot** found in the wireless connection configuration active »» page 51, **WLAN setup**.
- Pairing the mobile device to the Infotainment system using a password generated by the system. The pairing must be done from the mobile device that you wish to connect to the Infotainment system.

Starting the WLAN audio transfer

- Lower the base volume on the Infotainment system.
- Start the UPnP app or the app for the playback of the WLAN audio source.
- In the MEDIA main menu, press the **SOURCE** function button and select **WLAN**.
- Please refer to the instructions on the screen of the Infotainment system and on the WLAN audio source regarding the rest of the procedure.

Controlling playback

The extent to which the WLAN audio source can be controlled via the Infotainment sys-

tem depends on the connected WLAN audio source and the application used.

Note

- **The Infotainment system does not provide an internet connection, it only establishes a wireless connection between the mobile device and said system.**
- **Via the WLAN, only the connection between the device and the Infotainment system can be guaranteed, its operation depends on the application itself.**

WLAN setup

✓ Only available for the model: Navi System Plus

To access the WLAN settings, the ignition must be on.

- Select the Media Main menu by pressing the Infotainment **MENU** button »» **Fig. 1 1** and then selecting the **Media** context.
- Press the **SETTINGS** function button to open the **Media Settings** menu.
- Press the **WLAN** function button, then the **Hotspot settings** button will appear, together with a text with information about using the WLAN.
- Press the **Hotspot settings** function button, and you will then be able to switch on/off the **Mobile hotspot** and access the **Configuration** of the WLAN network. »»

- Press the **Configuration** function button to configure the WLAN network.

Function button: function

Mobile hotspot: To switch the WLAN network on/off.

Security level: WPA2 encryption automatically generates an 8-character network key.

Network key: Network key automatically generated. Press the function button to manually change the network key. The network key must have a minimum of 8 characters and a maximum of 63.

SSID: Name of the Infotainment system WLAN network.

Do not send network name (SSID): Activate the checkbox to deactivate the visibility of the WLAN network.

To save the changes made to the mobile hotspot configuration, press the **STORE** button.

DVD video mode

✓ Only available for the model: Navi System Plus



Fig. 38 DVD main menu.

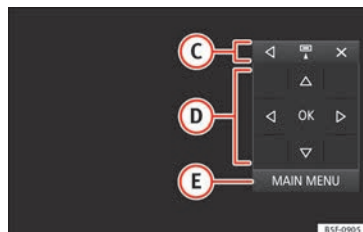

Fig. 39 DVD mode control menu.

DVD video regional code

Quite often, the playback of DVD video is limited to certain regions (for example, to the US and Canada) by so-called “region codes”. These DVDs can only be played on units that are coded for the same region.

The unit’s DVD drive is configured to read the regional code for the region in which the vehicle was originally sold.

Start DVD mode

- Insert a compatible DVD in the DVD drive.

The reading of DVD data may take a few seconds.

The DVD’s “intro” (short initial sequence) is played. Next, the different DVD menus are displayed.

Controlling the DVD menu

- Briefly touch the screen to activate the function buttons in the *DVD mode* main menu »» Fig. 38.

Function button: function

SOURCE Display and selection of the source.

DVD MENU To display the control menu and return to the main DVD screen »» Fig. 39.

A Chapter display.

B Displays play time duration and remaining play time.

Move the control menu window.

Minimise the control menu window.

C Maximise the control menu window.

Close the control menu.

Function button: function

- D** Use the arrow buttons to browse the DVD menu. Confirm the selection by pressing **OK**.
- E** Press to open the DVD main menu.
- ⏪ / ⏩** To move to the next or previous chapter.
- ⏸** Playback stops. The **⏸** function button changes to **▶**.
- ▶** Playback is resumed. The **▶** function button changes to **⏸**.
- SET-TINGS** This menu contains the Video (DVD) settings » page 53.

i Note

- **The visual appearance of the DVD film menus and the menu options which it offers are the responsibility of the DVD manufacturer.**
- **The difference in behaviour of some films when using the same mode is the responsibility of the DVD manufacturer.**
- **You may not be able to play video DVDs which you have burned yourself.**
- **The Infotainment system screen only displays the image when the vehicle is stopped. Whilst in motion, the screen disconnects (the image), but the audio remains active.**

Video settings (DVD)

✓ Only available for the model: Navi System Plus

In the *DVD mode* main menu, press the **SETTINGS** function button and then select the option Video settings (DVD).

Function button: function

- Format**: To select the screen format. If **Automatic** is selected, it adjusts automatically to the optimal format for the screen.
- Audio channel**: select language for acoustic voice output.
- Subtitles**: To select the subtitle language.
- Enter/change PIN for parental settings**: Parental settings password.
- Parental settings**: To select the level of protection for DVD playback.

The options in the Video setup (DVD) menu may vary depending on the DVD or the chapter currently being played.

The available audio language channels and subtitles depend on the inserted DVD.

All or a part of the DVD video content may be protected by means of a password (PIN) if the DVD is compatible with parental settings. Furthermore, the level of protection can be set according to age with 1 being the least restrictive (appropriate for all audiences) and 8, the most restrictive (adults).

Media settings

- Select the *MEDIA* main menu by pressing the Infotainment **MENU** button » **Fig. 1 1** and then selecting the **Media** context.
- Press the **SETTINGS** function button to open the **Media Settings** menu.

Function button: function

- Sound**: Sound settings » page 91.
- Manage jukebox^{a)}**: To import files to the jukebox or delete stored files » page 49.
- Mix/Repeat including subfolders**: Subfolders will be included in the selected playback mode » page 37.
- Bluetooth**: Bluetooth® settings » page 87
- WLAN^{a)}**: WLAN settings » page 51.
- Video settings**: Settings for playback of DVD videos or files.
- Remove safely**: In order to prepare the external data storage devices for their removal or disconnection. See also » page 46, Insert or eject a memory card and » page 47, External data storage device connected to USB port ←.
- Traffic programme (TP)**: The TP function (traffic news station tracking) is active » page 34.

^{a)} Only available for the model: "Navi System Plus".

Images



Fig. 40 Images main menu.

Using the *Images* menu, image files can be viewed (e.g. photos) individually or as a slideshow.

The image files must be stored on a compatible data storage device (e.g., a *CD* or an *SD card*).

- Press the Infotainment **(MENU)** button »» **Fig. 1** **(1)** and then select the **Images** context.
- Press the **(SOURCE)** function button to select the source where the pictures in question are located.

Function button: function

SOURCE Viewing and selecting the source.

SELECTION Opens a list of image files.

Function button: function

The image viewed was obtained via GPS localisation and upon pressing this function button, the navigator menu opens to start a route to this destination.

Rotate the view of the image to the left or the right.

Reset the view of the image.

To stop the playback of a slideshow. The function button changes to .

To continue the playback of a slideshow. The function button changes to .

To change to the **PREVIOUS** or **NEXT** image.

The same function can be performed by sliding your finger horizontally across the screen.

SETTINGS Open the Image settings menu.

Enlarging or reducing the view

To enlarge or reduce the view of the image displayed:

- Stretch or reduce the image on the screen using 2 fingers.

Rotating the view/image

To rotate an image, in addition to the buttons provided for this (/) , you can also press

on the screen (e.g. with your thumb) and, while continuing to press with your thumb, slide another finger (e.g. your index finger) around it like a compass either clockwise (to rotate the image to the right) or anti-clockwise (to turn the image to the left). This will rotate the image 90° with respect to its current position.

Requirements for viewing images

Image files	Maximum resolution
BMP	4MP
JPEG	4MP (Progressive Mode)
JPG	64MP
GIF	4MP
PNG	4MP

Image settings

Open the Image settings menu

- In the *Images* main menu, press the **(SETTINGS)** function button.

Function button: function

Image view: To adjust the viewing format of the image.

Automatic: The images are shown in scale in relation to the size of the screen (the image may not be displayed in its entirety).

Function button: function

Full: The full images are displayed on the screen.

Display time: To adjust the display time of the images during a slideshow.

Repeat slideshow: The active slideshow will be repeated indefinitely.

Navigation¹⁾

Navigation, entry and control

Related video



Fig. 41 Navigation

Introduction

General information

The current vehicle position is determined by means of the GPS satellite system (Global Positioning System). Sensors in the vehicle measure distances that have been driven. The measurement values are compared with the detailed map data and the road information stored therein. Traffic reports, if any, will also be taken into account in the route calculation (dynamic route guidance **»» page 64**). Using all the data available, the Infotainment system calculates the optimum route to the destination.

The destination is defined by entering an address or a point of interest, e.g. a petrol station or hotel.

Spoken instructions and visual guidance on the navigation unit and on the instrument panel will direct you to your destination.

Depending on the country, some infotainment system functions can no longer be selected when the vehicle is travelling above a certain speed. This is not a malfunction, but simply a legal requirement.

Navigation messages

When the Infotainment system is unable to receive any data from GPS satellites (due to a dense tree canopy, underground car park), navigation can still continue using the vehicle sensors.

Possible navigation limitations

In areas that are not or are only partially digitised on the data storage device (e.g. insufficient definition of one-way streets and road categories), the Infotainment system will still attempt to provide route guidance.

If navigation data are unavailable or incomplete, the navigation system may be unable to determine the exact vehicle position. As a

result, the navigation may not be as exact as usual.

Navigation area and updating of navigation data

Roads and streets are subject to constant change (e.g. new roads, changes to street names and building numbers). Therefore, if the navigation data is not updated, then errors or inaccuracies may occur during guidance.

SEAT recommends updating navigation data on a regular basis. Up to date navigation data can be acquired at a SEAT dealer.

Use navigation data from a memory card.

✓ Only available for the model: **Navi System**

The SD card is initially to be found inserted in SD card slot 2.

To update navigation data visit our website: www.seat.com.

- Insert the memory card **»» page 46**.
- Do not remove the memory card while testing. Wait for the testing icon to disappear.

¹⁾ Valid for: Navi System and Navi System Plus.

If the inserted memory card contains valid navigation data, the following message appears: "The source contains a valid navigation database". It is now possible to navigate with the memory card data. When the memory card is no longer needed by the hardware, it will be prepared for removal » page 46.

Note

- The inserted memory card must be prepared before it is ejected» page 46.
- Press the infotainment **(MENU)** button » Fig. 1 **1** and then select the **Settings** context to open the **System settings** main menu.
- Navigation is not possible without the SD card.
- Do not remove the memory card while the navigation data is in use. This could damage the memory card!
- The navigation memory card may not be used as memory for other files. The infotainment system will not recognise the files saved.
- SEAT recommends only using original SEAT memory cards to use navigation data. The use of other memory cards could limit its operation.

Updating and installing navigation data

✓ Only available for the model: Navi System Plus

The Infotainment system is equipped with an internal navigation data memory. The required navigation data are already installed on the system.

The Infotainment system always requires the navigation data that is currently valid for this unit in order to allow all functions to be used in full. Using an old version may lead to errors during navigation.

Updating navigation data

To update navigation data visit our website: www.seat.com.

The navigation data must be installed after downloading. Navigation is not possible from the memory card.

Installing navigation data

The installation process takes about 2 hours.

If the Infotainment system is switched off, the installation process is paused and will automatically resume when switched back on.

- Switch the ignition on.

• Insert the memory card containing the navigation data » page 46.

• Press the Infotainment **(MENU)** button » Fig. 1 **1** and then select the **Settings** context.

• In the **System settings** menu, press the **(System information)** function button.

• Press **(Update software)** to import the stored navigation data.

• Follow the instructions displayed on the screen.

Once installed, the memory card can be removed. The memory card must be prepared for removal » page 46.

CAUTION

Do not remove the memory card while the navigation data is being installed. The memory card may be irreparably damaged!

Note

- The navigation memory card may not be used as memory storage for other files. The Infotainment system will not recognise the files saved on it.
- SEAT recommends a CLASS 10¹⁾ memory card for the use of navigation data. The use of other memory cards could limit its operation.

¹⁾ The speed class of an SD card.

Navigation main menu



Fig. 42 Navigation main menu

The navigation functions are only enabled when navigation data for the current area are available on the Infotainment system.

The *Navigation* main menu allows you to select a new destination, call up a previously used or stored destination and search for points of interest.

Opening the main Navigation menu

- Press the **NAV** button on the Infotainment system to open the last menu that was open in navigation.
- If the main *Navigation* menu is **not** displayed, press the **NAV** Infotainment button again until the main *Navigation* menu appears.

- **OR:** Press the **↵** function button to return, menu by menu, to the main *Navigation* menu.

Function buttons and messages on the main Navigation menu

Function button: function

- A** The split screen is displayed » page 63.
- B** Messages and function buttons on the map display » page 64.

NEW DESTINATION: To enter a new destination » page 58.

ROUTE: During route guidance » page 60.

MY DESTS.: To activate or manage stored destinations » page 60.

POI: Search for points of interest (car parks, fuel stations and restaurants) within a particular search area » page 62.

VIEW: To modify or activate or deactivate the split screen and show POI » Fig. 42 **A** » page 63.

SETTINGS: Open the **Navigation Settings** menu » page 67.

New destination (enter destination)



Fig. 43 Search screen.

- In the *Navigation* main menu, press the **NEW DESTINATION** function button.
- Press the **OPTIONS** function button and select the required type of destination (**Search, Address, POI on the route or On map**).
- Using voice control*, if you say Town, street and number, without pauses, and then the instruction “Start Route Guidance” a route to the given destination will start.

Search

Search for addresses and Points of Interest using the keypad to enter them » Fig. 43.

For cities, post codes and points of interest, the full details must be entered. You can also

search for points of interest by names or categories. When necessary, enter the name of the city to refine the search.

»» Fig. 43

A Press to open the cursor buttons (◀, ▶), which allow you to move within the text.

Address

After entering a country and a town, you can start navigating towards the centre of the selected town.

When narrowing down the destination address, **please note** that every entry restricts the available range of subsequent selections. For instance, if the street you are looking for is **not** in the postcode area you have selected in a previous window, you will not be able to find the street at the street selection stage.

Function button: function

Country: To select the desired country.

City: To enter the desired city or postcode.

Street: To enter the desired street name.

House number: To enter the desired house number.

Junction: To select the desired intersection.

Last destinations: Open the **My destinations** menu »» page 60.

Start: Start route guidance to the selected address.

Using the

- Select the destination on the map or enter it using GPS coordinates and confirm with **OK**.

Function button: function

Save: To save the selected point of interest in the destination memory »» page 60.

Edit: To edit a destination or to enter another destination.

Route options: To adjust route options, see **Navigation Setup** »» page 67.

Start: Starts guided navigation to the selected point of interest.

After starting route guidance

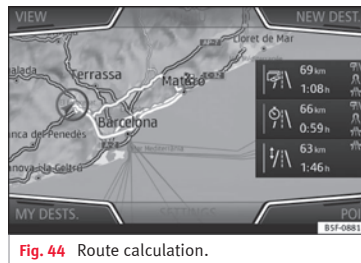

Fig. 44 Route calculation.

After starting route guidance, the route to the first destination will be calculated.

The calculation will be performed in accordance with the data selected in the **Route options** menu »» page 67.

After starting route guidance, three **alternative routes** will be suggested depending on the selected setup »» **Fig. 44**. These 3 routes correspond to the selectable route options: *Economical, Fast and Short*.

Route criteria: Meaning

Blue route: *Economical route*, the route is calculated by taking into consideration economic factors.

Red route: *Fastest route* to the destination, even if it is necessary to make a deviation.

Orange route: *Shortest route* to the destination, even if it results in longer travelling time. The route may have unconventional sections such as secondary roads.

- Select the desired route by pressing it.

The setting for the route criteria in the **Route options** menu is changed accordingly.

If no route is selected, then route guidance starts automatically after about one minute using the setting selected in the **Route options**.

Navigation announcements (audible recommendations for the driver)

Once the route has been calculated, the system gives the first navigation announcement. Up to 3 navigation announcements are given »»

before a turn, e.g. “Prepare to turn left”, “Turn left in 300 metres” and “Now turn left”.

- Press the right thumbwheel of the multi-function steering wheel to listen to the last navigation instruction.

The distances indicated largely depend on the type of road and the speed at which you are driving. For instance, navigation announcements are given much earlier on motorways than on urban roads.

Appropriate navigation announcements are also given on multi-lane roads, branching roads and at roundabouts, for example: “At the roundabout, take the second exit.”

A navigation announcement informs you when you have reached your “destination”.

A navigation announcement informing you that you have reached the “destination area” is given if the exact destination cannot be reached because it is located in a non-digitalised area. It also indicates the cardinal point and the distance to the previously defined destination. Navigation resumes “offroad”.

During **dynamic route guidance**, you receive information about reported traffic congestion on the route. An additional navigation announcement is given if the route is recalculated due to traffic congestion.

During a navigation announcement, you can change its volume using the  button

» **Fig. 1**  up to a predefined minimum or maximum volume. The following navigation recommendations will then be made at the adjusted volume.

For other adjustments to the navigation recommendations, see **Navigation announcements settings**. » page 67.

Note

If you miss a turning during route guidance and are currently unable to turn back, keep on driving until the navigation system offers a new route.

Note

The quality of the navigation recommendations given by the Infotainment system depends on the navigation data available and any reported traffic problems.

Route

In the *Navigation* main menu, press the  function button.



The  function button is only displayed with route guidance activated.

Function button: function

: Aborts current route guidance.

Function button: function

: To enter a new destination or a new stopover» page 58.

: To exclude a section (of 0.2 to 10 km in length) from the current route, e.g. to avoid congestion. To cancel the exclusion, press the  function button and then .

^{a)}: The map of the calculated route appears and by holding a finger on the route and dragging the finger across said map, the route is changed to the road(s) that you want and the new route is then recalculated.

: View route information for current route.

^{a)} Only available for the model: Navi System Plus

My destinations (destination memory)

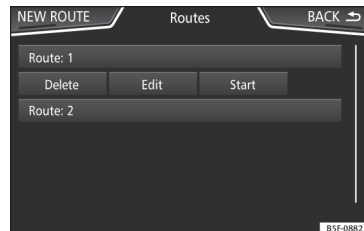

Fig. 45 List of stored routes.

The stored destinations can be selected from the **My destinations** menu.

- Press the **My dests.** function button in the main *Navigation* menu.

- Select the desired function button.

Store position, **Routes**, **Destinations**,
Last destinations or **Home address**.

Store position

- By pressing the **Store position** function button, the vehicle's current position is stored as a **Flagged destination** in the destination memory.

To permanently store the saved position as a **Flagged destination**, it must be re-named in the destination memory. Otherwise the stored position will be overwritten the next time a flagged destination is stored.

- Mark the **Flagged destination** in the destination memory.

- Press the **Store** function button.

The name can be changed in the following input window. Press the **in** function button to store the destination.

Routes

In the **Route** mode, you can define various destinations (final destination and stopovers).

The **starting point** of a route is always the current vehicle position determined by the Infotainment system. The **destination** is the

end point of a route. **Stopover destinations** are driven to before the destination.

- In the *Navigation* main menu, press the **My Dests.** function button.

- Press the **Routes** function button. The routes stored previously will appear

»» **Fig. 45.**

If you have not stored any routes or want to create a new route, press the **New route** function button and then follow the instructions as for a new destination, before pressing **Store**.

Pressing on a stored route brings up the following function buttons:



Function button: function



Delete: To delete a stored route.

Edit: To edit and store a route.



Start: To start route guidance.

Function buttons and indications in the New route or Edit route menu

Function button or message: function or meaning	
	Stopover.
	Destination.
	Estimated time of arrival at destination.

	Calculated distance to destination.
	Travelling time.
	Distance to the next stopover.

Press on the destination to display the function buttons.

	Delete destination.
	To start guidance direct to the selected destination. Destinations that come before the selected destination are ignored.
	To open the detailed view of the destination in question.

Available function buttons.

New dest.	To add a new destination to the tour.
Destinations	To add a new destination from My destinations to the tour.
Storing	To store the created tour in the tour memory.
Start	To start route guidance.
Calculate	To update calculated distance and estimated arrival time. ^{a)}
Stop	To stop route guidance to the active destination. ^{b)}

»»



To move a stopover or a destination to another position on the list. Press and drag to move the destination.

- a) This function button is only displayed with route guidance activated and when a destination has been added to the tour.
- b) This function button is only displayed with route guidance activated.

Last destinations

View of destinations for which a route has already been started.

My destinations

- Press the Options function button and select the desired function button.

Function button: function

Destination memory: View of destinations stored manually and from imported vCards » page 66, Importing vCards (electronic business cards).

Favourites: View of destinations stored as favourites.

Contacts: View of entries in the phonebook that have a stored address (postal address).

Home address

Only one address or position can be stored as the home address at any one time. The stored home address can be edited or overwritten.

If a home address has already been stored, route guidance will be started to the stored home address.

If a home address has not yet been stored, an address can be assigned as the home address.

Assigning the home address for the first time:

Position: Press to store the vehicle's current position as the home address.

Address: Press to enter the home address manually.

Editing the home address:

The home address can be edited in the **Navigation settings** menu » page 67.

Points of interest (POI)

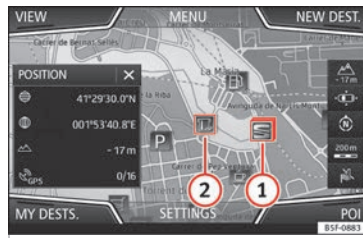

Fig. 46 Points of interest on the map.

The points of interest saved in the navigation data memory are divided into different point

of interest categories. Each point of interest category is assigned a symbol for display on the map.

If a database of points of interest has been imported into the Infotainment system, » page 66, **Importing Personal POI** the category **Personal POI** is also shown.

In the **Map settings** menu, the categories of points of interest to display on the map can be configured » page 67. Up to 10 categories of points of interest can be selected.

Selecting a point of interest on the map

Function button: function

- ① There are several points of interest in the area. Press this symbol to open a list of points of interest.
- ② The only point of interest in this zone. Press the symbol to open the detailed view of the point of interest.





Fast search for a POI

In the **Navigation** main menu, press the **POI** function button and the three main categories will appear. Alternatively, enter the name of the point of interest to be searched using the new destination keypad, or press **Search nearby** on the map. » table on page 63.

View

In the *Navigation* main menu, press the **View** function button.

Function button: function

2D 	Map display in two dimensions (conventional).
3D 	Map display in three dimensions (bird's eye view). Buildings are also displayed in three dimensions. The places of interest and well-known buildings are shown in detail and in colour.
	To display the destination on the map.
	To display the route on the map.
Auto / Day / Night	To change between day and night format.
Split screen	Press to display the split screen »» page 63.
POI	Display points of interest on the map.

^{a)} This function button is only displayed with route guidance activated.

Split screen

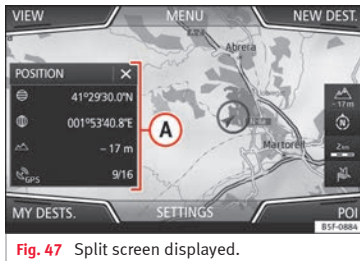

Fig. 47 Split screen displayed.

The split screen »» Fig. 47 **A** may display any of the information described below:

- Press on the name of the split screen to select a display option.

Function button: function

Audio: Indicates the selected audio source.

Compass: Displays a compass with the current travelling direction and indicates the current position of the vehicle (street name).

Manoeuvre: Displays a list of the next manoeuvres, POIs or TMCs on the route and pressing them brings up additional information

Most frequent routes^{a)}: Information on the user's most frequent routes.

Function button: function

Position: current vehicle position in coordinates and GPS status (satellite reception).

^{a)} This function button is only shown when route guidance is not active or when predictive route guidance is active.

Press the **X** function button to close the split screen.

At any moment during navigation, pressing inside the map will make a pop-up menu appear with the following functions:

Function button: function

Street name or coordinates: shows the details of the point selected on the map.

Only when you press on an icon on the map:

POI: name of the point of interest (when only one appears on the map).

Group of POIs: more points of interest (when you press on the map on various POIs grouped together).

Favourite: name of the favourite.

Home: Home address.

Start route guidance: starts guidance directly.

Add stopover destination: only when you have an active route.

Search nearby: enters in the search menu, but only for the area around the point selected on the map.



Function button: function

 (only when demo mode is active)

Map display

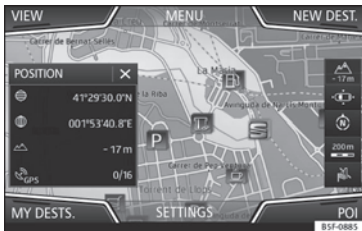







Fig. 48 Messages and function buttons on the map display.





Function buttons and messages on the map display.

To activate function buttons  and , press function button .

Function button: function

	Current altitude indicator.
	To centre the vehicle position on the map.
	To centre the destination on the map. This function button is only displayed if either <i>Display destination on map</i> or <i>Display route on the map</i> is selected » page 63.

Function button: function

	To change the orientation of the map (north-facing or direction of travel). This function is only available in 2D mode.
	View map scale. Turn the setup button or move your fingers together/apart on the touchscreen to change the scale of the map.
	To select automatic scaling. If the function is active, the symbol is displayed in blue.
	Briefly zooms in on the map. After a few seconds, it automatically returns to the last selected scale.
	It can mute or repeat the last announcement, or can change the announcement volume.

Road signs: Depending on the vehicle's equipment, the road signs stored in the navigation data are displayed [»](#) page 67.

Traffic reports and dynamic route guidance (TRAFFIC)



Fig. 49 Traffic reports

The Infotainment system constantly receives traffic reports (TMC/TMCpro) in the background, provided a TMC traffic news station can be received at the current location. The station being listened to does not have to be the traffic news station.

TMC traffic reports are displayed on the map with symbols [»](#) page 65, **Traffic reports on map (selection)** and are required for dynamic route guidance [»](#) page 65, **Dynamic route guidance**.

List of available traffic reports

- Press the Infotainment **MENU** button [»](#) **Fig. 1**  and then select the **Traffic** context.

Dynamic route guidance

In order for dynamic route guidance to function, **Dynamic route** must be activated in the route options »» page 67.

If during route guidance a traffic report is received that affects the route being travelled, an alternative route will be searched for if the Infotainment system calculates that time can be saved.

If it calculates that time will not be saved using the alternative route, it will continue on the route with the traffic congestion. An announcement will be made in each case.

Shortly before arriving at the announced congested traffic, it will be announced once again.

Avoiding congestion by following the instructions of a traffic report does not always save time as the alternate roads may be at a standstill. The quality of the dynamic route guidance depends on the information contained in the traffic reports.

The remainder of the route to be travelled may be manually excluded to cause a new route calculation »» page 60.

Traffic reports on map (selection)

Symbol: Meaning

 : Traffic congestion

Symbol: Meaning

 : Traffic jam

 : Accident

 : Slippery road surface (ice or snow)

 : Slippery road surface

 : Danger

 : Road works

 : Strong wind

 : Road closed to traffic

During route guidance, traffic congestion that does **not** affect the route calculated is displayed in grey.

The extent of the traffic congestion along the route calculated is shown by a red line.

Any incidents that affect the route calculated and have caused the route to be recalculated are displayed in orange.

The position of a symbol indicates the start of the traffic congestion if it is clearly defined in the traffic report.

Predictive navigation

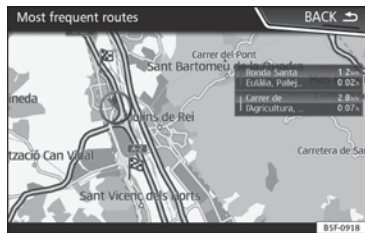

Fig. 50 Predictive navigation

When you activate Predictive navigation, the system detects and stores in the background routes that are frequently followed, without them being active destination routes. This function has no navigation announcements unless the user requires them by pressing the right thumbwheel of the multifunction steering wheel.

- On the main screen of the Navigation menu, in the pop-up window, press the **Frequent routes** button. To display frequently followed routes press the **Show on map** button »» Fig. 50.

Importing vCards (electronic business cards)

Importing vCards to the destination memory

- Insert the data storage device with the stored vCards or connect it to the Infotainment system »» page 37.
- Press the **SETTINGS** function button in the main *Navigation* menu.
- In the **Navigation settings** menu, press the **Import destinations** function button.
- Select the data carrier with the vCards saved in the list.
- Press **Import all vCards from this folder**.
- Confirm the import notice with the **OK** function button.

The saved vCards will now be in the destination memory »» page 60 and may be used for navigation.

Note

Only one address per vCard can be imported. In the event any vCards have multiple addresses, only the main address will be imported.

Importing Personal POI

Importing the Personal POI to a points of interest destination memory

- Insert the data storage device with the stored Personal POI or connect it to the Infotainment system »» page 37.
- Press the Infotainment **MENU** button »» **Fig. 1** ① and then select the **Settings** context.
- In the **Settings** menu, press the **Manage memory** function button.
- Press **Update my POIs** and then press **Update** and **Next** to import the Personal POIs.
- Confirm the import notification with the **OK** function button.

The stored Personal POI are now in the points of interest destination memory »» page 62 and can be used for navigation purposes.

The stored Personal POI can be deleted in the **Navigation Settings** menu »» page 67.

Navigation with images

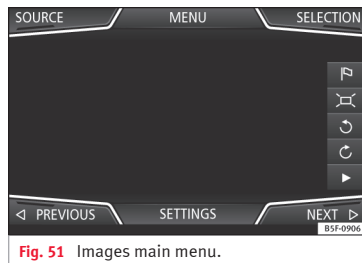

Fig. 51 Images main menu.

Selecting an image and starting route guidance

Bear in mind the requirements and formats of the compatible images »» page 37.

- Insert the data storage device with the stored images or connect it to the Infotainment system.
- Press the Infotainment **MENU** button »» **Fig. 1** ① and then select the **Images** context.
- Press the **SOURCE** »» **Fig. 51** function button and select the data storage device where the images are stored.
- Select the desired image.
- If the image displayed was taken using GPS localisation, the **📍** function button will appear. Press to start guidance to a destination.

Road sign indicators

The road sign indicators must be active in the **Navigation Setup** menu » page 67.

If road signs for the road being travelled are stored in the navigation data, the system can show them on the map display (e.g. a speed restriction).

Please bear in mind how recent the navigation data is and the limitations of the system » page 56 !

Traffic sign recognition

Some vehicles are also equipped with a camera for traffic sign recognition. If traffic sign recognition is installed in the vehicle and activated, the recognised traffic signs and additional information are displayed in the map view.

Read and take note of the information and indications provided by the traffic sign recognition system in the vehicle » **Booklet Instruction Manual**.

Route guidance in demo mode

If demo mode is activated in the **Navigation Settings** menu » page 67, an additional pop-up window opens when you start route guidance.

- Pressing the **Demo mode** function button starts a “virtual route guidance” to the destination you have entered.
- If you press the **Normal** function button, a “real route guidance” starts.

The sequence of events and the operations in virtual route guidance are similar to those in real route guidance.

Virtual route guidance is repeated when you reach the fictitious destination and always starts again from the starting point if **not** aborted beforehand.

If the starting point for demo mode has been defined manually in the **Navigation Settings** menu, virtual route guidance will start from the position set.

A manually entered starting point is overwritten with the current vehicle location if the vehicle moves off.

Note

Disable demo mode after use, otherwise you will be prompted to choose between virtual and normal route guidance each time you start route guidance.

Navigation settings

Settings

- Press the **SETTINGS** function button in the main *Navigation* menu.

Function button: function

Route options: To make adjustments to route calculation.

Suggest 3 alternative routes: After starting route guidance, 3 alternative routes are suggested » page 59.

Route: Select the route type.

Economical: The route is calculated by taking into consideration economic factors.

Fast: The fastest route to the destination.

Short: shortest route to the destination, even if it results in a longer travelling time.

Most frequent routes: Information on the user's most frequent routes.

Dynamic route: Dynamic route guidance is activated when a TMC is received » page 64.

Avoid motorways and highways: Motorways will be excluded from the calculation whenever possible.

Avoid ferries and motorail trains: Ferries and motorail trains will not be considered in the calculation of the route whenever possible.

Avoid toll roads: Toll roads will be excluded from the calculation whenever possible.

Avoid tunnels: Tunnels will be excluded from the calculation whenever possible. »

Function button: function

Avoid routes requiring toll stickers: Routes requiring toll stickers will be excluded from the calculation whenever possible.

Show available toll stickers¹⁾: To mark the available toll stickers on the list (**Avoid routes requiring toll stickers** must be active).

Roads requiring toll stickers that have been marked as having said toll sticker will be taken into account in the calculation of the route.

Include trailer: Calculate the route and arrival time for the vehicle with a trailer.

Map: To make adjustments to the visual display of the map.

Show road signs: The road signs stored in the navigation data for the road being travelled will be displayed during route guidance **»» page 67**.

Lane guidance: During route guidance, when driving and turning on multi-lane roads, an additional display is shown with lane guidance. This will only appear if there is information in the database for the area being driven in.

Show favourites: The stored destinations are shown on the map as favourites (★).

Show POI

Select categories for POI: To select which point of interest categories are displayed on the map **»» page 62**.

Show brand logos for POIs: View of category logos of the selected points of interest (e.g. view of petrol station logos).

Function button: function

Manage memory: To modify saved destinations.

Sort contacts: To select the sequential order of the entries in the phonebook that have (postal) addresses, see also **»» page 60**.

Define home address: To assign or edit a home address, see also **»» page 62**.

Delete my points of interest (POI): To delete the points of interest stored in the destination memory **»» page 66**.

Update my POIs: To update the stored points of interest **»» page 66**.

Import destinations (SD/USB): To import electronic business cards (vCards) into the destination memory **»» page 66**.

Delete user data: To delete the stored destinations (e.g., the **Last destinations** or the **Destination memory**).

Navigation announcements: To make adjustments to navigation announcements.

Volume: To adjust the volume for driving recommendations.

Entertainment fading (nav. announcements): Adjusting the volume of the active audio source during navigation instructions.

No voice guidance during call: No audible driving instructions will be given during a telephone conversation.

Note: My POIs: Audible announcement when nearing a point of interest.

Fuel options: To make adjustments relating to fuel.

Function button: function

Select preferred fuel station: The selected petrol station mark will be shown before other points of interest in the search.

Fuel warning: The warning to refuel is active.

If the fuel level reaches the reserve level, the corresponding warning is generated which permits the search for petrol stations.

Version information: Information on the stored navigation data.

Maximum speeds: Shows the speed limits, depending on the road, for the current country.

Advanced settings: To make advanced adjustments to the navigation.

Time display:  displayed during route guidance.

Estimated time of arrival: The estimated time of arrival at the final destination is displayed.

Duration: The estimated travelling time to the final destination is displayed.

Status line:  displayed during route guidance.

Destination: The distance calculated to final destination is displayed.

Next stopover: The calculated distance until next stopover is displayed.

Note: National border crossed: Displays the speed limits of the country in question when crossing the border.

Demo mode: When Demo mode is activated and route guidance is started, virtual guidance to the entered destination can be initiated **»» page 67**.

Function button: function

(Define demo mode starting point): if demo mode is activated, a fictitious starting point for virtual route guidance can be defined when the vehicle is stationary.

(Waypoint mode)^{b)}: To start Offroad navigation.

- a) This function depends on the country.
- b) Only available for the model: "Navi System Plus".

Navigation in Offroad mode*

Introduction

✓ Only available for the model: Navi System Plus

Offroad* navigation is a function for offroad driving that provides directions in "non-digitised areas" at low speeds.

Non-digitised areas are areas about which the system does not have information for the streets or terrain. It does not detect streets, buildings or natural limits such as mountains or rivers, although they may be shown on the map.

Offroad* navigation is not suitable for driving on conventional roads as it does not detect one-way streets, motorway entries or similar.

Offroad Navigation Menu

✓ Only available for the model: Navi System Plus

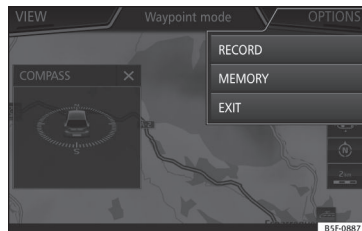

Fig. 52 Offroad Navigation Menu start

Press the **SETTINGS** function button in the main Navigation menu.

- In the menu, press the **Waypoint mode** function button.
 - The Offroad Navigation menu opens
- »» Fig. 52.

Function buttons in the Offroad Navigation menu

Function button: function

(RECORD): Initiates the plotting of an Offroad tour.

(MEMORY): Opens a list allowing the selection of a stored Offroad tour.

(EXIT): Ends Offroad navigation.

Recording an Offroad tour

✓ Only available for the model: Navi System Plus

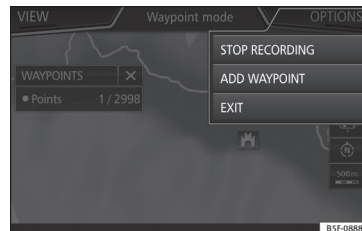

Fig. 53 Recording an Offroad tour

An Offroad tour is formed by a series of stored *waypoints*.

Starting recording

- In the Offroad Navigation menu, in the pop-up window press the **(RECORD)** pop-up button.
- In the pop-up window, the user is able to plot the tour with a given destination or start plotting the route without giving a final destination.
- Starts plotting the route.

The **offroad** markers can be recorded by indicating a manual waypoint. »»

- In the Offroad Navigation menu, press the **ADD WAYPOINT** function button. The tour waypoints defined manually are shown on the map by a marker.

Ending recording

- Press the **STOP RECORDING** function button in the main Offroad Navigation menu.

Managing stored Offroad tours

- ✓ Only available for the model: Navi System Plus

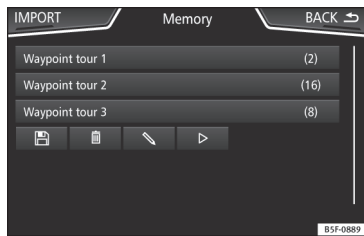

Fig. 54 Offroad Navigation menu, stored tours

- Press the **MEMORY** function button in the Offroad Navigation menu.
- A list of stored Offroad tours opens, if there are any.

When a tour is selected, the following icons will appear»» **Fig. 54:**

- 📁 Export the tour to an SD card.
- ✎ Edit the name of the tour.
- 🗑️ Delete the tour.
- ▶ Load tour

Function button: function

(IMPORT): allows the import of an Offroad route in “.GPX” format.

Loading an Offroad tour

When the Offroad tour is selected, press Play ▶ and the selected tour will be loaded onto the Navigation system.

Creating an Offroad tour

- ✓ Only available for the model: Navi System Plus

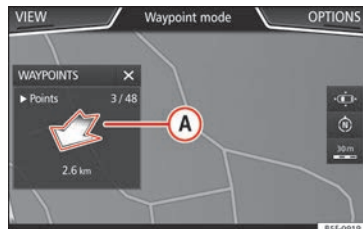

Fig. 55 Offroad route guidance mode

Start route guidance

- Loads the stored Offroad tour.
- Starting off in a stored route is not detected by the system automatically.

Setup

Function button: function

(Invert): Reverses the direction of the stored Offroad tour.

(Next point): Starts the Offroad tour from the nearest point.

(Start): Starts the complete Offroad tour.

When route guidance starts, the system switches to the map view.

Stopping route guidance

- Press the **(Options)** button on the screen and then press **(Stop)**.

End waypoint navigation

- Press the **(EXIT)** function button in the Offroad Navigation menu.

⚠️ WARNING

Terrain features are disregarded during route guidance Drive slowly and following the instructions in order to perform the manoeuvre as far as possible!

- The general direction of travel is indicated straight ahead by direction arrows in the Infotainment System pop-up window »» Fig. 55

A.

Note

If an Offroad tour is being recorded, this is automatically stored if Offroad navigation is discontinued.

CAR menu

Introduction to managing the CAR menu

CAR menu.

Press the Infotainment **(MENU)** button » **Fig. 1** **(1)** and then select the **Vehicle** context to access the main menu with the following options:

- VIEW
- MINIPLAYER, in the top right corner (Radio or Media function if the HDC descent control* is not active).
- PREVIOUS-NEXT (to change screen)
- SETTINGS » **Booklet Instruction Manual, chapter System setup (CAR)**

With the function button **(VIEW)** you can access the following information:

- SPORT*
- OFFROAD*
- CONSUMERS
- DRIVING DATA

- ECOTRAINER*
- VEHICLE STATUS

Sport*

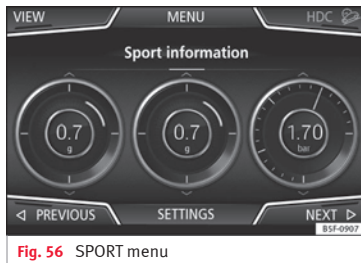

Fig. 56 SPORT menu



Fig. 57 Lap Timer SPORT menu

- Press the Infotainment **(MENU)** button » **Fig. 1** **(1)** and then select the **Vehicle** context.
- Press the **(VIEW)** function button and then select **SPORT**.

If the corresponding equipment is available, the information that appears in the Sport option is the following » **Fig. 56**:

1. Instantaneous power expressed in kW
2. G forces
3. Turbo pressure, expressed in bar ("bar"), kilopascals ("kPa") or in pounds per square inch ("psi"). Press the Setup button to change the units of pressure » **page 90**
4. Coolant temperature
5. Oil temperature

Only three of these items of information can be displayed at the same time, but the user chooses which to display, and in what order, by moving the finger vertically over the dials.

If the **(NEXT)** button is pressed, the **Lap timer**¹⁾ menu is displayed; this is described below » **Fig. 57**:

- (1)** Analogue lap timer.

¹⁾ This lap timer is independent of the one that appears on the instrument panel » **Booklet Instruction Manual**

- ② A new lap timer recording is started by pressing on the surface of the digital lap timer +.
- ③ Stop lap timer/Partial time.
- ④ The analogue lap timer stops for 5 seconds. After 5 seconds, the analogue lap timer goes back to showing the real time.
- ⑤ Statistics/delete last lap timer recording.

Offroad*



Fig. 58 CAR Menu Offroad.

- Press the Infotainment **(MENU)** button
 »» Fig. 1 ① and then select the **Vehicle** context.
- Press the **(VIEW)** function button and then select **OFFROAD**.

If the corresponding equipment is available, the information that appears is the following:

1. Compass.
2. Altimeter: altitude above sea level.
3. Turning angle of steered wheels.
4. Coolant temperature.
5. Lubricating oil temperature

Only the altimeter and 2 more of these items of information can be displayed at the same time, but the user chooses which to display, and in what order, by moving their finger vertically over the dials.

Consumers

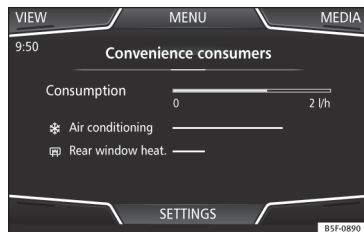

Fig. 59 Convenience consumers.

By pressing the **(CONSUMERS)** button, information on the status of the vehicle's main consumption devices is obtained. It is shown via a consumption indicator bar in l/h (gal/h)¹⁾.

Driving data



Fig. 60 Driving data.

The onboard computer is equipped with 3 memories that work automatically. In these memories you can see the distance travelled, average speed, time passed, average consumption and autonomy of the vehicle.

1. Since start

Indicates and stores the values of the journey completed and the consumption from when »

¹⁾ In the case of Gas (CNG) vehicles, the units are in kg/h.

the ignition is switched on to when it is switched off.

2. Since refuelling

Display and storage of the values for the journey and the consumption. By refuelling, the memory will be erased automatically.

3. Long-term

The memory records the values for a specific number of partial trips, up to a total of 19 hours and 59 minutes or 99 hours and 59 minutes, or 1999.9 km (or miles) for 9999 km (or miles), depending on the model of instrument panel.

When one of these values is reached (depending on the version of the instrument panel), the memory is automatically deleted and it starts counting from 0 again.

Ecotrainer*

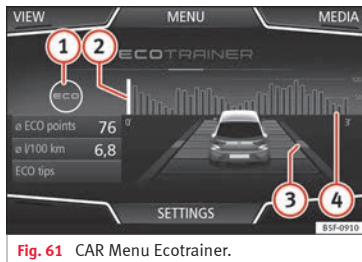

Fig. 61 CAR Menu Ecotrainer.

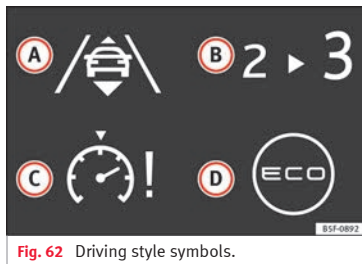

Fig. 62 Driving style symbols.

Open ECOTRAINER menu

- When the vehicle is stopped, press the Infotainment **(MENU)** button »» Fig. 1 ① and then select the **Vehicle** context.
- Press the **(VIEW)** function button and then select **ECOTRAINER**.

If the corresponding equipment is available, the ECOTRAINER will provide information on driving style. The information on driving style is only evaluated and displayed when moving forward.

Ø ECO points: Driving style display

This indicates the driving style since starting the vehicle on a scale of 0 to 100. The higher the score displayed, the more efficient the driving style. To see more information, press the display. It shows statistics for the last 30 minutes of driving since starting the vehicle. If the car has not yet been driven for 30 minutes, it shows values from the last trip in grey.

Ø l/100 km: Average fuel consumption

Shows the average fuel consumption. The value is calculated by using the kilometres covered since starting the vehicle. To see more information, press the display. It shows statistics for the last 30 minutes of driving since starting the vehicle. If the car has not yet been driven for 30 minutes, it shows values from the last trip in grey.

ECO tips: Tips on how to save fuel

By pressing the **(ECO tips)** function button, you can view tips on how to save fuel. These tips can only be viewed when the vehicle is stopped.

Evaluation of efficient driving style

The efficiency of the driving style is reflected by different elements on the display.

Display » Fig. 61: Meaning

- ① Different symbols are shown on the left of the columns that report on the current driving style » table on page 75.
- ② The white column is an indication of where the efficiency graph begins (from left to right). It shows the position of the evaluation that is currently being performed.
- ③ Bars to represent acceleration. The position of the car represents the acceleration. If speed is constant, the car remains in the central area. When accelerating or braking, the car moves forward or backward respectively.
- ④ Columns to show driving style efficiency. On the horizon, the columns represent the efficiency of the driving style in a retrospective manner and move from left to right every five seconds or so. The higher the height of the columns, the more efficient the driving style. The colour of the sky represents the average of the last three minutes. The colour changes from grey (less efficient) to blue (more efficient).

Symbols » Fig. 62: Meaning

- A Foresight when driving. If sudden changes of acceleration occur, driving style efficiency is reduced.
- B Gear-change indicator.

Symbols » Fig. 62: Meaning

- C The current vehicle speed is having a negative impact on fuel consumption.
- D Ecological driving style.

Vehicle status



Fig. 63 Standard representation: vehicle status.



Fig. 64 Standard representation: vehicle status.

Press the **Vehicle status** button to access information on the **Vehicle status** messages and **Start-Stop System**. The Vehicle status messages are displayed » Fig. 63, in addition to being specified on the corresponding button.

Depending on the parts affected by these messages, they will be indicated in different colours (depending on their significance) in the vehicle display.

To access the **Tyre Pressure Monitoring System** you must press the **Previous** or **Next** buttons.

From this same menu, using the button **SET**, the tyre pressures are stored.

Note

The values that appear in the figures » Fig. 59, » Fig. 60, » Fig. 63 and » Fig. 64 »

are indicative and may vary depending on the features.

Telephone management system (PHONE)

Introduction to the telephone management system

Related video



Fig. 65 Telephone management system

General information

The Telephone functions described below can be used through the Infotainment system if there is a mobile telephone connected to it via Bluetooth® » page 79.

In order for the mobile telephone to be able to connect to the Infotainment system the telephone must be equipped with **Bluetooth®**.

If there is no mobile telephone connected to the Infotainment system, the telephone management system will not be available.

The instructions shown on the screen for the telephone menus will depend on the mobile telephone used. There may be variations.

Only use compatible Bluetooth® devices. For further information on compatible Bluetooth® products, ask your nearest SEAT dealer or check on the internet.

Use the instruction manual of the mobile telephone and of any accessories.

If you detect any operating issues between your mobile telephone and the Infotainment system, restart your mobile by switching it off and on again.

You may experience poor reception or may be cut off in areas where the signal is weak.

Most electronic devices are shielded against HF (high-frequency) signals. In any case, the electronic equipment may not be protected from the HF signals of the telephone management system. This may cause interference.

⚠ WARNING

Speaking by telephone and operating the mobile telephone whilst driving can distract you from the road and cause an accident.

- Always drive carefully and responsibly.
- Select volume settings that allow you to easily hear signals from outside the vehicle at all times (e.g. emergency services sirens and horns).

- In areas of little or no coverage or, in some cases, in a tunnel, garage or underpass, your call may be cut off and you may not be able to make even emergency calls.

⚠ WARNING

If a mobile telephone is not secured or is incorrectly secured in the vehicle, it could move around the passenger compartment in the event of a sudden driving manoeuvre or emergency stop, resulting in injury.

- While the vehicle is in motion, always secure the mobile telephone properly outside the airbag deployment zone.

⚠ WARNING

Mobile telephones may interfere with and alter the correct operation of pacemakers if they are carried directly over them.

- Maintain a minimum distance of at least 20 centimetres between the aerials of the mobile telephone and the pacemaker, as mobile phones may affect the functioning of pacemakers.
- Do not carry your switched-on mobile telephone in your breast pocket directly over the pacemaker.
- If you suspect interference, switch off the mobile telephone immediately.

»

ⓘ CAUTION

High speeds, poor weather or road conditions and the quality of reception can all affect the quality of a telephone conversation in the vehicle.

ⓘ Note

- Restrictions on the use of devices using Bluetooth® technology may apply in some countries. For further information, contact the local authorities.
- If you wish to connect a device to the telephone management system via Bluetooth® technology, consult the safety warnings in its instruction manual. Only use compatible Bluetooth® devices.

Areas where special regulations apply

Switch off the mobile telephone and the mobile Bluetooth function in places with a risk of explosion. In the majority of cases, these places are signposted, but not always clearly » **⚠** in General information on page 77. They include, for example:

- the vicinity of chemical pipelines and tanks
- The lower decks of boats and ferries.
- In the proximity of vehicles that run on liquid gas (such as propane or butane).

- places where the air is laden with chemicals or particles such as flour, dust or metal powder.
- all other places where the vehicle engine must be switched off.

⚠ WARNING

Switch off the mobile phone in areas with a risk of explosion! The mobile telephone can automatically connect to the mobile telephone network again if it loses the Bluetooth® connection to the telephone management system.

ⓘ CAUTION

In areas where special regulations apply or the use of mobile telephones is prohibited, both the telephone and the telephone management system must be switched off. The radiation produced by the mobile telephone when switched on may interfere with sensitive technical and medical equipment, possibly resulting in a malfunction or damage to the equipment.

Bluetooth®

Bluetooth® technology allows a mobile telephone to be connected to your vehicle's telephone management system. In order to use the telephone management system with a mobile telephone with Bluetooth® technology, it is first necessary to pair them.

Some Bluetooth® mobile telephones detect and automatically connect when turning on the ignition if a connection has been previously established. For this to take place the telephone must be switched on and its Bluetooth® function activated, and there must be no active Bluetooth® connection with other devices.

Bluetooth® connections are free.

Bluetooth® is a registered trademark of Bluetooth® SIG, Inc.

Bluetooth profiles®

When a mobile phone is connected to the telephone management system, a data exchange takes place via one of the Bluetooth® profiles.

- **Hands-free Bluetooth profile (HFP):** If a mobile telephone is connected to the telephone manager through the HFP, calls can be made wirelessly through the hands-free device. This function also requires other Bluetooth profiles such as the phonebook download and instant messaging.
- **Audio profile (A2DP):** Bluetooth profile for transmitting audio signals with stereo quality. This function can also connect other additional Bluetooth profiles for viewing tracks and for controlling playback on the mobile device.

Note

To prevent them from being heard through the speakers, the button and mobile telephone alert tones must be disconnected. Where necessary, disconnect the headset from the mobile telephone you wish to connect to the system.

Pair and connect a mobile telephone to the Infotainment system

In order to manage a mobile telephone via the Infotainment system, it is necessary to pair both devices **once**.

For your safety, we recommend you make the link when the vehicle is stationary. In some countries it is not possible to perform the pairing with the vehicle running.

Conditions

You must guarantee the following setup in the mobile phone and the Infotainment system:

- The ignition must be switched on.
- The **Bluetooth® function** of the mobile telephone and the Infotainment system must be active as well as visibility.
- The **keypad lock** on the mobile telephone must be deactivated.

Follow instructions in the manual for the mobile telephone.

After turning on the ignition, the visibility of the **Bluetooth® function** activates.

During the pairing process it is necessary to enter data via the mobile telephone's keypad. To do so, the mobile telephone must be ready.

Starting mobile telephone pairing

- Make sure the Bluetooth function of the mobile device is active and visible.
- Press the Infotainment **(MENU)** button **»» Fig. 1 ①** and then select the **Telephone** context.
- Press the **(Find telephone)** function button and then **(Results)**.

OR:

- Press the Infotainment **(MENU)** button **»» Fig. 1 ①** and then select the **Telephone** context.
- Press the **(SETTINGS)** function button.
- Press the **(Select mobile phone)** function button and then **(Results)**.

OR:

- Press the Infotainment **(MENU)** button **»» Fig. 1 ①** and then select the **Telephone** context.
- Press the **(Settings)** function button.

- Press the **(Bluetooth)** function button.
- Press the **(Find devices)** function button and then **(Results)**.

OR:

- Connect from the mobile device itself.

The name of the Bluetooth function of your Infotainment system will be displayed in the main **PHONE** screen and you can edit this via the **(Bluetooth settings)** menu **»» page 87**

The search process can take up to 1 minute. On the screen the system will dynamically update the names of the Bluetooth devices found.

As soon as the search is completed, the names of the Bluetooth® devices found are displayed on-screen.

- In the Infotainment system select the mobile telephone to which you want to connect from the list of Bluetooth devices found. In certain circumstances, it is possible that to finish the connection between the two devices, you must enter additional data in the mobile telephone and Infotainment system.
- If necessary, confirm the link to the mobile telephone.
- Use your mobile telephone to enter and confirm your PIN code, as indicated in the display of the infotainment system.

OR:



- Compare the PIN code shown on the display of the Infotainment system with that shown on the mobile telephone. If they match, confirm on **both** devices.

The infotainment system and the mobile telephone will now be connected to each other.

When the pairing has been finalized correctly, the *PHONE* main menu will appear. The phonebook and call lists stored in the mobile phone will be loaded once the requests have been accepted in the mobile phone. The duration of the loading process depends on the amount of data stored on the mobile telephone. After loading, the data will be available on the Infotainment system.

Pairing and connection of mobile telephones



You can pair up to 20 mobile telephones to the Infotainment system, but there can only be two mobile phones simultaneously connected as hands-free, and a third device as BT audio at any time.

When the Infotainment system is switched on, it automatically connects to the last connected mobile telephone. If it is not possible to connect to this mobile telephone, the telephone management system will try to automatically connect to the next mobile telephone on the list of paired devices.

The **maximum** range of the Bluetooth® is approximate. **10 metres**. The active Bluetooth® connection disconnects if this distance is ex-

ceeded. The connection is **automatically** re-established as soon as the device is once again within Bluetooth® range.

If the maximum number of paired devices is reached and you wish to pair another one to the system, it will automatically replace the one least used recently. If you wish to replace it with another one, the user must erase it beforehand. To do so:

- Press the Setup button on the device while in telephone mode.
- Press the function button .
- Activate the  function button.
- In the list of paired devices, press the  function button next to the mobile telephone to be deleted and then press **Delete** to confirm the process.

Note

- **It may be necessary to confirm the phonebook data transfer request on the mobile telephone.**
- **Check that there are no requests pending acceptance in your mobile phone. If there are, this could block some of the functions in the PHONE menu.**

Description of the telephone management system

Introduction

Some functions and setup can only be performed when the vehicle is stopped and are not available on all mobile telephones.

With the help of the telephone manager, up to 3 mobile telephones can be connected to the Infotainment system via the Bluetooth profiles (for example, one used as a Bluetooth-audio player and/or another two as hands-free telephones).

Note

- **Using a mobile telephone inside the vehicle may provoke noise in the speakers.**
- **Some networks may not recognise all language characters or offer all services.**

PHONE main menu



Fig. 66 PHONE main menu (view of the 8" screen).

Assign a user profile

The data from the phonebook, the call lists and the stored speed dial buttons are assigned to a user profile and remain stored on the telephone management system. This information will be available every time the mobile telephone is connected to the telephone management system.

After the first connection, it will take a few minutes for the data from the phonebook of the linked mobile phone to be available in the Infotainment system. The next time that the mobile telephone is connected (e.g. on the next journey) the phonebook is updated automatically.

If any entries in the mobile phonebook have been modified while connected, a manual update of the phonebook data can be initi-

ated from the **User profile settings** menu » page 87.

Telephone management can store a maximum of 4 user profiles for mobile telephones. If you wish to link/connect another mobile phone, the oldest user profile will automatically be replaced.

Telephone management system function buttons

- Press the infotainment **(MENU)** button » Fig. 1 ① and then select the **Telephone** context to access the *PHONE* main menu.

Function button: function

SMS	To open the menu for SMS messages » page 85.
CALLS	To open call lists of the connected mobile telephone » page 86.
SETTINGS	To open the Telephone settings menu » page 87.

Function button: function

①	Name of connected mobile telephone. Press the icon to the left to connect or pair with another mobile telephone.
②	Speed dial buttons, to which telephone numbers from the phonebook may be assigned respectively » page 86.
③	Change to another connected telephone: Allows user to change between connected telephones as hands-free. This button will only be visible when there are two telephones connected as hands-free. The active user profile corresponds to the telephone appearing on the screen.
DIAL NUMBER	To open the number pad and enter a telephone number » page 83.
CONTACTS	To open the phonebook of the connected mobile telephone » page 84.

Display and symbols of the telephone management system



Fig. 67 Active call.



Fig. 68 Simultaneous calls.

Display: Meaning » Fig. 67

- A** Name of the mobile network operator (provider) to which the mobile telephone is connected.

Display: Meaning » Fig. 67

- B** View of stored telephone number or name. If the name stored in the phonebook has an assigned photo, it can be displayed » page 87.
- Press to **accept** a call.
- Press to **end** a call.
- OR:** Press to **reject** an incoming call.
- Press to mute or to reactivate the ring tone during an incoming call.
- Press to mute the microphone during an active call and to reactivate it.
- This button keeps the call active. While the call is on hold the listener will not hear the conversation. To reactivate it, press the call accept button . To reject it, press the reject button .
- Press to add a participant to the active call.
- Charge status of a mobile telephone connected via "Hands-free profile" (HFP) Bluetooth®.
- Strength of coverage signal received by the mobile telephone.

Private mode

Private mode can only be activated during an active call.

To activate private mode:

- **Settings** menu.

- Uncheck the checkbox: **Hands-free telephone**.

With the private mode activated the active audio and microphone become that of the mobile phone connected to the hands-free. When deactivated, the audio reverts to the vehicle's audio system. This configuration is only applicable to the active call, so for subsequent calls, the audio will revert by default to vehicle's audio system.

Multiple calls

The telephone management system allows the user to interact with a maximum of three calls on the screen.

Only one of the calls may be active.

Simultaneous calls

The user can merge various calls into a conference call by pressing the button. To do this there must be at least two calls. Once the conference call has begun, the user can add up to a maximum of 5 participants.

Once the conference call has been set up, the user can consult the list of participants by pressing the Simultaneous calls image » Fig. 68 **C**.

Depending on the mobile device, you can hang up the call with one of the conference call participants or remove them from it while keeping them on a separate call.

WARNING

Remember that the driver must not operate the mobile telephone while driving.

Note

Multiple call and simultaneous call functions are subject to the services associated with the user's SIM card.

Enter telephone number menu



Fig. 69 Enter telephone number menu.

Open the Enter telephone number menu

Press the **DIAL NUMBER** function button from the *PHONE* main menu.

Possible functions

Enter telephone number	<p>Entering a phone number with the keypad.</p> <p>Press the OK function button to make a call.</p>
Select a contact from the list	<p>Enter the first letters of the contact to find using the keypad. The available entries appear in the phonebook.</p> <p>Select the desired contact from the phonebook to make the call.</p>
Redial	<p>Press button 1 »» Fig. 69 and the last number dialled will be shown on the display. To make a call, press the 1 button again.</p>
Enter the country code	<p>To enter a country code, instead of the first two digits (international access code e.g. "00") you can enter the character "+".</p> <p>Press the 0 button for approx. 2 seconds to add the +.</p>
Assistance call	<p>Press the function button to obtain help in the event of breakdown. For this the network of SEAT dealerships is available to you with their Mobile Service.</p>
Information call i	<p>Press the function button to obtain information on the SEAT brand and the additional services contracted related to traffic and travel.</p>

Possible functions

Call mailbox	<p>Press the Voicemail function button to make the call.</p> <p>OR: Press the OK function button for approx. 2 seconds to make the call.</p> <p>If the number for the mailbox has not yet been stored, enter it and confirm with OK.</p>
---------------------	--

Note

Breakdown service and information calls can incur an additional cost on your telephone bill.

Phonebook Menu (contacts)

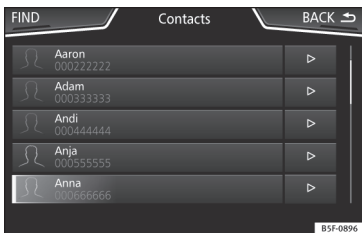

Fig. 70 Contacts Menu.

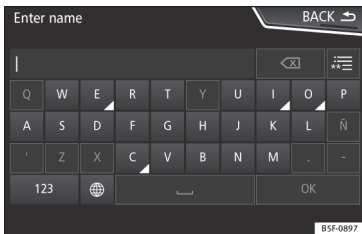

Fig. 71 Search window.

As soon as the first pairing is performed, it may take some time for the phonebook¹⁾ data from the paired mobile telephone to be available on the Infotainment system. De-

pending on the volume of data to be transferred, the process can take several minutes. It may be necessary to confirm the data transfer on the mobile telephone.

The phonebook can also be opened during a telephone call.

If the name stored in the phonebook has an assigned photo, it can be displayed in the list next to the name »» page 87, **Telephone settings**. For this purpose the option **Show pictures for contacts** must be activated in the **Phone settings** and your mobile phone must support this function (check the compatibility list).

In the *PHONE* main menu, press the **Contacts** function button to access the phonebook.

Possible functions

Select a contact from the list

Search the list and press the desired contact to make the call.

OR: If the contact has several telephone numbers, first press the contact and then the number to be used to make the call.

Possible functions

Searching for a contact in the search window

Press the **Search** »» Fig. 70 function button to open the search window.

Enter the name of the contact to be searched for in the window »» Fig. 71. As the characters are entered, a contact is displayed in the input field.

The number of matching results is displayed to the right of the input field. Press the function button to change to the list.

Search the list and press the desired contact to make the call.

Opening the detailed view of a contact

Press the **▶** function button »» Fig. 70 located next to the entry in contacts.

All the telephone numbers are displayed in the detailed view, and where applicable, the address recorded for the contact in question.

Read contact name

Press the **🗨** function button on the detailed list for the voice control system to say the contact name.

Dialling a contact

Press the desired telephone number on the detailed list to make the call.

Press the **✎** (pencil) icon to edit the number before calling.

¹⁾ Depending on the device, only the contacts from the telephone memory are loaded.

Possible functions

Send an SMS to a contact	Press the  function button in the detailed list.
Starting route guidance to the address of a contact^{a)}	If the address details of a contact have been stored, route guidance can be started for the address of the contact. Press the address data on the detailed view to start route guidance.

^{a)} A system with a navigation function is required.

Note

If you edit the number before calling, this will only be used for the call and will not be stored in the phonebook.

Short messages menu (SMS)

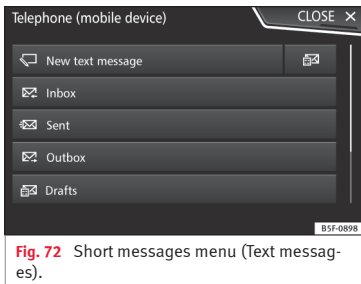



Fig. 72 Short messages menu (Text messages).

If the mobile phone connected to the HFP profile also supports the SMS profile, a new function button will appear in the top left-hand corner of the *PHONE* menu, which will allow SMS messages to be received, viewed and sent by the Infotainment system.

The proper operation of the functions mentioned above will depend on the compatibility of the connected mobile telephone.

Buttons on the Short messages (SMS) menu

- From the *PHONE* main menu, press the  function button.

Function button: function

New text message	To write and send a text message (includes the possibility of accessing templates with predefined messages).
Inbox	To open the received text messages folder.
Outbox	To open the outbox folder. This is where any unsent text messages are stored.
Sent	To open the sent text messages folder.
Drafts	To select a stored unsent message.
Send contact details	To send the details of a contact from the phonebook.

Possible function buttons for the submenus

Function button: function

Read	In order for the speech control system to play the text message.
Options	Open the Options menu.
Reply with template	To select a text template from a list.
Delete current text message	Deletes the text message from the Inbox .
Display telephone number	Displays the sender's telephone number.
Forward	To forward a text message.
Reply	To reply to an incoming text message.
Enter number	To enter a telephone number or to select a recipient from the phonebook. Press the  function button to select multiple recipients.
Recipients	To select multiple recipients from the phonebook.
Delete	To delete a text message.

Call Menu (call lists)

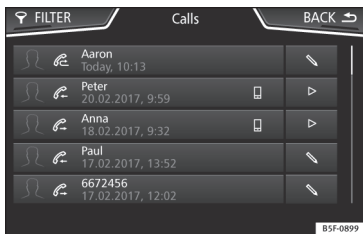

Fig. 73 Call lists menu.

- In the *PHONE* main menu, press the **Calls** function button.
- Press the **FILTER** function button.
- Select the desired call list: **All**, **Missed**, **Dialled** or **Received**.

If a phone number has been stored in the phonebook, the call list will display the name stored instead of the number.

If the name stored in the phonebook has an assigned photo, it can be displayed in the call list next to the name » **page 87**.

Possible displays in the Calls menu

Display: Meaning

-  **Missed calls**: Displays the numbers of missed and unanswered calls.

Display: Meaning

-  **Dialled numbers**: Indicates the numbers dialled on the mobile telephone and on the Infotainment system telephone management system.

-  **Received calls**: Indicates the numbers of the calls received on the mobile telephone and on the Infotainment system telephone management system.

Note

The availability of the call lists will depend on the mobile phone used.

Speed dial buttons



Fig. 74 PHONE main menu.

The speed dial buttons » **Fig. 74** ① may each be used to store a telephone number from the phonebook.

If the name stored in the phonebook has an assigned photo, it can be displayed on the speed dial button » **table on page 86**.

All the speed dial buttons must be manually edited and will be assigned to a user profile. Up to 12 contacts can be added to the quick dial buttons.

Possible functions

Assigning speed dial buttons

Press a **free** speed dial button from the *PHONE* main menu.

Select the desired contact from the list. If the selected contact has several telephone numbers, select the desired number.

Editing assigned speed dial buttons

Press and hold a **used** speed dial button in the *PHONE* main menu until the *Contacts* menu opens.

Select the desired contact from the list. If the selected contact has several telephone numbers, select the desired number.

To close the *Contacts* menu without applying the changes, press the **BACK** function button.

Deleting assigned speed dial buttons

The telephone numbers stored in the speed dial buttons can be deleted in the menu **User profile settings > Manage favourites** » **table on page 87**.

Possible functions

Dialling with speed dial buttons

Briefly press an **assigned** speed dial button from the *PHONE* main menu to call the telephone number that has been stored on it.

Note

The contacts stored on the speed dial buttons **DO NOT** update automatically. If a contact stored on a speed dial button is modified on the mobile telephone, the speed dial button will need to be reassigned.

Telephone settings

Press the **SETTINGS** function button from the *PHONE* main menu.

Function button: function

Select mobile phone: From the list, select the mobile telephone to be connected to the hands-free profile with the Infotainment system.

OR: Press **Find telephone** to connect a new mobile telephone.

Bluetooth: Open the **Bluetooth settings** menu
» page 87.

User profile: Open the **User profile settings** menu
» page 87.

Bluetooth® settings

In the *PHONE* main menu, press the **SETTINGS** function button and then the **Bluetooth** function button.

Function button: function

Bluetooth: Press to deactivate Bluetooth®. Disconnects all active connections.

Visibility: Activation and deactivation of Bluetooth® visibility.

Visible: Bluetooth® visibility is active.

Hidden: Bluetooth® visibility is deactivated. Bluetooth® visibility must be active for the external pairing of a Bluetooth® device with the Infotainment system. If you have a Bluetooth audio device active and playing, the visibility is automatically set to **Hidden**.

Name: Viewing and changing the name the Bluetooth® of the Infotainment system. This will be the name displayed to other Bluetooth® devices.

Paired devices: Displays paired devices. To disconnect and connect Bluetooth® devices and Bluetooth® profiles.

Find devices: Search for visible Bluetooth® devices within the range of the Infotainment system. The **maximum** range is approx. **10 metres**.

Bluetooth audio (A2DP/AVRCP): This function must be active if it is necessary to connect an external audio source via Bluetooth® to the Infotainment system. » page 48.

User profile settings

In the *PHONE* main menu, press the **SETTINGS** function button and then the **User profile** function button.

Function button: function

Manage favourites: Editing speed dial buttons.

Speed dial button in use: Press to delete the stored number.

Speed dial button free: Press to assign a number from the phonebook to the speed dial button in question.

Mailbox number: To enter or edit the voicemail number.

Sort by: To set the order of appearance of the entries in the phonebook (**Forename** and **surname** or vice-versa).

Import contacts: Press to import the phonebook of the connected telephone, or to update the imported phonebook.

Reminder: remember your mobile phone: If there is already an active Bluetooth® connection with another mobile telephone when turning off the ignition, the following message appears: "**Remember your mobile phone**".

Show pictures for contacts^{a)}: If phonebook contacts have been stored with a photograph, it can be displayed on the speed dial buttons, on the call lists and in the phonebook.

^{a)} Depending on the mobile phone.



Note

Some telephones need to be restarted to re-download the most recent contacts added.

Connectivity Box* / Wireless Charger*

Fig. 75 In the centre console: pad for connecting a mobile phone.

The Connectivity Box includes different functions that will help to use your mobile device.

They are the “Wireless Charger” and the “Mobile Signal Amplifier”.

The Wireless Charger only features the “Wireless Charger” function.

“Wireless Charger”

The “Wireless Charger” allows mobile devices with Qi¹⁾ technology to be charged without a cable.

To charge your mobile phone wirelessly:

- Place your mobile device with Qi technology¹⁾ in the middle of the pad with the screen facing up »» Fig. 75.

When you do so, make sure there are no objects between the pad and the mobile phone.

The mobile phone will start charging automatically. For further information about whether your mobile device uses Qi technology, please check your mobile phone's user manual or visit the SEAT website.

“Mobile Signal Amplifier”

The “Mobile Signal Amplifier” allows you to reduce the radiation in your vehicle and enjoy better reception.

For safety reasons, it is recommended that you pair the radio and the mobile device using Bluetooth® and place the mobile phone on the Connectivity Box pad, so as to have better reception without having to handle the mobile phone.

To establish a connection with the vehicle's external aerial:

- Place your mobile device in the middle of the pad with the screen facing up »» Fig. 75.

When you do so, make sure there are no objects between the pad and the mobile phone.

Your mobile phone will automatically be ready to make use of the external aerial.

WARNING

The mobile phone may heat up due to the wireless charging. Think about the temperature of your device before you pick it up, and take care when removing it.

Note

- Your mobile device must support the Qi wireless inductive charging interface standard for proper operation.
- If your mobile phone has a cover or a protective casing, this may affect the Connectivity Box functions.
- There must be no metallic objects between the pad and the mobile device that might affect the wireless charging or the connection with the external aerial.

¹⁾ Qi technology allows you to charge your mobile phone wirelessly.

- The charging time and the temperature vary in accordance with the device used.
- To avoid malfunction, ensure that the mobile phone is correctly placed on the pad.
- The maximum charging capacity is 5 W.
- Qi technology does not allow you to charge more than one mobile device simultaneously.
- No improvement in the transmission quality can be guaranteed if there is more than one mobile phone on the pad.
- You are advised to keep the engine running to guarantee proper wireless charging of your device.
- When a telephone with Qi technology is connected by USB, the charging will be performed through the medium specified by each mobile device manufacturer.

Setup

Menu and system settings

Main menu System settings

The selection of possible settings will depend on the country, the unit in question and the vehicle equipment.

- Press the Infotainment **(MENU)** button **»» Fig. 1 ①** and then select the **Settings** context.
- To adjust the settings for a certain function, press the appropriate function button in the main menu. Changes are automatically stored when a menu is closed.

Function button: function

Screen: To perform screen setup.

Select display mode: Grid or Carousel.

Switch off screen (in 10 seconds): If this function is active and the Infotainment system is not in use, the screen will switch off after approximately 10 seconds. Pressing the screen or pressing one of the Infotainment system buttons will switch the screen back on.

Brightness: To select the brightness level of the screen.

Day/Night: To select the display type (**Day**, **Night** or **Automatic**).

Function button: function

Touchscreen tone: Confirmation tone for pressing a function button is activated.

Show clock in standby mode: In standby mode, the current time is shown on the Infotainment system display.

Date and time: To alter the time and date.

Clock time source: To select the time source (GPS or manual).

GPS: The date and time can be selected using the **Time zone** function button. In this case, the **Date** and **Time** function buttons for manually entering the data will not be active.

Manually: The date and time can be manually adjusted using the **Date** and **Time** function buttons.

Time: To manually alter the time.

Time zone: To change to the desired time zone.

Time format: To select the time display format (12- or 24-hour clock).

Date: To adjust the current time.

Date format: To select the display format for the date (**DD.MM.YYYY**, **YY-MM-DD** or **MM-DD-YY**).

Language: To select the desired language for the texts and announcements in the voice control system.

Additional keypad languages: To select the additional keypad languages.

Function button: function

Units: To set the measurement units for the vehicle displays.

Distance, vehicle speed, temperature, volume, consumption and pressure.

Mobile device data transfer

Data transfer for SEAT apps: Allows the exchange of information between the vehicle and SEAT applications. These are not personal data.

Operation via apps: Changes the level of interaction with the applications.

Deactivate: Limits specific functions that require a higher level of security.

Confirm: Allows 100% functionality of the App but with certain actions relating to the Infotainment system requiring confirmation.

Allow: Allows the execution of all the available functions from the App.

Voice control: To perform the voice control setup **»» page 13**.

Remove safely: To eject the data storage device (SD card 1/SD card 2/USB) from the system. After correctly ejecting the data storage device from the system, the function button becomes inactive (grey colour).

Factory settings: When resetting factory settings, all **entries and changes made are deleted**, depending on the selected setup.

Bluetooth: To perform Bluetooth® settings **»» page 87**.

WLAN[®]: To adjust the WLAN mobile hotspot settings **»» page 51**.

Function button: function

System information: Viewing system information (device number, hardware and software versions).

Update: To update navigation data » page 56 Do not remove the memory card while the navigation data is being installed.

Copyright: Copyright information.

Configuration wizard: Open the wizard to configure the initial setup of the Infotainment system.

a) Only available for the model: "Navi System Plus".

Note

For the proper functioning of the Infotainment system it is important that the date and time set in the vehicle are correct.

Sound and volume settings

Making settings

The selection of possible settings will depend on the country, the unit in question and the vehicle equipment.

- Press the infotainment **MENU** button » **Fig. 1** ① and then press the **Sound** context to open the **Sound settings** main menu.
- Press the function button on the main menu corresponding to one where changes

are to be made. All settings are applied instantaneously.

Overview of screen and function buttons

Function button: function

Volume: To adjust the volume settings.

Radio announcements: To set the playback volume of announcements, for example traffic announcements.

Navigation announcements: To adjust the playback volume of audible driving recommendations.

Voice control: To set the volume for voice control playback.

Maximum switch-on volume: To set the maximum switch-on volume of the equipment.

Speed-dependent volume adjustment (GALA): To determine the level of adjustment for speed-dependent volume. The audio volume will increase automatically as vehicle speed increases.

Entertainment fading while parking: To adjust the desired decrease in volume with ParkPilot activated.

Entertainment fading (nav. announcements): Adjusts the playback volume during a navigation announcement.

AUX volume: To set the playback volume of the audio sources connected via the AUX-IN multi-media socket (**Low**, **Medium** or **High**). Also see » page 91, Overview of screen and function buttons.

Function button: function

Bluetooth audio: To set the playback volume of the audio sources connected via Bluetooth® (**Low**, **Medium** or **High**). Also see » page 91, Overview of screen and function buttons.

Equaliser: To adjust the characteristics of the sound.

Balance - Fader: To adjust the distribution of the sound. The cursor indicates the current distribution of the sound inside the passenger compartment. To modify the distribution of the sound, briefly press the passenger compartment view for the desired position or use the arrow keys to change it gradually. To focus the distribution of sound in the centre of the passenger compartment, press the central function button located between the arrows.

Sound focus: Optimises the sound in the passenger compartment.

Subwoofer: To adjust the intensity of the subwoofer.

Touchscreen tone: Confirmation tone for pressing a function button is activated.

No voice guidance during call: No audible driving instructions will be given during a telephone conversation.

Adjust the playback volume for external audio sources

If you need to increase the playback volume for the external audio source, first lower the base volume on the Infotainment system.

If the sound from the external audio source is **too low**, increase the **output volume** on the »

external audio source. If this is not enough, change the **input volume** to **medium** or **high**.

If the sound from the connected external audio source is **too loud or distorted**, lower the **output volume** on the external audio source. If this is not sufficient, set the **input volume** to **Medium** or **Quiet**.

Other important information

Legal information

ECE

SEAT hereby declares that the unit is in compliance with the essential requirements and other relevant provisions of Directive 1999/5/EC (CE 0700).

Abbreviations

A2DP	Technology included by many manufacturers to transmit audio signals via Bluetooth (Advanced Audio Distribution Profile).
AM	Modulation of the wave amplitude (medium wave, MW)
AUX-IN	Additional audio input (Auxiliary Input)
AVRCP	Technology included by many manufacturers for the remote management of audio sources via Bluetooth (Audio Video Remote Control Profile).
DAB	Digital transmission standard for digital radio (Digital Audio Broadcasting)
DIN	Deutsches Institut für Normung (German industry standard).
DRM	Digital Rights Management
DTMF	Dial tone with dual tone multiple frequency

EON	Assistance for other radio transmission networks (Enhanced Other Network)
FM	Frequency modulation (ultra-short wave, UKW)
GPS	Global Positioning System.
GSM	Global System for Mobile Communications
HFP	Hands-Free Profile.
IMEI	Serial number for univocally identifying GSM devices (International Mobile Station Equipment Identity).
LED	Light Emitting Diode
MP3	Audio file compression format.
PIN	Personal identification number.
RDS	Radio data system.
SMS	Short Message Service.
SSD	Jukebox (SSD Solid-State-Drive).
TMC	Traffic reports for dynamic navigation (Traffic Message Channel)
TP	Traffic reports function in Radio mode (Traffic programme).
USB	Universal Serial Bus
VBR	Variable bit rate.
WLAN	Wireless Local Area Network
WMA	Audio file compression format.

Index

A

After starting route guidance	59
AM	29
Android Auto™	21
App	
SEAT Media Control	26
Apple CarPlay™	21
Areas where special regulations apply	78
AUX-IN	48
AUX-IN multimedia socket	48
external audio source	48
AUX-IN multimedia socket	48
Avoid congestion	65

B

Base volume	9
change	9
sound suppression (mute)	9
Bluetooth	
connect audio source	48
profiles	78
select Bluetooth audio	43
settings	87
Buttons	10

C

Call lists	86
Call mailbox	83
CAR	72
CAR menu	
management	72
CD/DVD	
select	42

CD and DVD	
mode	46
CD or DVD	
insert and eject	46
Check boxes	10
Communication between the Infotainment system and mobile devices	17
Connectivity	
Full Link	17
SEAT Media Control	26
WLAN hotspot	26
Connectivity Box	88
Controls	4
Copyright	37
information	91
Cursor	11

D

DAB	29
see: RADIO	31
Data transfer	17
Delayed switch off (waiting time)	9
Delete	
all entries	90
user entries	90
Delete data	90
Delete entries	90
Demo mode	
navigation	67
Destination memory	60
Dial number	83
Dial (telephone number)	83
Display	
use	10
DVD	52
control	52
DVD video mode	52

main menu	52
mode	46
regional code	52
settings	53
start	52
Dynamic route guidance	65

E

Eject	
see: CD or DVD	46
EON	34
Explosion risk areas	
telephone	78
External audio source	48
adjust the playback volume	91
Bluetooth audio	48
MEDIA-IN	47
WLAN audio	51
External data storage device	
MEDIA-IN	47
USB	47

F

Factory settings	90
Favourites (speed dial buttons)	
see PHONE	86
FM	29
Frequency wavelength	
AM	29
change	29
DAB	29
FM	29
Full Link	17
pairing	21
setup	21

Function buttons	10
main menu Images	54
MEDIA main menu	41
RADIO main menu	29

G

GALA	91
------------	----

H

Hard drive (Infotainment system)	
see Jukebox (SSD)	49
Hotspot	27

I

Ignition switched off	
delayed switch off (waiting time)	9
Images	
display	54
main menu	54
settings	54
Infotainment system buttons	9
Input mask	11
Interference from a mobile telephone	8
Introduction	7
iPad	47
iPhone	47
iPod	47

K

Keypad	11
--------------	----

L

Lowering the volume	8
---------------------------	---

M

Main menu

images	54
MEDIA	41
PHONE	81
RADIO	29
settings	90
sound	91

Map display

change	63
function buttons	64

MEDIA

AUX-IN multimedia socket	48
bit rate	37
Bluetooth audio	48
CD mode	46
CD with audio data	37
change media source	42
changing track	43
copyright	37
DVD mode	46
external data storage device connected to	
USB port	47
fast forward	43
faulty CD or DVD	46
function buttons	41
hard drive memory (jukebox SSD)	49
insert a memory card	46
insert and eject a CD or DVD	46
iPod, iPad and iPhone	47
main menu	41
MEDIA-IN	47
media mode	37
media source selection menu	42
memory card unreadable	46
messages and symbols	42
MP3 files	37

notes	41
playing order	40
playlists	39
play modes	41
prepare a memory card for removal	46
random play (Mix)	41
remove a memory card	46
repeat function (Repeat)	41
requirements	37
restrictions	39
rewind	43
scan (SCAN)	41
select data storage device	42
select track	44
settings	53
store audio files (jukebox SSD)	49
track information	42
track list	44
unreadable CD or DVD	46
WLAN audio	51
WMA files	37
Media playback sources	42
CD	42
SD card	42
select	42
USB	42
Media sources	
Bluetooth audio	43
Memory buttons	32
Memory card	
insert	46
prepare a memory card for removal	46
remove	46
select	42
unreadable	46
Messages	
navigation	56

- MirrorLink 22
 - Mobile Signal Amplifier 88
 - Mute 9
 - My destinations 60
- N**
- Navigation announcements 59
 - Navigation data 57
 - data update 56
 - install 57
 - NAV (navigation) 56
 - after starting route guidance 59
 - areas not fully digitalised 56
 - avoid congestion 65
 - change destination 60
 - change view 63
 - compass display 63
 - congestion ahead 60
 - contacts 60
 - data update 56
 - demo mode 67
 - destination memory 60
 - display traffic disruptions 64
 - dynamic route guidance 59, 65
 - entering destination 58
 - entering the home address 62
 - enter new destination 59
 - enter stopover 60
 - exclude section 60
 - fast search for a POI 62
 - function buttons 58
 - importing Personal POI 66
 - importing vCards 66
 - installing navigation data 57
 - list of driving manoeuvres 63
 - map display 64
 - map, select the destination on the map 59
 - messages and symbols 58
 - my destinations 60, 62
 - navigation announcements 59
 - navigation area 56
 - navigation main menu 58
 - navigation messages 56
 - opening the main menu 58
 - points of interest 62
 - possible limitations 56
 - road sign indicators 67
 - route information 60
 - route list 60
 - search 58
 - settings 67
 - split screen 63
 - stop route guidance 60
 - store position 61
 - TRAFFIC 64
 - traffic reports 64
 - updating navigation data 57
- O**
- On-screen keypad 11
 - Online traffic information 64
 - Operation
 - additional displays 12
 - changing the volume 9
 - function buttons 10
 - general instructions for use 8
 - Infotainment system buttons 9
 - input 11
 - input mask 11
 - on-screen keypad 11
 - PHONE 77, 80
 - RADIO 29
 - rotary knobs 9
 - search lists 11
 - slider 11
 - slide (screen) 11
 - sound suppression (mute) 9
 - switch on and switch off 9
 - touchscreen 10
 - voice control 13
- P**
- Personal POI
 - importing 66
 - PHONE
 - A2DP 78
 - areas where special regulations apply 78
 - bluetooth profiles 78
 - bluetooth settings 87
 - call lists 86
 - call mailbox 83
 - connect and disconnect the telephone management system 87
 - connection via the Infotainment system 79
 - contacts 84
 - description of the function 78
 - dial 83, 84
 - display and symbols 82
 - enter telephone number 83
 - explosion risk areas 78
 - favourites (speed dial buttons) 86
 - general information 77
 - GSM network 78
 - HFP 78
 - main menu 81
 - mobile telephone pairing 79
 - pairing of mobile telephone 79
 - pairing via the Infotainment system 79
 - phonebook 84
 - settings 87

- short messages (SMS) 85
 - telephone management system 77, 80
 - user profile settings 87
 - voice control 13
 - Physical buttons
 - see: Infotainment system buttons 9
 - Play
 - CD 46
 - DVD 46
 - external data storage device (USB) 47
 - MEDIA 41
 - RADIO 29
 - SD card 41
 - Playback
 - AUX-IN 48
 - Playing
 - track 44
 - POI
 - importing 66
 - Points of interest 62
 - Pop-up windows 10
 - Predictive navigation 65
- Q**
- Quick reference guide 7
- R**
- RADIO 29
 - additional DAB services 31
 - additional DAB stations 31
 - AM setup 35
 - change frequency 29
 - DAB display 31
 - DAB operation 31
 - DAB preset list 31
 - DAB Radio Text 31
 - DAB settings 36
 - DAB station information 31
 - DAB station tracking in FM 31
 - DAB transmission standards 31
 - EON 34
 - FM setup 35
 - information and icons 29
 - main menu 29
 - memory buttons 32
 - radio mode 29
 - radio text (RDS) 30
 - RDS 30
 - SCAN function 34
 - select stations 33
 - setting a station name 30
 - settings 35
 - station list 33
 - station names display 30
 - station tracking by RDS 30
 - store station logos 32
 - store stations 33
 - TP (traffic news) 34
 - traffic announcement (INFO) 34
 - traffic news (TP) 34
 - tune stations 33
 - tune the frequency of the stations 33
 - Radio text (RDS) 30
 - Random play (Mix) 41
 - RDS 30
 - automatic station tracking 30
 - regional RDS 30
 - TP (traffic news) 34
 - Repeat 41
 - Repeat function (Repeat) 41
 - Requirements for
 - data storage devices and files 37
 - Reset factory settings 90
 - Road sign indicators 67
 - Rotary knobs 9
 - Route guidance
 - demo mode 67
 - dynamic 65
- S**
- Safety Instructions
 - Infotainment system 7
 - SCAN
 - MEDIA 41
 - radio 34
 - SCAN function
 - RADIO 34
 - Scan (SCAN)
 - MEDIA 41
 - SD Card
 - see: memory card 46
 - Search 58
 - Search lists 11
 - SEAT Media Control
 - data transmission and control functions 26
 - Settings
 - bluetooth 87
 - DAB 36
 - default setting 90
 - factory settings 90
 - images 54
 - main menu 90
 - Media 53
 - menu and system settings 90
 - navigation 67
 - PHONE 87
 - radio 35
 - sound 91
 - system 90
 - user profile settings 87
 - video 53

Index

- voice control 16
- volume 91
- WLAN 51
- Setup
 - AM 35
 - FM 35
- Short messages (SMS) 85
- Show clock 90
- Slider 11
- Slide (screen) 11
- SMS 85
- Sound distribution (Balance and Fader) 91
- Sound settings (bass and treble) 91
- Sound suppression 9
- Sound suppression (mute) 9
- Special features
 - displays 12
 - lowering the volume 8
 - store station logos 32
- Speed-dependent volume 91
- Speed dial buttons
 - see PHONE 86
- Split screen
 - NAV (navigation) 63
- SSD (Media mode)
 - see Jukebox (SSD) 49
- Station
 - select 33
 - setting a station name 30
 - store 33
 - tune 33
- Station logos
 - store 32
 - store automatically 32
- Station names 30
- Stations
 - SCAN function 34
- Station search 34
- Station tracking 30
- Store
 - audio files (jukebox SSD) 49
 - Switch off 9
 - Switch on 9
- T**
 - Text entry 11
 - Things to note
 - AUX mode 48
 - TMCpro traffic reports 64
 - TMC traffic reports 64
 - TP (traffic news)
 - activate and deactivate 34
 - EON 34
 - TP (Traffic programme)
 - traffic announcement (INFO) 34
 - Track list 44
 - Traffic announcement (INFO) 34
 - Traffic news
 - see: TP (traffic news) 34
 - Traffic reports 64
 - online 64
 - on the map 64
 - symbols 64
 - TMC/TMCpro 64
 - Traffic sign recognition 67
- U**
 - Unit buttons 9
 - Unit buttons overview 4
 - Unit overview 4
 - USB
 - connect an external data storage device 47
 - disconnect 47
 - error messages 47
- faults 47
- select 42
- unreadable 47
- USB port 
 - iPad management 47
 - iPhone management 47
- USB port 
 - iPod management 47
- Use
 - check boxes 10
- User profile
 - settings 87
- V**
 - vCards
 - importing 66
 - video
 - settings 53
 - View
 - NAV (navigation) 63
 - Virtual buttons
 - see: Function buttons 10
 - Voice control 13
 - languages available 13
 - Volume
 - announcements 91
 - base volume 9
 - change 9
 - set for external audio sources 91
 - speed-dependent volume adjustment (GALA) 91
 - Volume distribution (Balance and Fader) 91
- W**
 - Waiting time 9
 - Wireless Charger 88

WLAN	26
connect external audio source	51
settings	51
WLAN hotspot	26
configure hotspot	27
establishing wireless network connection	27

SEAT S.A. is permanently concerned about continuous development of its types and models. For this reason we ask you to understand, that at any given time, changes regarding shape, equipment and technique may take place on the car delivered. For this reason no right at all may derive based on the data, drawings and descriptions in this current handbook.

All texts, illustrations and standards in this handbook are based on the status of information at the time of printing. Except for error or omission, the information included in the current handbook is valid as of the date of closing print.

Re-printing, copying or translating, whether total or partial is not allowed unless SEAT allows it in written form.

SEAT reserves all rights in accordance with the "Copyright" Act.

All rights on changes are reserved.

 This paper has been manufactured using bleached non-chlorine cellulose.

© SEAT S.A. - Reprint: 15.11.17

Inglés 5F0012720DH (11.17)



5F0012720DH

