



OWNER'S MANUAL

Alhambra



About this manual

This manual contains a description of the **equipment** supplied with the vehicle at the time this manual was published. Some of the units described herein will not be available until a later date or are only available in certain markets.

Because this is a general manual for the ALHAMBRA, some of the equipment and functions that are described in this manual are not included in all types or variants of the model; they may vary or be modified depending on the technical requirements and on the market; this is in no way deceptive advertising.

The **illustrations** are intended as a general guide and may vary from the equipment fitted in your vehicle in some details.

The **steering indications** (left, right, forward, reverse) appearing in this manual refer to the normal driving movements of the vehicle except when otherwise indicated.

The **audiovisual material** only is intended to help users to understand certain car functionalities better. It does not replace the instruction manual. Please use the instruction manual to obtain more comprehensive information and indications.

✱ The **equipment marked with an asterisk*** is fitted as standard only in certain versions, and is only supplied as optional extras for some versions, or are only offered in certain countries.

® All **registered marks** are indicated with ®. Although the copyright symbol does not appear, it is a copyrighted mark.

» The section is continued on the following page.



Important warnings on a given page



Detailed contents on a given page



General information on a given page

SOS

Emergency information on a given page



WARNING

Texts preceded by this symbol contain information on safety. They warn you about possible dangers of accident or injury.



CAUTION

Texts with this symbol draw your attention to potential sources of damage to your vehicle.



For the sake of the environment

Texts preceded by this symbol contain relevant information concerning environmental protection.



Note

Texts preceded by this symbol contain additional information.

This manual is divided into six large parts, which are:

1. The essentials
2. Safety
3. Emergencies
4. Operation
5. Tips
6. Technical data

At the end of this manual, there is a detailed alphabetical index that will help you quickly find the information you require.

Foreword

This Instruction Manual and its corresponding supplements should be read carefully to familiarise yourself with your vehicle.

Besides the regular care and maintenance of the vehicle, its correct handling will help preserve its value.

For safety reasons, always note the information concerning accessories, modifications and part replacements.

If selling the vehicle, give all of the on-board documentation to the new owner, as it should be kept with the vehicle.

You can access the information in this manual using:

- Thematic table of contents that follows the manual's general chapter structure.
- Visual table of contents that uses graphics to indicate the pages containing "essential" information, which is detailed in the corresponding chapters.
- Alphabetical index with many terms and synonyms to help you find information.

WARNING

Read and always observe safety information concerning the passenger's front airbag »» page 76, Important information regarding the front passenger's airbag.

Thank you for trusting in us.

We wish you safe and enjoyable motoring.

SEAT, S.A.

Related videos



Park Assist

www.seat.com/youtube-af/althambra/parkingsystem

»» page 214



Blind Spot Detector (BSD)

www.seat.com/youtube-af/althambra/blindspot

»» page 225

Frequently Asked Questions

Before driving

How do you adjust the seat? » page 15

How do you adjust the steering wheel? » page 18

How do you adjust the exterior mirrors? » page 18

How do you turn on the exterior lights? » page 25

How does the automatic gearbox selector lever work? » page 36

How do you refuel? » page 40

How do you activate the windscreen wipers and windscreen washer system? » page 27

Emergency situations

A warning lamp lights up or flashes. What does this mean? » page 34

Where are the first-aid kit and the warning triangle in the vehicle? » page 83

How do you open the bonnet? » page 13

How do you perform a jump start? » page 52

Where is the vehicle tool kit located? » page 46

How do you repair a tyre with the anti-puncture kit? » page 45

How do you change a wheel? » page 46

How do you change a fuse? » page 43

How do you change a light? » page 92

How do you tow a vehicle? » page 51

Useful tips

How do you set the time? » page 103

When should the vehicle inspection should be performed? » page 105

What functions do the buttons/thumbwheels on the steering wheel perform? » page 108

How do you remove the luggage compartment cover? » page 170

How do you drive in an economical and environmentally-friendly way? » page 200

How do you check and top up the engine oil? » page 40

How do you check and top up the engine coolant? » page 41

How do you top up the windscreen washer fluid? » page 42

How do you check and top up the brake fluid? » page 42

How do you check and adjust tyre pressure values? » page 291

Vehicle washing tips » page 253

Functions of interest

How does the START-STOP system work? » page 209

What parking assistants are available? » page 211, » page 214

How does the rear assist work? » page 217

How does the lane departure warning system work? » page 222

How does tyre pressure monitoring work? » page 234

How do you open the vehicle without a key (Keyless Access)? » page 117

Interior lighting and ambient light » page 136

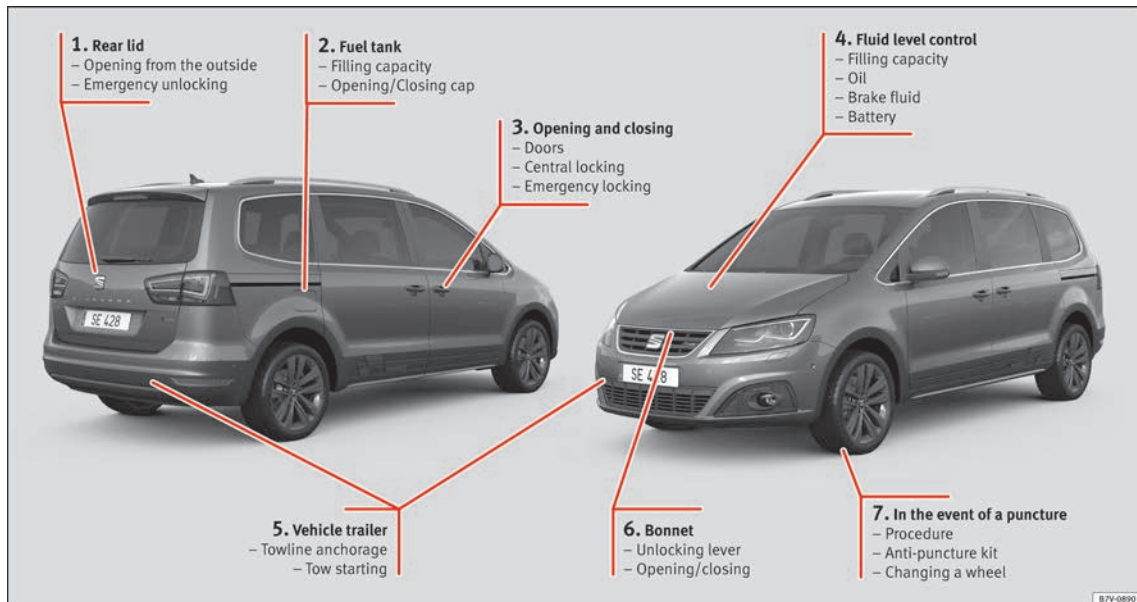
Table of Contents

The essentials	7	Seat belts	62	Doors	121
Exterior view	7	Why wear a seat belt	62	Sliding doors	122
Exterior view	8	How to properly adjust your seatbelt	65	Rear lid	124
Interior view (left-hand drive)	9	Seat belt tensioners	68	Controls for the windows	127
How it works	10	Airbag system	69	Panoramic sliding sunroof*	129
Unlocking and locking	10	Brief introduction	69	Lights and visibility	130
Before driving	15	Airbag safety instructions	72	Lights	130
Airbags	19	Deactivating airbags	73	Visibility	136
Child seats	22	Transporting children safely	75	Windscreen wiper and window wiper systems	137
Starting the vehicle	25	Safety for children	75	Rear vision mirror	140
Lights and visibility	25	Child seats	76	Seats and head restraints	143
SEAT information system	27	Integrated child seat	79	Adjusting the seats and headrests	143
Cruise control	33	Emergencies	83	Seat functions	147
Warning lamps	34	Self-help	83	Transport and practical equipment	152
Gearbox lever	35	In case of emergency	83	Transporting objects	152
Air conditioning	37	Vehicle tool kit*	83	Luggage compartment	154
Fluid Level control	40	Changing a wheel*	85	Roof carrier*	164
Emergencies	43	Tyre repair	86	Storage compartments	166
Fuses	43	Changing the windscreen wiper blades	88	Drink holders	171
Bulbs	44	Tow-starting and towing	88	Ashtray and cigarette lighter*	172
Action in the event of a puncture	45	Emergency locking and unlocking	90	Power sockets	173
Changing a wheel	46	Fuses and bulbs	91	Air conditioning	176
Snow chains	50	Fuses	91	Air conditioning	176
Emergency towing of the vehicle	51	Changing bulbs	92	Auxiliary heater* (additional heater)	180
How to jump start	52	Operation	101	Driving	183
Changing windscreen wipers	55	General instrument panel	101	Stopping and starting the engine	183
Safety	57	Instrument panel	100	Braking and parking	188
Safe driving	57	Instruments	102	Gearbox	193
Safety first!	57	Control lamps	107	Address	198
Advice about driving	57	Communications and multimedia	108	Run-in and economical driving	199
Correct position of the vehicle occupants	58	Steering wheel controls*	108	Engine management and exhaust gas purification system	202
Pedal area	61	Multimedia	110	Driving tips	204
		Three button unit in headliner	110	Driver assistance systems	205
		Opening and closing	112	Braking and stability systems	205
		Vehicle key set	112	Start assist systems	208
		Central locking and locking system	114	Parking distance warning system*	211

Table of Contents

Park Assist system* (Park Assist)	214	Technical data	297
Rear assist* (Rear View Camera)	217	Technical features	297
Cruise control* (Cruise control system - CCS)	221	Important information	297
Lane Assist system*	222	Towing a trailer	298
Blind spot detector (BSD) with rear cross traffic alert (RCTA)	225	Wheels	299
Traffic signal detection (Sign Assist)*	230	Engine data	300
Tiredness detection (recommendation to take a break)	232	Dimensions	305
Dynamic Chassis control (DCC)*	233	Index	307
Tyre monitoring systems	234		
Towing bracket device	237		
Driving with a trailer	237		
Advice	247		
Care and maintenance	247		
Accessories, replacement of parts and modifi- cations	247		
Caring for and cleaning the vehicle exterior ...	253		
Caring for and cleaning the vehicle interior ...	259		
Notes for the user	263		
Checking and refilling levels	264		
Filling the tank	264		
Fuel	267		
Selective catalytic reduction* (AdBlue)	268		
Working in the engine compartment	271		
Engine oil	274		
Engine coolant	277		
Brake fluid	281		
Windscreen washer reservoir	283		
Vehicle battery	283		
Wheels and tyres	287		
Tyres	287		
Winter service	295		

Exterior view



① » page 12

② » page 40

③ » page 10

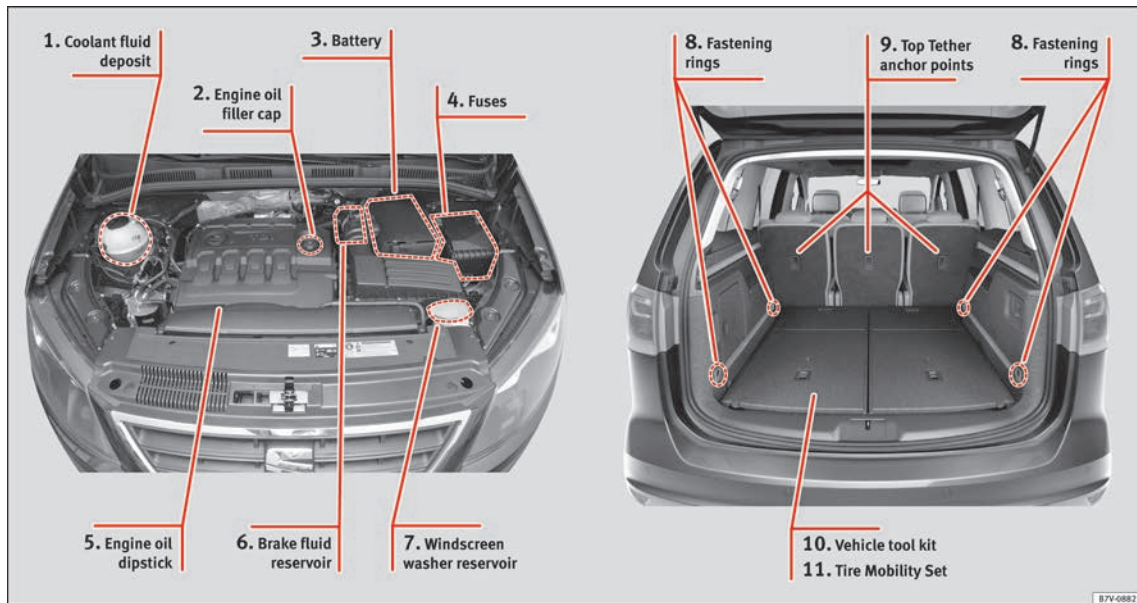
④ » page 40

⑤ » page 51

⑥ » page 13

⑦ » page 45

Exterior view



① »» page 41

② »» page 40

③ »» page 42

④ »» page 43

⑤ »» page 40

⑥ »» page 42

⑦ »» page 42

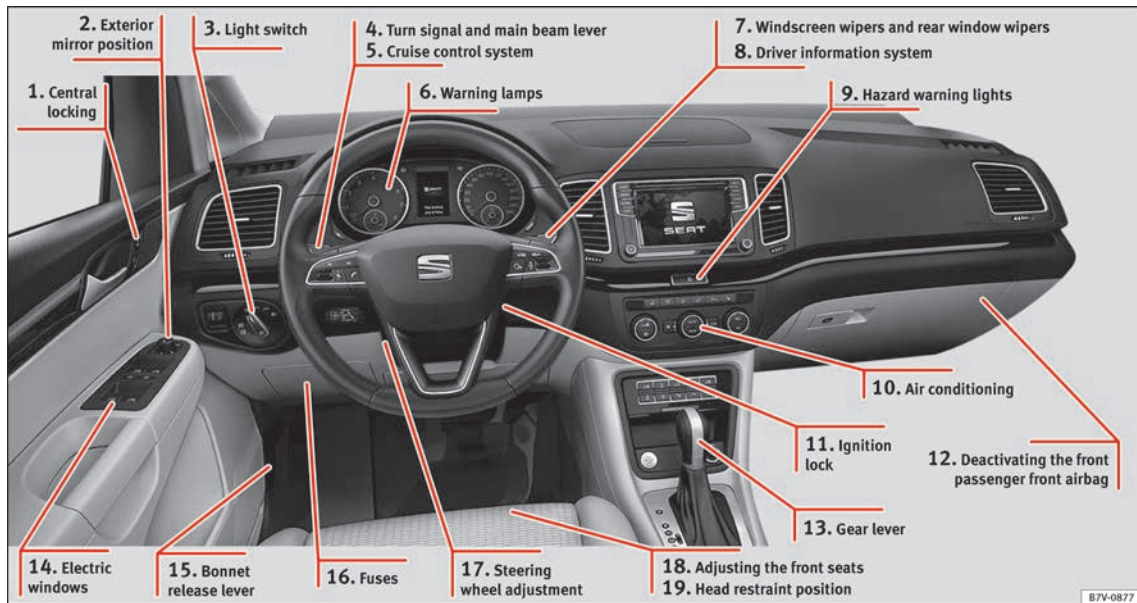
⑧ »»  page 160

⑨ »» page 24

⑩ »» page 46

⑪ »» page 45

Interior view (left-hand drive)



- ① » page 10
- ② » page 18
- ③ » page 25
- ④ » page 26

- ⑤ » page 33
- ⑥ » page 34
- ⑦ » page 27
- ⑧ » page 27

- ⑨ » page 26
- ⑩ » page 37
- ⑪ » page 25
- ⑫ » page 20

- ⑬ » page 35
- ⑭ » page 13
- ⑮ » page 13
- ⑯ » page 43

- ⑰ » page 18
- ⑱ » page 15
- ⑲ » page 17

How it works

Unlocking and locking

Doors



Fig. 1 Remote control key: buttons.

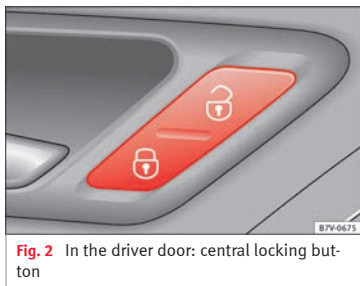








Fig. 2 In the driver door: central locking button

Locking and unlocking the vehicle using the key

- Locking: press the  **Fig. 1** button.
- Locking the vehicle without activating the anti-theft system: press the  **Fig. 1** button for a second time within 2 seconds.
- Unlocking: press the  **Fig. 1** button.
- Unlocking the rear lid: hold down the  **Fig. 1** button for at least 1 second.

Locking and unlocking with the central locking switch

- Locking: press the  **Fig. 2** button. None of the doors can be opened from the outside. The doors can be opened from the inside by pulling the inside door handle.
- Unlocking: press the  **Fig. 2** button.



»  in Introduction on page 114



» page 112

SOS

» page 10, » page 11

Locking or unlocking of driver door

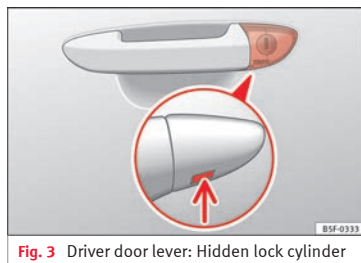





Fig. 3 Driver door lever: Hidden lock cylinder

As a general rule, when the driver door is locked all other doors are locked. Unlocking manually only opens the driver door. Please note the instructions for the anti-theft alarm **»  page 114.**

- Unfold the key shaft **»  page 112.**
- Insert the key shaft into the lower opening in the cover on the driver door handle

- » **Fig. 3** (arrow) then remove the cover upwards.
- Insert the key blade into the lock cylinder to unlock or lock the vehicle.


Special Characteristics

- The anti-theft alarm will remain active when vehicles are unlocked. However, it is not triggered »  page 114.
- If the driver door is opened, the alarm will be triggered.
- Switch the ignition on. The electronic immobilizer recognises a valid vehicle key and deactivates the anti-theft alarm system.



»  in Introduction on page 91

Note

The anti-theft alarm is not activated when the vehicle is locked manually using the key shaft »  page 114.

Locking the passenger side door and sliding doors manually





Fig. 4 At the front of the passenger sliding door: Emergency lock, hidden by a rubber cap.



Fig. 5 Emergency locking of the vehicle using the vehicle key


The passenger side door and the sliding doors can be locked manually. The anti-theft alarm is **not** activated in this case.

- Open the door.
- Remove the rubber cap to the front of the door. The rubber cap is marked with a lock symbol  » **Fig. 4**.
- Unfold the vehicle key blade »  page 112.
- Insert the key shaft horizontally into the opening and moved the coloured lever forward » **Fig. 5**.
- Replace the rubber cap and close the door.
- Check if the door is locked.
- Carry out the same operation on the other doors if necessary.
- Have the vehicle checked by a specialised workshop.



»  in Introduction on page 91

Note

The doors can be opened and unlocked individually from the inside by pulling the door handle. To open, pull the inner door release lever twice »  page 114.

Opening the rear lid

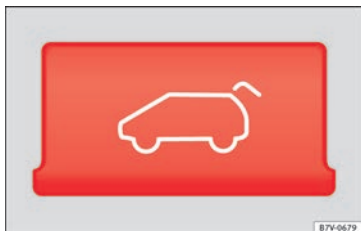


Fig. 6 Detailed view of the centre console button for unlocking the rear lid

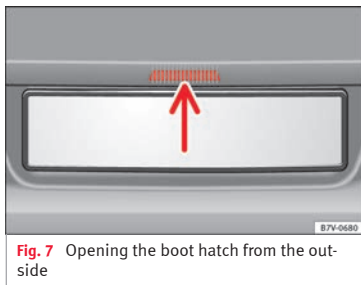




Fig. 7 Opening the boot hatch from the outside

Before opening the rear lid, always remove any load on its luggage rack » » ⚠ in Introduction on page 124.

Opening with the ignition key

- Press the  button on the vehicle key until the rear lid opens automatically.

To open using the centre console control

- Press the  button on the centre console » » **Fig. 6**. The rear lid will be automatically opened.
- The button is still operative when the ignition is switched off.

Opening the rear lid with the button

- Unlock the vehicle or open a door.
- Raise the rear lid using the button » » **Fig. 7** (arrow).



» » ⚠ in Introduction on page 124

Manual release mechanism for the rear lid



Fig. 8 From the luggage compartment: remove the boot hatch cover.



Fig. 9 From the luggage compartment: Emergency unlocking of the boot hatch.

- Remove equipment to access the inside of the rear lid.
- Remove the square cover in the inner trim of the rear lid » » **Fig. 8**.

- Push the release lever »» Fig. 9 A in the direction of the arrow to unlock the boot.
- Manually open the rear lid.



»» ⚠ in Introduction on page 91

Bonnet

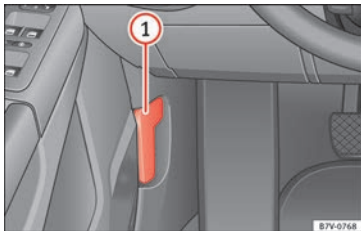


Fig. 10 Release lever in the driver's footwell area.



Fig. 11 Cam under the bonnet

- Opening the bonnet: Pull the lever under the dashboard »» Fig. 10 ①.
- Lift up the bonnet. Press the release catch under the bonnet upwards »» Fig. 11. The ar-
rester hook under the bonnet is released.
- The bonnet can be opened. Release the bonnet stay and secure it in the fixture designed for this in the bonnet.



»» ⚠ in Opening and closing the bonnet on page 273



»» page 271

Controls for the windows*

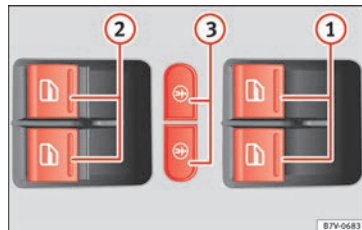


Fig. 12 Detail of the driver door: controls for the windows, and the electric child safety lock buttons.


Buttons on the driver door

- ① For the front electric windows.
- ② For the sliding door electric windows.
- ③ To lock the sliding doors and their windows.

Opening and closing the windows

Opening:	Push the button.
Closing:	Pull the button.
To stop the window function:	Press or pull on the corresponding window button. »»



Press the  button for the electronic child safety lock to deactivate the controls for the electric windows on the sliding doors and to lock these doors
 » page 122. The indicator on the button will light up.



»  in Controls for the windows: functions on page 128



» page 127

Panoramic sunroof*

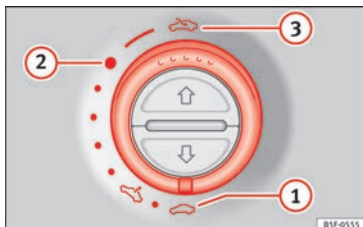


Fig. 13 On the interior roof lining: use the rotary button for opening and closing

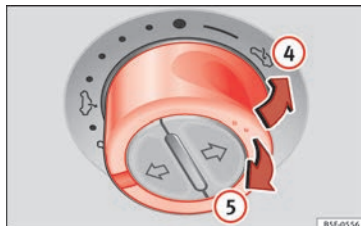








Fig. 14 On the interior roof lining: press the button and pull on it to raise and lower the sunroof.

To open the panoramic sliding sunroof, the switch must be in the position .

- Opening: Turn the switch to position
 » **Fig. 13** .
- Convenience position: Turn the switch to position
 » **Fig. 13** .
- Closing: Turn the switch to position
 » **Fig. 13** .
- To tilt open: Push the switch to position
 » **Fig. 14** . For an intermediate position, hold down the switch until you reach the desired position.
- Lowering: Pull the switch to position
 » **Fig. 14** . For an intermediate position, hold down the switch until you reach the desired position.



»  in Panoramic sliding sunroof: operating on page 129



» page 129

SOS

» page 15

Manually closing the panoramic sunroof

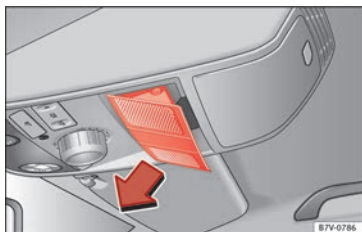


Fig. 15 On the interior roof lining: remove cover.

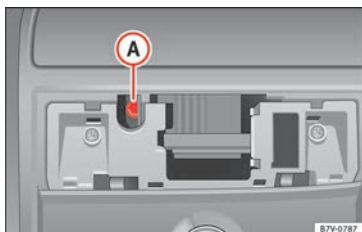


Fig. 16 Allen bolt to close the panoramic sliding sunroof

- Push open the cover in the direction indicated (arrow) » **Fig. 15**.

- Insert a standard 4 mm Allen key¹⁾ into the Allen bolt » **Fig. 16 A**.
- Rotate the Allen bolt to close the panoramic sliding sunroof.
- Re-install the lining.
- Bring the vehicle to a specialised workshop to check the panoramic sliding sunroof given that the emergency closing operation could damage general operation or the anti-trap function of the panoramic sliding sunroof.



» ⚠ in Introduction on page 91

Before driving

Manually adjusting the front seat

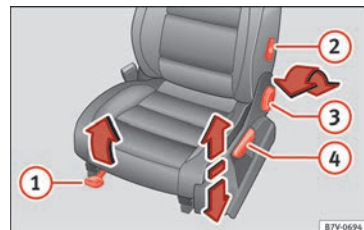


Fig. 17 Front left seat controls

The controls are mirrored for the front right-hand seat.

Mechanically and electrically adjusted controls can be combined on the seat.

- ① Move the seat backwards or forwards: pull the lever and move the seat forwards or backwards. The seat must engage when the lever is released!
- ② Adjusting the lumbar support*: turn the lever.
- ③ Adjusting the seat backrest angle: turn the wheel.

»

¹⁾ Not included with the vehicle tool kit.

- 4 Adjusting the seat height: pull the lever up or push down (several times if necessary) from its home position.



» ⚠ in Manual adjustment of the seats on page 143

Electrical controls on the front seat*

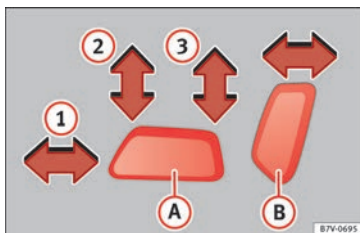


Fig. 18 Adjusting the front left seat forwards or backwards, the height, the seat angle and the front seat backrest

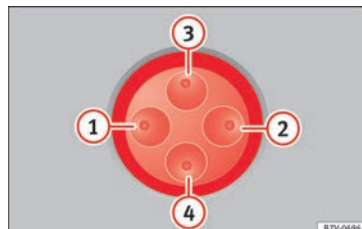


Fig. 19 Adjusting the lumbar support

The controls are mirrored for the front right-hand seat.

Mechanically and electrically adjusted controls can be combined on the seat.

Fig. 18 Press the control in the direction of the arrow:

	1	Move the seat backwards or forwards.
A	2 and 3	Raise or lower the seat.
	2 or 3	Adjust the seat angle.
B	Forwards or backwards.	Adjust the seat backrest angle.

Fig. 19 Press the corresponding area of the switch:

1 or 2	Adjust the curve of the lumbar support.
3 or 4	Adjust the height of the lumbar support.



» ⚠ in Electric driver's seat adjustment* on page 143

Adjustment of the head restraint

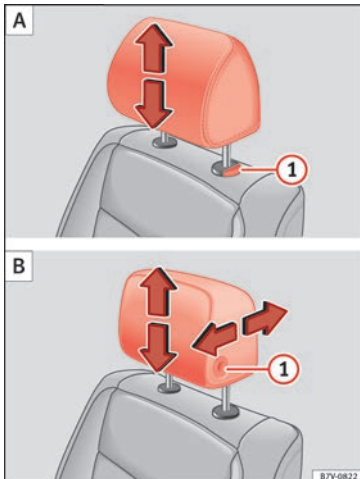


Fig. 20 Front seat: adjustment of the head restraint.

Grab the sides of the head restraints with both hands and push upwards to the desired position. To lower it, repeat the same action, pressing the ① button on the side.



» ⚠ in Removing and installing the head restraints on page 146



» page 58, » page 144

Adjustment of the seat belt

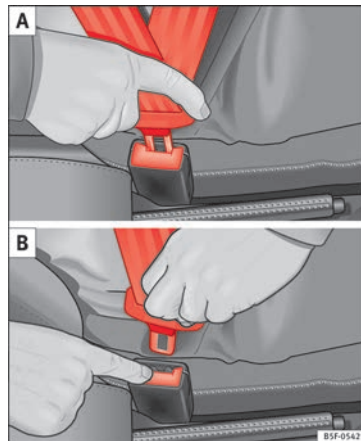


Fig. 21 Positioning and removing the seat belt buckle.

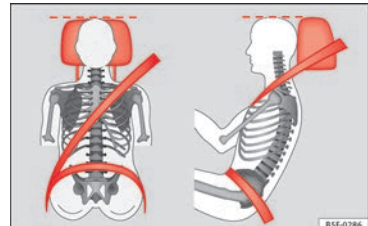


Fig. 22 Correct seat belt and head restraint positions, viewed from front and the side.

To adjust the seat belt around your shoulders, adjust the height of the seats or the height of the belt.

The shoulder part of the seat belt should be well centred over it, never over the neck. The seat belt lies flat and fits comfortably on the upper part of the body.

The lap part of the seat belt lies across the pelvis, never across the stomach. The seat belt lies flat and fits comfortably on the pelvis.



» page 62



» page 65

Seat belt tensioners

In the event of a head-on, lateral or rear collision, the seat belts on the front seats and the outer seats of the second row will tighten automatically.

The tensioner can be triggered only once.



» » ⚠ in Service and disposal of belt tension devices on page 69



» » page 68

Adjusting the exterior mirrors

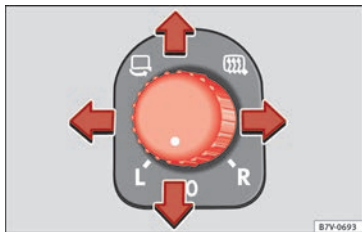


Fig. 23 In the driver door: exterior mirror controls

Adjusting the exterior mirrors: Turn the knob to the corresponding position:

L/R Turning the knob to the desired position, adjust the mirrors on the driver side (L, left) and the passenger side (R, right) to the direction desired.



Depending on the equipment fitted on the vehicle, the mirrors may be heated according to the outside temperature.



Folding in mirrors.



» » ⚠ in Exterior mirrors on page 142



» » page 141

Adjusting the steering wheel

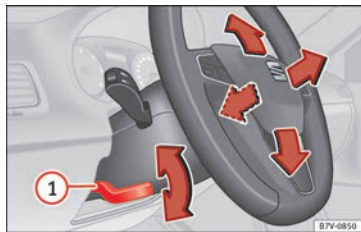


Fig. 24 Mechanical steering wheel adjustment

Adjust the steering wheel before your trip and only when the vehicle is stationary.

- Push the lever » » **Fig. 24** ① downwards.
- Adjust the steering wheel so that you can hold onto the steering wheel with both hands on the outside of the ring at the 9 o'clock and 3 o'clock positions and your arms slightly bent.
- Push the lever firmly upwards until it is flush to the steering column » » ⚠ in **Adjusting the steering wheel position** on page 59.



» » ⚠ in **Adjusting the steering wheel position** on page 59

Airbags

Front Airbags

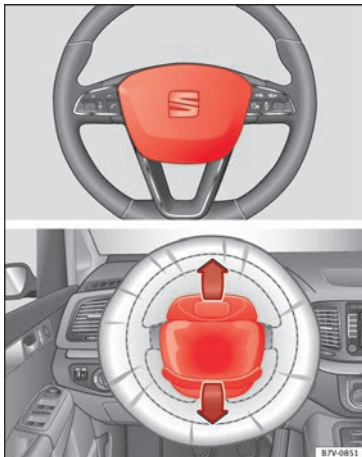


Fig. 25 Location and deployment area of the front airbag for the driver



Fig. 26 Location and deployment area of the front airbag for the front passenger

In conjunction with the seat belts, the front airbag system gives the driver and the front passenger additional protection for the head and chest in the event of a severe frontal collision. Always remains as far away as possible from the front airbag. This way, in the event of an accident, the front airbags can

deploy fully when triggered, providing maximum protection.

The front airbag for the driver is located in the steering wheel » **Fig. 25** and the airbag for the front passenger is located in the dash panel » **Fig. 26**. Airbags are identified by the word “AIRBAG”.

When the front airbags are triggered they fill the zones marked in red (deployment area) » **Fig. 25**. Therefore, objects should never be placed or mounted in these areas » **Δ** in **Front airbags on page 72**, Factory-fitted accessories are outside the range of the front airbag for the driver and the front passenger, e.g. the baseplate for the mobile phone support.

The airbag covers open out of the steering wheel or dash panel and remain attached to them when the driver and front passenger front airbags are triggered » **Fig. 26**.



» **Δ** in **Front airbags on page 72**

Disconnecting the passenger front air-bag



Fig. 27 In the glove compartment on the front passenger side: Key switch for enabling and disabling the front passenger front airbag.

Disabling the front passenger front airbag

- Switch the ignition off.
 - Open the glove compartment on the front passenger side.
 - Unfold the vehicle key blade
- » page 112.
- Insert the key into the slot of the switch for deactivating the front passenger airbag
- » **Fig. 27**. About 3/4 of the key should enter, as far as it will go.
- Then turn the key gently to the **OFF** position. Do not force it if you feel resistance, and make sure you have inserted the key fully.
 - Close the glove compartment on the front passenger side.

- The **PASSENGER AIR BAG OFF** control lamp on the dash panel will remain lit while the ignition is switched on » page 73.



» in Manual disabling and enabling of the front passenger front airbag with the key switch on page 74



» page 74

Knee airbag

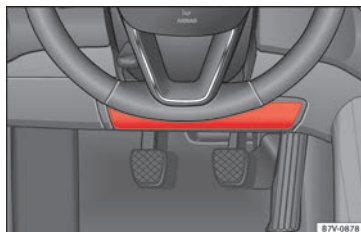


Fig. 28 On the driver side: location of the knee airbag

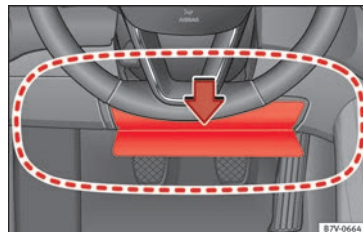


Fig. 29 On the driver side: radius of action of the knee airbag.

The knee airbag is located on the driver side below the dash panel » **Fig. 28**. Airbags are identified by the word “AIRBAG”.

The area framed red » **Fig. 29** is covered by the knee airbag when it is triggered (deployment area). Therefore, objects should never be placed or mounted in these areas.



» in Knee airbag* on page 72

Side airbags

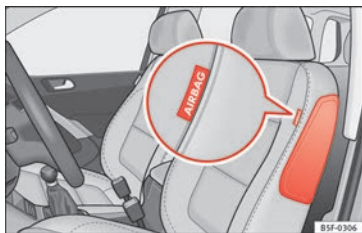


Fig. 30 On the side of the front seat: location of the side airbag



Fig. 31 Range of action of the front and rear side airbags. With 5 and 7 seats.

The side airbags are located in the outer cushion of the driver and front passenger

seat backrests » **Fig. 30**. Depending on the equipment of the model, the outer seats of the second row of seats may also be fitted with side airbags, located between the seat backrests and the access area. Their position is indicated by the word "AIRBAG". The red area (dotted line) » **Fig. 31** shows the field of action of the side airbags.

In a side collision, the side airbags are triggered on the affected side of the vehicle, thus reducing the risk of injury to passengers on that side.



» ⚠ in Side airbags* on page 72

Head-protection airbags

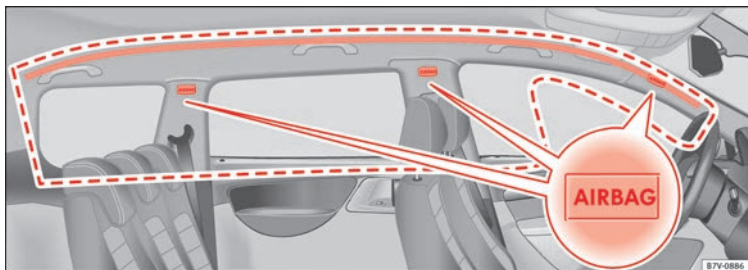


Fig. 32 On the left side of the vehicle: location and deployment area of the curtain airbag

»



Fig. 33 Deployed head-protection airbags.

The curtain airbags are located on the driver and front passenger side above the doors » Fig. 32. Airbags are identified by the word "AIRBAG".

The area framed red » Fig. 32 is covered by the curtain airbag when it is deployed (deployment area). Therefore, objects should never be placed or mounted in these areas.

In a side collision, the curtain airbag on the side affected will be deployed. The airbag covers the windows and pillars.

In a side collision, the head-protection airbags for the front and outer rear seats reduce the risk of injury to the areas of the body facing the impact.



» ⚠ in Curtain airbags* on page 73

Child seats

Important information regarding the front passenger's airbag



Fig. 34 Airbag stickers - version 1: on the passenger-side sun blind [A] and on the rear frame of the front passenger's door [B].



Fig. 35 Airbag stickers - version 2: on the passenger-side sun blind [A] and on the rear frame of the front passenger's door [B].

A sticker with important information about the passenger airbag is located on the passenger's sun visor and/or on the passenger side door frame.



» ⚠ in Introduction on page 75



» page 76

Different mounting systems

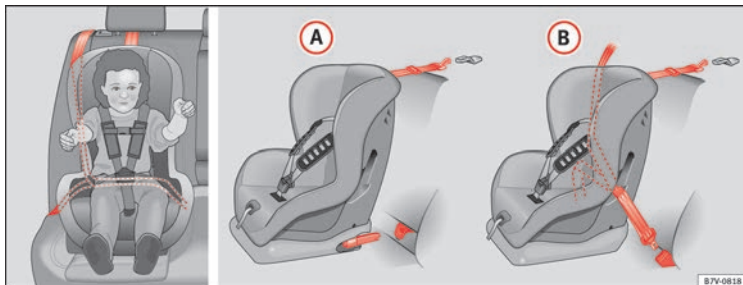


Fig. 36 On the rear seats: Possible installations for the child seat.

Always secure child seats properly and safely in the vehicle according to the child seat manufacturer's installation instructions.

Mounted child seats must rest correctly on the vehicle's seat and must not move or rock more than 2.5 cm (1 inch).

Child seats equipped for a Top Tether strap must also be secured using the Top Tether retaining strap in the vehicle » page 24. Only secure the retaining belt to the rings fitted for this purpose and identified as Top Tether. Not all rings can be used with the Top Tether system. Always tighten the Top Tether retaining strap so that the child seat fits snugly against the corresponding seat in the vehicle.

Specific mounting systems for each country

- (A)** Europe: ISOFIX retaining rings and upper retaining strap » page 24 and » page 24.
- (B)** Three-point seat belt and upper retaining strap » page 23.

The systems include the child restraint system mounting with an upper retaining strap (Top Tether) and lower anchoring points on the seat.

Securing child seats with the seat belt

Securing the child seat using the seat belt

- Please read and observe the child seat manufacturer's handling instructions.

- Positioning the child seat on the seat according to the manufacturer's instructions.
- The seat belt height adjustment must be as high as possible.
- Fasten the seat belt or pass it around the child seat structure in the manner described in the manufacturer's instructions.
- Make sure the seat belt is not twisted.
- Insert the latch plate into the buckle for the appropriate seat and push it down until it is securely locked with an audible click.
- Ensure that the upper belt web lies tightly on the child seat.
- Pull the belt (it must be no longer possible to pull the lower belt webbing out).



Removing the child seat

The seat belt must not be unfastened until the vehicle has come to a standstill.

- Press the red button on the buckle. The latch plate is released from the buckle.
- Guide the belt back by hand so that it rolls up easily and the trim will not be damaged.
- Remove the child seat from the vehicle.



» » ⚠ in Safety instructions on page 76

Fix the child seat with the lower anchor points (ISOFIX) ISOFIX system

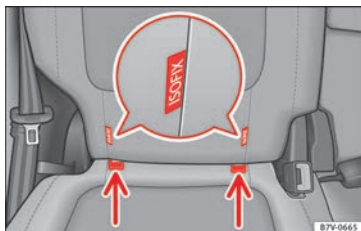


Fig. 37 Version 2: identification of the anchor points for the child seat on the vehicle seat

There are **two** retaining rings, the so-called lower anchor points, on each rear seat or, where applicable, on the front passenger

seat. The retaining rings are attached to the seat frames.

Child seats with rigid mounting

- Observe the manufacturer's instructions when installing and removing the child seat.
- Press the child seat onto the retaining rings » » **Fig. 37** in the direction of the arrow. The child seat must be safely engaged and click audibly into place.
- Pull on both sides of the child seat to ensure that it is secure.

Child seat with adjustable retaining straps

- Observe the manufacturer's instructions when installing and removing the child seat.
- Place the child seat on the seat cushion and attach the retaining strap hooks to the retaining rings » » **Fig. 37**.
- Tighten the straps evenly using the corresponding adjustment device. The child seat must sit flush against the vehicle seat.
- Pull on both sides of the child seat to ensure that it is secure.



» » ⚠ in Safety instructions on page 76

Securing a child seat using a Top Tether retaining strap

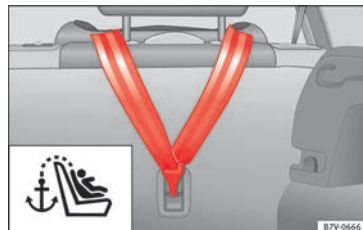


Fig. 38 Upper retaining strap hooked in the luggage compartment

- Observe the manufacturer's instructions when installing and removing the child seat » » ⚠ in Safety instructions on page 76.
- Raise the head restraint behind the child seat until it engages.
- Secure the child seat to the lower anchor points » » page 24.
- Pull the upper child seat retaining strap back to the seat backrest of the rear seat, **below** or on **both sides** of the head restraint (depending on the child seat model).
- Hook the upper retaining strap to the corresponding retaining ring (for Top Tether) on the back of the seat backrest on the rear seat » » **Fig. 38**.

- Push the head restraint down as far as it will go. Ensure that it does not interfere with the seatbelt from the upper attachment.
- Tighten the strap so that the top of the child seat rests on the seat backrest.



» » ⚠ in Safety instructions on page 76

Starting the vehicle

Ignition lock

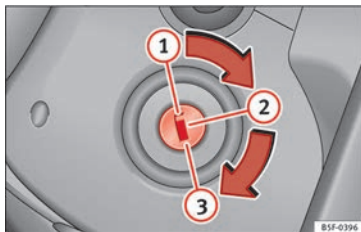


Fig. 39 Vehicle key positions

Switch ignition on: Place the key in the ignition and start the engine.

Locking and unlocking the steering wheel

- Engaging the steering wheel lock: Remove the key from the ignition and turn the wheel

until it locks. In vehicles with an automatic gearbox, the gear lever must be in the **P** position in order to remove the key. If necessary, press the locking key on the selector lever and release it again.

- Unlocking the steering wheel: Put the key into the ignition and turn it at the same time as the steering wheel in the direction indicated by the arrow. If it is not possible to turn the steering wheel, it may be because it is locked.

Turning on/switching off the ignition, glow plugs reheating

- Switch ignition on: Turn the key to the ② position.
- Switch ignition off. Turn the key to the ① position.
- Diesel vehicles ⚙: The glow plugs reheat when the ignition is switched on.

Starting the engine

- Manual gearbox: press the clutch pedal all the way down and move the gearbox lever into neutral.
- Automatic gearbox: Press the brake pedal and move the selector lever to the **P** position or into **N**.
- Turn the key to the ③ position. The key automatically returns to the ② position. Do not press the accelerator.

Start-Stop System*

When you stop and release the clutch pedal, the Start-Stop system* turns off the engine. The ignition remains switched on.



» » ⚠ in Ignition lock on page 184



» » page 184

Lights and visibility

Light switch

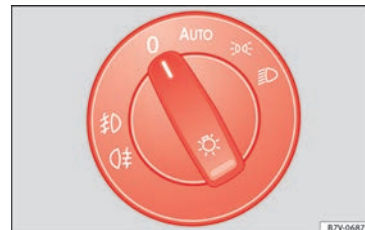


Fig. 40 Dash panel: light control.

Turn the switch to the required position
» » Fig. 40.



	When the ignition is switched off	When the ignition is on
0	Fog lights, dipped beam and side lights off.	Lights off or daytime driving light on.
AUTO	The guidance lights may be switched on.	Automatic dipped beam control or daytime driving light on.
☞☛	Side light on.	
☞	Dipped beam off; if necessary, the side light comes on for a time.	Dipped beam switched on.

☞ **Front fog lights:** move the switch to the first position, from positions **AUTO**, ☞☛ or ☞.

☞ **Rear fog light:** move the switch completely from positions **AUTO**, ☞☛ or ☞.

Switching off fog lights: Push the switch or turn it to the 0 position.



»»» ⚠ in Switching lights on and off on page 131



»»» page 130

Turn signal and main beam lever

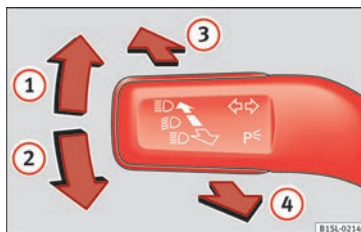


Fig. 41 Turn signal and main beam lever.

More the lever to the required position:

- ① Right turn signal: Right-hand parking light (ignition switched off).
- ② Left turn signal: Left-hand parking light (ignition switched off).
- ③ Main beam switched on: control lamp ☞ lit up on the instrument panel.
- ④ Headlight flasher: lit up when the lever is pushed. Control lamp ☞ lit up.

Lever all the way down to switch it off.



»»» ⚠ in Switching lights on and off on page 131



»»» page 131

Hazard warning lights



Fig. 42 Dash panel: switch for hazard warning lights.

Switched on, for example:

- When approaching a traffic jam
- In an emergency
- The vehicle has broken down
- When towing or being towed



»»» ⚠ in Hazard warning lights on page 135



»»» page 134

Interior lights

Button/Position: Function

0	Switches interior lights off.
	Switches interior lights on.
	Switches door contact control on (central position). The interior lights come on automatically when the vehicle is unlocked, a door is opened or the key is removed from the ignition. The lights go off a few seconds after all the doors are closed, the vehicle is locked or the ignition is switched on.
	Turning the reading light on and off



» page 136

Windscreen wipers and window wiper blade

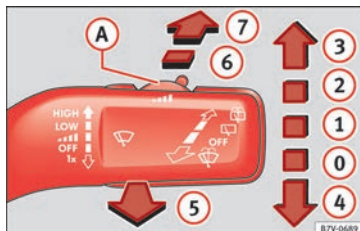


Fig. 43 Operating the windscreen wiper and rear wiper.

Move the lever to the required position

0	OFF	Windscreen wiper off.
1		Windscreen wipers interval wipe. Using the control » Fig. 43 (A) adjust the interval (vehicles without rain sensor), or the sensitivity of the rain sensor.
2	LOW	Slow wipe.
3	HIGH	Continuous wipe.
4	1x	Brief wipe - short wipe. Hold the lever down for more time to increase the wipe frequency.
5		Automatic wipe for cleaning wind-screens with the lever up.

Move the lever to the required position

6		Interval wipe for rear window. The wiper wipes the window at 6-second intervals.
7		Automatic wipe for cleaning rear windows with the lever pressed.



» ⚠ in Window wiper lever on page 137



» page 137

SOS

» page 55

SEAT information system

Introduction


With the ignition switched on, it is possible to read the different functions of the display by scrolling through the menus.

In vehicles with a multifunction steering wheel, there are no buttons on the windscreen wiper lever. The multifunction display can only be controlled from the buttons on the steering wheel.


The number of menus displayed on the instrument panel will vary according to the vehicle electronics and equipment. »

A specialised workshop will be able to programme or modify additional functions, according to the vehicle equipment. SEAT recommends taking your car in for technical service.

Some menu options can only be read when the vehicle is at a standstill.

As long as a priority 1 warning is displayed, it will not be possible to read the menus. To display the menus, confirm the warning by pressing .

Summary of the menu structure

- **Multifunction display (MFD) »» page 30**
 - Travelling time
 - Current fuel consumption
 - Average fuel consumption
 - Operating range
 - Distance covered
 - Average speed
 - Digital display of speed
 - Oil temperature digital display
 - Speed warning
- **Audio »» Booklet Radio or »» Booklet Navigation system**
- **Navigation »» Booklet Navigation system**
- **Telephone »» Booklet Radio or »» Booklet Navigation system**
- **Auxiliary heating »»  page 180**
- **Activation**
 - Programme On / Off
 - Disconnection
- **Timer 1-3**
 - Day
 - Time
 - Minute
 - Activate
- **Duration**
- **Operating mode**
 - Heat
 - Ventilation
- **Day**
- **Default setting**
- **Vehicle condition »» page 29**
- **Configuration »» page 31**
 - Multifunction display data
 - Travelling time
 - Current fuel consumption
 - Average fuel consumption
 - Distance covered
 - Operating range
 - Average speed
 - Digital display of speed
 - Speed warning
 - Compass
- **Convenience »» page 32**
 - Central locking system (Central locking)
 - Automatic lock (Auto. lock) On / Off
- **Automatic unlocking (Auto. unlock.) On / Off**
- **Unlocking doors (Door unlock.: All, One door, Vehicle side, Individual)**
 - Back
- **Electric windows**
 - Off
 - All
 - Driver
 - Back
- **Mirror angle (Mirror angle) On / Off**
- **Adjusting mirrors (Adjust. mirrors)**
 - Individual
 - Synchronised
 - Back
- **Factory settings (Factory settings)**
 - Back
- **Lights & visibility »» page 32**
 - Coming Home
 - Leaving Home
 - Footwell light
 - Convenience turn signals On / Off
 - Default setting
 - Tourist light On / Off
- **Time**
- **Winter tyres**
- **Language**
- **Units**
- **Second speed display On / Off**

- Autohold
- Service
- Info
- Reset
- Default setting

Using the menus on the instrument panel

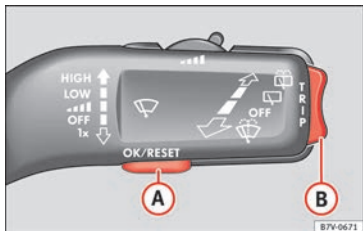


Fig. 44 Windscreen wiper lever: buttons to access the instrument panel menus



Fig. 45 Multifunction steering wheel: buttons to access the instrument panel menus

Enabling the main menu

- Switch the ignition on.
- If a message or vehicle symbol is displayed, press **OK** (» **Fig. 44 A** or » **Fig. 45**).
- *If managed from the windscreen wiper lever:* the main menu list is displayed.
- *If managed from the multifunction steering wheel:* the main menu list is not displayed. To scroll through the options of the main menu, press the arrow keys **<** or **>** repeatedly » **page 29**.

Select a submenu

- Press rocker switch » **Fig. 44 B** upwards or downwards, or, on the multifunction steering wheel, turn the thumbwheel until you reach the required menu option.

- The selected option is displayed between two horizontal lines. In addition, a triangle is displayed on the right ◀.
- To select the submenu, press **OK**.

Making changes according to the menu

- Use the rocker switch on the windscreen wiper lever or the thumbwheel on the multifunction steering wheel to make the required modifications. To scroll through numbers more quickly, hold the rocker switch down or turn the thumbwheel more quickly (fast forward or reverse).
- Mark or confirm the selected option with **OK**.

Main menu


MFD	Information and possible configurations of the multifunction display (MFD). » page 30
Audio	If the radio is on, the station is displayed. In CD mode, the current CD is played. » Booklet Radio or » Booklet navigation system

»

Navigation	When the navigation to destination is on, change of direction arrows and a proximity bar are displayed. These symbols are similar to those used in the navigation system. If navigation to destination is not on, the direction of travel (compass) and the name of the street on which you are driving are displayed. » Booklet Navigation system
Telephone	Information and possible configurations of the mobile phone preinstallation. » Booklet Radio or » Booklet Navigation system
Parking heating	Information and configurations of the parking heating: switching the parking heating on or off. Select the operating mode and duration. » page 180
Vehicle status	Current warning or information texts. This option only appears when one of the following texts is available. The number of available messages is displayed. Example 1/1 or 2/2. » page 102
Configuration	Different setting options, for example, the Convenience, Lighting & Visibility menus, and the time, speed warning with winter tyres, language, units of measurement, or "Display off". » page 31

MFD (multifunction display) menu

The multifunction display (MFD) has two automatic memories: **1 - Partial memory** and **2 - Total memory**. The selected memory will be shown in the upper right-hand corner of the display.

With the ignition switched on, and memory 1 or 2 displayed, briefly press  to change from one memory to another

1 Trip memory (for a single journey).	The memory stores the values for the journey and the consumption from the moment the ignition is switched on until it is switched off again. If the journey is broken for more than 2 hours, the memory is automatically erased. If the journey is continued in less than 2 hours after the ignition is switched off, the new data is added to the data already stored in the memory.
2 Total memory (for all journeys).	The memory records the values for a specific number of partial trips, up to a total of 19 hours and 59 minutes or 99 hours and 59 minutes, or 1999.9 km (or miles) for 9999 km (or miles), depending on the model of instrument panel. On reaching either of these limits, the memory is automatically erased and starts to count from 0 again.

Possible displays

Travelling time	This indicates the hours (h) and minutes (min) since the ignition was switched on.
------------------------	------------------------------------------------------------------------------------

Current fuel consumption	The current fuel consumption while driving is displayed in l/100 km (or miles per gallon, mpg); when the engine is running but the vehicle is not moving, in l/h (or gallons per hour).
Average fuel consumption	When the ignition is switched on, the average consumption (in l/100 km or in mpg) is displayed after the vehicle has moved approximately 100 metres (328 feet). Otherwise horizontal lines are displayed. The value shown is updated approximately every 5 seconds.
Operating range	Approximate distance in km (or miles) that can still be travelled with the fuel remaining in the tank, assuming the same style of driving is maintained. This is calculated using the current fuel consumption.
Distance covered	Distance travelled, after ignition is switched on, in km (or miles).
Average speed	After the ignition is switched on, the average speed will be shown after a distance of approximately 100 metres (328 feet) has been travelled. Otherwise horizontal lines are displayed. The value shown is updated approximately every 5 seconds.
Digital display of speed	Current speed displayed digitally.
Oil temperature digital display	Updated engine oil temperature digital display

Speed warning at --- km/h

If the stored speed is exceeded (between 30 - 250 km/h, or 18 - 155 mph), an audible warning is given together with a visual warning.

Changing between display modes

- *In vehicles without multifunction steering wheel:* press the lever.
- *Vehicles with a multifunction steering wheel:* press the Δ button or ∇ .

Storing a speed for the speed warning

- Select the display **Speed warning at --- km/h**.
- Press **OK** to store the current speed and switch off the warning.
- In addition, set the required speed by pressing the rocker switch on the windscreen wiper lever or using the Δ or ∇ buttons on the multifunction steering wheel during the subsequent 5 seconds. Next, press **OK** again or wait a few seconds. The speed is stored and the warning activated.
- *To switch off,* press **OK**. The stored speed is deleted.

Manually erasing memory 1 or 2

- Select the memory that you wish to erase.
- Hold down **OK** for approximately 2 seconds.

Personalising the displays


It is possible to select which of the displays in the multifunction display you wish to see on the instrument panel in the **settings** menu. The units of measurement can also be modified **»» page 31**.

Configuration Menu

Multifunction display data	Configuration of the multifunction display data that you wish to see on the instrument panel display »» page 30 .
Compass	Changing the magnetic region and calibration of the compass. To calibrate the compass, please follow the instructions given on the instrument panel display.
Convenience	Changing vehicle convenience functions »» page 32 .
Lights & visibility	Configuration of vehicle lighting »» page 32 .
Time	Changing the hours and minutes of the instrument panel clock and the navigation system. The time can be set here and the choice can be made between the 24-hour and 12-hour display. The S in the upper part of the display indicates that the clock is set to summer time.
Winter tyres	Changing the visual and audible speed warnings. This function should only be used when the vehicle is fitted with winter tyres, which are not designed for travel at high speeds.

Language	Changing the language of the display texts and the navigation system.
Units	Changing the units of measurement for the temperature, consumption and distance.
Second speed	Switching second speed display on and off.
Service	Check the service notifications or reset the service intervals to zero.
Factory settings	Some functions of the Configuration menu will be reset to the factory value.
Back	The main menu is displayed again.

Submenu Convenience

Central locking » page 114	<p>Auto lock (Auto Lock): automatic locking of all doors and boot when reaching a speed of approximately 15 km/h (10 mph). In order to unlock the vehicle when it is stopped, push the central locking button, pull the door handle or remove the key from the ignition lock if the Auto unlock function is enabled.</p> <p>Auto unlock (Auto Lock): Unlocking all doors and the boot by removing the ignition lock key.</p> <p>Door unlock: when unlocking the vehicle with the key, the following doors will unlock based on the setting: – All: all of the doors are unlocked. – One door: when unlocking the vehicle with the key, only the driver's door unlocks. Pressing the  button again unlocks all doors and the boot. – Vehicle side: the doors on the driver's side unlock. On vehicles fitted with the Keyless Access » page 114 system, when using the corresponding handle, all doors unlock on the side of the vehicle where the key is.</p>
	<p>Adjusting the electric windows: this enables the windows to be opened or closed when the vehicle is unlocked or locked respectively. The open function can only be activated from the driver door» page 127.</p>
Handling windows	

Rear vision mirror adjustment	Tilts passenger mirror downwards when reverse gear is engaged. This enables the driver to see the edge of the pavement, for example » page 140.
Exterior mirror adjust.	If synchronised adjustment is selected, when the driver side exterior mirror is adjusted, the passenger exterior mirror is also moved.
Factory settings	Some functions of the Convenience submenu will be reset to the factory value.
Back	The Configuration menu is displayed again.

Lights & visibility submenu

Coming Home	This permits the adjustment of the time the headlamps stay on after locking or unlocking the vehicle, the function can also be connected or disconnected here » page 133.
Leaving Home	
Footwell light	This permits the adjustment of the brightness of the footwell lighting when the doors are open, the function can also be connected or disconnected here
Convenience turn signals	Switching convenience turn signals on and off When the convenience turn signals are connected,, these flash at least three times when the turn signal is switched on » page 130.

Factory settings	All the configurations in the submenu Lights & visibility are reset to the predefined factory values.
Tourist light	Headlamp adjustment for countries in which vehicles are driven on the other side of the road. When the mark is activated, the headlamps of a left-hand drive vehicle are adjusted for driving on the left. This function must only be used for a short period.
Back	The Configuration menu is displayed again.

Personal convenience settings

When two people use a vehicle, SEAT recommends that each person always uses “their” own remote control key. When the ignition is switched off, or the vehicle is locked, the personal convenience settings are stored and automatically allocated to the vehicle key » page 27.

The values of the personalised convenience settings of the following menu options are allocated to the vehicle key:

- **Parking heating** menu
- **Configuration** Menu
 - Time
 - Language
 - Units
- **Convenience settings** menu

- Door unlock (individual opening, Auto Lock)
- Convenience handling of windows
- Rear vision mirror adjustment
- **Lights & visibility settings** menu
- Coming home and leaving home
- Footwell light
- Convenience turn signals

The stored settings are automatically activated, at the latest when the ignition is switched on. Please refer to the information and tips relating to the seat memory

»»  page 147.

Cruise control

Operating the cruise control system (CCS)*

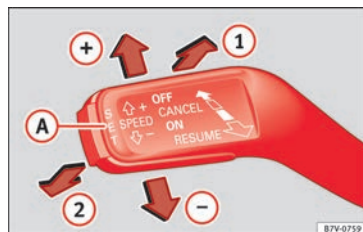


Fig. 46 On the left of the steering column: switches and controls for operating the CCS

- Switching on the CCS: move the lever to **ON** **1** »» **Fig. 46**. The system switches on but it does not control the speed as no speed has been programmed.
- Activating the CCS: press the **SET** **A** »» **Fig. 46** button. It memorises and maintains the current speed.
- Temporarily switching off the CCS: move the lever to **CANCEL** **2** »» **Fig. 46** and release it or press the brake or clutch pedal. The cruise control system is switched off temporarily.
- Reactivating the CCS: move the lever to **RESUME** **1** »» **Fig. 46** and release it. The memorised speed is saved and controlled again.

• Increasing stored speed during CCS regulation: briefly move the lever toward **SPEED +** **+** to increase the speed by 10 km/h intervals. By holding it down, the vehicle will accelerate to the desired speed. Release the button to store the current speed.

• Reducing stored speed during CCS regulation: briefly move the lever toward **SPEED -** **-** to decrease the speed by 10 km/h intervals. By holding it down the vehicle will slow down, ceasing to accelerate but not applying the brakes. Release the button to store the current speed.

• Switching off the CCS: move the lever to position **OFF** **2** »» **Fig. 46**. The system is disconnected and the memorised speed is deleted.



»»  in Cruise control system operation on page 222













»» page 221

Warning lamps









Control and warning lamps












Red warning lamps




	Do not continue driving! The electronic parking brake is on, the brake fluid level is too low or the brake system is faulty.	» page 188
	Do not continue driving! Fault in the engine cooling system.	» page 277
	Do not continue driving! Engine oil pressure too low.	» page 274
	Do not continue driving! At least one of the vehicles doors is open, or is not correctly closed.	» page 121
	Do not continue driving! The rear lid is open or is incorrectly closed.	» page 124
	Do not continue driving! Fault in the steering.	» page 198
	Engine cannot be started again! "AdBlue" too low.	» page 268
	Driver or passenger has not fastened seat belt.	» page 65

	Use the foot brake!	Change » page 193 Brake » page 188
	Faulty generator.	» page 283








Yellow warning lamps






	Front brake pads worn.	» page 188
	<i>lights up:</i> ESC malfunction or off. <i>flashes:</i> ESC working.	
	ASR manually deactivated.	» page 188
	ABS faulty or does not work.	
	Electronic parking brake faulty.	» page 188
	Rear fog light switched on.	» page 130
	<i>lights up:</i> Driving light totally or partially faulty.	» page 92
	<i>flashes:</i> Fault in the adaptive light system.	» page 130

	<i>lights up or flashes:</i> fault in the emission control system.	» page 202
	<i>lights up:</i> pre-heating of diesel engine. <i>flashes:</i> fault in the diesel engine management.	
EPC	fault in the petrol engine management.	» page 198
	Diesel particulate filter blocked	
	Fault in the steering system.	» page 287
	Tyre pressure too low. Fault in the tyre pressure gauge.	» page 234
	Level of windscreen washer fluid too low.	» page 137
	Fuel tank almost empty.	» page 264
	<i>flashes:</i> engine oil sensor faulty.	» page 274
	<i>lights up:</i> insufficient engine oil.	
	Fault in airbag system and seat belt tensioners.	» page 73
OFF 	Front passenger front airbag is disabled (PASSENGER AIR BAG OFF).	» page 73


	Top up "AdBlue", or there is a fault in the "AdBlue" system.	» page 268
	Fuel tank not closed correctly.	» page 264
	Lane Assist is switched on, but not active.	» page 223

Other warning lamps

	Left or right turn signal.	» page 130
	Hazard warning lights on.	» page 134
	Use the foot brake!	Change » page 193 Brake » page 188
	Cruise control operating.	» page 221
	Lane Assist is switched on and active.	» page 223
	Main beam on or flasher on.	» page 130
	Headlight adjustment (Light Assist) on.	» page 130
SAFE	Electronic immobiliser active.	» page 183
	Service interval display	» page 105

	Mobile telephone is connected via Bluetooth to the original telephone device.	» Booklet Radio or » Booklet Navigation system
	Mobile telephone battery charge meter. Available only for pre-installed factory-fitted devices.	
	Freezing warning. The outside temperature is lower than +4°C (+39°F).	» page 104
	Start-Stop system activated.	» page 209
	Start-Stop system unavailable.	



»  in Control and warning lamps on page 107



» page 107

Gearbox lever

Manual gearbox

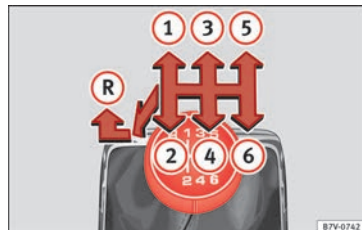



Fig. 47 Gear shift pattern of a 6-speed manual gearbox

The position of the gears is indicated on the gearbox lever » **Fig. 47**.

- Press the clutch pedal and keep your foot right down.
- Move the gearbox lever to the required position.
- Release the clutch.

Selecting reverse gear

- Press the clutch pedal and keep your foot right down.
 - With the gearbox lever in neutral, push it downwards, move it to the left as far as it will go and then forwards to select reverse
- » **Fig. 47** .

- Release the clutch.



» » in Manual gear change on page 194



» » page 193



» » in Automatic gearbox* on page 195



» » page 194

SOS

» » page 36

Automatic gearbox*



Fig. 48 Automatic gearbox: selector lever positions.

P Parking lock

R Reverse gear

N Neutral (idling)

D/S Drive (forward)

+/- Tiptronic mode: pull the lever forwards (+) to go up a gear or backwards (-) to go down a gear.

Manual release of the selector lever

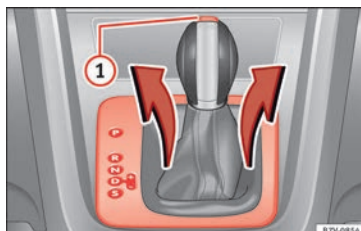


Fig. 49 Remove the lining from the area of the gear indication

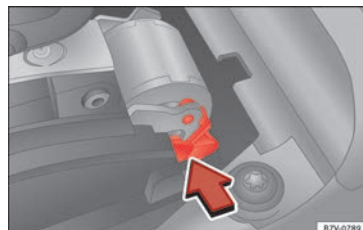


Fig. 50 Manual release of gear selector lever

If the vehicle power supply should ever fail (e.g. discharged battery) and the vehicle has to be pushed or towed, the selector lever must first be moved to position **N** using the manual release mechanism.

The emergency release mechanism is located underneath the gearbox cover panel to the right-hand side. To release the gear selector lever mechanism, a suitable tool is required, (e.g. a screwdriver).

Preparations

- Apply the parking brake. If the brake cannot be activated, the vehicle must be alternatively secured so that it cannot move.
- Switch the ignition off.

To remove the gearbox cover panel

- Pull the cover up around the dust guard on the gear selector lever » » **Fig. 49**.

- Take the cover off by passing it over the gear selector lever»» ⚠.

Manual release of the selector lever

- Press the release lever»» Fig. 50 in the direction of the arrow and hold it in this position.
- Press the lock button»» Fig. 49 ① on the gear selector lever knob and place the gear selector lever in the N position.

⚠ WARNING

Never move the gear selector lever from the position P while the electronic parking brake is deactivated. Otherwise, the vehicle may accidentally move off on hills or steep slopes causing serious accidents.

ⓘ CAUTION

If the vehicle is moved on its wheels with the engine stopped and the selector lever in position N for a prolonged period of time and at

high speed, for example for towing, then the automatic gearbox will be damaged.

Air conditioning

How does the air conditioning work?

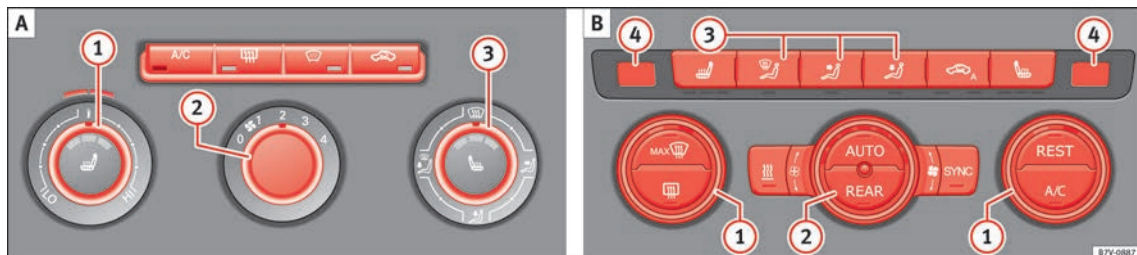














Fig. 51 Detailed view of the centre console: A Electronic manual air conditioning controls; B Climatronic controls.

The essentials

Control button	Electronic manual air conditioning  »» Fig. 51; Climatronic  »» Fig. 51.
 Temperature	Electronic manual air conditioning: rotate the control to adjust the temperature accordingly. In the A/C MAX position, the cooling output will be set to maximum. The air recirculation mode and the cooling system are automatically switched on. Climatronic: the left and right sides can be adjusted separately. Rotate the control to adjust the temperature accordingly.
 Fan	Electronic manual air conditioning: Setting 0: air fan and air conditioning system (manual) switched off, setting 4: maximum setting of fan. Climatronic: the power of the fan is automatically adjusted. Rotate the control to manually adjust the fan.
 Air distribution	Electronic manual air conditioning: rotate the continuous control to direct the airflow to the desired area. Climatronic: the airflow will be automatically adjusted to a comfortable flow. It can also be switched on manually with the buttons  .
	Climatronic: display of the selected interior temperature for the left and right sides.
	Electronic manual air conditioning: defrost function. The airflow is directed at the windscreen. In this position, air recirculation is automatically switched off or is not switched on. Increase the fan power to clear the windscreen of condensation as soon as possible. To dry the air, the cooling system will automatically switch on.
MAX 	Climatronic: defrost function. The air drawn in from outside the vehicle is directed at the windscreen and air recirculation is automatically switched off. To defrost the windscreen more quickly, the air is dehumidified at temperatures over approximately +3°C (+38°F) and the fan runs at maximum output.
	The air is directed at the chest of driver and passengers by the dash panel air vents.
	Air distribution towards the footwell.
	Electronic manual air conditioning: air distribution towards the windscreen and the footwell.
	Climatronic: upward air distribution.
	Heated rear window: only works when the engine is running and switches off automatically after a 10 minutes.
	Electronic manual air conditioning: air recirculation »» page 179.
 A	Climatronic: manual and automatic air recirculation »» page 179.
	Instant auxiliary heating on/off button »» page 180.

The essentials

Control button	Electronic manual air conditioning  »» Fig. 51; Climatronic  »» Fig. 51.
	Buttons for the seat heating »» page 147.
	Climatronic: depending on the vehicle equipment there may be a button for the windscreen heating on the air conditioner control panel. The windscreen heating only works when the engine is running and switches off automatically after a few minutes.
A/C	Press the button to switch on or off the cooling system.
SYNC	Climatronic: accept the temperature selection for the driver and front passenger sides. When the SYNC button light is lit, the temperature settings on the driver side also apply to the passenger side. Press the button or adjust the temperature control for the passenger side in order to set a different temperature. No lamp lights up on the button.
AUTO	Climatronic: automatic temperature, fan, and air distribution control. Press the button to switch on the function. The control lamp lights up on the AUTO button.
REAR	Climatronic: press the REAR button to adjust the air conditioner for the rear seats, from the front seats back. The lamp is lit on the REAR button if the feature is activated. The settings for the rear seats will be displayed. Press the button again to switch the function off or do not touch any other button for around 10 seconds.
REST	Climatronic: press the REAR button to use the heat that the engine produces. When the engine is still warm but the ignition switched off, the heat given off by the engine can be used to keep the vehicle interior warm. The REAR button will light up when the function is switched on. The function will switch off after around 30 minutes and if the battery level is low.
OFF^{a)}	Switch off. Electronic manual air conditioning: turn the fan switch to setting 0. Climatronic: Press the OFF button or adjust the fan manually to 0. The OFF button will light up when the device turns off.

^{a)} Depending on the version of the model.



»»  in Introduction on page 176



»» page 176

Fluid Level control

Filling capacities

Tank level

73 litres. 8 litre reserve

Capacity of the windscreen washer fluid container

Versions without headlight washer system	3.5 litres
Versions with headlight washer system	6 litres

Fuel

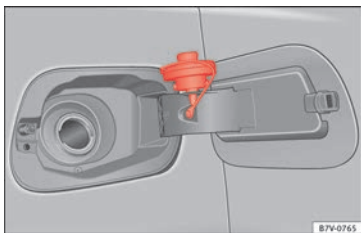


Fig. 52 Fuel tank flap with tank cap attached.

Before refuelling, always turn off the engine, the ignition, mobile telephones, auxiliary heating and keep them off during refuelling.

Opening the fuel tank cap

- The tank flap is at the rear of the vehicle on the right.
 - Press the rear of the tank flap to open it.
 - Unscrew the tank cap anticlockwise and insert it in the hole in the tank flap hinge
- » Fig. 236.

Closing the fuel tank cap

- Screw on the tank cap clockwise until it you hear it click into position.
- Press the tank flap until you hear it click into place. The tank flap must be flush with the body contour.



» page 264



» page 266

Oil

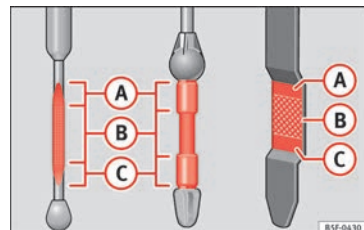


Fig. 53 Engine oil dipstick.



Fig. 54 In the engine compartment: Engine oil filler cap.

The level is measured using the dipstick located in the engine compartment

» page 274.

The oil should leave a mark between zones **(A)** and **(C)**. It should never exceed zone **(A)**.

- Zone **(A)**: Do not add oil.

- Zone **(B)**: You can add oil but keep the level in that zone.
- Zone **(C)**: Add oil up to zone **(B)**.

Topping up engine oil

- Unscrew cap from oil filler opening.
- Add oil slowly.
- At the same time, check the level to ensure you do not add too much.
- When the oil level reaches at least zone **(B)**, unscrew the engine oil filler cap carefully.

Motor oil specifications

Petrol engines

With LongLife service	VW 504 00
Without LongLife service	VW 504 00, VW 502 00

Diesel engines

With LongLife service	VW 507 00
Without LongLife service	VW 507 00

Engine oil additives

No type of additive should be mixed with the engine oil. The deterioration caused by these additives is not covered by the warranty.



» ⚠ in Topping up engine oil on page 277



» page 274

Coolant



Fig. 55 Engine compartment: coolant expansion tank cap.

The coolant tank is located in the engine compartment » page 274.

When the engine is cold, replace the coolant when the level is below **MIN**.

Coolant specifications

The engine cooling system is supplied from the factory with a specially treated mixture of water and at least 40 % of the additive **G13** (TL-VW 774 J), purple. This mixture gives the necessary frost protection down to -25°C

(-13°F) and protects the light alloy parts of the engine cooling system against corrosion. It also prevents scaling and considerably raises the boiling point of the coolant.

To protect the cooling system, the percentage of additive must always be at least 40 %, even in warm climates where anti-freeze protection is not required.

If for weather reasons further protection is necessary, the proportion of additive may be increased, but only up to 60 %; otherwise antifreeze protection will diminish and this will worsen cooling.

When the coolant is topped up, use a mixture of **distilled water** and at least 40 % of the G13 or G12 plus-plus (TL-VW 774 G) additive (both are purple) to obtain an optimum anti-corrosion protection » ⚠ in **Coolant specifications on page 279**. The mixture of G13 with G12 plus (TL-VW 774 F), G12 (red) or G11 (green-blue) engine coolants will significantly reduce anti-corrosion protection and should therefore be avoided » ⚠ in **Coolant specifications on page 279**.



» ⚠ in Coolant specifications on page 279



» page 277

Brake fluid



Fig. 56 Engine compartment: brake fluid reservoir cap.

The brake fluid reservoir is located in the engine compartment »» » page 274.

The level should be between the **MIN** and **MAX** marks. If it is below **MIN**, please visit a Technical Service.



»» » in Checking the brake fluid level on page 282



»» page 281

Windscreen washer



Fig. 57 In the engine compartment: windscreen washer reservoir top.

The windscreen washer reservoir is located in the engine compartment »» » page 274.

To top up, mix water with a product recommended by SEAT.

In cold temperatures, add anti-freeze.



»» » in Checking and topping up the windscreen washer reservoir on page 283



»» page 283

maintenance. It is checked as part of the Inspection Service.



»» » in Checking the electrolyte level of the vehicle battery on page 285



»» page 283

Battery

The battery is located in the engine compartment »» » page 274. It does not require

Emergencies

Fuses

Fuse location

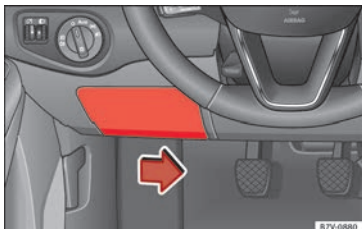


Fig. 58 On the driver-side dash panel: fuse box cover.



Fig. 59 In the engine compartment: fuse box cover.

Only replace fuses with a fuse of the same amperage (same colour and markings) and size.


Identifying fuses by colours

Colour	Amp rating
Purple	3
Light brown	5
Brown	7.5
Red	10
Blue	15
Yellow	20
White or transparent	25
Green	30
Orange	40

To open the dash panel fuse box

- To remove the cover, move the activation lever in the lower part to the right »» **Fig. 58**.
- For right-hand drive vehicles, move the lever to the left.

To open the engine compartment fuse box

- Open the bonnet »»  page 271.
- Move the attachment tabs forwards, in the direction indicated by the arrow to release the fuse box cover »» **Fig. 59**.

- Then lift the cover out.
- To **fit** the cover, place it on the fuse box. Push the attachment tabs back, in the opposite direction indicated by the arrow until they click audibly into place.

It is possible that there are more fuses behind a cover in the lower left-hand side of the luggage compartment.



»» page 91

Replacing a blown fuse

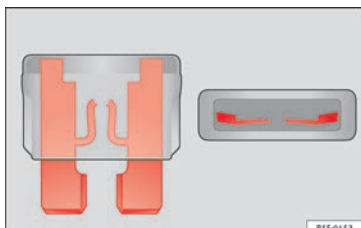


Fig. 60 Image of a blown fuse.

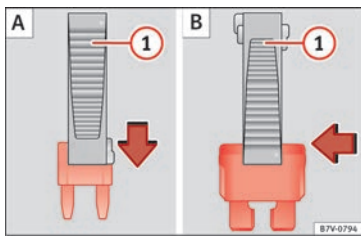


Fig. 61 Removing or fitting a fuse

Preparation

- Switch off the ignition, lights and all electrical equipment.
- Open the corresponding fuse box
»» page 43

Identifying a blown fuse

A fuse is blown if its metal strip is ruptured
»» Fig. 60.

- Point a lamp at the fuse to see if it has blown.

To replace a fuse

- If necessary, remove the plastic pincers from the fuse box cover.
- *Small fuses:* lock the pincer in from above
»» Fig. 61 A.
- *Larger fuses:* move the pincer sideways over the fuse
»» Fig. 61 B.
- Remove the relevant fuse.
- Replace the blown fuse by one with an *identical* amperage rating (same colour and markings) and *identical* size.
- Replace the cover.

Bulbs

Bulbs (12 V)

Full-LED headlights are designed to last the lifetime of the car and light bulbs cannot be replaced. In case of headlight failure, go to an authorised workshop to have it replaced.

Light source used for each function

Halogen headlights.	Type
Dipped beam headlights	H7 LL
Main beam headlights/daytime running lights (DRL)	H15 (double element)
Side lights	W5W
Turn signal	PY21W NA LL

AFS bi-xenon main headlight	Type
Daytime running lights (DRL)	P21W SLL
Side lights	W5W
Turn signal	PY21W NA LL
Dipped beam / Main beam	Xenon bulb. Visit an authorised workshop for replacement.

Front fog light	Type
Fog lights	HB4


LED rear lights	Type
Side/brake light	LED
Turn signal	WY21W
Reverse lights	W16W

Action in the event of a puncture

What to do first

The SEAT Alhambra is equipped as standard with anti-puncture technology tyres (Conti-Seal). In the event of a puncture or air leak of up to 5 mm, the tyre seals the hole with a protective layer inside the tread.

The inclusion of this technology means that there is no type of spare wheel included in the vehicle's equipment.

- Park the vehicle on a horizontal surface and in a safe place as far away from traffic as possible.
- Apply the handbrake.
- Switch on the hazard warning lights.
- *Manual gearbox:* select the 1st gear.
- *Automatic gearbox:* Move the selector lever to position P.
- If you are towing a trailer, unhitch it from your vehicle.
- Keep the vehicle tool kit ready*
»»  page 83.
- Observe the applicable legislation for each country (reflective vest, warning triangles, etc.).

- All occupants should leave the vehicle and wait in a safe place (for instance behind the roadside crash barrier).

WARNING

- Always observe the above steps and protect yourself and other road users.
- If you change the wheel on a slope, block the wheel on the opposite side of the car with a stone or similar to prevent the vehicle from moving.

Repairing a tyre with the anti-puncture kit*

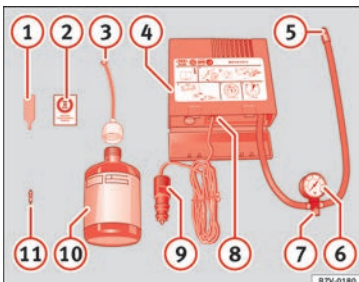












Fig. 62 Standard representation: contents of the anti-puncture kit.

The anti-puncture kit is located under the floor panel in the luggage compartment.


Sealing the tyre

- Unscrew the tyre valve cap and insert. Use the »» Fig. 62  tool to remove the insert. Place it on a clean surface.
- Shake the tyre sealant bottle vigorously
»» Fig. 62 .
- Screw the inflator tube »» Fig. 62  into the sealant bottle. The bottle's seal will break automatically.
- Remove the lid from the filling tube
»» Fig. 62  and screw the open end of the tube into the tyre valve.
- With the tyre sealant bottle upside down, fill the tyre with the contents of the sealant bottle.
- Remove the bottle from the valve.
- Place the insert back into the tyre valve using the tool »» Fig. 62 .

Inflating the tyre

- Screw the compressor tyre inflator tube
»» Fig. 62  into the tyre valve.
- Check that the air bleed screw is closed
»» Fig. 62 .
- Start the engine and leave it running.
- Insert the connector »» Fig. 62  into the vehicle's 12-volt socket »»  page 174.
- Turn the air compressor on with the ON/OFF switch »» Fig. 62 .

»»

- Keep the air compressor running until it reaches 2.0 to 2.5 bar (29-36 psi/200-250 kPa). **A maximum of 8 minutes.**
- Disconnect the air compressor.
- If it does not reach the pressure indicated, unscrew the tyre inflator tube from the valve.
- Move the vehicle 10m so that the sealant is distributed throughout the tyre.
- Screw the compressor tyre inflator into the valve.
- Repeat the inflation process.
- If the indicated pressure still cannot be reached, the tyre is too badly damaged. Stop and request assistance from an authorised technician.
- Disconnect the air compressor. Unscrew the tyre inflator tube from the tyre valve.
- When the tyre pressure is between 2.5 and 2.0 bars, continue driving without exceeding 80 km/h (50 mph).
- Check the pressure again after 10 minutes
»  page 87.



»  in TMS (Tyre Mobility System)* on page 86



» page 86

Changing a wheel

Vehicle tool kit*

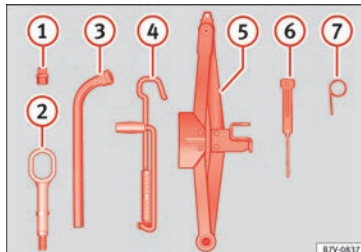


Fig. 63 Underneath the floor panel of the luggage compartment: vehicle tool kit.

- 1 Adapter for anti-theft bolt
- 2 Towing eye, removable
- 3 Box for wheel bolts
- 4 Crank handle for jack
- 5 Jack
- 6 Screwdriver with hexagon socket in the handle
- 7 Hook for pulling off wheel trims or wheel bolt caps.



»  in Location on page 83



» page 83

Full hubcaps*

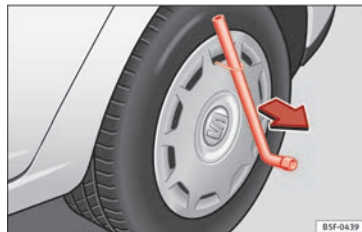



Fig. 64 Removing the full hubcap

Removing the full hubcap

- Take the wheel brace and the wire hook from the vehicle tool kit »  page 83.
- Hook the wire through one of the grooves on the hubcap.
- Insert the wheel brace onto the wire hook » **Fig. 64** and pull the hub cap in the direction shown by the arrow.

Fitting hubcaps

Before mounting the full trim, the anti-theft wheel lock must be threaded into position » **Fig. 67** ② or ③. Otherwise it will not be possible to mount the full hubcap.

- Press the trim against the wheel so that the space for the valve fits over the tyre valve » **Fig. 67** ①. Make sure that the hubcap is correctly fitted all the way around the wheel.

Wheel bolt caps

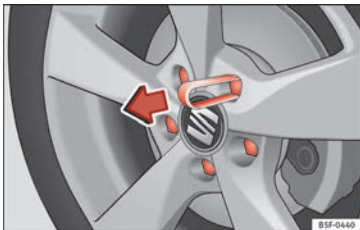


Fig. 65 Clip for removing the wheel bolt caps

Removal

- Fit the plastic clip (vehicle tools) over the cap until it clicks into place » **Fig. 65**.
- Remove the cap with the plastic clip.

The caps protect the wheel bolts and should be remounted after changing the tyre.

The **anti-theft wheel locking bolt** has a special cap. This only fits on anti-theft locking bolts and is not for use with standard wheel bolts.

Loosening the wheel bolts



Fig. 66 Changing a wheel: Slacken the wheel bolts.

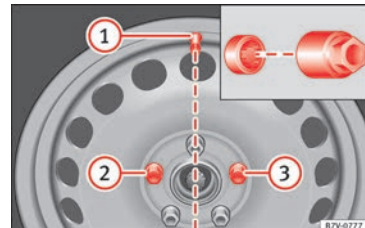


Fig. 67 Changing a wheel: tyre valve ① and position of anti-theft wheel locking bolt ② or ③.

Only use the tool supplied with the vehicle to loosen the wheel bolts.

Loosen the wheel bolts only about one turn before raising the vehicle with the jack.

If the wheel bolt is very tight, you may be able to loosen it by pushing down on the end of the wheel brace carefully with your foot. Hold on to the vehicle for support and take care not to slip.

Loosening wheel bolts

- Fit the wheel brace as far as it will go over the wheel bolt » **Fig. 66**.
- Hold the wheel brace at the end and rotate the bolt approximately *one* turn anticlockwise » **△**.

Loosening anti-theft wheel bolts

For wheels with full trim, the anti-theft wheel lock must be threaded into position »» Fig. 67 ② or ③. Otherwise it will not be possible to mount the entire hubcap.

- Take the adapter for anti-theft wheel bolts out of the vehicle tool kit.
- Insert the adapter onto the anti-theft wheel bolt.
- Fit the wheel brace onto the adapter as far as possible.
- Hold the wheel brace at the end and rotate the bolt approximately *one* turn anticlockwise »» ⚠.

Important information about wheel bolts

The wheel rims and bolts have been designed to be fitted to factory options. If different rims are fitted, the correct wheel bolts with the right length and correctly shaped bolt heads must be used. This ensures that wheels are fitted securely and that the brake system functions correctly.

In some circumstances, wheel bolts from the same model vehicle should not be used.

Wheel bolt tightening torque

The prescribed tightening torque for wheel bolts for steel and alloy wheels is **140 Nm**. Have the tightening torque of the wheel bolts

checked as soon as possible with a reliable torque wrench.

If wheel bolts are rusty and it is difficult to tighten them, the threads should be replaced and cleaned **before checking the tightening torque**.

Never grease or lubricate wheel bolts or the wheel hub threads. Although they have been tightened to the prescribed torque, they could come loose while driving.

⚠ WARNING

If the wheel bolts are not fitted correctly they could be released while driving leading to loss of vehicle control and serious damage.

- Only use wheel bolts which correspond to the wheel rims in question.
- Never use different wheel bolts.
- The bolts and threads should be clean, free of oil and grease and easy to thread.
- To loosen and tighten the wheel bolts, always use the wheel brace supplied with the vehicle.
- Loosen the wheel bolts only about one turn before raising the vehicle with the jack.
- Never grease or lubricate wheel bolts or the wheel hub threads. Although they have been tightened to the prescribed torque, they could come loose while driving.
- Never loosen the bolted joints of wheel rims with bolted ring trims.

- If the wheel bolts are not tightened to the correct torque, they may come loose while driving, and the bolts and rims may come out. If the tightening torque is too high, the wheel bolts and threads can be damaged.

Raising the vehicle with the jack

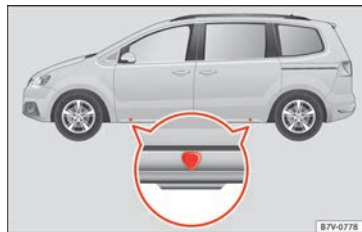


Fig. 68 Jack position points.

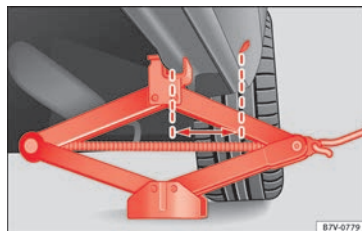


Fig. 69 Jack mounted on the left rear part of the vehicle

The jack may be applied only at the jacking points shown (marks on chassis) » **Fig. 68**. The mark indicates the jacking points **below** the vehicle. The jacking points are on the ribs **behind** the front edges » **Fig. 69**. Always the relevant jacking point for the wheel to be changed » **▲**.

Raise the vehicle using only the designated jacking points.

For your own safety and that of other passengers, the following points should be observed in the order given:

1. Select a suitable flat and firm surface for raising the vehicle.
2. Switch off the engine, engage a gear (manual gearbox) or place the selector lever in position **P** » **🔧** page 193 and turn on the electronic parking brake » **🔧** page 188.
3. Block the wheel diagonally opposite the wheel being changed with folding wheel chocks* or other suitable objects.
4. When towing a trailer: unhook the trailer from the towing vehicle and park it correctly.
5. Loosen the wheel bolts on the wheel to be changed » **page 47**.
6. Look below the vehicle for the jacking point » **Fig. 68** closest to the tyre which has to be changed.

7. Raise the jack with the handle until it can be inserted below the jacking point.
8. Ensure that the foot of the jack is firmly on the ground and that it is placed immediately below the lifting point on the vehicle » **Fig. 69**.
9. Straighten the jack and continue raising it using the handle until the claw holds the vertical reinforcement beneath the vehicle » **Fig. 69**.
10. Raise the vehicle until the wheel is clear of the ground.

▲ WARNING

If the vehicle is not correctly raised, it could fall off the jack causing serious injury. Please observe the following rules to minimise the risk of injury:

- You should only use a jack approved by SEAT for your vehicle. Other jacks, even those approved for other SEAT models, might slip out of place.
- The ground should be firm and flat. If the ground is sloped or soft then the vehicle could slip and fall off the jack. If necessary, support the jack on a wide solid base.
- If the ground is slippery, such as tiles, place a non-slip surface (a floor mat, for instance) beneath the jack to avoid slipping.
- Only fit the jack at the prescribed jacking points. The claw of the jack should grip the reinforcement nerve on the underbody » **Fig. 69**.

- You should never place a body limb such as an arm or leg under a raised vehicle that is solely supported by the jack.
- If you have to work underneath the vehicle, you must use suitable stands additionally to support the vehicle, there is a risk of accident!
- Never raise the vehicle if it is tilting to one side or the engine is running.
- Never start the engine when the vehicle is raised. The vehicle may come loose from the jack due to the engine vibrations.

Removing and fitting the wheel



Fig. 70 Changing a wheel: loosen wheel bolts with the socket at the end of the wheel brace

Removing the wheel

- Slacken the wheel bolts » **page 47**.
- Raise the vehicle » **page 48**.



- Using the hexagonal socket in the wheel brace » **Fig. 70**, unscrew the slackened wheel bolts and place them on a clean surface.
- Take off the wheel.

Putting on the spare wheel

Check the direction of rotation of the tyre » **page 50**.

- Fit the wheel.
- Screw on the anti-theft locking bolt with the adapter in position » **Fig. 67** ② or ③ clockwise and tighten gently.
- Replace the other wheel bolts and tighten *slightly* using the hexagonal socket on the end of the wheel brace.
- Lower the car with the jack.
- Tighten all of the wheel bolts clockwise » **▲**. Tighten the bolts in diagonal pairs (not in a circle).
- Put the caps, trim or full hubcap back on » **page 46**.

▲ WARNING

If the wheel bolts are not treated suitably or not tightened to the correct torque then this could lead to loss of vehicle control and to a serious accident.

- **All the wheel bolts and hub threads should be clean and free of oil and grease. The wheel**

bolts should be easily tightened to the correct torque.

- **The hexagonal socket in the wheel brace should be used for turning wheel bolts only. Do not use it to loosen or tighten the wheel bolts.**

Tyres with directional tread pattern

Tyres with directional tread pattern have been designed to operate best when rotating in only one direction. An arrow on the tyre sidewall indicates the direction of rotation on tyres with directional tread » **page 294**. Always observe the indicated direction of rotation in order to guarantee optimum grip and help avoid aquaplaning, excessive noise and wear.

If the tyre is mounted in the opposite direction of rotation, drive with extreme caution, as the tyre is no longer being used correctly. This is of particular importance when the road surface is wet. Change the tyre as soon as possible or remount it with the correct direction of rotation.

Subsequent work

- *On alloy wheels:* replace the wheel bolt caps.
- *On plate wheels:* replace the wheel hubcap.

- Return all tools to their proper storing location » **page 83**.
- Check the tyre pressure of the newly mounted tyre as soon as possible.
- If the vehicle is fitted with a tyre monitoring system, this should be “reprogrammed” if necessary whenever a tyre is changed » **page 234**.
- Have the tightening torque of the wheel bolts checked as soon as possible with a torque wrench » **page 48**. Meanwhile, drive carefully.

Snow chains

Use

When using snow chains, applicable local legislation and maximum permitted speed limits must be observed.

In winter weather, snow chains not only help to improve grip but also improve the braking capacity.

Snow chains must only be mounted **on the front wheels**, even on **all-wheel drive** vehicles, and only with the tyre and rim combinations listed below:

Tyre size	Wheel rim
205/60 R16	6 1/2 J x 16 ET 33

SEAT recommends you ask a technical service for further information on wheel, tyre and chain sizes.

Wherever possible use fine-link chains measuring less than 15 mm (3/4 inch) including the lock.

Remove wheel hub covers and trim rings before fitting snow chains » ❶. The wheel bolts should be covered with caps for safety reasons. These are available from technical services.

⚠ WARNING

The use of unsuitable or incorrectly fitted chains could lead to serious accidents and damage.

- Always use the appropriate snow chains.
- Observe the fitting instructions provided by the snow chain manufacturer.
- Never exceed the maximum permitted speeds when driving with snow chains.

⚠ CAUTION

- Remove the snow chains to drive on roads without snow. Otherwise they will impair handling, damage the tyres and wear out very quickly.
- Wheel rims may be damaged or scratched if the chains come into direct contact with them. SEAT recommends the use of covered snow chains.

❗ Note

Snow chains are available in different sizes according to the vehicle type.

Emergency towing of the vehicle

Towing




Fig. 71 On the right-hand side of the front bumper: Screw in the towline anchorage.



Fig. 72 On the rear bumper, to the right hand side: Towline anchorage in position

Towline anchorages

Attach the bar or rope to the towline anchorages.

They are located with the vehicle's tools »  page 83.


Screw the towline anchorage into the screw connection » **Fig. 71** » **Fig. 72** and tighten it with the wheel brace.

Tow rope or tow bar

When towing, the tow bar is the safest and vehicle friendly way. You should only use a tow rope if you do not have a tow bar.

A tow rope should be slightly elastic to avoid damage to both vehicles. It is advisable to use a tow rope made of synthetic fibre or similarly elastic material. »

Only secure the tow rope or tow bar to the towline anchorage or specially designed fitting.

Vehicles with a **factory fitted towing device**, can **only** be used for towing with a tow bar, specially designed to fit on a tow hitch ball
»  page 237.

Towing vehicles with an automatic gearbox

Note the following for a towed vehicle:

- Make sure the gear selector lever is in the **N** position.
- Do not drive faster than 50 km/h (30 mph).
- Do not tow further than 50 km (30 miles).
- If a breakdown truck is used, the vehicle must be towed with the front wheels raised. Note the following instructions for towing four all-wheel drive vehicles.

Instructions for towing all-wheel drive vehicles

All-wheel drive vehicles can be towed using a toolbar or tow rope. If the vehicle is towed with the front or rear axle raised, the engine must be turned off to avoid transmission damage.

For vehicles with a double clutched DSG® (direct shift gearbox) the instructions for towing vehicles with an automatic gearbox apply
» page 52.

Situations in which a vehicle should not be towed

In the following cases, the vehicle should not be towed but transported on a trailer or special vehicle:

- If the vehicle gearbox does not contain lubricant due to a fault.
- If the vehicle battery is flat and, as a result, the electronic steering lock and electronic parking brake cannot be disengaged if applied.
- If the vehicle to be towed has an automatic gearbox and the distance to be covered is greater than 50 km (30 miles).



»  in Introduction on page 88



» page 88

Tow-starting

In general, the vehicle should not be started by towing. Jump-starting is much more preferable » page 52.

For technical reasons, the following vehicles can **not** be tow started:

- Vehicles with an automatic gearbox.

- Vehicles with the Keyless Access locking and ignition system, since the electronic steering lock may not unlock.

- Vehicles with an electronic parking brake, given that it is possible that the brake will not be disengaged.

- If the vehicle battery is flat, it is possible that the engine control units do not operate correctly.


However, if your vehicle must absolutely be tow-started (manual gearbox):

- Put it into second or third gear.
- Keep the clutch pressed down.
- Switch on the ignition and the hazard warning lights.
- Release the clutch when both vehicles are moving.
- As soon as the engine starts, press the clutch and move the gear lever into neutral. This helps to prevent a collision with the towing vehicle.

How to jump start

Jump leads

If the engine fails to start because of a discharged battery, the battery of another vehicle can be used to start the engine. Before

starting, check the magic eye on the battery
»  page 283.

For starting assistance, jump lead cables conforming to the standard DIN 72553 are required (see the cable manufacturer instructions). The jump lead cable must be at least 25 mm² in section (0,038 inches²) for petrol engines, and 35 mm² (0,054 inches²) for diesel engines.

For vehicles whose battery is not in the engine compartment, the jump leads should only be connected to the starting assistance connection points in the engine compartment.

WARNING

Incorrect use of jump leads and incorrectly jump starting could cause the battery to explode resulting in serious injury. Please observe the following rules to minimise the risk of a battery explosion:

- The battery providing current must have the same voltage (12V) and approximately the same capacity (see markings on battery) as the flat battery.
- Never charge a frozen or recently thawed battery. A flat battery can also freeze at temperatures close to 0°C (+32°F).
- If a battery is frozen and/or has been frozen then it must be replaced.
- A highly explosive mixture of gases is released when the battery is being charged. Al-

ways keep lit cigarettes, flames, sparks and fire far from the battery. Never use a mobile telephone when connecting and removing the jump leads.

- Charge the battery only in well ventilated areas given that when the battery is charged by outside assistance, it creates a mix of highly explosive gases.
- Jump leads should never enter into contact with moving parts in the engine compartment.
- Never switch the positive and negative poles or connect the jump leads incorrectly.
- Note the instruction manual provided by the manufacturer of the jump leads.

CAUTION

To avoid considerable damage to the vehicle electrical system, note the following carefully:

- If the jump leads are incorrectly connected, this could result in a short circuit.
- The vehicles must not touch each other, otherwise electricity could flow as soon as the positive terminals are connected.

Positive pole on the jump lead connection points

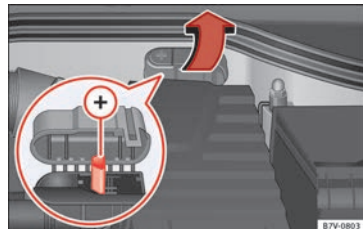



Fig. 73 In the engine compartment: positive pole for starting assistance .

On some vehicles, there is a starting assistance terminal in the engine compartment, under a labelled cover.

How to jump start: description

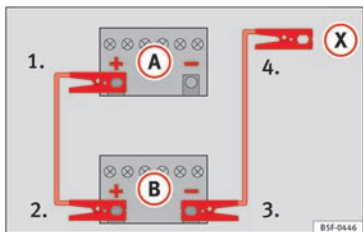


Fig. 74 Diagram of connections for vehicles without Start-Stop system.

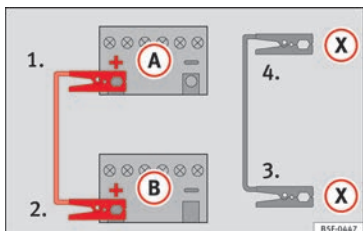


Fig. 75 Diagram of connections for vehicles with Start-Stop system.

Jump lead terminal connections

1. Switch off the ignition of both vehicles
»» ⚠

2. Connect one end of the **red** jump lead to the positive (+) terminal of the vehicle with the flat battery (A) »» Fig. 74.
3. Connect the other end of the **red** jump lead to the positive terminal (+) in the vehicle providing assistance (B).
- 4a. *For vehicles without Start-Stop system:* connect one end of the **black** jump lead to the negative terminal (-) of the vehicle providing the current (B) »» Fig. 74.
- 4b. *For vehicles with Start-Stop system:* connect one end of the **black** jump lead (X) to a suitable ground terminal, to a solid piece of metal in the engine block, or to the engine block itself »» Fig. 75.
5. Connect the other end of the **black** jump lead (X) to a solid metal component bolted to the engine block or to the engine block itself of the vehicle with the flat battery. Do not connect it to a point near the battery (A).
6. Position the leads in such a way that they cannot come into contact with any moving parts in the engine compartment.

Starting

7. Start the engine of the vehicle with the boosting battery and let it run at idling speed.

8. Start the engine of the vehicle with the flat battery and wait for 2 or 3 minutes until the engine is running.

Removing the jump leads

9. Before you remove the jump leads, switch off the dipped beam headlights if they are switched on.
10. Turn on the heater blower and heated rear window in the vehicle with the flat battery. This helps minimise voltage peaks which are generated when the leads are disconnected.
11. When the engine is running, disconnect the leads in reverse order to the details given above.

Make sure the battery clamps have sufficient metal-to-metal contact with the battery terminals.

If the engine fails to start after about 10 seconds, switch off the starter and try again after about 1 minute.

⚠ WARNING

- Please note the safety warnings referring to working in the engine compartment »» 📖 page 271.
- The battery providing assistance must have the same voltage as the flat battery (12V) and approximately the same capacity (see imprint on battery). Failure to comply could result in an explosion.

- Never use jump leads when one of the batteries is frozen. Danger of explosion! Even after the battery has thawed, battery acid could leak and cause chemical burns. If a battery freezes, it should be replaced.
- Keep sparks, flames and lighted cigarettes away from batteries, danger of explosion. Failure to comply could result in an explosion.
- Observe the instructions provided by the manufacturer of the jump leads.
- Do not connect the negative cable from the other vehicle directly to the negative terminal of the flat battery. The gas emitted from the battery could be ignited by sparks. Danger of explosion.
- Never attach the negative cable to fuel system components or the brake lines in the other vehicle.
- The non-insulated parts of the battery clamps must not be allowed to touch. The jump lead attached to the positive battery terminal must not touch metal parts of the vehicle, this can cause a short circuit.
- Position the leads in such a way that they cannot come into contact with any moving parts in the engine compartment.
- Do not lean on the batteries. This could result in chemical burns.



Note

The vehicles must not touch each other, otherwise electricity could flow as soon as the positive terminals are connected.

Changing windscreen wipers

Windscreen wipers service position

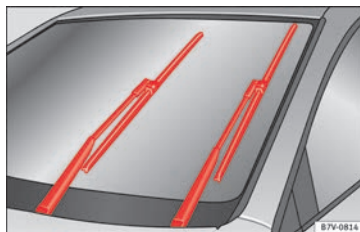


Fig. 76 Wipers in service position.

The wiper arms can be raised when the wipers are in service position »» Fig. 76.

- Close the bonnet »» page 271.
- Switch the ignition on and off.
- Press the windscreen wiper lever downwards briefly »» page 27 .

Before driving, always lower the wiper arms. Using the windscreen wiper lever, the wind-

screen wiper arms return to their initial position.



»» page 88

Changing the front wiper blades

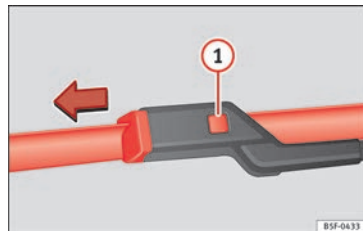


Fig. 77 Changing the front wiper blades

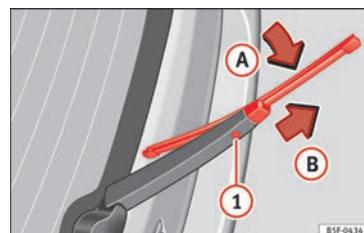


Fig. 78 Changing the rear wiper blade



Cleaning windscreen wiper blades

- Lifting and unfolding the wiper arms.
- Use a soft cloth to remove dust and dirt from the wiper blades.
- If the blades are very dirty, a sponge or damp cloth may be used » » ❶ in **Changing the windscreen and rear window wiper blades on page 88.**

Change the windscreen wiper blades

- Lifting and unfolding the wiper arms.
- Press and hold release button » » Fig. 77 ❶ and pull gently on the wiper blade in the direction of the arrow.
- Fit a new wiper blade **of the same length and design** on to the wiper arm and hook it into place.
- Rest the wiper arms back onto the windscreen.

Lifting and unfolding the wiper arms

The wiper arm may **only** be lifted at the point where it is fastened to the blade.

Changing the rear wiper blade

- Lift and unfold the wiper arm.
- Pull the wiper blade out of its mounting on the wiper arm » » Fig. 78 (arrow A).
- Hold down the release button » » Fig. 78 ❶ while gently pulling the blade in the direction of arrow B. This may require some strength.

- Insert a new blade of the **same length and type** in the wiper arm in the opposite direction to the arrow » » Fig. 78 B and hook into place. This feature is operational when the knob is in position (arrow A).
- Replace the wiper arm on the rear window.



» » ⚠ in Changing the windscreen and rear window wiper blades on page 88



» » page 88

Safety

Safe driving

Safety first!

This chapter contains important information, tips, suggestions and warnings that you should read and consider for both your own safety and for your passengers' safety.

WARNING

- This manual contains important information about the operation of the vehicle, both for the driver and the passengers. The other sections of the on-board documentation also contain further information that you should be aware of for your own safety and for the safety of your passengers.
- Ensure that the on-board documentation is kept in the vehicle at all times. This is especially important when lending or selling the vehicle to another person.

Advice about driving

Introduction

Depending upon how you expect to use your vehicle, it may be a good idea to protect the engine from below. An undercarriage may help

to reduce the risk of damage to the lower part of the vehicle and the oil sump when driving over kerbs, or along dirt tracks or unsurfaced roads, etc. SEAT recommends you have the guard fitted by a technical service centre.

WARNING

Driving under the influence of alcohol, drugs, medication or narcotics may result in severe accidents and even loss of life.

- Alcohol, drugs, medication and narcotics may significantly alter perception, affect reaction times and safety while driving, which could result in the loss of control of the vehicle.


Before setting off

For your own safety and the safety of your passengers, always note the following points before every trip:

- Make sure that the vehicle's lights and turn signals are working properly.
- Check tyre pressure.
- Ensure that all windows provide a clear and good view of the surroundings.
- Make sure all luggage is secured »» page 152.
- Make sure that no objects can interfere with the pedals.

- Adjust front seat, head restraint and mirrors properly according to your size.
- Ensure that the passengers in the rear seats always have the head restraints in the in-use position »» page 144.
- Instruct passengers to adjust the head restraints according to their height.
- Protect children with appropriate child seats and properly applied seat belts »» page 75.
- Assume the correct sitting position. Instruct your passengers also to assume a proper sitting position »» page 58.
- Fasten your seat belt securely. Instruct your passengers also to fasten their seat belts properly »» page 65.

What affects driving safety?

As a driver, you are responsible for yourself and your passengers. When your concentration or driving safety is affected by any circumstance, you endanger yourself as well as others on the road »» , for this reason:

- Always pay attention to traffic and do not get distracted by passengers or telephone calls.
- Never drive when your driving ability is impaired (e.g. by medication, alcohol, drugs). »

- Observe traffic laws and speed limits.
- Always reduce your speed as appropriate for road, traffic and weather conditions.
- When travelling long distances, take breaks regularly - at least every two hours.
- If possible, avoid driving when you are tired or stressed.

WARNING

When driving safety is impaired during a trip, the risk of injury and accidents increases.

Safety equipment

Never put your safety or the safety of your passengers in danger. In the event of an accident, the safety equipment may reduce the risk of injury. The following points cover part of the safety equipment in your SEAT:

- three-point seat belts,
- belt tension limiters for the front and rear side seats,
- Belt tensioners for the front seats,
- front airbags,
- knee airbags,
- side airbags in the front seat backrests,
- side airbags in the rear seat backrests*,
- head-protection airbags,

- “ISOFIX” anchor points for child seats in the rear side seats with the “ISOFIX” system,
- height-adjustable front head restraints,
- belt height adjustment for the front seats,
- rear head restraints with in-use position and non-use position,
- adjustable steering column.

The safety equipment mentioned above works together to provide you and your passengers with the best possible protection in the event of an accident. However, these safety systems can only be effective if you and your passengers are sitting in a correct position and use this equipment properly.

Safety is everyone's business!

Correct position of the vehicle occupants

Correct sitting position

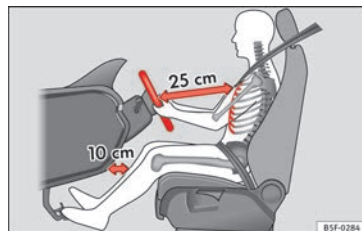


Fig. 79 The correct distance between the driver and the steering wheel must be at least 25 cm (10 inches).

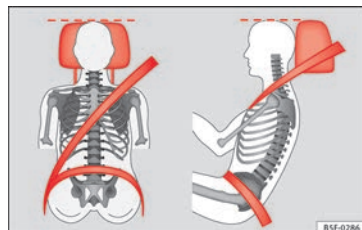


Fig. 80 Correct belt web and head restraint positions

The correct sitting positions for the driver and passengers are shown below.

If your physical constitution prevents you from maintaining the correct sitting position, contact a specialised workshop for help with any special devices. The seat belt and airbag can only provide optimum protection if a correct sitting position is adopted. SEAT recommends taking your car in for technical service.

For your own safety and to reduce the risk of injury in the event of an accident or sudden braking or manoeuvre, SEAT recommend the following positions:

Valid for all vehicle occupants:

- Adjust the head restraint so that its upper edge is at the same level as the top of your head, or as close as possible to the same level as the top of your head and under no circumstances below eye level. Keep the back of your neck as close as possible to the head restraint »» Fig. 79 and »» Fig. 80.
- Short people must lower the head restraint completely, even if your head is below its upper edge.
- Tall people must raise the head restraint completely.
- Adjust the seat backrest to an upright position so that your back rests completely against it.

- Always keep your feet in the footwell while the vehicle is in motion.
- Adjust and fasten your seat belt correctly »» page 65.


Also valid for the driver:

- Adjust the steering wheel so that there is a distance of at least 25 cm (10 inches) between it and your chest »» Fig. 79 and so that you can hold the steering wheel with both hands on the outside of the ring at the 9 o'clock and 3 o'clock positions with your arms slightly bent.
- The adjusted steering wheel must face your chest and not your face.
- Adjust the driver seat forwards or backwards so that you are able to press the accelerator, brake and clutch pedals to the floor with your knees slightly angled and the distance between your knees and the dash panel is at least 10 cm (4 inches) »» Fig. 79.
- Adjust the height of the driver seat so that you can easily reach the top of the steering wheel.
- Keep both feet in the footwell so that you have the vehicle under control at all times.

Also valid for the front passenger:



- Move the front passenger seat back as far as possible for optimum protection should the airbag deploy.

Adjusting the steering wheel position

Read the additional information carefully »»  page 18.

WARNING

Incorrect use of the steering wheel adjustment function and an incorrect adjustment of the steering wheel can result in severe or fatal injury.

- After adjusting the steering column, push the lever »»  Fig. 24  firmly upwards to ensure the steering wheel does not accidentally change position while driving.
- Never adjust the steering wheel while the vehicle is in motion. If you need to adjust the steering wheel while the vehicle is in motion, stop safely and make the proper adjustment.
- The adjusted steering wheel should be facing your chest and not your face so as not to hinder the driver's front airbag protection in the event of an accident.
- When driving, always hold the steering wheel with both hands on the outside of the ring at the 9 o'clock and 3 o'clock positions to reduce injuries when the driver's front airbag deploys.
- Never hold the steering wheel at the 12 o'clock position or in any other manner (e.g. in the centre of the steering wheel). In such cases, if the driver's airbag deploys, you may sustain injuries to your arms, hands and head.

Danger of injuries due to an incorrect sitting position

Number of seats

Depending on the equipment, your vehicle has a total of **five** or **seven** seats. Each seat is equipped with a seat belt.

5 seats

Seats in the front	Seats in the second row	Seats in the third row
2	3	–

7 seats

Seats in the front	Seats in the second row	Seats in the third row
2	3	2

If the seat belts are worn incorrectly or not at all, the risk of severe injuries increases. Seat belts can provide optimal protection only if the belt web is properly worn. Being seated in an incorrect position means the seat belt cannot offer its full protection. This could result in severe and even fatal injuries. The risk of severe or fatal injuries is especially heightened when a deploying airbag strikes a vehicle occupant who has assumed an incorrect sitting position. The driver is responsible for all passengers in the vehicle, particularly children.

The following list shows just some examples of incorrect sitting positions which can be dangerous to all vehicle occupants.

Whenever the vehicle is in motion:

- Never stand in the vehicle.
- Never stand on the seats.
- Never kneel on the seats.
- Never tilt your seat backrest too far to the rear.
- Never lean against the dash panel.
- Never lie on the rear bench.
- Never sit on the front edge of a seat.
- Never sit sideways.
- Never lean out of a window.
- Never put your feet out of a window.
- Never put your feet on the dash panel.
- Never put your feet on the surface of a seat or seat backrest.
- Never travel in a footwell.
- Never sit on the armrests.
- Never travel on a seat without wearing the seat belt.
- Never carry any person in the luggage compartment.

WARNING

An incorrect sitting position in the vehicle can lead to severe injuries or death in the

event of sudden braking or manoeuvres, collision or accidents or if the airbag deploys.

- Before the vehicle moves, assume the proper sitting position and maintain it throughout the trip. This also includes fastening the seat belt.
- Never transport more people than there are seats with a seat belt available in the vehicle.
- Children must always be protected with an approved child restraint system suited to their height and weight » page 75.
- Always keep your feet in the footwell while the vehicle is in motion. Never, for example, put your feet on the surface of a seat or on the dash panel and never put them out of a window. Otherwise the airbag and seat belt offer insufficient protection and the risk of injury in the event of an accident is increased.

WARNING

Before every trip, adjust the seat, the seat belt and the head restraints and instruct your passengers to fasten their seat belts properly.

- Move the front passenger seat back as far as possible.
- Adjust the driver seat so that there is a distance of at least 25 cm (10 inches) between the centre of your chest and the hub of the steering wheel. Adjust the driver seat so that you are able to press the accelerator, brake and clutch pedals to the floor with your knees slightly angled and that the distance

between your knees and the dash panel is at least 10 cm (4 inches). If your physical constitution prevents you from meeting these requirements, contact a specialised workshop to make any modifications required.

- Never drive with the seat backrest tilted far back. The further the seat backrests are tilted to the rear, the greater the risk of injury due to incorrect positioning of the belt web or to the incorrect sitting position!
- Never drive with the seat backrest tilted forwards. Should a front airbag deploy, it could throw the seat backrest backwards and injure the passengers of the rear seats.
- Sit as far away as possible from the steering wheel and the dash panel.
- Keep your back straight and resting completely against the seat backrest and the front seats correctly adjusted. Never place any part of your body in the area of the airbag or very close to it.
- If passengers on the rear seats are not sitting in an upright position, the risk of severe injury due to incorrect positioning of the belt web increases.

WARNING

Incorrect seat adjustment may lead to accidents and severe injuries.

- Only adjust the seats when the vehicle is stationary, as the seats could move unexpectedly while the vehicle is in motion and you could lose control of the vehicle. Further-

more, an incorrect position is adopted when adjusting the seat.

- Only adjust the height, seat backrest and forwards or backwards position of the seat when there is nobody in the seat adjustment area.
- There must be no objects blocking the seat adjustment area.
- Only adjust the height, angle and longitudinal position of the rear seats when nobody is in the way.
- The seat adjustment and lock areas must be kept clean.

Pedal area

Pedals

Do not allow floor mats or other objects to obstruct the free passage of the pedals.

Floor mats should leave the pedal area free and unobstructed and be correctly secured in the footwell zone.

In the event of failure of a brake circuit, the brake pedal must be pressed harder than normal to brake the vehicle.

WARNING

Objects falling into the driver's footwell could prevent use of the pedals. This could lead the

driver to lose control of the vehicle, increasing the risk of a serious accident.

- Make sure the pedals can be used at all times, with no objects rolling underneath them.
- Always secure the mat in the footwell.
- Never place other mats or rugs on top of the original mat supplied by the factory.
- Ensure that no objects can fall into the driver's footwell while the vehicle is in motion.

CAUTION

The pedals must always have free and unobstructed passage to the floor. For example, in case of a fault in the brake circuit, the brake pedal will need to be pressed further to stop the vehicle. To press the brake pedal down further will require more force than usual.

Seat belts

Why wear a seat belt

Introduction

Check the condition of all the seat belts at regular intervals. If you notice that the belt webbing, fittings, retractor mechanism or buckle of any of the belts is damaged, the belt must be replaced immediately by a specialised workshop »» △. The specialised workshop must use the appropriate spare parts corresponding to the vehicle, the equipment and the model year. SEAT recommends taking your car in for technical service.

△ WARNING

Unbuckled or badly buckled seat belts increase the risk of severe or even fatal injuries. The seat belt cannot offer its full protection if it is not fastened and used correctly.

- Seat belts are the most effective way of reducing the risk of sustaining severe or fatal injuries in the event of an accident. Seat belts must be correctly fastened when the vehicle is in motion to protect the driver and all vehicle occupants.
- Before each trip, every occupant in the vehicle occupants must sit properly, correctly fasten the seat belt belonging to his or her seat and keep it fastened throughout the trip.

This also applies to other vehicle occupants when driving in town.

- When travelling, children must be secured in the vehicle with a child restraint system suitable for their weight and height and with the seat belts correctly fastened »» page 75.
- Instruct your passengers to fasten their seat belts properly before driving off.
- Insert the latch plate into the buckle for the appropriate seat and ensure it is engaged. Using the latch plate in the buckle of another seat will not protect you properly and may cause severe injuries.
- Do not allow liquids or foreign bodies to enter the buckle fastenings. This could damage the buckles and seat belts.
- Never unbuckle your seat belt when the vehicle is moving.
- Never allow more than one passenger to share the same seat belt.
- Never hold children or babies on your lap sharing the same seat belt.
- Bulky and unbuttoned clothing, such as a coat worn over a sweatshirt, impairs the proper fit and function of the seat belt.

△ WARNING

It is extremely dangerous to drive using damaged seat belts and could result in serious injury or loss of life.

- Avoid damaging the seat belt by jamming it in the door or the seat mechanism.
- If the fabric or other parts of the seat belt are damaged, the seat belts could break in the event of an accident or sudden braking.
- Always have damaged seatbelts replaced immediately by seat belts approved for the vehicle in question by SEAT. Seat belts which have been worn in an accident and have been stretched must be replaced by a specialised workshop. Renewal may be necessary even if there is no apparent damage. The belt anchorage should also be checked.
- Never attempt to repair, modify or remove a seat belt yourself. All repairs to seat belts, retractors and buckles must be carried out by a specialised workshop.


Warning lamp




Fig. 81 Warning lamp on the instrument panel.




Fig. 82 Example of seat belt status display for the rear seats (here, a 7-seat vehicle) on the instrument panel above, the second row and, below, the third row of seats.


	Lights up or flashes
Driver's seat belt not fastened or front passenger seat belt not fastened if the front passenger seat is occupied.	Fasten seat belts!
Objects on the front passenger seat.	Remove any objects from the front passenger seat and store them safely.

Some control and warning lamps on the instrument panel will come on to check certain functions when the ignition is switched on. They will switch off after a few seconds.

An audible warning will be heard for a maximum of 90 seconds if the seat belts are not fastened as the car drives off and reaches a speed of more than 25 km/h (15 mph) or if the seat belts are unfastened while the vehicle is in motion. The seat belt warning lamp  will also flash.

The warning lamp  does not switch off until the driver and front passenger fasten their seat belts while the ignition is switched on.

Seat belt status display for rear seats

The seat belt status display on the instrument panel informs the driver, when the ignition is switched on, whether any passengers in the rear seats have fastened their seat belts. The  symbol indicates that the pas-

senger in this seat has fastened "his or her" seat belt **»» Fig. 82.**

The seat belt status is displayed for around 30 seconds when a seat belt in the rear seats is fastened or unfastened. You can switch off this display by pressing the **(0.0 / SET)** button.

The seat belt status flashes for a maximum of 30 seconds when a seat belt in the rear seats is unfastened while the vehicle is in motion. An audible warning will also be heard if the vehicle is travelling at over 25 km/h (15 mph).

The rear seat display can be enabled or disabled by a technical service centre.

The protective function of seat belts



Fig. 83 Drivers with properly worn seat belts will not be thrown forward in the event of sudden braking **»»**

Properly worn seat belts hold the occupants in the proper position. They also help prevent uncontrolled movements that may result in serious injury and reduce the risk of being thrown out of the vehicle in case of an accident.

Vehicle occupants wearing their seat belts correctly benefit greatly from the ability of the belts to absorb kinetic energy. In addition, the front part of your vehicle and other passive safety features (such as the airbag system) are designed to absorb the kinetic energy released in a collision. Taken together, all these features reduce the releasing kinetic energy and consequently, the risk of injury. This is why it is so important to fasten seat belts before every trip, even when "just driving around the corner".

Ensure that your passengers wear their seat belts as well. Accident statistics have shown that wearing seat belts is an effective means of substantially reducing the risk of injury and improving the chances of survival when involved in a serious accident. Furthermore, properly worn seat belts improve the protection provided by airbags in the event of an accident. For this reason, wearing a seat belt is required by law in most countries.

Although your vehicle is equipped with airbags, the seat belts must be fastened and worn. The front airbags, for example, are only triggered in some cases of head-on collision. The front airbags will not be triggered during

minor frontal or side collisions, rear-end collisions, rollovers or accidents in which the airbag trigger threshold value in the control unit is not exceeded.

Therefore, you should always wear your seat belt and ensure that all vehicle occupants have fastened their seat belts properly before you drive off!

Head-on collisions and the laws of physics

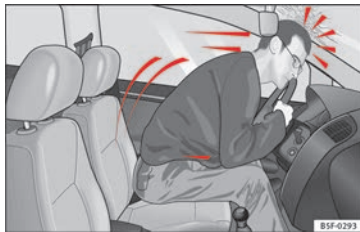


Fig. 84 A driver not wearing a seat belt is thrown forward violently.



Fig. 85 The unbelted rear passenger is thrown forward violently, hitting the driver wearing a seat belt

It is easy to explain how the laws of physics work in the case of a head-on collision: when a vehicle starts moving, a type of energy called "kinetic energy" is created both in the passengers and inside the vehicle.

The amount of "kinetic energy" depends on the speed of the vehicle and on the weight of the vehicle and of its passengers. The higher the speed and the greater the weight, the more energy there is to be "absorbed" in an accident.

The most significant factor, however, is the speed of the vehicle. If the speed doubles from 25 km/h (15 mph) to 50 km/h (30 mph), for example, the corresponding kinetic energy is multiplied by four.

Because the vehicle occupants in our example are not restrained by seat belts, in the

event of crashing against a wall, all of the occupants' kinetic energy will be absorbed solely by said impact.

Even at speeds of 30 km/h (19 mph) to 50 km/h (30 mph), the forces acting on bodies in a collision can easily exceed one tonne (1000 kg). At greater speed these forces are even higher.

Vehicle occupants not wearing seat belts are not "attached" to the vehicle. In a head-on collision, they will move forward at the same speed their vehicle was travelling just before the impact. This example applies not only to head-on collisions, but to all accidents and collisions.

Even at low speeds the forces acting on the body in a collision are so great that it is not possible to brace oneself with one's hands. In a frontal collision, unbelted passengers are thrown forward and will make violent contact with the steering wheel, dash panel, windscreen or whatever else is in the way »» Fig. 84.

It is also important for rear passengers to wear seat belts properly, as they could otherwise be thrown forward violently through the vehicle interior in an accident. Passengers in the rear seats who do not use seat belts endanger not only themselves but also the front occupants »» Fig. 85.

Using seat belts

Twisted seat belt

If it is difficult to remove the seat belt from the guide, the seat belt may have become twisted inside the side trim after being wound too quickly on unfastening:

- Pull out the seat belt completely, carefully pulling on the latch plate.
- Untwist the belt and guide it back, assisting it by hand.

The seat belt must be fastened even if it is impossible to untwist it. In this case, the twisted area must not be in an area in direct contact with your body. Have the seat belt untwisted urgently by a specialised workshop.

WARNING

An improperly handled seat belt increases the risk of sustaining severe or fatal injuries.

- Regularly check that the seat belts and their components are in perfect condition.
- Always keep your seat belt clean.
- Do not jam or damage the seat belt or rub it with sharp edges.
- Make sure there are no liquids or foreign bodies on the latch plate and in the buckle.

How to properly adjust your seatbelt

Fastening and unfastening your seat belt

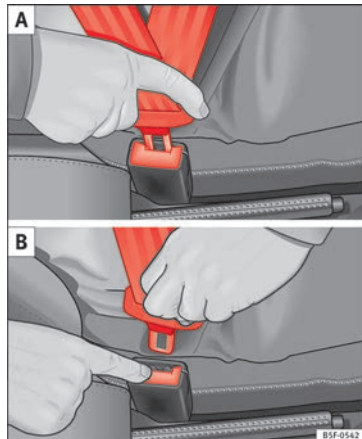


Fig. 86 Insert the latch plate into the buckle »»



Fig. 87 Position of seat belt during pregnancy.

Properly worn seat belts hold the vehicle occupants in the position that most protects them in the event of an accident or sudden braking » » » **△**.

Fastening the seat belt

Fasten your seat belt before each trip.

- Adjust the front seat and head restraint correctly » » » page 58.
- Engage the seat backrest of the rear seat in an upright position » » » **△**.
- Pull the latch plate and place the belt webbing evenly across your chest and lap. Do **not** twist the seat belt when doing so » » » **△**.
- Engage the latch plate in the buckle of the corresponding seat » » » **Fig. 86 A**.

- Pull the belt to ensure that the latch plate is securely engaged in the buckle.

Unfastening the seat belt

The seat belt must not be unfastened until the vehicle has come to a standstill » » » **△**.

- Press the red button on the buckle » » » **Fig. 86 B**. The latch plate is released from the buckle.
- Guide the belt back by hand so that it rolls up easily and the trim will not be damaged.

Correct belt position

Seat belts offer their maximum protection in the event of an accident and reduce the risk of sustaining severe or fatal injuries only when they are properly positioned. Furthermore, if the webbing is correctly positioned, the seat belt will hold the vehicle occupants in the optimum position to ensure the airbag provides the maximum protection. The seat belt must therefore always be worn and the webbing correctly positioned.

Incorrectly worn seat belts can cause severe or even fatal injuries » » » page 58, **Correct position of the vehicle occupants**.

- The shoulder part of the seat belt must lie on the centre of the shoulder, never across the neck or the arm, under the arm or behind the shoulder.

- The lap part of the seat belt must lie across the pelvis, never across the stomach.
- The seat belt must lie flat and fit comfortably. Pull the belt tight if necessary to take up any slack.

In the case of **pregnant women**, the seat belt must lie evenly across the chest and as low as possible over the pelvis, never across the stomach and must be worn properly at all times during the pregnancy » » » **Fig. 87**.

Adapting the position of the belt webbing to your size

The seat belt can be adapted using the following equipment:

- Belt height adjustment for the front seats.
- Front seat height adjustment.

△ WARNING

An incorrectly worn seat belt web can cause severe or fatal injuries in the event of an accident.

- **The seat belt cannot offer its full protection unless the seat backrest is in an upright position and the seat belt is worn correctly, according to your size.**
- **Unbuckling your seat belt while the vehicle is in motion can cause severe or fatal injuries in the event of an accident or sudden braking.**

- The seat belt itself, or a loose seat belt, can cause severe injuries if the belt moves from hard areas of the body to soft areas (e.g. the stomach).
- The shoulder part of the seat belt must lie on the centre of the shoulder, never across the neck or the arm.
- The seat belt must lie flat and fit comfortably on the torso
- The lap part of the seat belt must lie across the pelvis, never across the stomach. The seat belt must lie flat and fit comfortably on the pelvis. Pull the belt tight if necessary to take up any slack.
- For pregnant women, the lap part of the seat belt must lie as low as possible over the pelvis and always lie flat, "surrounding" the stomach » Fig. 87.
- Do not twist the seat belt while it is fastened.
- Once the seat belt is positioned correctly, don't pull it away from your body with your hand.
- Do not lie the seat belt across rigid or fragile objects, e.g. glasses, pens or keys.
- Never use seat belt clips, retaining rings or similar instruments to alter the position of the belt webbing.

i Note

If your physical constitution prevents you from maintaining the correct position of the

belt webbing, contact a specialised workshop for help with any special devices to ensure the optimum protection of the seat belt and airbag. SEAT recommends taking your car in for technical service.

Fastening or unfastening the seat belt with two buckles

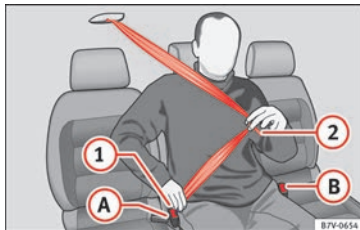


Fig. 88 Fasten the seat belt on the centre seat in the second row of seats

Properly worn seat belts hold the vehicle occupants in the position that most protects them in the event of an accident or sudden braking » Δ .

The seat belts for the centre seat in the second row of seats and for the seats in the third row of seats are fastened using two buckles.

Fastening the seat belt

Fasten your seat belt before each trip.

- Adjust the rear seat and head restraint correctly » page 58.
- Engage the seat backrest of the rear seat in an upright position » Δ .
- Use latch plate of the belt » Fig. 88 ① to pull the seat belt down. Do **not** twist the seat belt when doing so » Δ .
- Engage the latch plate ① in the buckle of the corresponding seat **A**.
- Use the latch plate » Fig. 88 ② to pull the seat belt across your lap.
- Engage the latch plate ② in the buckle of the corresponding seat **B**.
- Pull the belt to ensure that **both** latch plates are securely engaged in the buckles.

Unfastening the seat belt

The seat belt must not be unfastened until the vehicle has come to a standstill » Δ .

- Press the red button on the buckle » Fig. 88 **A**. The latch plate is released from the buckle.
- Press the red button on the buckle » Fig. 88 **B**. The latch plate is released from the buckle.
- Guide the belt back by hand so that it rolls up easily and the trim will not be damaged. »

⚠ WARNING

An incorrectly worn seat belt web can cause severe or fatal injuries in the event of an accident.

- The seat belt cannot offer its full protection unless the seat backrests are in an upright position and the seat belt is worn correctly, according to your size.
- Unbuckling your seat belt while the vehicle is in motion can cause severe or fatal injuries in the event of an accident or sudden braking.

i Note

Seat belts with two buckles include a diagram to show how to fasten the seat belt.

Belt height adjustment

Fig. 89 Next to the front seats: belt height adjuster

Using the height adjusters for the front seats and the outer seats of the second row, the position of the seat belts can be adjusted in the shoulder area according to the height of the occupant:

- Keep the guide device pressed down in the direction of the arrow » **Fig. 89**.
- Move the guide device up or down until the seat belt lies over the centre of your shoulder » **page 65**.
- Release the guide device.
- Pull the belt sharply to check that the device is engaged securely.

⚠ WARNING

Never adjust the belt height while the vehicle is in motion.

Seat belt tensioners**Automatic belt retractor, belt tensioner, belt tension limiter**

Seat belts are part of the vehicle's safety features and consist of the following important functions:

Automatic belt retainer

Every seat belt is equipped with an automatic belt retainer on the shoulder belt. If the belt

is pulled slowly or during normal driving, the system allows for total freedom of movement on the shoulder belt. However, during sudden braking, during travel in mountains or bends and during acceleration, the automatic belt retainer on the seat belt is locked is pulled quickly.

Belt tensioners

The seat belts on the front seats and the outer seats of the second row are equipped with belt tensioners.

Sensors trigger the belt tensioners during severe head-on, lateral and rear collisions and retract and tighten the seat belts. If the seat belt is loose, it is retracted to reduce the forwards movement of vehicle occupants or movement in the direction of the collision. The belt tensioner works in combination with the airbag system. The belt tensioner will not be triggered in the event of the vehicle overturning if the side airbags are not deployed.

If the belt tensioner is triggered, a fine dust is produced. This is normal and it is not an indication of fire in the vehicle.

Belt tension limiter

The belt tension limiter reduces the force of the seat belt on the body in the event of an accident.

Note

The relevant safety requirements must be observed when the vehicle is dismantled or system components are removed. These requirements are known to specialised workshops »» page 69.

Service and disposal of belt tension devices

If you work on the belt tensioners or remove and install other parts of the vehicle when performing other repair work, the seat belt may be damaged. The consequence may be that, in the event of an accident, the belt tensioners function incorrectly or not at all.

So that the effectiveness of the belt tensioner is not reduced and that removed parts do not cause any injuries or environmental pollution, regulations must be observed. These requirements are known to specialised workshops.

WARNING

Improper handling and homemade repairs of seat belts, automatic belt retainers and tension devices increase the risk of sustaining severe or fatal injuries. The belt tensioner may fail to trigger or may trigger in the wrong circumstances.

- Never attempt to repair, adjust or remove or install parts of the belt tensioners or seat belts. Any work must be performed by a specialised workshop only »» page 247.
- Belt tensioners and automatic belt retainers cannot be repaired and must be replaced.

For the sake of the environment

Airbag modules and belt tensioners may contain perchlorate. Observe the legal requirements for their disposal.

Airbag system

Brief introduction

Introduction

Front airbags have been installed for both driver and passenger. The front airbags can also protect the chest and head of driver and passenger if the seats, seat belts head restraints and, for the driver, the steering wheel are correctly adjusted and used. Airbags are considered as additional safety equipment. An airbag cannot replace the seat belt, which must be worn at all times, even in front seats where front airbags have been installed.

WARNING

Never exclusively trust the airbag system as a means of protection.

- Even when triggered, airbag protection is only auxiliary.
- The airbags provide the best protection when the seat belts are properly fastened, thus reducing the risk of sustaining injuries »» page 65, How to properly adjust your seat belt.
- Before each trip, every occupant must sit properly, correctly fasten the seat belt belonging to his or her seat and keeping it fastened throughout the trip. This rule is valid for all vehicle occupants.

⚠ WARNING

Vehicle occupants sitting in the front of the vehicle must never carry any objects in the deployment space between them and the airbags, as this increases the risk of sustaining injuries if the airbag is triggered. This modifies the airbag deployment space or the objects may fly uncontrollably and hit your body.

- Never carry objects in your hand or on your lap while the vehicle is in motion.
- Never transport objects on the front passenger seat. In the event of sudden braking and manoeuvres, the objects may end up in the airbag deployment space and fly uncontrollably around the vehicle interior if the airbag is activated.
- Vehicle occupants of the front and outer rear seats must never carry any other people, pets or objects in the deployment space between them and the airbags. Make sure children and other passengers also respect this recommendation.

⚠ WARNING

The airbag system provides protection for one accident only. If they have been deployed, they must be replaced.

- Ensure deployed airbags and the system components involved are immediately replaced with new, SEAT-approved components for the vehicle.

- Have any repairs or modifications carried out at a specialised workshop. Specialised workshops have the necessary tools, diagnostics equipment, repair information and qualified personnel.

- Never fit recycled or reused airbag components in your vehicle.
- Never modify the airbag system components.

⚠ WARNING

If the airbags are triggered, a fine dust is produced. This is normal and it is not an indication of fire in the vehicle.

- This fine dust may irritate the skin and eyes and cause breathing difficulties, particularly in people suffering from or who have suffered from asthma or other illnesses of the respiratory tract. To reduce breathing difficulties, get out of the vehicle and open and doors and windows to breath in fresh air.
- Should you touch the dust, wash your hands and face using a mild soap and water before you eat.
- Prevent the dust from affecting the eyes or open wounds.
- Rinse your eyes with water if you have dust in them.

⚠ WARNING

Solvents cause the surfaces of the airbag modules to become porous. If an airbag is ac-


cidental triggered, the detachment of plastic parts could cause serious injury.

- Never clean the dash panel and the surfaces of the airbag modules with cleaners containing solvents.


Description of the airbag system

The airbag system is not a substitute for the seat belts. The airbag system offers additional protection for the driver and passenger in combination with the seat belts.

The airbag system comprises the following modules (as per vehicle equipment):

- Electronic control unit.
- Front airbags for driver and passenger
- Knee airbag for the driver
- Side airbags
- Head airbag
- Airbag control lamp  on the instrument panel
- Key-operated switch for front passenger airbag
- Control lamp to disconnect/connect the front airbag.

The airbag system operation is monitored electronically. The airbag control lamp will illuminate for a few seconds every time the ignition is switched on (self-diagnosis).

There is a fault in the system if the  control lamp:

- does not light up when the ignition is switched on,
- turns off after 4 seconds after the ignition is switched on,
- turns off and then lights up again after the ignition is switched on,
- illuminates or flashes while the vehicle is moving.

The airbag system is not triggered if:

- the ignition is switched off
- there is a minor frontal collision
- there is a minor side collision
- there is a rear-end collision
- the vehicle turns over.

WARNING

- **The seat belts and airbags can only provide maximum protection if the occupants are seated correctly» page 58.**
- **If a fault has occurred in the airbag system, have the system checked immediately by a specialised workshop. Otherwise there is a**

danger that during a collision, the system may fail to trigger, or not trigger correctly.

Airbag activation

The airbags deploy extremely rapidly, within thousandths of a second, to provide additional protection in the event of an accident.

The airbag system is only ready to function when the ignition is on.

In special accidents instances, several airbags may activate at the same time.

In the event of minor head-on and side collisions, rear-end collisions, overturning or roll-over of the vehicle, airbags **do not activate**.

Activation factors

The conditions that lead to the airbag system activating in each situation cannot be generalised. Some factors play an important role, such as the properties of the object the vehicle hits (hard/soft), angle of impact, vehicle speed, etc.

Deceleration trajectory is key for airbag activation.

The control unit analyses the collision trajectory and activates the respective restraint system.

If the deceleration rate is below the predefined reference value in the control unit the

airbags will not be triggered, even though the accident may cause extensive damage to the car.

The following airbags are triggered in serious head-on collisions:

- Driver airbag.
- Front passenger front airbag
- Knee airbag for the driver.

The following airbags are triggered in serious side-on collisions:


- Front side airbag on the side of the accident.
- Rear side airbag on the side of the accident.
- Curtain (head) airbag on the side of the accident.

In an accident with airbag activation:

- the interior lights switch on (if the interior light switch is in the courtesy light position);
- the hazard warning lights switch on;
- all doors are unlocked;
- the fuel supply to the engine is cut.

Airbag safety instructions

Front airbags



Read the additional information carefully
»  page 19.

WARNING

The airbag is deployed at high speed in fractions of a second.


- Always keep the deployment areas of the front airbags free.
- Never secure objects to the covers or in the deployment area of the airbag modules, e.g. drink holders or phone supports.
- The deployment space between the front passengers and the airbags must not in any case be occupied by other passenger, pets and objects.
- Never fix any object to the windscreen above the front airbag on the front passenger side.
- Do not alter, cover or stick anything to the steering wheel hub or the surface of the airbag module on the passenger side of the dash panel.

WARNING

Front airbags are deployed in front of the steering wheel »  Fig. 25 and the dash panel »  Fig. 26.

- When driving, always hold the steering wheel on the outer edge of the ring with both hands: 9 o'clock and 3 o'clock position.
- Adjust the driver seat so that there is at least 25 cm distance between your chest and the hub of the steering wheel. If your physical constitution prevents you from meeting these requirements, make sure you contact a specialised workshop.
- Adjust the front passenger seat so there is as much distance as possible between the front passenger and the dash panel.

Knee airbag*


Read the additional information carefully
»  page 20.

WARNING

The airbag is deployed at high speed in fractions of a second.

- The knee airbag is deployed in front of the driver's knees. Always keep the deployment areas of the knee airbags free.
- Never not fix objects to the cover or in the deployment area of the knee airbag.
- Adjust the driver seat so that there is a distance of at least 10 cm (4 inches) between your knees and the location of the knee airbag. If your physical constitution prevents you from meeting these requirements, make sure you contact a specialised workshop.

Side airbags*

Read the additional information carefully
»  page 21.

WARNING

The airbag is deployed at high speed in fractions of a second.

- Always keep the deployment areas of the side airbags free.
- Vehicle occupants of the front and outer rear seats must never carry any other people, pets or objects in the deployment space between them and the airbags.
- The built-in coat hooks should be used only for lightweight clothing. Do not leave any heavy or sharp-edged objects in the pockets.
- Do not mount accessories on the doors.
- Only used protective covers for the seats that are approved for the vehicle. Otherwise, the side airbag would be obstructed when deployed.


WARNING

Incorrect handling of the driver's and front passenger seat could prevent the side airbag from deploying properly and cause severe injuries.

- Never remove the front seats of the vehicle or modify any of their components.

- Great forces must not be exerted on the seat backrest bolsters because the side airbags might not deploy correctly, might not deploy at all or might deploy unexpectedly.
- Any damage to the original seat upholstery or around the seams of the side airbag units must be repaired immediately by a specialised workshop.

Curtain airbags*

Read the additional information carefully
»»  page 21.

WARNING

The airbag is deployed at high speed in fractions of a second.

- Always keep the deployment areas of the head-protection airbags free.
- Do not fix objects to the cover or in the deployment area of the curtain airbag.
- Vehicle occupants of the front and outer rear seats must never carry any other people, pets or objects in the deployment space between them and the airbags.
- The built-in coat hooks should be used only for lightweight clothing. Do not leave any heavy or sharp-edged objects in the pockets.
- Do not mount accessories on the doors.

- Do not fit curtains to the windows other than those expressly approved for use in the vehicle.
- Only turn the sun blinds towards the windows if there is no object, e.g. pens or garage remote controls, secured to the sun blind.

Deactivating airbags

Control lamp

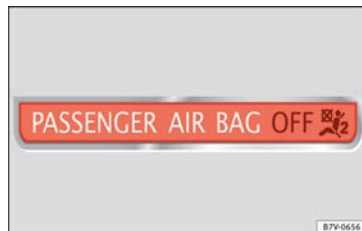







Fig. 90 Control lamp for disabling the front passenger front airbag on the dash panel

	It lights up on the combi-instrument
Fault in airbag system and seat belt tensioners.	Have the system checked immediately by a specialised workshop.

OFF 	It lights up on the dash panel
Fault in the airbag system.	Have the system checked immediately by a specialised workshop.
Front passenger front airbag disabled.	Check whether the airbag should remain disabled

Several warning and control lamps light up for a few seconds when the ignition is switched on, signalling that the function is being verified. They will switch off after a few seconds.

If the front passenger airbag is deactivated, the lamp **PASSENGER AIR BAG OFF**  **does not remain lit**, or if it is lit together with the control lamp  on the instrument panel, there may be a fault in the airbag system »» .

WARNING

In the event of a fault in the airbag system, the airbag may not trigger correctly, may fail to trigger or may even trigger unexpectedly, leading to severe or fatal injuries.

- Have the airbag system checked immediately by a specialised workshop.
- Never mount a child seat in the front passenger seat »» page 79 or remove the mounted child seat! The front passenger front airbag may deploy during an accident in spite of the fault.


ⓘ CAUTION

Always pay attention to any lit control lamps and to the corresponding descriptions and instructions to avoid damage to the vehicle.

Manual disabling and enabling of the front passenger front airbag with the key switch




Fig. 91 In the glove compartment on the front passenger side: Key switch for enabling and disabling the front passenger front airbag.

Read the additional information carefully
»»  page 20.



The front passenger front airbag must be disabled when a rear-facing child seat is mounted.



Activating the front passenger front airbag

- Switch the ignition off.

- Open the glove compartment on the front passenger side.
- Insert the key into the slot of the switch for deactivating the front passenger airbag
»» **Fig. 91**. About 3/4 of the key should enter, as far as it will go.
- Then turn the key gently to the **ON** position. Do not force it if you feel resistance, and make sure you have inserted the key fully.
- Close the glove compartment on the front passenger side.
- Check that, with the ignition switched on, the control lamp **PASSENGER AIR BAG OFF**  on the dash panel is *not* lit »» page 73.

How to know whether the front passenger front airbag is disabled

The **only** indication of the front passenger airbag being disabled is that the **PASSENGER AIR BAG OFF**  control lamp on the dash panel remains lit (**OFF**  stays yellow) »» page 73, **Control lamp**.

If the **PASSENGER AIR BAG OFF**  control lamp on the centre console **does not remain lit** or is lit in combination with the control lamp  on the dash panel, a child restraint system cannot be mounted on the front passenger seat for safety reasons. The front passenger front airbag may deploy during an accident.

⚠ WARNING

The front passenger front airbag must only be disabled in special cases.

- **Disable and activate the front passenger front airbag when the ignition is switched off to avoid damage to the airbag system.**
- **It is the driver's responsibility to ensure that the key operated switch is set to the correct position.**
- **Only disable the front passenger front airbag when a child seat is to be mounted under exceptional circumstances.**
- **As soon as the child seat is no longer needed on the front passenger seat, reconnect the front passenger front airbag.**
- **Never leave the key in the airbag deactivation switch as it could get damaged or activate or deactivate the airbag during driving.**

Transporting children safely

Safety for children

Introduction

Read the additional information carefully

»  page 22.

Please read the information regarding the airbag system fully before transporting babies and children in a child seat or other child restraint system installed on the front passenger seat.

This information is extremely important for driver and passenger safety, particularly that of babies and children.

SEAT recommends the use of child seats from the SEAT accessory programme. These child seats have been designed and tested for use in SEAT vehicles. You can purchase child seats with different mountings from a technical service centre.

Using child restraint systems with a base or foot

Some child retention systems are secured to the seat using a base or support leg. For certain kinds of equipment the use of an additional accessory will be necessary (e.g. an accessory for the footwell) to fit the child retention system correctly and securely.

WARNING

Make sure children are properly belted in and correctly secured to avoid severe or fatal injuries while the vehicle is in motion.

- If a child seat is secured to the front passenger seat, the risk to the child of sustaining critical or fatal injuries in the event of an accident increases.
- An inflating front passenger airbag can strike the rear-facing child seat and project it with great force against the door, the roof or the backrest.
- Never install a child seat facing backwards on the front passenger seat unless the front passenger front airbag has been disabled. Risk of potentially fatal injuries to the child! However, if it is necessary, in exceptional cases, to transport a child in the front passenger seat, the front passenger front airbag must always be disabled » page 73. If the passenger seat has a height adjustment option, move it to the highest, most upright position. If you have a fixed seat, do not install any child restraint system in this location.
- For those vehicles that do not include a key lock switch to deactivate the airbag, the vehicle must be taken to a technical service.
- Children up to 12 years old should always travel on the rear seat.
- Children must always be protected with an approved child restraint system suited to their height and weight.

- Children must assume the proper sitting position and be properly belted in while travelling.
- Ensure the seat backrest is upright when a child seat is being used on it.
- Do not allow the child's head or other part of his or her body to fall into the deployment area of the side airbags.
- Make sure the belt webbing is correctly positioned.
- Never hold children or babies on your lap or in your arms.
- Only one child may occupy a child seat.
- If you are using a child seat with a base or foot, always install this base or foot correctly and safely.
- If the vehicle has a storage compartment in the footwell in front of the last row of seats, this compartment cannot be used as designed; on the contrary: It must be filled using the specially designed accessory so that the base or foot is correctly supported by the closed compartment and the child seat is secured properly. If this compartment is not suitably secured when using a child seat with a base or foot then the compartment cover could rupture in an accident and the child will be ejected and suffer serious injury.
- Please read and observe the child seat manufacturer's handling instructions.

»

⚠ WARNING


An empty or loose child seat could fly uncontrollably around the vehicle interior and cause injuries in the event of an accident or sudden braking.

- When not in use while the vehicle is in motion, always safely secure the child seat or store it in the luggage compartment.



i Note

Replace the child seat after an accident, as it may have invisible damage.


Important information regarding the front passenger's airbag

Read the additional information carefully
»  page 22.

Read and always observe the safety information included in the following chapters:

- Child seats and passenger side airbag
» page 77, Use of the child seat on the front passenger seat.
- Safety distance with respect to the passenger airbag »  in Introduction on page 69.
- Objects between the passenger and the passenger side airbag »  in Front airbags on page 72.

Child seats**Safety instructions**

Read the additional information carefully
»  page 22.

⚠ WARNING

The lower anchor points for child seats are not anchors meant to support cargo. Only secure booster seats to lower anchor points.

⚠ WARNING

Child seats with lower anchor points and with an upper retaining strap must be installed in line with the manufacturer's instructions. Failure to comply could result in severe injuries.

- Always secure just *one* retaining strap from a child seat to a retaining ring (for Top Tether) on the seat backrest on the rear seat in the boot.
- Never fix child seats to the cargo anchors in the luggage compartment.
- Never secure a child seat to the movable attachment elements for vehicles *with an attachment element and rail system*.

⚠ WARNING

In general, the rear seat is always the safest place for correctly belted in children in the event of an accident.

- A suitable child seat that is correctly installed and used on one of the rear seats offer the most protection possible for babies and small children in most accidents.

⚠ WARNING


Unbuckling the seat belt while the vehicle is in motion can cause severe or fatal injuries in the event of an accident or sudden braking.

- The seat belt must not be unfastened until the vehicle has come to a standstill.

i Note

Other accessories may be required to fit the child retention system with a base or foot security and safely. Contact a technical service centre or specialised workshop.

General information on transporting children in the vehicle

Read the additional information carefully
»  page 23.

Legal regulations and provisions will always take priority over the descriptions of this instruction manual. There are different regulations and provisions for the use of child seats and their mountings (» table on page 77). In some countries, for example, the use of child seats on certain seats in the vehicle may be forbidden.

The physical principles and the forces acting on the vehicle in the event of a collision or other type of accidents also apply to children » page 65. However, unlike adults and youngsters, children do not have fully developed muscle and bone structures. In the event of an accident, children are subject to a greater risk than adults of sustaining severe injuries.

Given that children's bodies are not yet fully developed, child restraint systems must be used that are especially adapted to their height, weight and constitution. There are laws in force in many countries that indicate the use of approved seat systems for transporting babies and children.

Only used authorised, approved child seats that are suitable for the vehicle. Always consult with a technical service centre or a specialised workshop should you have any doubts.

Specific child seat regulations for each country (selection)

Regulation	Further information
ECE-R 44 ^{a)}	technical service centre

^{a)} ECE-R: Economic Commission for Europe Regulation.

¹⁾ Compliance with current national legislation and the manufacturer's instructions is required when using or installing child seats.

Categorisation of child seats according to ECE-R44

Weight category	Weight of the child	Installation of the child seat
Group 0	up to 10 kg	Rear-facing. On rear seats, optionally using the ISOFIX system.
Group 0+	up to 13 kg	
Group 1	9 to 18 kg	Forward-facing. On rear seats, optionally using the ISOFIX system.
Group 2	15 to 25 kg	Forward-facing. On the outer rear seats or in the centre seat of the second row of seats and on all seats in the third row. Optionally with ISOFIX system.
Group 3	22 to 36 kg	Forward-facing.

Not all children fit in the seat of their weight group. Nor do all seats adapt to the vehicle. Therefore, always check whether the child fits properly in the child seat and whether the seat can be installed safely in the vehicle.

The rear seats are suitable for child seats with the **ISOFIX system** specially designed for this type of vehicle in accordance with regulation ECE-R 44.



Child seats approved under the ECE-R 44 regulation are fitted with the corresponding approval symbol. The sign is an upper-case E in a circle with the identification number below it.

Use of the child seat on the front passenger seat¹⁾


Transporting children on the front passenger seat is not permitted in all countries. Furthermore, not all child seats are approved for use on the front passenger seat. Your technical service centre has an updated list of all approved child seats. Only used child seats that are approved for each vehicle.

The front airbag on the front passenger side is highly dangerous for a child. The front passenger seat is life-threatening to a child if he or she is transported in a rear-facing child seat.

If a rear-facing child seat is secured to the front passenger seat, an inflating front airbag can strike it with such great force that severe or fatal injuries may result » » ». Therefore, rear-facing child seats must **never** be placed on the front passenger seat when the front passenger front airbag is enabled. »

Only use a rear-facing child seat on the front passenger seat if the front passenger front airbag is disabled. When it is disabled, the yellow control lamp on the dash panel **PASSENGER AIR BAG OFF**  will be lit up » page 73. **If you cannot disable the front passenger front airbag and it remains activated, it is forbidden to transport children on the front passenger seat** » .

Things to note if using a child seat on the front passenger seat:

- The front passenger front airbag **must** be disabled  when using a rear-facing child seat » page 74.
- The seat backrest of the front passenger seat must be upright.
- The front passenger seat must be moved as far back as possible.
- A height-adjustable front passenger seat must be raised to its highest point.
- The seat belt height adjustment must be as high as possible.

Suitable child seats

The child seat must be authorised by the manufacturer especially for use on a front passenger seat with a front or side airbag.

If the front passenger seat is equipped with **retaining rings**, the child seat can be secured using an approved retaining system provided it is approved for this type of vehicle in ac-

cordance with current regulations of the country in question.

Universal seats for children of groups 0, 0+, 1, 2 or 3 according to the standard ECE-R 44 can be mounted on the front passenger seat and the rear seats.

WARNING

If a child seat is mounted on the front passenger seat, the risk of the child sustaining severe or fatal injuries in the event of an accident increases. Rear-facing child seats must never be mounted on the front passenger seat when the front passenger front airbag is enabled. This is life-threatening to the child should the front airbag deploy, as the child seat would be struck by the inflated airbag and thrown against the seat backrest.


WARNING

If, in exceptional circumstances, a child must be transported in a rear-facing child seat on the front passenger seat, strictly observe the following:

- Always disable the front passenger front airbag and leave it disabled.
- The child seat must be approved by the manufacturer for use on a front passenger seat with front and side airbag.
- Follow the installation instructions of the child seat manufacturer and observe the warnings.

- Move the front passenger seat as far back as possible and adjust it to its highest position to keep as far away as possible from the front airbag.
- Move the seat backrest to the upright position.
- The seat belt height adjustment must be as high as possible.
- Children must always be protected with an approved child restraint system suited to their height and weight.

Use of the child seat on the rear seat

If a child seat is mounted on the rear seat, adapt the position of the front passenger seat so that the child has enough space. Therefore, adapt the front passenger seat to the size of the child seat and the height of the child. Ensure the passenger is in the correct position  » page 58.

Move the second and third rows of seats fully back and lock them. Place the seat backs in a vertical position and fold the head restraints down.

ISOFIX child seats approved for rear seats

The rear seats are suitable for child seats with the **ISOFIX system** specially designed for this type of vehicle in accordance with regulation ECE-R 44.

ISOFIX child seats are divided into “specific categories for the vehicle”, “limited” or “semi-universal”.

Child seat manufacturers supply a list of vehicles with each ISOFIX seat, which includes the models for which the ISOFIX child seat in question is approved. If the vehicle is included in the manufacturer’s list and the ISOFIX child seat belongs to a seat category included in the list, then it can be used in your vehicle. If necessary, contact the child seat manufacturer for an updated list of vehicles.

Group (weight category)	ISOFIX child seat category	Seat position in the rear seats
Group 0: to 10 kg	E	IUF ^{a)}
	E	IUF ^{a)}
Group 0+: to 13 kg	D	IUF ^{a)}
	C	IUF ^{a)}
Group 1: 9 to 18 kg	D	IUF ^{a)}
	C	IUF ^{a)}
	B	IUF ^{a)}
	B1	IUF ^{a)}
	A	IUF ^{a)}

^{a)} IUF: suitable for “universal” ISOFIX child seats authorised for use in this group.

WARNING

If child seats are fitted to all the seats in the second row then it is possible that the seats of this row cannot be folded down from the third row of seats in case of an accident. In the event of an emergency, passengers in the third row of seats will not be able to leave the vehicle or to help themselves.

- Child seats should never occupy all the seats of the second row if other passengers are to occupy the third row of seats.

Integrated child seat

Introduction

The integrated child seat is only suitable for children in Group 2 (15-25 kg) and Group 3 (22-36 kg), according to the ECE-R44 regulation.

WARNING

Child travelling without their seat belt fastened or not secured using a suitable restraint system may sustain fatal injuries if the airbag is deployed.

- Children up to 12 years old should always travel on the rear seat.
- Always disable the front passenger front airbag if, in exceptional cases, you have no alternative but to transport a child in a rear-

facing child safety seat on the front passenger seat.

- Children must always be protected with a child restraint system suited to their height and weight.
- Always fasten children's seat belts correctly.

WARNING

Children must travel in a child seat appropriate to their weight and height while the vehicle is in motion.

- Children must always be protected with a child restraint system suited to their height and weight.
- Children must assume the proper sitting position and be properly belted in while travelling.
- The shoulder part of the seat belt must lie approximately on the centre of the shoulder, never across the neck or the arm.
- The seat belt must lie close to the upper part of the body.
- The lap belt part must lie across the pelvis, not across the stomach, and always fit closely.
- Allow the belt to retract until it fits tightly over the child's seat.
- Never hold children or babies on your lap.

- Always use a child seat and the seat belt for children who are under 1.5 m tall. The *normal* seat belt could cause injuries to the abdominal and neck areas.
- Only one child may occupy a child seat.
- Read and follow the information and warnings provided by the child seat manufacturer.
- Never leave an unsupervised child alone on a child seat or in the vehicle.
- All modifications to the integrated child seat must be carried out by a specialised workshop.
- Replace the child seat or any seat components damaged or involved in an accident.

⚠ WARNING

Loose objects could fly uncontrollably around the vehicle interior and cause injuries in the event of an accident or sudden braking.

- Do not leave toys or other hard, loose objects on the child seat or on the seat while the vehicle is in motion.

Unfolding the integrated child seat

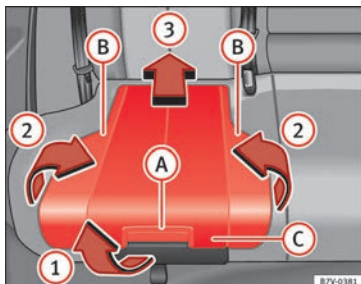


Fig. 92 Integrated child seats. lift up the cushion

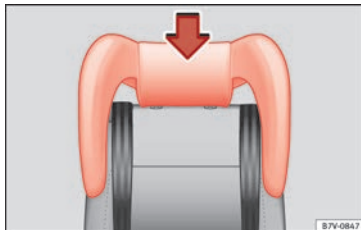


Fig. 93 Integrated child seats. install its head support.

Lifting the cushion

- Pull the unlock lever **»» Fig. 92 (A)** on the cushion in the direction of the arrow **»» Fig. 92 (1)**.
- Fold both sides **»» Fig. 92 (B)** up in the direction of the arrow **»» Fig. 92 (2)**.
- Push the cushion **»» Fig. 92 (C)** back in the direction of the arrow **»» Fig. 92 (3)** until it engages.

Install the head restraint on the child safety seat

- Remove the head support and store it safely in the vehicle **»» page 143**.
- Make sure that the seat belt guide is installed in the head support of the seat for children on the window side **»» page 81**.
- Enter the child seat head support in the corresponding backrest until it fits correctly into place **»» Fig. 93**.
- Make sure that the rear seats and backrests are correctly locked into place, pulling on both of them.

Seat belt routing on the integrated child seat

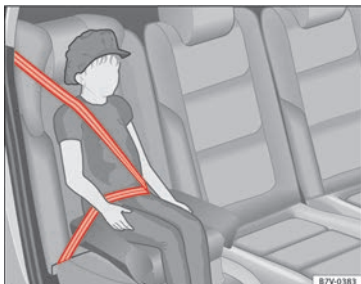


Fig. 94 Integrated child seats. adjusting the seat belt.



Fig. 95 Integrated child seats. seat belt routing with guide handle

Using the guide handle » **Fig. 95**, position the seat belt so that the shoulder part of the belt lies on the centre of the child's shoulder.

Seat belt guide handle

- Secure the seat belt guide handle to the side head restraint on the window side. The guide handle is secured by a button.
- Open the upper button on the seat belt guide handle and pass the belt webbing below the side head restraint and through the guide handle.
- Close the button again.

Adjusting the seat belt

- Guide the automatic three-point seat belt below the side head restraint.
- Pull the latch plate and slowly place the belt webbing across the child's chest and lap.
- Insert the latch plate into the buckle for the appropriate seat and push it down until it is securely locked with an audible click.
- Pull the belt to ensure that the latch plate is securely engaged in the buckle.

⚠ WARNING

The seat belt only offers maximum protection from severe or fatal injuries when it is correctly positioned.

- Children must assume the proper sitting position and be properly belted in while travelling.
- The shoulder belt must be positioned against the middle of the shoulder.
- The seat belt must lie flat and fit comfortably.
- Allow the belt to retract until it fits tightly over the child's seat.
- The lap part of the seat belt must lie across the pelvis, never across the stomach.
- Only one child may occupy a child seat.

Removing the child seat

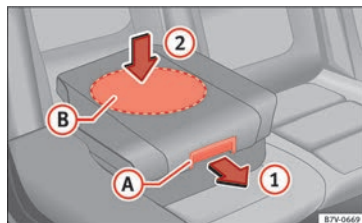


Fig. 96 Integrated child seats. lowering the cushion

Lowering the cushion

- Pull the unlock lever » **Fig. 96** **A** on the cushion in the direction of the arrow **1**.

- Push the cushion down through the central area **Ⓑ** in the direction of the arrow **②** until it safely engages **»»** **Ⓐ**. The side supports fold away automatically.

Remove the head restraint on the child safety seat

- Open the guide lever on the seat belt and guide it by hand to pull the belt back in more easily and without damaging the trim.
- Lift the child seat head restraint to the top.
- Fold the backrest of the rear seat forwards **»»** page 147.
- Remove the head restraint on the child safety seat.
- Fitting the head restraint.

ⓘ CAUTION

When lowering the integrated child seat, only press on the centre of the cushion **»» Fig. 96 **②**. Otherwise the cushion could bend and not engage properly.**

Emergencies

Self-help

In case of emergency

First aid kit, warning triangle, reflective vests and fire extinguishers*



Fig. 97 On the rear lid: Warning triangle bracket

Reflective vests

Some vehicles will have a driver door compartment to store a reflective vest
» page 100.

Warning triangle

With the rear lid open, rotate the lock 90°
» **Fig. 97**. Lower the bracket and remove the warning triangle.

First-aid kit

There is a **first aid kit** » page 166 in the rear left-hand side storage compartment of the luggage compartment.

The first aid kit must comply with legal requirements. Check the expiry date of the contents of the first aid kit.

Fire extinguisher

There is a **Fire extinguisher** underneath the front passenger seat.

The fire extinguisher must conform to legal requirements, be ready for use and be checked regularly. Check the certification seal on the extinguisher.

⚠ WARNING

Loose objects in the vehicle interior can be violently thrown in case of a sudden manoeuvre or braking and especially in accidents causing serious injury.

- **Secure fire extinguishers, first aid kit, reflective vests and warning triangle securely to their respective supports.**

Vehicle tool kit*

Location

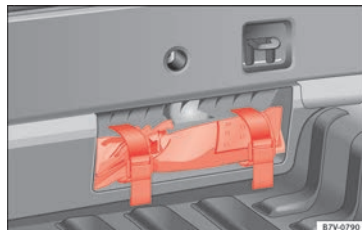


Fig. 98 In the luggage compartment, viewed from inside the vehicle: the vehicle tool kit located in a cavity close to the lock carrier.

When securing the vehicle in case of a breakdown, please note the legal requirements for each country.

Depending on the model, the vehicle tools may be kept in the luggage compartment, in a cavity close to the lock carrier » **Fig. 98**. Loosen the safety straps and remove the vehicle tool kit. For vehicles factory-fitted with winter tyres, you will find additional tools in a toolbox located in the luggage compartment.

⚠ WARNING

Loose objects in the vehicle interior can be violently fired through the compartment in case of a sudden manoeuvre or braking and »

especially in accidents causing serious injury.

- Make sure that the vehicle tools are stored safely in the luggage compartment.

⚠ WARNING

Unsuitable or damaged vehicle tools can cause injury or accidents.

- Never work with inappropriate or damaged tools.

i Note

After use, return the jack to its initial position using the handle in order to securely store it in the vehicle.

Components

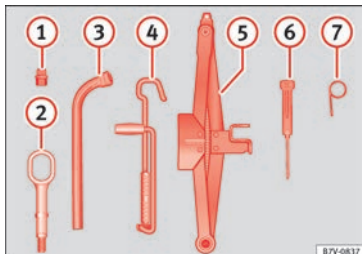


Fig. 99 Components of the vehicle tool kit

The vehicle tool kit depends on the vehicle equipment. The following is a description for a vehicle with all options.

The individual elements of the vehicle tool kit » Fig. 99

- 1 Adapter for anti-theft bolt. SEAT recommend you carry the wheel bolt adapter in the vehicle tool kit at all times. The **code number** of the anti-theft wheel bolt is stamped on the front of the adapter. In case it is lost, another adapter can be ordered using this number. Note the anti-theft bolt code for the wheels and keep it in a place other than the vehicle.
- 2 Towline anchorage, removable.
- 3 Wheel spanner.
- 4 Jack crank handle. The crank handle needs to be folded away before returning it to the tool kit.
- 5 Jack. Before storing the jack in the tool kit, fold its hook.
- 6 Screwdriver with hexagon socket in the handle for screwing and unscrewing the wheel bolts. The screwdriver bit is interchangeable. The screwdriver may be found underneath the wheel spanner.
- 7 Wire hook for pulling off the wheel cover, integral hubcaps and the wheel bolt caps.

i Note

The jack does not generally require any maintenance. If required, it should be greased using universal type grease.

Folding wheel chocks*

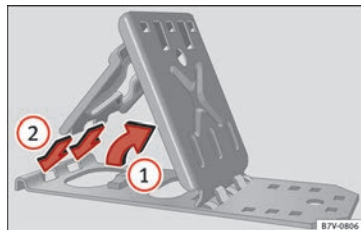


Fig. 100 To unfold the foldable wedges.

The folding chocks are in the tool kit » **Fig. 99**.

Assemble the folding chocks

- Lift the base plate » **Fig. 100** ①.
- Insert the two "tabs" of the mounting plate into the long openings on the base plate ②.

Correct use

The folding chocks may be used to block the wheel diagonally opposite to the wheel being changed.

The chocks should be placed directly in front and behind the wheel and only be used on firm ground.

WARNING

If the folding chocks are assembled or used incorrectly, an accident may occur and serious injury caused.

- Never use damaged chocks.
- Never use chocks to immobilize the vehicle on a slope.

Changing a wheel*

Introduction

Read the additional information carefully

»  page 46

Not all Alhambra models have the TMS (Tyre Mobility System).

If a tyre needs to be changed the tools necessary are available at spare parts dealers:

- Jack,
- box spanner for wheel bolts,
- tool to remove wheel bolt caps

The tyres mounted on the vehicle are anti-puncture. The wheels should only be changed when switching from summer to winter tyres or vice-versa. See » page 293

The vehicle only comes with the necessary tools for changing wheels if factory supplied with winter tyres. If this is not the case, you need to go to a specialised workshop to get the wheels changed.

You should only change the wheels yourself if the vehicle is parked in a safe place, you are familiar with the procedure and safety standards and you have all the necessary tools! Otherwise, you should seek professional assistance.

WARNING

Changing a wheel can be dangerous, especially on the hard shoulder. Please observe the following rules to minimise the risk of injury:

- Stop the vehicle safely as soon as possible. Park at a safe distance from surrounding traffic to change a wheel.
- When changing a wheel, keep all passengers, and particularly children, a safe distance away from the work area.
- Turn on the hazard warning lights to warn other road users.
- Ensure the ground on which you park is flat and solid. If necessary, support the jack on a wide solid base.
- If you are changing a wheel yourself, you should be familiar with the required procedure. Otherwise, you should seek professional assistance.

- Only use suitable tools that are not damaged when changing a wheel.
- Always stop the engine, turn on the electronic parking brake and place the gear selector lever in position P, for an automatic gearbox, or engage a gear for a manual gearbox to reduce the risk of the vehicle moving accidentally.
- Have the tightening torque of the wheel bolts checked as soon as possible with a reliable torque wrench.

WARNING

If the wheel trims are not appropriate or not fitted correctly, they could cause major accidents or damage.

- Incorrectly mounted wheel trims may come off while driving and endanger other road users.
- Damaged trims must never be mounted on the wheels.
- Always ensure that the brake ventilation and cooling is not cut off or blocked. This is also valid if hubcaps are fitted later. If there is not enough air, you may require significantly longer braking distances.

CAUTION

Remove and remount wheel trims taking care to avoid damage to the vehicle.

Tyre repair

TMS (Tyre Mobility System)*

Read the additional information carefully

»  page 45

The Anti-puncture kit* (Tyre Mobility System) will reliably seal punctures caused by the penetration of a foreign body of up to about 4 mm in diameter. **Do not remove foreign objects, e.g. screws or nails, from the tyre.**

Once the sealant is in the tyre, make sure to check the pressure after 10 minutes driving.

If the vehicle has more than one damaged tyre, seek professional assistance. The tyre mobility system is designed for filling one tyre.

Only use the tyre mobility system if the vehicle is properly parked, you know how to do it and the necessary safety measures, and if you have the right kit! Otherwise, you should seek professional assistance.

The tyre sealant should not be used in the following cases:

- If the wheel is damaged.
- The outside temperature is lower than -20°C (-4°F).
- If the tear or puncture on the tyre is over 4 mm wide.

- If you have driven with very low pressure or a flat tyre.
- If the expiry date on the bottle of tyre sealant has passed.

WARNING

Using the tyre mobility system can be dangerous, especially when filling the tyre at the roadside. Please observe the following rules to minimise the risk of injury:

- Stop the vehicle safely as soon as possible. Park it at a safe distance from surrounding traffic to fill the tyre.
- Ensure the ground is flat and firm.
- All occupants, and especially children, should always be at a safe distance outside the work area.
- Turn on the hazard warning lights to warn other road users.
- Use the tyre mobility system only if you are familiar with the necessary procedures. Otherwise, you should seek professional assistance.
- Only use the tyre mobility system in the event of an emergency to get to the nearest workshop.
- Replace the repaired tyre with the tyre mobility set as soon as possible.
- The sealant is hazardous for your health and if it touches your skin, it must be immediately washed off.

- Keep children away from the tyre mobility system.

- Never use a jack even if it is approved for the vehicle.

- To reduce the risk of the vehicle possibly moving on its own, always turn off the engine, set the electronic parking brake and put the selector lever in position P or put into gear if the gearbox is a manual.

WARNING

A tyre filled with sealant does not have the same performance properties as a conventional tyre.

- Never drive faster than 80 km/h (50 mph).
- Avoid heavy acceleration, hard braking and fast cornering.
- Drive for only 10 minutes at a maximum speed of 80 km/h (50 mph) and then check the tyre.

For the sake of the environment

Once used or expired, dispose of the sealant according to legal provisions.

Note

- Sealant bottles can be purchased from SEAT dealers.
- Observe the usage instructions provided by the snow chain manufacturer.

Contents of the tyre mobility system*

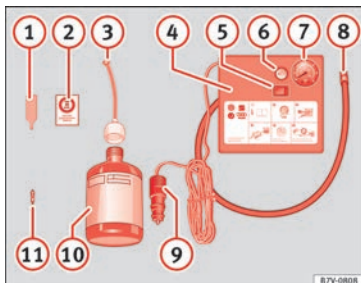


Fig. 101 Standard representation: contents of the anti-puncture kit.

The tyre mobility system is located underneath the floor covering in the boot. It includes the following components » **Fig. 101**:

- ① Tyre valve remover
- ② Sticker indicating maximum speed “max. 80 km/h” or “max. 50 mph”
- ③ Filler tube with cap
- ④ Air compressor
- ⑤ ON/OFF switch
- ⑥ Air bleed screw¹⁾
- ⑦ Tyre pressure monitoring¹⁾

¹⁾ An inflator tube may also be included.

- ⑧ Tube for inflating tyres
- ⑨ 12 volt connector
- ⑩ Bottle of sealant
- ⑪ Spare insert for valve

The **valve insert remover** ① has a gap at the lower end for a valve insert. The valve insert can only be screwed or unscrewed in this way. This also applies to its replacement part ⑪.

⚠ WARNING

When inflating the tyre, the air compressor and the inflator tube may become hot.

- Protect hands and skin from hot parts.
- Do not place the air compressor or inflator tube onto flammable materials while they are hot.
- Before storing the equipment, let it cool.
- If a minimum pressure of 2.0 bar (29 psi / 200 kPa) cannot be reached, the tyre is badly damaged. In this instance, the sealant will not be able to seal the tyre. Do not continue driving. Seek specialist assistance.

ⓘ CAUTION

The air compressor should be turned off after a maximum of 8 minutes since otherwise it will overheat. Before switching it on again, let it cool for a few minutes.

Check after 10 minutes of driving

Screw the inflator tube » **Fig. 101** ⑧ again and check the tyre pressure on the gauge ⑦.

Equal to or below 1.3 bar (19 psi/130 kPa):

- **Stop driving!** The tyre could not be sufficiently sealed with the tyre mobility system.
- You should obtain professional assistance » ⚠.

Equal to or above 1.4 bar (20 psi/140 kPa):

- Correct the tyre pressure until the correct level is reached » page 287.
- Carefully head to the nearest specialised workshop at a maximum speed of 80 km/h (50 mph).
- Ask the workshop to change the damaged tyre.

⚠ WARNING

Driving with a tyre that cannot be sealed is dangerous and may lead to accidents and serious injury.

- Do not continue driving if the tyre pressure is 1.3 bar (19 psi / 130 kPa) or lower.
- Seek specialist assistance.


Changing the windscreen wiper blades

Changing the windscreen and rear window wiper blades

Read the additional information carefully

»  page 55.

The windscreen wiper blades are supplied as standard with a layer of graphite. This layer is responsible for ensuring that the wipe is silent. If the graphite layer is damaged, the noise of the water as it is wiped across the windscreen will be louder.

Check the condition of the wiper blades regularly. **If the wipers scrape across the glass** they should be changed if they are damaged, or cleaned if they are dirty » .


Damaged wiper blades should be replaced immediately. These are available from qualified workshops.

WARNING

Worn or dirty windscreen wiper blades reduce visibility and increase the risk of accident and serious injury.

- Always replace damaged or worn windscreen wiper blades or blades that no longer clean the windscreen properly.

CAUTION

- Damaged or dirty windscreen wipers could scratch the glass.
- If products containing solvents, rough sponges or sharp objects are used to clean the blades, the graphite layer will be damaged.
- Never use fuel, nail varnish remover, paint thinner or similar products to clean the windows.
- In icy conditions, always check that the wiper blades are not frozen to the glass before using the wipers. In cold weather, it may help to leave the vehicle parked with the wipers in service position »  page 55.
- To prevent damage to the bonnet and the wiper arms, only leave them in the service position.
- Before driving, always lower the wiper arms.

Tow-starting and towing

Introduction


Read the additional information carefully

»  page 51

When towing, always respect legal requirements.

For technical reasons, it is not possible to tow a vehicle if the battery is flat.

If the vehicle comes with the Keyless Access system, towing is only allowed with the ignition on!

The vehicle battery drains if the vehicle is towed with the engine switched off and the ignition connected. Depending on the battery charge status, the drop in voltage may be so large, even after just a few minutes, that no electrical device in the vehicle may work e.g. the hazard warning lights. In vehicles with the Keyless Access system, the steering wheel could lock » .

WARNING

A vehicle with a flat battery should never be towed.

- Never remove the key from the ignition lock. Otherwise, the steering wheel lock could suddenly lock. The vehicle would not be controlled and a serious accident could ensue.

WARNING

When towing the vehicle, the handling and braking efficiency change considerably. Please observe the following instructions to minimise the risk of serious accidents and injury:

- As the driver of the vehicle being towed:
 - The brake must be depressed must harder as the brake servo does not operate.

Always remain aware to avoid collision with the towing vehicle.

- More strength is required at the steering wheel as the power steering does not operate when the engine is switched off.
- As the driver of the towing vehicle:
 - Accelerate gently and carefully.
 - Avoid sudden braking and manoeuvres.
 - Brake well in advance than usual and brake gently.

ⓘ CAUTION

- Carefully fit and remove the towline anchorage and its cover to avoid damage to the vehicle (e.g. paintwork).
- When towing, fuel could enter the catalytic converter and cause damage!

📘 Note

- The vehicle can only be towed if the electronic parking brake and steering lock are deactivated. If the vehicle has no power supply or there is an electric system fault, the engine must be started using jump leads to deactivate the electronic parking brake and electronic steering lock.
- Vehicles with the Keyless Access locking and ignition system should only be towed with the ignition connected since, otherwise, the electronic steering lock will not unlock.

Fitting the front towline anchorage



Fig. 102 On the right-hand side of the front bumper: Screw in the towline anchorage.

The location for the removable towline anchorage is on the right-hand side of the front bumper » **Fig. 102**.

The towline anchorage should always be kept in the vehicle.

Note the instructions for towing » page 51.

To fit the towline anchorage

- Take the towline anchorage from the vehicle tool kit » **page 83**.
- Press on the upper cover and carefully remove it forwards. Allow the cover to hang.
- Screw in the towline anchorage into its position **anticlockwise** as far as it will go » **Fig. 102** » ⓘ. Use a suitable tool to firmly tighten the towline anchorage in its location.

- After towing, remove the towline anchorage by turning it **clockwise** and put the cover back in place.

ⓘ CAUTION

The towline anchorage must always be completely and firmly tightened. Otherwise, it could be released while towing and tow-starting.

Fitting the rear towline anchorage

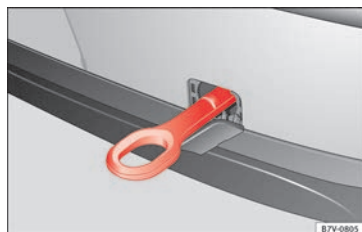




Fig. 103 On the rear bumper, to the right hand side: Towline anchorage in position

The location for the removable towline anchorage is on the right-hand side of the rear bumper » **Fig. 103**. For *vehicles with a factory fitted towing bracket*, there is **no** fitting behind the cover to insert the towline anchorage. For towing, fit and use the tow hitch » **page 237**, » ⓘ.

Note the instructions for towing

»  page 51.

Fitting the towline anchorage to the rear for vehicles without factory fitted tow hitch

- Take the towline anchorage from the vehicle tool kit in the luggage compartment »  page 83.
- Press on the upper cover and carefully remove it back. This may require some strength. Allow the cover to hang.
- Screw in the towline anchorage into its position **anticlockwise** as far as it will go » . Use a suitable tool to firmly tighten the towline anchorage in its location.
- After towing, remove the towline anchorage by turning it **clockwise** and put the cover back in place.

CAUTION

- The towline anchorage must always be completely and firmly tightened. Otherwise, it could be released while towing and tow-starting.
- Vehicles with a factory fitted towing bracket, can only be used for towing with a tow bar, specially designed to fit on a tow hitch ball. Otherwise, the tow hitch ball and the vehicle may be damaged. Otherwise, a tow rope should be used.

Towing advice

Towing requires some expertise and experience, especially when using a tow rope. Both drivers should be familiar with the technique required for towing. For this reason, inexperienced drivers should abstain.

While driving, avoid excessive traction forces and jerking. When towing on an unpaved road, there is always a risk of overloading and damaging the anchorage points.

If the vehicle is towed, with the hazard warning lights on and the ignition switched on, the turn signal may be used to indicate changes of direction. Simply operate the turn signal lever as usual. Meanwhile, the hazard warning lights will go off. When the turn signal lever is returned to the rest position, the hazard warning lights will be turned on automatically.

Notes for the driver of the towed vehicle

- Leave the ignition on to avoid locking the steering wheel, to release the electronic parking brake and to activate the turn signals, the horn as well as the window wipers and window washers.
- As the power assisted steering does not work if the engine is not running, you will need more strength to steer than normally.

- The brake must be depressed must harder as the brake servo does not operate. Avoid hitting the towing vehicle.
- Note the instructions and information contained in the Instruction Manual for the vehicle to be towed.



Notes for the driver of the towing vehicle

- Accelerate gently and carefully. Avoid sudden manoeuvres.
- Brake well in advance than usual and brake gently.
- Note the instructions and information contained in the Instruction Manual for the vehicle to be towed.

Emergency locking and unlocking

Introduction

Read the additional information carefully

»  page 10, »  page 12,

»  page 15

The doors, rear lid and panoramic sliding sunroof can be locked manually and partially opened, for example if the key or the central locking is damaged.

⚠ WARNING

Opening and closing doors carelessly can cause serious injury.

- If the vehicle is locked from outside, the doors and windows cannot be opened from the inside.
- Never leave children or disabled people alone in the car. They could be trapped in the car in an emergency and will not be able to get themselves to safety.
- Depending on the time of the year, temperatures inside a locked and closed vehicle can be extremely high or extremely low resulting in serious injuries and illness or even death, particularly for young children.

⚠ WARNING

Getting in the way of the doors and the panoramic sliding sunroof is dangerous and can lead to serious injury.

- Open and close the doors and the panoramic sliding sunroof only when nobody is in the way.

ⓘ CAUTION

When opening and closing in an emergency, carefully disassemble components and then reassemble them carefully to avoid damage to the vehicle.

Fuses and bulbs

Fuses

Vehicle fuses

Read the additional information carefully

»  page 43

Due to the constant updating of vehicles, fuse assignments based on equipment and the use of the same fuse for various electrical components, it is not possible to provide an up-to-date summary of the fuse positions for the electrical components at the time of printing this manual. For detailed information about the fuse positions, please consult a technical service.

In general, a fuse can be assigned to various electrical components. Likewise, an electrical component can be protected by several fuses.

Only replace fuses when the cause of the problem has been solved. If a newly inserted fuse blows after a short time, you must have the electrical system checked by a specialised workshop as soon as possible.

⚠ WARNING

The high voltages in the electrical system can give serious electrical shocks, causing burns and even death!

- Never touch the electrical wiring of the ignition system.
- Take care not to cause short circuits in the electrical system.

⚠ WARNING

Using unsuitable fuses, repairing fuses or bridging a current circuit without fuses can cause a fire and serious injury.

- Never use a fuse with a higher value. Only replace fuses with a fuse of the same amperage (same colour and markings) and size.
- Never repair a fuse.
- Never replace a fuse by a metal strip, staple or similar.

ⓘ CAUTION

- To prevent damage to the vehicle's electric system, before replacing a fuse always turn off the ignition, the lights and all electrical elements and remove the key from the ignition.
- If you replace a fuse with higher-rating fuse, you could cause damage to another part of the electrical system.
- Protect the fuse boxes when open to prevent the entry of dust or humidity as they can damage the electrical system.
- Always carefully remove the fuse box covers and refit them correctly to avoid problems with your vehicle.

»

- **Protect the fuse boxes when open to avoid the entry of dust or humidity. Dirt and humidity inside fuse boxes can cause damage to the electrical system.**

Note

- **In the vehicle, there are more fuses than those indicated in this chapter. These should only be changed by a specialised workshop.**
- **One component may have more than one fuse.**
- **Several components may run on a single fuse.**

Changing bulbs

Introduction

Changing bulbs requires a certain amount of manual skill. If you are unsure, SEAT recommends that you consult a technical service or request assistance from a specialist. In general, a specialist is required if other vehicle components must be removed or if the discharge bulbs must be replaced.

You should store spare light bulbs in the vehicle for safety-relevant lights. Spare bulbs may be obtained from the technical services. In some countries, it is a legal requirement to carry spare bulbs in the vehicle.

Driving with faults and blown bulbs on the vehicle exterior lighting is against the law.

Additional bulb specifications

The specifications of some headlamp bulbs and bulbs for the rear lamps fitted at the factory may be different to those of conventional bulbs. Bulb information is displayed on the bulb socket or on the bulb itself.

WARNING

If the road is not well-lit and the vehicle is not clearly visible to other drivers, there is a risk of accident.

WARNING

Failure to replace bulbs correctly may cause serious accidents.

- **Before carrying out any work in the engine compartment please read and observe the warnings »» page 271. In any vehicle, the engine compartment is a hazardous area and could cause severe injury.**
- **Discharge lamps work with high-voltage and can cause serious or fatal injury if handled incorrectly.**
- **H7 and discharge bulbs are highly pressurised and could explode when being changed.**
- **Only replace the bulbs concerned when they have cooled.**
- **Never replace bulbs alone if you are not familiar with the operations necessary. If you**


are not sure about procedures then visit a specialised workshop to carry out the necessary work.

- **Never touch the bulb glass directly. Fingerprints will be evaporated by the heat of the operating bulb thus “fogging” up the reflector.**
- **The headlamp frameworks in the engine compartment and the rear lamps contain sharp elements. Always protect your hands when changing bulbs.**

CAUTION

- **After changing a bulb, if the rubber covers are not replaced correctly on the headlamp framework, the electrical installation may be damaged, especially if water is allowed to enter.**
- **Remove the ignition key before working on the electric system. Otherwise, a short circuit could occur.**
- **Switch off the lights and the parking light before changing a bulb.**
- **Take good care to avoid damaging any components.**

Control lamp

	It lights up
A vehicle exterior lighting bulb is not working.	Replace the faulty bulb.

Several warning and control lamps light up for a few seconds when the ignition is switched on, signalling that the function is being verified. They will switch off after a few seconds.

Checking the bulbs of a trailer

For vehicles with the factory fitted towing bracket, certain trailer lights are also controlled if the power socket is correctly connected.

A fault on a trailer turn signal is indicated on the instrument panel by the turn signal blinking twice as fast (↔ or ⇄) » page 130.

- General fault of all turn signals on one side.
- Fault in one rear light (on some models, also the registration light).
- Fault in two brake lights.

⚠ WARNING

Observe the safety warnings » ⚠ in Control and warning lamps on page 107.

i Note

A fault in the LED on the rear lights will not be indicated. However, if the fault affects all the LEDs then this will be indicated by the control lamp 🚗.

To replace halogen headlight bulbs

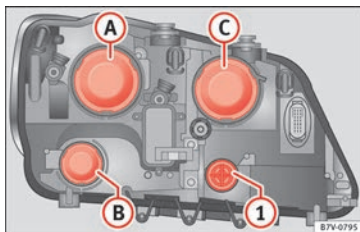


Fig. 104 In the engine compartment: left-hand side headlight lining. **A** dipped beam headlights, **B** daytime driving lights and **C** main beam headlights and side lights

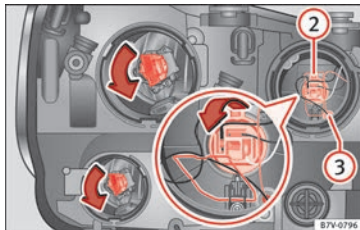


Fig. 105 Left headlight.

There is no need to remove the headlight to replace bulbs.

Complete operations only in the sequence given:

Turn signals (small bulb holder)

1. Open the bonnet ⚠ » page 271.
2. Rotate the bulb holder **1** to the left all the way and pull it out backwards together with the bulb.
3. Depending on the model, the bulb is removed directly from the bulb holder or it may need to be rotated and then removed.
4. Replace the faulty bulb with a new identical bulb.
5. Place the bulb holder in the headlight and rotate to the right all the way.

Dipped beam **A** and daytime lights **B**

1. Open the bonnet ⚠ » page 271.
2. Remove the rubber cover on the rear of the headlight.
3. Rotate the bulb holder to the left all the way and pull it out backwards together with the bulb.
4. Depending on the model, the bulb is removed directly from the bulb holder or it may need to be rotated and then removed.
5. Replace the faulty bulb with a new identical bulb.
6. Place the bulb holder in the headlight and rotate to the right all the way.
7. Insert the rubber cover. »

	Main beam head-lights C	Side lights C
1.	Open the bonnet A » page 271.	
2.	Remove the rubber cover on the rear of the headlight.	
3.	Press the wire clip downwards and pull the bulb holder 2 out together with the bulb.	Pull the bulb holder 3 out backwards together with the bulb.
4.	Depending on the model, the bulb is removed directly from the bulb holder or it may need to be rotated and then removed.	
5.	Replace the faulty bulb with a new identical bulb.	
6.	Place the bulb holder in the headlight and pull the wire clip upwards until it clicks into place.	Place the bulb holder in the headlight and insert completely.
7.	Insert the rubber cover.	

i Note

The images show the left hand headlight from behind. The structure of the right hand side headlight is symmetric.

To replace the xenon headlight bulb

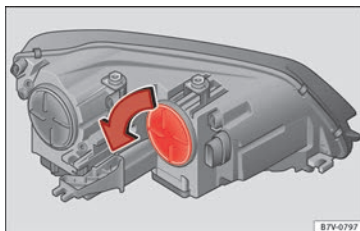


Fig. 106 In the engine compartment: turn signal indicator cover.

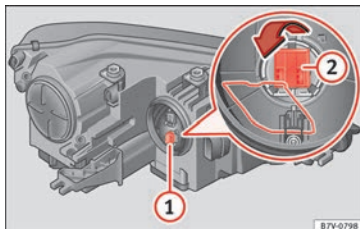


Fig. 107 Turn signal bulb holder **1** and turning light **2**.

There is no need to remove the headlight to replace bulbs.

Complete operations only in the sequence given:

	Turn signals 1	Turning lights 2
1.	Open the bonnet A » page 271.	
2.	Rotate the cover » Fig. 106 in the direction of the arrow and remove it.	
3.	Rotate the bulb holder 1 » Fig. 107 to the left all the way and pull it out backwards together with the bulb.	Press the wire clip downwards and pull the bulb holder 2 » Fig. 107 out together with the bulb.
4.	Depending on the model, the bulb is removed directly from the bulb holder or it may need to be rotated and then removed.	
5.	Replace the faulty bulb with a new identical bulb.	
6.	Place the bulb holder in the headlight and rotate to the right all the way.	Place the bulb holder in the headlight and pull the wire clip upwards until it clicks into place.
7.	Rotate the cover » Fig. 106 in the opposite direction to the arrow as far as it will go.	

Always seek the help of a specialist when changing the Xenon dipped beam and main beam headlamps » **A** in Introduction on page 92.

i Note

The illustrations show the left hand headlight. The structure of the right hand side headlight is symmetric.

Replacing the front bumper bulbs



Fig. 108 On the right-hand side of the front bumper: removing the headlights.

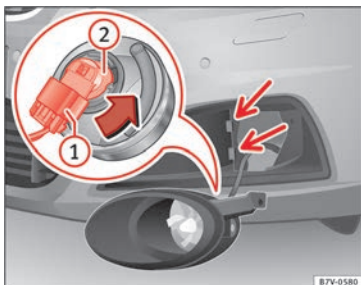


Fig. 109 Changing the bulbs in the headlights

Complete operations only in the sequence given:

1. Pull the cover forwards, in the direction of the arrow » **Fig. 108**.
2. Unscrew the attachment screw » **Fig. 108 1** using the screwdriver from the vehicle tool kit » page 83.
3. Tilt the headlight slightly forward and extract it from its lateral attachments » **Fig. 109** (small arrows).
4. Release the connector » **Fig. 109 1** and remove it.
5. Rotate the bulb holder » **Fig. 109 2** to the left all the way, in the direction of the arrow, and pull it out backwards together with the bulb.
6. Replace the faulty bulb with a new identical bulb.
7. Place the bulb holder in the headlight and rotate to the right all the way.
8. Insert the connector » **Fig. 109 1** on the bulb holder **2**. The connector must audibly click into place.
9. Place the headlight into its position » **Fig. 109** (small arrows) and tilt it backwards.
10. Tighten the attachment screw » **Fig. 108 1** using the screwdriver.
11. Replace the cover on the bumper » **Fig. 108**.

Replacing the rear lid bulbs

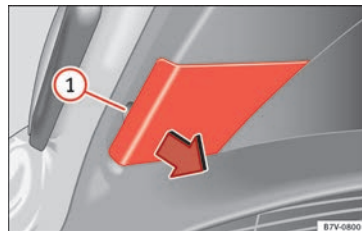


Fig. 110 On the rear lid: Remove the cover.

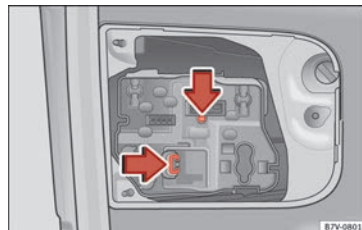


Fig. 111 On the rear lid: remove the bulb-holder.

Complete operations only in the sequence given:

1. Open the rear lid » page 124. »

2. Extract the cover carefully using the flat part of the screwdriver from the vehicle tool kit as a lever (» Fig. 99) on the indent » Fig. 110 ①.
3. Release the bulb holder connector by pulling on the red connector block.
4. Press on the attachment tabs in the direction of the arrow » Fig. 111 and pull out the bulb holder.
5. Replace the faulty bulb with a new identical bulb.
6. Install the bulb holder. The attachment tabs should audibly click into place.
7. Insert the cover. The cover should lock into place.

Replacing the rear bulbs in the body

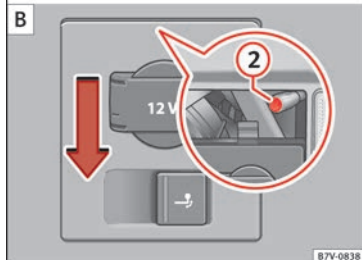
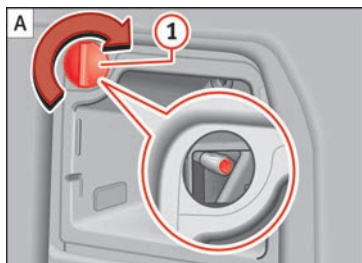


Fig. 112 On the side of the luggage compartment: removing the left and right hand side rear lights. ① remove the cap; ② attachment screw

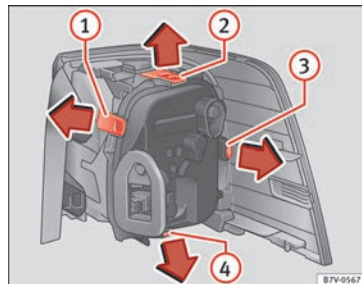


Fig. 113 Rear lights in the body: Remove the bulb holder. ① to ④: Attachment tab

Complete operations only in the sequence given.

Removing the rear light units

Complete operations only in the sequence given:

	Rear light, left	Rear light, right
1.	Open the rear lid » page 124.	
2.	Open the storage compartments on the left-hand side of the luggage compartment » page 166.	Move the 12 V power socket support by pressing gently downwards » Fig. 112 ② (arrow).
3.	Rotate the cap ① 90° in the direction of the arrow and remove it.	

	Rear light, left	Rear light, right
4.	Unscrew the attachment screw » Fig. 112 ② using the screwdriver from the vehicle tool kit » page 83. The bolt is secured in its position.	
5.	Extract the rear light from the bodywork by carefully pulling backwards.	
6.	Pull the red strip on the connector and extract the connector.	
7.	Disassemble the tail light unit and place it on a flat, clean surface.	

To change the bulb

8.	To release the bulb holder, press on the attachment tabs » Fig. 113 ① to ④ in the direction of the arrow.
9.	Remove the bulb holder from the rear light unit.
10.	Replace the faulty bulb with a new identical bulb.
11.	Place the bulb holder in the tail light unit. The attachment tabs should audibly click into place.
12.	Insert the connector and press the red attachment strip in so that the connector is locked into place.

Assembling the rear light units

Complete operations only in the sequence given:

	Rear light, left	Rear light, right
13.	Carefully insert the tail light unit into the opening in the bodywork. To do this, insert the upper rear light unit guide into the attachment ring.	
14.	Tighten the white attachment screw using the screwdriver from the vehicle tool kit.	
15.	Ensure that the tail light unit has been correctly fitted and is firmly secured.	
16.	Replace the cap » Fig. 112 ① and rotate it 90° in the opposite direction of the arrow.	Move the 12 V power socket support upwards gently until it is correctly closed.
17.	Close the storage compartment.	
18.	Close the rear lid » page 124.	

Changing the number plate light



Fig. 114 On the rear bumper: number plate lights

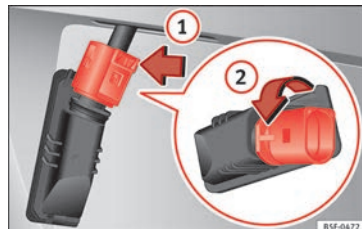


Fig. 115 Number plate light: Remove the bulb holder.

Complete operations only in the sequence given: »

Emergencies

	Fixed number plate light	Bolted number plate light
1.	Press the flat part of the screwdriver included in the vehicle on-board tools (» Fig. 99) in the direction of the arrow, in the groove of the number plate light » Fig. 114.	Unscrew the number plate light screws using the screwdriver from the vehicle tool kit (» Fig. 99).
2.	Detach the number plate light.	
3.	Turn the connector lock » Fig. 115 in the direction of arrow ① and pull on the connector.	Separate the attachment tabs from the rear panel of the number plate light by pressing.
4.	Rotate the bulb holder in the direction of the arrow » Fig. 115 ② and extract it together with the bulb.	Take the bulb holder out of the number plate light.
5.	Replace the faulty bulb with a new identical bulb.	
6.	Insert the bulb holder into the number plate light and rotate all the way in the opposite direction to the arrow » Fig. 115 ②.	Insert the bulb holder into the number plate light.
7.	Plug the connector into the bulb holder.	Press on the attachment tabs. The bulb holder must be firmly attached to the number plate light.

	Fixed number plate light	Bolted number plate light
8.	Insert the number plate light carefully into the opening on the bumper. Ensure that the number plate light is in the correct position.	
9.	Insert the number plate light into the bumper until it audibly clicks into place.	Tighten the attachment screws for the number plate light using the screwdriver.

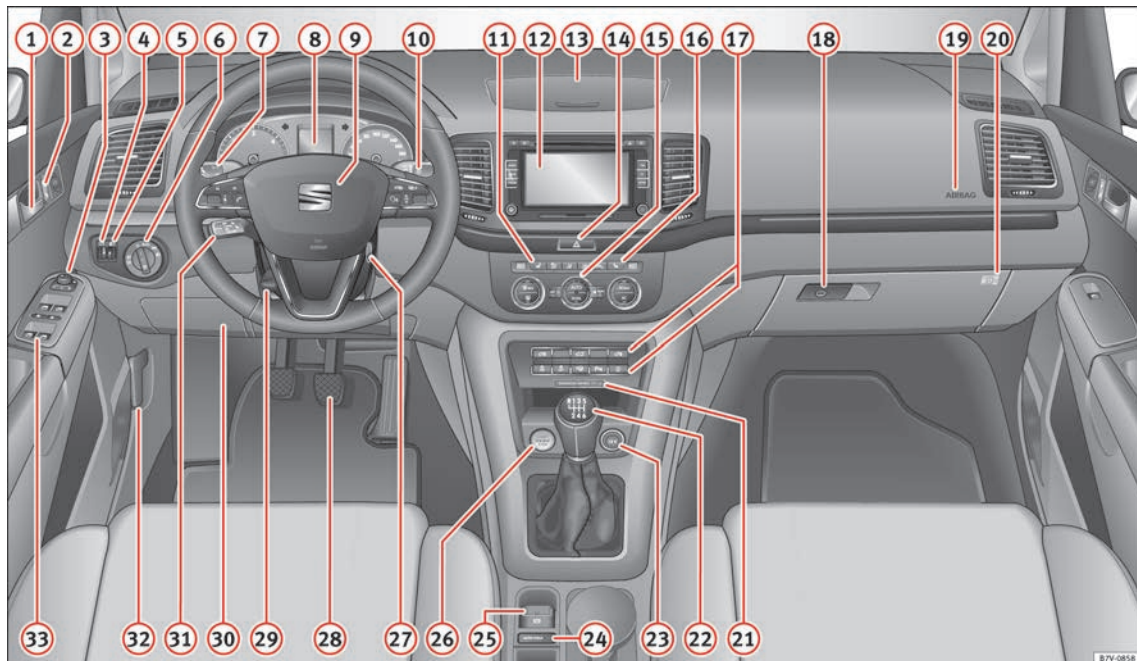


Fig. 116 Dash panel.

B7V-0858

Operation

General instrument panel

Instrument panel

① Door release lever	121		
② Central lock button / 	114		
③ Switch for adjusting the exterior mirrors	140		
– Exterior mirror adjustment L – R – 0			
– Exterior mirror heating			
– Folding exterior mirrors			
④ Brightness regulation for instrument panel and controls 	130		
⑤ Headlamp range adjustment 	130		
⑥ Light switch 	130		
– Light off 0			
– Automatic dipped beam headlight control AUTO			
– Side/dipped lights /			
– Fog lights			
⑦ Lever for	130		
– Main beam headlights			
– Headlight flasher			
– Turn signals			
– Parking lights			
⑧ Instrument panel:			
– Instruments	102	⑬ Storage compartment	166
– Digital display	102	⑭ Hazard warning lights switch ..	134
– Warning and indication lamps ...	107	⑮ Switches for:	
⑨ Steering wheel with horn and		– Electronic manual air conditioning	176
– Driver airbag	19	– Climatronic	176
– On-board computer controls ...	27	⑯ Right seat heating controls 	147
– Controls for radio, telephone, navigation and speech dialogue system »» Booklet Radio		⑰ Button for:	
– Paddle levers for tiptronic gearshift (automatic gearbox)	196	– Anti-slip regulation (ASR) 	188
⑩ Windscreen wiper/ windscreen wash lever	137	– Start-Stop operation 	208
– Windscreen wipers HIGH – LOW		– Parking distance warning system (ParkPilot) 	211
– Intermittent wipe		– Park Assist system 	214
– “Touch wipe”		– Tyre pressure monitor SET ...	234
– Windscreen wipers		– Dynamic chassis control (DCC) C S	
– Automatic windscreen wash/wipe		– Opening the rear lid 	124
– Rear window wiper system		– Opening and closing of electric sliding doors 	122
– Automatic rear window wash/wipe		⑱ Locking handle to open glove compartment	166
– Lever with buttons for controlling the SEAT information system TRIP – OK/RESET	27	⑲ Position of passenger front airbag on the dash panel	19
⑪ Left seat heating controls 	147	⑳ Key-operated switch in glove compartment for deactivating front passenger front airbag	20
⑫ Radio or navigation system (fitted at factory) »» Booklet Radio or »» Booklet Navigation system		㉑ Passenger front airbag off warning lamp	73 »»

22	Lever for:			
	– Manual gearbox	193		
	– Automatic gearbox	193		
23	12 volt power socket	173		
24	Auto Hold switch AUTO HOLD	208		
25	Electronic parking brake switch (P)	188		
26	Start-up push button (Keyless Access closing and start-up system)			
27	Ignition lock	183		
28	Pedals	193		– Childproof locks ④ 121
29	Steering column adjustment lever	58		
30	Fuse box cover	91		
31	Lever for:			
	– Cruise Control System (CCS) OFF – CANCEL – ON – RESUME – SPEED – SET	221		
32	Open bonnet lever	271		
33	Controls for:			
	– Electric windows	127		

Note

- Some of the items of equipment listed here are fitted only on certain model versions or are optional extras.
- In versions with the steering wheel on the right, the layout of the control elements is somewhat different. But the symbols assigned to the controls correspond to the symbols used in the versions with the steering wheel on the left

Instruments

View of instrument panel

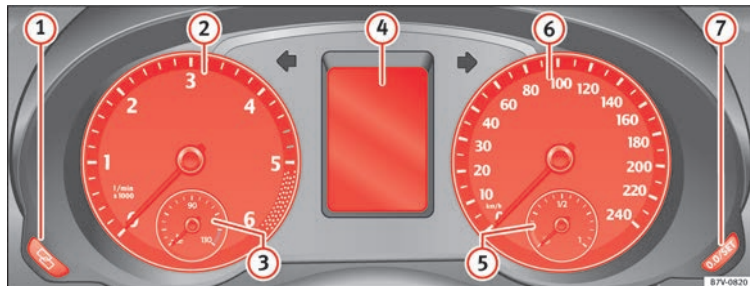



Fig. 117 Instrument panel, on dash panel.

Details of the instruments » **Fig. 117:**

① **Clock set button**¹⁾.

– Press the  button to select the hour or minute display.

– To continue setting, press **0.0 / SET**
 » **Fig. 117 7**. Hold button down to scroll through the numbers quickly.

– Press the **☐** button again to end the clock setting.

- 2 Rev counter** (with the engine running, in thousands of revolutions per minute).

Together with the gear-change indicator, the rev counter offers you the possibility of using the engine of your vehicle at a suitable speed. The start of the red area » **Fig. 117** indicates the maximum engine speed working at operating temperature. However, it is advisable to change up a gear or move the selector lever to **D** (or lift your foot off the accelerator) before the needle reaches the red zone » **1**. We recommend that you avoid high revs and that you follow the recommendations on the gear-change indicator. Consult the additional information in » **page 197**.

- 3 Engine coolant temperature display** **⚡**
 » **page 277**.
- 4 Displays on the screen** » **page 103**.
- 5 Fuel reserve display** » **page 264**.
- 6 Speedometer**.
- 7 Reset knob** for trip recorder (**trip**).

– Press button **0.0 / SET** to reset to zero.

⚠ WARNING

Any distraction may lead to an accident, with the risk of injury.

- Do not operate the instrument panel controls when driving.

ⓘ CAUTION

To prevent damage to the engine, the rev counter needle should only remain in the red zone for a short period of time.

♻ For the sake of the environment

Changing up a gear in time reduces fuel consumption and noise.

Indications on the display

A variety of information can be viewed on the instrument panel display » **Fig. 117 4**, depending on the vehicle equipment:

- Warning and information text.
- Mileage.
- Time.

- Outside temperature.
- Compass.
- Selector lever positions » **page 193**.
- Recommended gear (manual gearbox) » **page 193**.
- Multifunction display (MFD) and menus for different setting options » **page 27**.
- Service interval display » **page 105**.
- Second speed display (menu **Configuration**) » **page 27**.
- Start-Stop operation indicator » **page 104**.



Warning and information texts

The system runs a check on certain components and functions when the ignition is switched on and while the vehicle is moving. Faults in the operation are displayed on the screen using red and yellow symbols and messages on the instrument panel display (» **page 107**) and, in some cases, with audible warnings. The display may vary according to the type of instrument panel fitted. »

¹⁾ Depending on the vehicle equipment, it is also possible to set the time using the **settings** menu on the instrument panel display » **page 31**.

Priority 1 warning (red symbols)


Symbol flashing or lit; partly combined with audible warnings.

 **Stop the vehicle!** It is dangerous  in Control and warning lamps on page 107 !

Check the function that is faulty and repair it. If necessary, request assistance from specialised personnel.

Priority 2 warning (yellow symbols)

Symbol flashing or lit; partly combined with audible warnings.

A function fault, or fluids which are below the correct levels may cause damage to the vehicle  in Control and warning lamps on page 107 !

Check the faulty operation as soon as possible. If necessary, request assistance from specialised personnel.

Informative text

Information relating to different vehicle processes.


Mileage


The *odometer* registers the total distance travelled by the car.

The *odometer (trip)* shows the distance travelled since the last odometer reset. The last digit of the trip recorder indicates distances of 100 metres or one tenths of a mile.

Outside temperature display


When the outside temperature is below +4°C (+39°F), the “ice crystal” symbol (warning of risk of freezing) is also displayed next to the

temperature. At first this symbol flashes and then it remains lit until the outside temperature rises above +6°C (+43°F) .

When the vehicle is at a standstill, with the auxiliary heating on ( page 180), or when travelling at very low speeds, the temperature displayed may be higher than the true outside temperature, as a result of the heat produced by the engine.

The temperatures measured range from -40°C to +50°C (-40°F to +122°F).


Compass

With the ignition on and the navigation system on, the cardinal point corresponding to the vehicle's direction of travel is displayed on the instrument panel  page 105.



Selector lever positions

The range of engaged gears of the selector lever is shown on the side of the lever, and on the instrument panel display. In positions **D** and **S**, and with the Tiptronic, the corresponding gear is also displayed.



Recommended gear (manual gearbox)

The recommended gear in order to save fuel is displayed on the instrument panel while you are driving  page 193.

Second speed display (mph or km/h)


In addition to the speedometer, the speed can also be displayed in a different unit of measurement (in miles or in km per hour). To change the units, in the **Settings** menu, select the option **Second speed**   page 27.

Vehicles without menu display on the instrument panel


- Switch on the engine.
- Press the  button three times. The odometer display flashes on the instrument panel display.
- Press button  once. “mph” or “km/h” is displayed briefly instead of the odometer.
- This activates the second speed display. To switch it off, repeat the procedure.

This option cannot be deactivated in models destined for countries in which the second speed must always be visible.

Start-Stop operating display.

Updated information relating to the status is displayed on the instrument panel  page 208.

WARNING

Observe the safety warnings  in Control and warning lamps on page 107.

WARNING

Even though outside temperatures are above freezing, some roads and bridges may be icy.

- At outside temperatures above +4°C (+39°F), even when the “ice crystal” symbol is not visible, there may still be patches of ice on the road.
- Do not rely on the outside temperature indicator!

Note

- Different versions of the instrument panel are available and therefore the versions and instructions on the display may vary. In the case of displays without warning or information texts, faults are indicated exclusively by the warning lamps.
- When several warnings are active at the same time, the symbols are shown successively for a few seconds and will stay on until the fault is rectified.

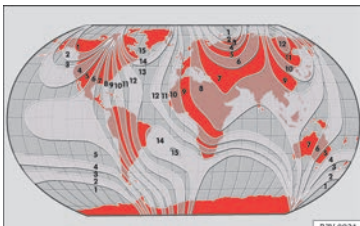
Compass*

Fig. 118 Magnetic zones

The compass does not require calibration in vehicles for which the navigation system was mounted at the factory. The option **compass** disappears.

The compass in vehicles in which the navigation system was not mounted at the factory, is permanently and automatically calibrated. If electronic or metal accessories (mobile phone, television) are subsequently mounted in the vehicle, the compass should be recalibrated manually.

Adjusting the magnetic zone

- Switch the ignition on.
- Select the **Settings** menu followed by the option **Compass** and **Zone**.
- Select the magnetic zone corresponding to the position of the vehicle » Fig. 118.

- Adjust and confirm the magnetic zone (1–15).

Calibrating compass

To calibrate the compass you must be in one of the valid magnetic zones with sufficient space to be able to trace a circumference with the vehicle.

- Switch the ignition on.
- Select the **Settings** menu followed by the option **Compass** and **Calibrate**.
- Confirm the message **Describe a complete circumference to calibrate the compass** with **OK** and then trace a complete circumference driving at approximately 10 km/h (6 mph).

When the corresponding cardinal point is displayed, the calibration is complete.

Service interval display

The service indication is shown on the dash panel display » Fig. 117 ④.

SEAT distinguishes between services *with* engine oil change (Interval Service) and services *without* engine oil change (Inspection Service). The service interval display only gives information for service dates which involve an engine oil change. The dates for the »


other services (e.g. the next Inspection Service or change of brake fluid) are listed on the label attached to the door strut, or in the Maintenance Programme.

In vehicles with **Services established by time or mileage**, the service intervals are already pre-defined.

In vehicles with **LongLife Service**, the intervals are determined individually. Technical progress has made it possible to considerably reduce servicing requirements. The technology used by SEAT ensures that your vehicle only has an Interval Service when it is necessary. To establish when the Interval Service is due (max. 2 years), the vehicle's conditions of use and individual driving styles are considered. The service pre-warning first appears 20 days before the date established for the corresponding service. The kilometres (miles) remaining until the next service are always rounded up to the nearest 100 km (miles) and the time is given in complete days. The current service message cannot be viewed until 500 km after the last service. Prior to this only lines are visible on the display.


Inspection reminder

When the Service date is approaching, when the ignition is switched on a **Service reminder** is displayed.

In *vehicles without text messages*, a spanner symbol  is displayed on the instrument panel and a figure given in **km**. The number of kilometres shown is the maximum number that may be driven until the next service. After a few seconds, the display mode changes. A clock symbol appears and the number of days until the next service appointment is due.



In *vehicles with text messages*, **Service in --- km (miles) or --- days** is displayed on the instrument panel.

Service due

After **the service date**, an audible warning is given when the ignition is switched on and the spanner displayed on the screen  flashes for a few seconds. In *vehicles with text messages*, **Service in --- km or --- days** is displayed on the instrument panel.

Reading a service notification

With the ignition switched on, the engine off and the vehicle at a standstill, the current **service notification** can be read:

- Press the  button on the instrument panel several times until the spanner symbol  is displayed.
- **OR:** select the **Settings** menu.
- From the **Service** submenu, select the option **Info**.

When the **service date has past**, a minus sign is displayed in front of the number of kilometres or days. In *vehicles with text messages* the following is displayed: **Service --- km (miles) or --- days ago**.

Resetting service interval display

If the service was not carried out by a technical service centre, the display can be reset as follows:

In vehicles with text messages:

Select the **Settings** menu.

In the submenu **Service**, select the option **Reset**.


Confirm with **OK** when requested to do so by the system.

In vehicles without text messages:

Switch the ignition off.

Press and hold the **(0.0 / SET)** button.

Switch the ignition back on.

Release the **(0.0 / SET)** button and press  for the next 20 seconds.

Do not reset the indicator to zero between two intervals, otherwise the display will be incorrect.

If you reset the display manually, the next service interval will be indicated as in vehicles with fixed service intervals. For this


reason we recommend that the service interval display be reset by a SEAT authorised service »» Booklet Maintenance schedule.



Note

- The service message disappears after a few seconds, when the engine is started or when **OK** is pressed.
- In vehicles with the LongLife system in which the battery has been disconnected for a long period of time, it is not possible to calculate the date of the next service. Therefore the service interval display may not be correct. In this case, bear in mind the maximum service intervals permitted in the »» Booklet Maintenance Programme.

Control lamps

Control and warning lamps

Read the additional information carefully »»  page 34

The control and warning lamps are indicators of warnings, »» , faults »»  or certain functions. Some control and warning lamps come on when the ignition is switched on, and switch off when the engine starts running, or while driving.

Depending on the model, additional text messages may be viewed on the instrument

panel display. These may be purely informative or they may be advising of the need for action »» page 102, Instruments.

Depending upon the equipment fitted in the vehicle, instead of a warning lamp, sometimes a symbol may be displayed on the instrument panel.

When certain control and warning lamps are lit, an audible warning is also heard.

WARNING

If the warning lamps and messages are ignored, the vehicle may stall in traffic, or may cause accidents and severe injuries.

- Never ignore the warning lamps or text messages.
- Stop the vehicle safely as soon as possible.
- Park the vehicle away from traffic and ensure that there are no highly flammable materials under the vehicle that could come into contact with the exhaust system (e.g. dry grass, fuel).
- A faulty vehicle represents a risk of accident for the driver and for other road users. If necessary, switch on the hazard warning lamps and put out the warning triangle to advise other drivers.
- Before opening the bonnet, switch off the engine and allow it to cool.
- In any vehicle, the engine compartment is a hazardous area and could cause severe injuries »» page 271.

CAUTION

Failure to heed the control lamps and text messages when they appear may result in faults in the vehicle.

Communications and multimedia

Steering wheel controls*

Operating the audio system + telephone

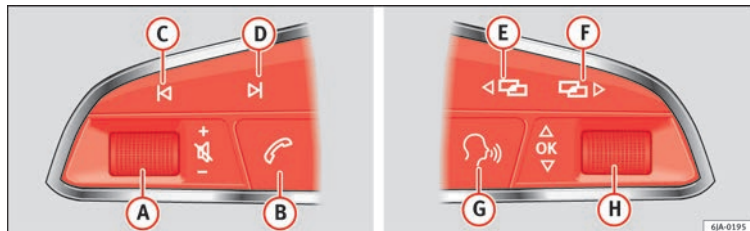


Fig. 119 Controls on the steering wheel.

The steering wheel includes a multifunction module from where it is possible to control the audio, telephone and radio/navigation

functions without needing to distract the driver.

- control of the available audio functions (radio, audio CD, MP3, iPod^{®1)}, USB¹⁾, SD¹⁾) and the Bluetooth system from the steering wheel.

Button	Radio	Media (except AUX)	AUX	Telephone ^{a)}	Navigation ^{a)}
A	Turn: Turn volume up/down Press: Mute	Turn: Turn volume up/down Press: Pause	Turn: Turn volume up/down Press: Mute	Turn: Turn volume up/down Press: Mute	Turn: Turn volume up/down Press: Mute

¹⁾ Depending on the vehicle equipment.

Communications and multimedia

Button	Radio	Media (except AUX)	AUX	Telephone ^{a)}	Navigation ^{a)}
B	<p><i>Short press:</i> access to the telephone menu on the dash panel^{a)}.</p> <p><i>Hold down:</i> redial^{a)}</p>	<p><i>Short press:</i> access to the telephone menu on the dash panel^{a)}.</p> <p><i>Hold down:</i> redial^{a)}</p>	<p><i>Short press:</i> access to the telephone menu on the dash panel^{a)}.</p> <p><i>Hold down:</i> redial^{a)}</p>	<p><i>Short press:</i> answer/hang up calls, enable/open the telephone menu.</p> <p><i>Hold down:</i> reject incoming call/switch to private mode or return to hands-free mode/redial</p>	<p><i>Short press:</i> access to the telephone menu on the dash panel^{a)}.</p> <p><i>Hold down:</i> redial^{a)}</p>
C, D	Search for the previous/next station	<p><i>Short press:</i> switch to the previous/next song</p> <p><i>Hold down:</i> Fast rewind/forward</p>	No function	No function ^{b)}	Radio/media functionality (except AUX)
E, F	Change menu on instrument panel	Change menu on instrument panel	Change menu on instrument panel	Change menu on instrument panel	Change menu on instrument panel
G	Enable/disable voice control ^{a)}	Enable/disable voice control ^{a)}	Enable/disable voice control ^{a)}	No function ^{b)}	Enable/disable voice control
H	<p><i>Turn:</i> Next/previous preset^{c)}</p> <p><i>Press:</i> Acts on the MFD or confirms the menu option of the dash panel depending on the menu option</p>	<p><i>Turn:</i> Next/previous song^{c)}</p> <p><i>Press:</i> Acts on the MFD or confirms the menu option of the dash panel depending on the menu option</p>	<p><i>Turn:</i> Acts upon the instrument panel menu depending on position</p> <p><i>Press:</i> Acts on the MFD or confirms the menu option of the dash panel depending on the menu option</p>	<p><i>Turn:</i> Acts upon the instrument panel menu depending on position</p> <p><i>Press:</i> Acts on the MFD or confirms the menu option of the dash panel depending on the menu option</p>	<p><i>Turn:</i> Acts upon the instrument panel menu depending on position</p> <p><i>Press:</i> Acts on the MFD or confirms the menu option of the dash panel depending on the menu option</p>

^{a)} According to the vehicle's equipment package.

^{b)} When a call is being made, radio/media functionality (except AUX).

^{c)} Only if the dash panel is in audio menu.

Multimedia

USB/AUX-IN input



Fig. 120 Front centre armrest: USB/AUX-IN input.

Depending on the features and the country, the vehicle may have a USB/AUX-IN connection.

The USB/AUX-IN input is in the front centre armrest » **Fig. 120**.

The operating description is located in the respective Instruction Manuals of the audio system or the navigation system.

Convenience phone system

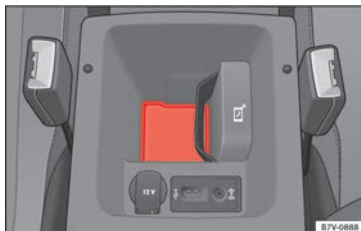


Fig. 121 Front centre armrest: phone holder for connecting the mobile phone to the car's external aerial.

Depending on the equipment and country, the vehicle may have the **Convenience phone system** connected to the vehicle's exterior aerial » **Booklet Media System Plus**.

This system is located in the front centre armrest compartment.

Three button unit in headliner

Three button unit*



Fig. 122 Three button unit in headliner: controls for the telephone management system.

☆	<p><i>Press it briefly:</i> to accept or end a call. <i>Press the button:</i> to reject a call.</p>
i	<p><i>Press it briefly:</i> to start or stop the voice control function, for example, to make a call.^{a)}</p>
🔧	<p><i>Press the button for more than 2 seconds:</i> to obtain information about the SEAT brand and selected additional services related to traffic and travel.</p>
	<p><i>Press the button for more than 2 seconds:</i> to obtain help from the network of SEAT dealers in the event of a breakdown.</p>

^{a)} Not operational if a navigation system with voice control is fitted.

Information and assistance calls

Communication with the SEAT Customer Care Service is established using the **i** and **📞** buttons of the three-button unit¹⁾. The system will automatically connect you with the Assistance Centre of the relevant country. You will only be able to make calls if your mobile is turned on and connected to the pre-installed Bluetooth.

Information call

The **Information call i** button offers information on the SEAT brand and selected additional services related to traffic and your travel.

To establish communication, press the **i** button for more than 2 seconds.

In countries where there is no information telephone number, an information call is made by pressing the **i** button.

Assistance call

The **assistance call 📞** button gives immediate help in case of a breakdown. To this end, the SEAT dealer network, with its mobile assistance vehicles, is at your disposal.

To establish communication, press the **📞** button for more than 2 seconds.

i Note

- **Calls made with the **i** and **📞** buttons take priority over normal calls. If the **i** or **📞** button is pressed during a normal telephone call, this call will be cut off and an information call or assistance call will be made.**
- **If the assistance call button **📞** is pressed during an information call, the information call will be interrupted to make the assistance call (and vice versa).**
- **Mobile phone coverage must be available to place a call to the information and assistance services. This service might not be available in some countries.**

Activating and deactivating

Switching on the speech control system

- Press the **🗨️** button on the multi-function steering wheel.
- **OR:** on the three-button unit, press ☆.
- Wait for the acoustic signal.
- Give the command.
- Follow the dialogue instructions (extended dialogue).

Ending voice control

- Press the **🗨️** button on the multi-function steering wheel.
- **OR:** on the three-button unit, press ☆.

Interrupting the instructions

- During the instructions, press the **🗨️** button on the multi-function steering wheel.
- **OR:** on the three-button unit, press ☆.
- You will be able to give a command immediately afterwards.

¹⁾ Depending upon country.

Opening and closing

Vehicle key set

Vehicle key



Fig. 123 Vehicle keys



Fig. 124 Vehicle key for vehicles with electric sliding doors

Vehicle keys

With the vehicle key » Fig. 123 or » Fig. 124 the vehicle may be locked or unlocked remotely.

The vehicle key includes an emitter and batteries. The receiver is in the interior of the vehicle. The range of the vehicle key with remote control and new batteries is several metres around the vehicle.

If it is not possible to open or close the vehicle using the remote control key, this should be re-synchronised » page 114 or the battery changed » page 113.

Different keys belonging to the vehicle may be used.

Folding the key shaft in and out

When the button is pressed (A), the key shaft is released and unfolds.

To *fold it* press button (A) and fold the key shaft in until it locks in place.

Spare key

To obtain a spare key and other vehicle keys, the vehicle chassis number is required.

Each new key must contain a microchip and be coded with the data from the vehicle electronic immobiliser. A vehicle key will not work if it does not contain a microchip or the microchip has not been encoded. This is also true for keys cut for the vehicle.

The vehicle keys or new spare keys can be obtained from a technical service centre, a specialised workshop or approved key service qualified to provide this kind of key.

New keys or spare keys must be synchronised before use » page 114.

⚠ WARNING

Careless or incorrect use of vehicle keys may result in severe injury and accident.

- Always take all the keys with you whenever you leave the vehicle. Children and unauthorised individuals could lock the doors or the boot hatch, start the engine or turn on the ignition, activating electrical systems, the electric windows, for example.
- Never leave children or disabled people alone in the car. They could be trapped in the car in an emergency and will not be able to get themselves to safety. For example, depending on the time of the year, temperatures inside a locked and closed vehicle can be extremely high or extremely low resulting in serious injuries and illness or even death, particularly for young children.
- Never remove the key from the ignition if the vehicle is in motion. The steering may lock and it will not be possible to turn the steering wheel.

ⓘ CAUTION

All of the vehicle keys contain electronic components. Protect them from damage, impacts and humidity.

ⓘ Note

- Only use the key button when you require the corresponding function. Pushing the button unnecessarily could accidentally unlock the vehicle or trigger the alarm. It is also possible even when you are outside the radius of action.
- Key operation can be greatly influenced by overlapping radio signals around the vehicle working in the same range of frequencies (e.g. radio transmitters, mobile telephones).
- Obstacles between the remote control and the vehicle, bad weather conditions and draining batteries can considerably reduce the range of the remote control.

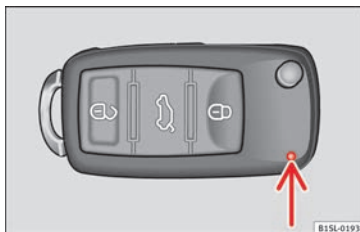
Control lamp on the vehicle key

Fig. 125 Control lamp on the vehicle key

When a button on the vehicle key is pressed, the control lamp flashes »» **Fig. 125** (arrow) once briefly. If the button is pressed and held, the indicator blinks several times (e.g. for the convenience opening function).

When the control lamp does not light upon pushing a button, the batteries of the key must be changed »» **page 113**.

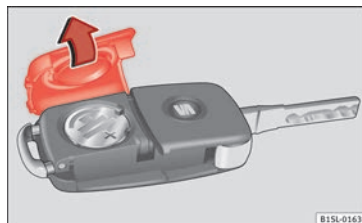
Replacing the battery

Fig. 126 Vehicle key: battery compartment cover

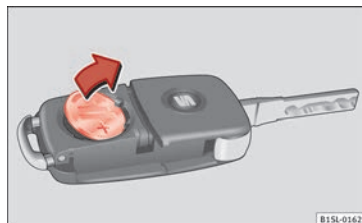


Fig. 127 Vehicle key: removing the battery

SEAT recommend having the batteries changed in a specialised workshop.

The battery is located to the rear of the vehicle key, under a cover »» **Fig. 126**.

When changing the battery, use another battery of the same model and observe the polarity when fitting it »» **ⓘ**.

To change the battery

- Unfold the vehicle key blade » page 112.
- Remove the cover from the back of the vehicle key » Fig. 126 in the direction of the arrow » ❶.
- Extract the battery from the compartment using a suitable thin object » Fig. 127.
- Place the new battery in the compartment, pressing in the direction of the arrow as shown » Fig. 127 » ❷.
- Fit the battery compartment cover, pressing in the direction of the arrow as shown » Fig. 126 until it clicks into place.


ⓘ CAUTION


- If the battery is not changed correctly, the vehicle key may be damaged.
- Use of unsuitable batteries may damage the vehicle key. For this reason, always replace the dead battery with another of the same voltage, size and specifications.

♻️ For the sake of the environment

- Please dispose of your used batteries correctly and with respect for the environment.
- The vehicle key battery may contain perchlorate. Observe the legal requirements for their disposal.


Synchronising the vehicle key

If the  button is pressed frequently outside of the vehicle range, it is possible that the vehicle can no longer be locked or unlocked using the key. In this case, the vehicle key must be synchronised once more as follows:

- Unfold the vehicle key blade » page 112.
- Remove the cover from the driver door handle » page 90.
- Press the  button on the vehicle key. For this, it must remain with the vehicle.
- Open the vehicle within one minute using the key shaft.
- Turn on the ignition using the vehicle key. The key has been synchronised.
- Replace the driver door handle cover.

Central locking and locking system

Introduction

Read the additional information carefully »  page 10

Central locking functions correctly when all the doors and the rear lid are correctly shut. If the driver door is open, the vehicle *cannot* be locked with the key.

If the vehicle has the Keyless Access closing and ignition system, it may only be locked with the ignition off and the driver's door closed.

The battery of an unlocked vehicle parked for a long period (e.g. in a private garage) may run down and fail to start the motor.

⚠️ WARNING

The incorrect use of the central locking system may cause serious injuries.

- The central locking system will lock all doors. A vehicle locked from the inside can prevent any non-authorized individual from opening the doors and accessing the vehicle. Nevertheless, in case of emergency or accident, locked doors will complicate access to the vehicle interior to help the passengers.
- Never leave children or disabled people alone in the vehicle. The central locking button can be used to lock all the doors from within. Therefore, passengers will be locked inside the vehicle. Individuals locked in the vehicle can be exposed to very high or very low temperatures.
- Depending on the time of the year, temperatures inside a locked and closed vehicle can be extremely high or extremely low resulting in serious injuries and illness or even death, particularly for young children.
- Never leave individuals locked in a closed and locked vehicle. In case of emergency, they may not be able to exit the vehicle by themselves or get help.

Description of the central locking system


The central locking system allows all doors and the rear lid to be locked and unlocked centrally.

- From outside, using the vehicle key.
- From outside with the Keyless Access system » page 117.
- From inside, by pushing the central locking button » page 116.

In the submenu **Convenience** in the **Configuration** menu, or by visiting a specialised workshop, special functions of the central locking system can be switched on or off » page 27.

In case of a vehicle key fault or central locking system fault, all doors can be locked or unlocked manually.

Automatic locking (Auto Lock)


In this instance, the vehicle locks automatically when moving at speeds above approx. 15 km/h (10 mph) » page 27. When the vehicle is locked, the  control lamp on the central locking button lights up in yellow » Fig. 129.

Automatic unlocking (Auto Unlock)

When the key is removed from the ignition slot, here the vehicle unlocks all doors and the boot automatically » page 27.

Locking the vehicle after the airbags have been deployed

If the airbags are deployed due to an accident, the vehicle will be automatically and completely unlocked. Depending on the amount of damage, it can be locked following an accident in the following ways:

Function	Action
Lock the vehicle by pushing the central locking button:	<ul style="list-style-type: none"> – Switch off the ignition. – Open a door of the vehicle and close it again. – Push the central locking button .
Lock the vehicle with the vehicle key:	<ul style="list-style-type: none"> – Disconnect the ignition button. OR: remove the key from the ignition. – Open a door once. – Lock the vehicle with the key.

Note



If the vehicle key buttons are pressed » Fig. 128 or one of the central locking buttons is pressed » Fig. 129 several times in quick succession, the central locking feature is disabled briefly to protect from overloading. The vehicle will then remain unlocked for around 30 seconds. If no door nor the boot is


opened during this time, the vehicle will then automatically unlock.



Unlocking and locking the vehicle from outside



Fig. 128 Buttons on the vehicle key

Function	Handling the buttons on the vehicle
Unlocking the vehicle.	Press the  button. Keep it pushed for the convenience opening.
Lock the vehicle.	Press the  button. Keep it pushed for the convenience locking function.

Function	Handling the buttons on the vehicle
Unlocking the rear lid.	Press the  button.
Open the sliding door.	»» page 122.

Please note: depending on the central locking function selected in the **Convenience** submenu, you may have to push the  button twice »»  page 27 to unlock all doors and the rear lid.

The vehicle key only locks and unlocks the vehicle if it is within range of the vehicle and if the batteries have enough power. When locking, the vehicle's turn signals will blink.

If the driver door is open, the vehicle cannot be locked with the key. If you unlock the vehicle without opening any doors or the rear lid, it will lock again automatically after a few seconds. This function prevents the vehicle from remaining unlocked if the unlocking button is pressed by mistake.

Convenience open/close function



- See »» page 127, **Controls for the windows: functions.**
- See »» page 129, **Panoramic sliding sunroof: operating.**

Unlocking and locking the vehicle from inside



Fig. 129 In the driver door: central locking button

Push the button »» Fig. 129:

-  Unlocking the vehicle.
-  Locking the vehicle.

The central locking button is still operative when the ignition is switched off.

The central locking button is only deactivated if the Safe security system is activated »» page 119.

Please note the following when you use the central locking button to lock your vehicle:

- **Do not** turn on the Safe security system »» page 119.
- **Do not** turn on the anti-theft alarm.

- It will not be possible to open the doors or the rear lid from the *outside*. This may offer extra safety, for example when stopped at traffic lights.
- The doors can be opened and unlocked individually from the inside by pulling the door handle. If necessary, pull the door release lever twice.
- The driver door cannot be locked when open. This avoids locking the vehicle key inside the vehicle when there is nobody inside.

Locking and unlocking the vehicle with Keyless Access

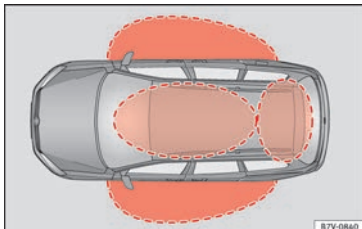


Fig. 130 Keyless Access locking and ignition system: in the proximity of the car.

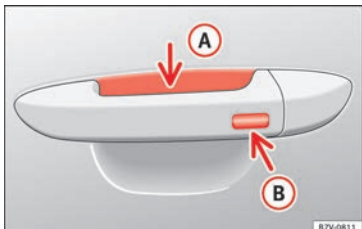


Fig. 131 Keyless Access locking and ignition system: sensor surface **A** for unlocking inside the door handle and sensor surface **B** for locking on the exterior of the handle.

Keyless Access is a key-free locking and ignition system to unlock and lock the vehicle without actively using its key. For this, only a

valid vehicle key is required to be in an area near **» Fig. 130** the vehicle and one of the sensor surfaces to be touched on the door handles **» Fig. 131**.

General information

If a valid key is located in the proximity of the car **» Fig. 130**, the Keyless Access lock and ignition system gives the key entry as soon as one of the sensor surfaces on the door handles is touched or the push button on the boot hatch is operated. The following features are then available without having to use the vehicle key actively:

- Keyless-Entry: unlocking of the vehicle with the handles on the four doors or the button located on the boot hatch.
- Keyless-Go: engine ignition and driving. For this to occur, there has to be a valid key inside the vehicle and the ignition push button needs to be pressed **» page 183**.
- Keyless-Exit: unlocking of the vehicle with one of the four door handle.

The central locking and locking systems operate in the same way as a *normal* locking and unlocking system. Only the controls change.

Unlocking the vehicle is confirmed with a *double* flash of the indicator lights; locking by a *single* flash.

The vehicle will lock again after a few seconds if you unlock the vehicle but fail to open any door or boot hatch.

Unlocking and opening the doors (Keyless-Entry)

- Grip the door handle. In doing this, the sensor surface **» Fig. 131 A** (arrow) is touched on the handle and the vehicle unlocks.
- Open the door.

On vehicles without the Safe security system: shutting and locking doors (Keyless-Exit)

- Switch the ignition off.
- Close the driver's door.
- Touch the surface sensor **B** *once* (arrow) on the door handle. The door being operated must be closed.

On vehicles with the Safe security system: shutting and locking doors (Keyless-Exit)

- Switch the ignition off.
- Close the driver's door.
- Touch the surface sensor **B** *once* (arrow) on the door handle. The vehicle locks with the Safe security system **» page 119**. The door being operated must be closed.

- Touch *the sensor surface* **(B)** twice (arrow) on the door handle to lock the vehicle without the Safe security system » **page 119**.

Unlocking and locking the boot hatch


When the vehicle is locked, the hatch automatically unlocks on opening if » **Fig. 130** there is a valid vehicle key in the proximity.

Open or close the hatch *normally* » **page 124**.

After closing, the hatch locks automatically. In the following instances, the rear lid does **not** lock automatically after closing:

- If the entire vehicle is unlocked.
- If the key used last is inside the vehicle. All vehicle indicator lights flash *four times*. The vehicle will lock again after a few seconds if no door or boot hatch are opened.

Locking the vehicle with a second key

If there is a vehicle key inside the vehicle and it is locked from the outside with a second vehicle key, the key inside the vehicle is blocked for engine ignition » **page 183**. In order to enable engine ignition, the  button on the key inside the vehicle needs to be pressed » **Fig. 128**.


Automatically disabling sensors

If the vehicle is not locked or unlocked for a long period of time, the proximity sensor on

the passenger door is automatically disabled.


If the exterior sensor on the door handle is often activated unusually with the vehicle locked (e.g. by the branches of a bush rubbing against it), all proximity sensors are disabled for a time. If this only happens with the exterior sensor on the driver's door, only this sensor is disabled.

Sensors will again be enabled:

- After a time.
- **OR:** if the vehicle is unlocked with the  button on the key.
- **OR:** if the boot is opened.

Keyless Access temporary disconnection function*

You can deactivate the vehicle's Keyless Access unlocking for a locking and unlocking cycle.

- Move the gear lever to position **P** (if the vehicle has automatic gearbox), since otherwise the vehicle cannot be locked.
- Close the door.
- Push the central locking button  on the remote control and touch the locking sensor surface » **Fig. 131 (B)** on the driver door handle once within the following 5 seconds. Do not grip the door handle, otherwise the vehicle will not lock. Deactivation is also possible


if the vehicle is locked through the driver's door lock.

- To check that the function has been deactivated, wait at least 10 seconds, grip and pull on the door handle. The door should not open.

The next time the door can only be unlocked via the remote control or the lock cylinder. The next time the door is locked/unlocked, Keyless Access will be active again.

Convenience functions

To **close** all electric windows, the sun roof and electric tilting panoramic roof with the convenience feature, keep your finger for a few seconds on the lock sensor surface **(B)** located on the exterior part of the driver or passenger door handle until the windows and roof close.

Opening the doors by touching the sensor surface on the handle takes place in accordance with the settings activated on the menu **Configuration - Convenience** »  **page 27**.

CAUTION




The sensor surfaces on the door handles could engage if hit with a water jet or high pressure steam if there is a valid vehicle key in the nearby area. If at least one of the windows is open and the sensor surface **(B)** on one of the handle permanently activates, all

windows will close. If the water jet or steam is briefly moved away from the sensor surface **A** on one of the handles and then pointed at it again, all the windows will probably open » page 118, Convenience functions.

Note

- If the vehicle battery has little or no charge, or the vehicle key battery is almost or entirely out of charge, it is likely that the vehicle will not be able to be lock or unlocked with the Keyless Access system. The vehicle can be unlocked or locked manually » page 90.
- If there is no valid key inside the vehicle or the system fails to detect one, a warning will display on the dash panel screen. This could happen if any other radio frequency signal interferes with the key signal (e.g. from a mobile device accessory) or if the key is covered by another object (e.g. an aluminium case).
- If the sensors are very dirty, e.g. have a layer of salt, how the sensors on the door handles operate may be affected. If this is the case, wash the vehicle » page 253.
- If the vehicle is equipped with an automatic gearbox, it may only be locked in the gear stick is in position P.


Safe security system

Function	Necessary operations
Lock the vehicle and activate the "Safe" security system.	Press the  button <i>once</i> on the vehicle key.
Lock the vehicle without activating the "Safe" security system.	Press the  button <i>twice</i> on the vehicle key.
	Touch the Keyless Access close and ignition lock sensor surface located on the exterior or part of the door handle <i>twice</i> » page 117.
	Press the central locking button  on the driver door once.

Depending on the vehicle, when switching the ignition off, a warning may be displayed on the dash panel screen stating that the Safe security system is activated (**SAFE Lock** or **SAFELOCK**).

Disabling the Safe security system

The Safe security system may be disabled in any of the following ways:

- Press the  button on the vehicle key *twice*.
- Touch the Keyless Access close and ignition lock sensor surface located on the exterior or part of the door handle *twice* » page 117.

- Switch the ignition on.
- Press the ignition push button of the Keyless Access lock and ignition system.

When the "safe" security system is disabled, the following needs to be taken into account:

- The vehicle can be opened and unlocked from the inside using an inside door handle.
- The anti-theft alarm is activated.
- The vehicle interior monitoring system and the anti-tow system are disabled.

WARNING

Careless use of the "Safe" security system can cause serious injury.

- **Never leave anybody inside the vehicle if it has been locked using the key. When the Safe security system is activated, the doors cannot be opened from the inside!**
- **When the doors are locked, it is difficult to get to passengers in the vehicle interior in case of an emergency. Passengers could remain trapped inside and unable to unlock the doors in case of an emergency.**

Anti-theft alarm

The anti-theft alarm makes it more difficult to break into the vehicle or steal it.

The anti-theft alarm is automatically turned on when the vehicle is locked with the key. »

When does the system trigger an alarm?

The anti-theft alarm siren will be triggered for about 30 seconds accompanied by optical warning signals for about five minutes when the vehicle is locked and the following unauthorised actions are taken:


- When the door is mechanically unlocked using the vehicle key without turning the ignition within the following 15 seconds.
- A door is opened.
- The bonnet is opened.
- The rear lid is opened.
- When the ignition is switched on with a non-authorized key.
- When the vehicle battery is disconnected.
- When there is movement inside the vehicle (vehicles with interior monitoring).
- When the vehicle is towed (vehicles with anti-tow system)
- When the vehicle is lifted (vehicles with anti-tow system).
- Transporting the vehicle on a ferry or by railroad (vehicles with an anti-tow system or interior monitoring).
- Unhitch a trailer connected to the anti-theft alarm »» page 237.

How to turn OFF the alarm

Unlock the vehicle with the unlocking button on the key or turn on the ignition with a valid

key. On vehicles with the Keyless Access system, the alarm can also be disabled by grasping the door handle »» page 117.

Note

- The alarm will be triggered once more when anybody enters the same zone of surveillance or any other zone. If, for example, after opening a door, the rear lid is also opened.
- The anti-theft alarm is not activated when the vehicle is locked from within using the central locking button .
- If the driver door is unlocked mechanically with the key, only the driver door is unlocked, the rest of the doors remain locked. Only when the ignition has been turned on will the other doors be available - but not unlocked - and the central locking button will be activated.
- If the vehicle battery is run down or flat then the anti-theft alarm will not operate correctly.

Vehicle interior monitoring system and anti-tow system*

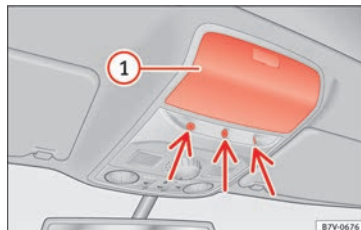



Fig. 132 On the roof console: interior monitoring sensors


The interior monitoring system triggers the alarm if the vehicle is locked and movement is detected inside the vehicle. The anti-tow system triggers the alarm if the vehicle is locked when the system detects the vehicle is being raised.

Switching on the interior monitoring and the anti-tow systems

Close the storage compartment »» **Fig. 132**  on the roof console, otherwise the interior monitoring function (arrow) is not guaranteed to work freely.


Use the key to lock the vehicle. If the anti-theft alarm is turned on, the interior monitoring and the anti-tow systems are also activated.

Switching off the interior monitoring and the anti-tow systems

The vehicle interior monitoring is switched off by pressing the remote control lock button  twice.

- Lock all doors and rear lid.
- Use the key to lock the vehicle. The interior monitoring and / or anti-towing alarm are switched off until the next time the vehicle is locked.

To turn off the interior monitoring and anti-tow systems before unlocking the vehicle, for example in the following situations:

- When leaving animals inside the vehicle  **»» page 114.**
- When the vehicle must be loaded.
- When the vehicle is being transported, for example, by ferry.
- When the vehicle must be towed with the axle raised.

Risk of false alarms

The interior monitoring system will only operate correctly if the vehicle is completely closed. Observe legal requirements. The alarm may be accidentally triggered in the following cases:

- When a window is completely or partially open.

- If the sunglasses storage compartment in the roof console is open.
- When the panoramic sliding sunroof is completely or partially open.
- When suspended objects are hung from the interior mirror (air freshener) or there are loose papers in the vehicle.
- If the separation net is fitted and moves (due to heating).
- Due to a vibrating mobile telephone inside the vehicle.

Note

Upon activating the alarm, if any door or the rear lid is open, only the anti-theft alarm will be activated. The interior monitoring and anti-tow systems will only be activated when the doors and rear lid are fully closed.

Doors

Introduction

WARNING

If a door is not correctly closed, it could open unexpectedly when driving and cause serious injuries.

- **Always stop immediately and close the door.**



- **When closing, ensure that the door has closed correctly. A closed door should be flush with the corresponding parts of the bodywork.**
- **Open and close doors only when nobody is in the way of the door.**

WARNING



A door held open by its retainer could be blown closed by the wind or close if the vehicle is on a hill, causing injury.

- **When opening and closing doors, always use the door handle.**

Warning lamp

	It lights up
At least one vehicle door is open or not correctly shut.	 Stop driving immediately! Open the corresponding door and close it immediately.

Several warning and control lamps light up for a few seconds when the ignition is switched on, signalling that the function is being verified. They will switch off after a few seconds.

If a door is open or not properly closed, the warning lamp  or  will light up on the instrument panel.

Depending on the vehicle equipment, a symbol may be displayed on the dash panel **»**

screen instead of the warning lamp. The indication is also visible when the ignition is switched off. The indication disappears around 15 seconds after the vehicle has been locked.

Sliding doors

Introduction

⚠ WARNING

If a sliding door is not correctly closed, it could open unexpectedly when driving and cause serious injuries.

- Stop immediately and close it.
- When closing, ensure that the sliding door has closed correctly. A closed sliding door should be flush with the corresponding parts of the bodywork.
- Only open and close sliding doors when no body is in the way of the door.

⚠ WARNING

If a sliding door is not fully open, it could close unexpectedly and cause serious injuries.

- Always open the sliding door fully.

⚠ WARNING

Opening sliding doors while driving is dangerous. These doors may be pushed open or closed when the vehicle accelerates or brakes and cause serious injuries.

- Never open the sliding doors when the vehicle is in movement.

Manually opening and closing the sliding door

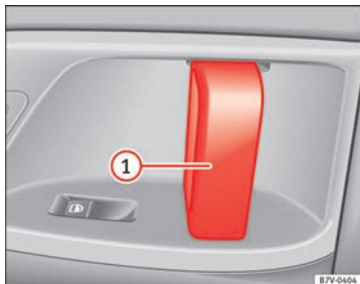


Fig. 133 On the sliding door, door handle ①.

Function	Necessary operations
Open the sliding door from the inside.	When the sliding door is released, open the door fully by pulling on the outside handle.

Function	Necessary operations
Opening the sliding door from the inside.	When the sliding door is released, open the door fully by pulling on its interior handle » Fig. 133 ①.
Closing the sliding door.	Pull on the inside or outside door handle and close the sliding door, pushing it gently. Make sure that it is completely closed.

Electric opening and closing of the sliding door*



Fig. 134 On the dash panel, on the remote control key and on the interior lining of the sliding door: button for opening and closing the electric sliding door.


All of the electric sliding doors can be opened and closed manually using more force.

Function	Necessary operations
Opens the sliding door electrically.	Press the »» Fig. 134 button on the dash panel, on the remote control key and on the interior lining of the sliding door. The sliding door opens with the rollback anti-trap function as long as the button is not pressed again.
	Pull briefly on the interior or exterior door handle. The sliding door opens automatically.
Closing the sliding door electrically.	Press the »» Fig. 134 button on the dash panel, on the remote control key and on the interior lining of the sliding door. The sliding door closes with the rollback anti-trap function as long as the button is not pressed again. As it closes, a warning sound is given.
	Pull briefly on the interior or exterior door handle. The sliding door closes with the roll-back function. As it closes, a warning sound is given.

Note

- When the fuel tank flap is open, the right-hand side electric sliding door is locked and can only be opened manually.
- If the window of a sliding door is lowered them this door cannot open fully.

Rollback anti-trap function of the electric sliding doors


The rollback anti-trap function of the electric sliding doors can reduce the risk of injury when opening and closing the sliding doors **»»** .

If an object gets in the way of the sliding door while it is *closing*, it will open again.

If an object gets in the way of the sliding door while it is *opening*, the door will be immobilised at this point.

- Check the reason for which the sliding door does not open or close.
- Try to open or close the sliding door again.

To close the sliding door without the rollback anti-trap function

- Turn off the ignition and turn it on again.
- Press and hold the  button **»» Fig. 134**. The sliding door closes with full force.

WARNING

Closing the electric windows without the anti-trap function can cause serious injury.

- Always close the sliding doors carefully.
- Nobody should ever get in the way of the electric sliding doors, especially when closing without the anti-trap function.

- The anti-trap function does not prevent fingers or other parts of the body getting pinched against the window frame and causing injury.

Electric child safety lock

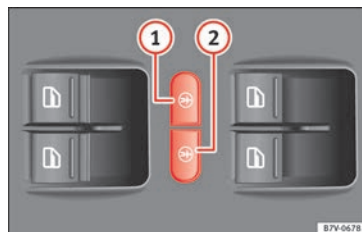




Fig. 135 In the driver door: electric child safety locks buttons

The electric child safety lock avoids opening and locking of the sliding door and its electric windows from the inside so that children cannot accidentally open the door while the vehicle is being driven. Using the left-hand **»» Fig. 135**  or right-hand side  button, the childproof lock is activated on the left- or right-hand side respectively. **»»**

Turning on and off the electric child safety

Function	Necessary operations
To switch system on:	Press the button » Fig. 135 ① or ②.
To switch system off:	Press the button again.

The yellow control lamp ① indicates that the feature is on for the corresponding button.

 **WARNING**

When the electric child safety function is activated, the sliding door can be opened from the outside only.

- Never leave children or disabled people alone in the vehicle if the doors are to be locked. Therefore, passengers will be locked inside the vehicle. They could be trapped in the car in an emergency and will not be able to get themselves to safety. Individuals locked in the vehicle can be exposed to very high or very low temperatures.
- Depending on the time of the year, temperatures inside a locked and closed vehicle can be extremely high or extremely low resulting in serious injuries and illness or even death, particularly for young children.

Rear lid

Introduction

Read the additional information carefully

»  page 12

 **WARNING**

Careless and unsuitable locking, opening and closing of the rear lid can cause accidents and serious injury.

- Open and close the rear lid only when nobody is in the way.
- Do not close the rear lid by pushing it down with your hand on the rear window. This could break and cause injury.
- Ensure the rear lid is locked after closing, otherwise, it may open unexpectedly while driving. A closed rear lid should be flush with the corresponding parts of the bodywork.
- Always keep the rear lid closed while driving to avoid toxic gases entering the vehicle interior.
- Do not open the rear lid when there is a load carrier installed. Likewise, the boot hatch cannot be opened when a load is attached to it, for example bicycles. An open rear lid could close itself if there is an additional weight on it. If necessary, press down on the rear lid and remove the load.
- Close and lock both the rear lid and all the other doors when you are not using the vehi-

cle. Ensure that nobody remains inside the vehicle.

- Never allow children to play inside or around the vehicle without supervision, especially if the rear lid is open. Children could enter the luggage compartment, close the rear lid and become trapped. Depending on the time of the year, temperatures inside a locked and closed vehicle can be extremely high or extremely low resulting in serious injuries and illness or even death, particularly for young children.
- Never leave children or disabled people alone in the vehicle. If the vehicle key or the central locking button is used, they may be locked in the vehicle.

 **WARNING**

Unsuitable or careless unlocking and opening of the rear lid could cause serious injuries.

- If there is a loaded luggage carrier on the rear lid, it could be unlocked or open but not recognised as such. An unlocked or open rear lid could open unexpectedly while driving.


 **CAUTION**

Before opening the rear lid, ensure that there is sufficient free space to open and close it, for example if you are towing a trailer or in a garage.

Warning lamp

	It lights up
The rear lid is open or not correctly shut.	Stop driving immediately! Open the rear lid and close it again.

Several warning and control lamps light up for a few seconds when the ignition is switched on, signalling that the function is being verified. They will switch off after a few seconds.

The  warning lamp appears on the dash panel if the rear lid is open or not properly closed.

Depending on the vehicle equipment, a symbol may be displayed on the dash panel instead of the warning lamp. The indication is also visible when the ignition is switched off. The indication disappears around 15 seconds after the vehicle has been locked.

WARNING

If the rear lid is not correctly closed, it could open unexpectedly when driving and cause serious injuries.

- Always stop immediately and close the rear lid.
- Ensure that the rear lid has been locked in to place by the element on the lock carrier when you close it.

Note

At outside temperatures of less than 0°C (+32°F), the pressurised gas struts cannot always automatically lift the rear lid. In this case, open the rear lid manually.

Closing the rear lid



Fig. 136 Rear lid open: hand grip

Closing the rear lid


- Grab the handgrip inside the rear lid
»» Fig. 136 (arrow).
- Push the rear lid downwards until it locks into place in the lock.
- Ensure that it is correctly closed by pulling on it firmly.

Locking the rear lid

If you unlock the vehicle without opening any doors or the rear lid, it will lock again auto-

matically after 30 seconds. This function prevents the vehicle from remaining unlocked if the unlocking button is pressed by mistake.

Locking is only possible when the rear lid is correctly and fully closed.

- The rear lid is also locked by a central locking.
- If the vehicle rear lid is locked or unlocked using the  button of the vehicle key, when it is closed again it will lock automatically.
- A closed but not locked rear lid will lock automatically at a speed above about 9 km/h (7 mph).

WARNING

Unsuitable or careless closing and locking of the rear lid could cause serious injuries.

- Never leave the vehicle unattended, or allow children to play inside or around the vehicle without supervision, especially if the rear lid is open. Children could enter the luggage compartment, close the rear lid and become trapped. A locked vehicle can be subjected to extremely high and low temperatures, depending on the time of year, thus causing serious injuries/illness and even death.

Note

Before closing the rear lid, make sure that the key has not been left inside the luggage compartment.

Opening the rear lid electronically



Fig. 137 Button with rear lid open

Opening the rear lid

- Press and hold the button on the vehicle key until the rear lid opens automatically.
- **OR:** press and hold the button on the centre console for approximately 1 second **Fig. 6**.
- **OR:** press the **Fig. 7** boot hatch button (arrow).

In case of difficulty or obstruction, automatic opening of the rear lid is interrupted.

Electronically opening the rear lid does not work when a trailer is electrically connected and hitched to a factory fitted tow hitch **page 237**.

The rear lid can be opened manually by applying more force.

Closing the rear lid

- Press and hold the button on the vehicle key for approximately 1 second.
- **OR:** press and hold the button on the centre console for approximately 1 second **Fig. 6**.
- **OR:** press the **Fig. 7** boot hatch button (arrow).
- Press the button on the open rear lid **Fig. 137** .
- Manually push the rear lid down to close it.

The rear lid will move down to the closed position to close and lock itself automatically using the power-close feature **Fig. 137** .

In case of difficulty or obstruction, automatic closing of the rear lid is interrupted and it will open slightly.

Check why the rear lid could not close.

Attempt to close it once more.

Interrupting the opening and closing process

Rear lid opening and closing can be stopped by pressing one of the buttons. Each time one of the buttons is pressed, the rear lid moves to its initial position.

Then, it can be opened or closed by hand. To do this, apply a little more force.

Memorising the opening angle

The rear lid must be at least half open to memorise an opening angle.

- Stop automatic opening in the opening position required **page 126**.
- Hold down the button **Fig. 137** with the rear lid open for at least three seconds. The opening angle is memorised.

Memorisation is confirmed by blinking of the hazard warning lights and an audible warning.

To fully open the boot hatch again, the opening angle must be memorised once more.

- Release the rear lid and open it to the memorised height.
- Push the rear lid all the way up. To do this, apply a little more force.
- Hold down the button **Fig. 137** with the rear lid open for at least three seconds.
- The opening angle is reset to the original factory setting.

WARNING

Unsuitable or careless closing and locking of the rear lid could cause serious injuries.

- **Never leave the vehicle unattended, or allow children to play inside or around the vehicle without supervision, especially if the rear lid is open. Children could enter the luggage**

compartment, close the rear lid and become trapped. A locked vehicle can be subjected to extremely high and low temperatures, depending on the time of year, resulting in serious injuries/illness or even death.

WARNING

It is possible that the rear lid does not open completely or, if it is open, closes alone if a large amount of snow has built up on it or if a luggage rack is fitted. In this case, the rear lid must be supported.

CAUTION

- When using a trailer, ensure that there is sufficient space to open and close the rear lid.
- Before opening the rear lid, any kind of equipment carrier should be removed, for example a bicycle carrier.

CAUTION

In case of repeated short-term use, the system is turned off to avoid overheating.

- When it has cooled, it may be used once again. During this time, the rear lid may be manually opened or closed applying a little more effort.
- If the vehicle battery is disconnected or the fuse blows when the rear lid is open, the rear lid system must be re-initialised. To do this, close the rear lid.

Note

Before closing the rear lid, make sure that the key has not been left inside the luggage compartment.

Controls for the windows

Controls for the windows: functions

Read the additional information carefully

»  page 13

After turning off the ignition, the windows can be opened and closed for a short time using the buttons on the door as long as the driver door or passenger side door is not open. When the key is removed from the ignition and the driver door is open, all of the electric windows can be opened or closed at the same time keeping the button on the driver's door pressed down. After a few seconds, the convenience opening or closing function will begin » page 127.

One-touch opening and closing

The one-touch automatic opening and closing is used to open or close the windows completely. It will not be necessary to hold the button of the corresponding electric window.

For the one-touch closing function: pull the button for the corresponding window upwards until it reaches the second position.

For the one-touch opening function: push the button for the corresponding window downwards until it reaches the second position.

To stop the one touch function: push or pull on the button of the corresponding window.

Resetting one-touch opening and closing

The one-touch opening and closing function is not active after the vehicle battery has been disconnected or is flat and will have to be reset.

- Close all windows and doors.
- Pull the button of the corresponding window and hold it for one second in this position.
- Release the button and pull upwards and hold again. The one-touch function is now ready for operation.


The automatic one-touch electric windows can be reinitialised individually or several at a time.

Convenience opening/closing

The electric windows can be opened or closed from outside using the vehicle key: »

- Keep the vehicle unlocking or locking button pressed. All windows which function electrically will be either opened or closed.
- To interrupt the function, release the locking or unlocking button.

During convenience closing, first the windows and then the sliding sunroof will be closed.

In the **Configuration – convenience** menu, there are different settings for operating the windows »  page 27.

WARNING



Careless use of the electric windows can cause serious injury.


- Only operate the electric windows when nobody is in the way.
- Never leave children or disabled people alone in the vehicle if the doors are to be locked. The windows cannot be opened in case of an emergency.
- Always take all the keys with you whenever you leave the vehicle. After turning off the ignition, the windows can be opened and closed for a short time using the buttons on the door as long as the driver door or passenger side door is not open.
- When transporting children in the rear seats, always deactivate the rear electric windows with the child safety lock so that they cannot be opened and closed.

Note

The one-touch function and roll-back function will not work if there is a malfunction in the electric windows. Visit an authorised workshop.

Roll-back function on electric windows

The anti-trap function of the electric windows can reduce the risk of injury when opening and closing the electric windows »  . If a window is not able to close because it is stiff or because of an obstruction, it will automatically open again.

- Check why the window does not close.
- Attempt to close the window again.
- If you try within the following 10 seconds and the window closes with difficulty or there is an obstruction once again, the one-touch closing will stop working for 10 seconds.
- If the window is still obstructed, it will stop at the corresponding position. When the button is operated within 10 seconds, the window will close **without the anti-trap function** » .

To close windows without the anti-trap function

- Attempt to close the corresponding electric window within 10 seconds after by holding the button. **The window is closed without the anti-trap function, deactivated for a short time.**
- After more than 10 seconds, the anti-trap function is reactivated. The window will stop once again if there is another difficulty or obstacle.
- If the window will still not close, visit a specialised workshop.

WARNING

Closing the electric windows without the anti-trap function can cause serious injury.

- Always close the electric windows carefully.
- Nobody should be in the way of the electric windows, especially when the anti-trap function is deactivated.
- The anti-trap function does not prevent fingers or other parts of the body getting pinched against the window frame and causing injury.

Note

The anti-trap function also operates if the windows are closed from the outside of the vehicle using the ignition key for convenience closing » page 127.

Panoramic sliding sunroof*

Panoramic sliding sunroof: operating

Read the additional information carefully

»  page 14

The panoramic sliding sunroof will only work with the ignition on. It can be opened or closed for a few minutes after the ignition has been switched off, provided the driver door and the front passenger door are not opened.

Convenience open/close function

The panoramic sliding sunroof can be opened or closed from outside the vehicle using the vehicle key:

- Keep the vehicle unlocking or locking button pressed. The panoramic sliding sunroof is adjusted or closes.
- Release the unlock or lock button to stop the function.

During convenience closing, first the windows and then the panoramic sliding sunroof will be closed.

WARNING

Careless or uncontrolled use of the panoramic sliding sunroof can cause serious injuries.

- Only close the panoramic sliding sunroof and the sun blind when nobody is in the way.
- Always take all the keys with you whenever you leave the vehicle.
- Never leave children or disabled persons in the vehicle, particularly if they have access to the keys. Uncontrolled use of the key could lock the vehicle, start the engine, turn on the ignition and operate the panoramic sliding sunroof.
- The panoramic sliding sunroof can be operated for up to about ten minutes after the ignition has been switched off, provided the driver door and the front passenger door are not opened.

Note

- In case of a fault in the operation of the panoramic sliding sunroof, the anti-trap function will not operate correctly. Visit a specialised workshop.
- The rotary button of the panoramic sliding sunroof remains in the last position selected if the roof is closed using convenience closing from outside the vehicle, and will have to be re-positioned the next time you drive.

Opening or closing the sun blind

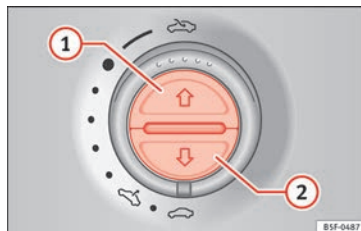



Fig. 138 On the interior roof lining: switches for the sun blind

Function	Necessary operations
To open completely (automatic):	Press button » Fig. 138 ① briefly.
To stop automatic operation:	Briefly press the button » Fig. 138 ① » Fig. 138 ②.
To set the intermediate position:	Hold the button » Fig. 138 ① or » Fig. 138 ② until the required position is reached.
To close completely (automatic):	Press button » Fig. 138 ② briefly.






The panoramic sliding sunroof can be operated for up to about ten minutes after the ignition has been switched off, provided the driver door and the front passenger door are not opened.

Anti-trap function of the panoramic sliding sunroof and the sun blind

The anti-trap function reduces the risk of injury when opening and closing the panoramic sliding sunroof and sun blind » . When they encounter an obstacle while closing, they reopen.

- Check why the panoramic sliding sunroof or the sun blind did not close.
- Attempt to close the panoramic sliding sunroof or sun blind once again.
- If the panoramic sliding sunroof or sun blind is still obstructed, it will stop at the corresponding position. Close it without the anti-trap function.

Closing without the roll-back function

- The switch »  **Fig. 13** should be in the “closed” position .
- *Panoramic sliding sunroof*: within five seconds of triggering the anti-trap function, pull the control all the way back »  **Fig. 13** (arrow ) until the panoramic sliding sunroof closes fully.
- *Sun blind*: Within 5 seconds of triggering the anti-trap function, push button » **Fig. 138**  until the sun blind closes completely.
- **The panoramic sliding sunroof or sun blind closes without the anti-trap function.**

- If the panoramic sliding sunroof still cannot be closed, visit a specialised workshop.

WARNING

Closing the panoramic sliding sunroof or sun blind without the anti-trap function can cause serious injuries.

- **Always close the panoramic sliding sunroof carefully.**
- **Nobody should be in the way of the panoramic sliding sunroof or sun blind, especially when they are closed without the anti-trap function.**
- **The anti-trap function does not prevent fingers or other parts of the body getting pinched against the window frame and causing injury.**





Note


The anti-trap function is activated if the windows and the panoramic sliding sunroof are closed from the outside of the vehicle using the ignition key for convenience closing » page 127.

Lights and visibility

Lights

Control lamps

	It lights up
Driving light totally or partially faulty.	Replace the corresponding bulb » page 92. If all the bulbs are OK, the vehicle should be taken to a specialised workshop if necessary.
Fault in adaptive light.	» page 132.
	Flashes
Fault in the adaptive light system.	Contact a specialised workshop » page 132.
	It lights up
Rear fog light switched on.	» page 25.
	It lights up
Front fog lights switched on	» page 25.


	It lights up
Left or right turn signal. The control lamp flashes twice as fast when a vehicle or trailer turn signal is faulty.	If necessary, check the vehicle and trailer lighting.

	It lights up
Main beam on or flasher on.	»» page 131.


	It lights up
Headlight adjustment (Light Assist) on.	»» page 132.

Several warning and control lamps light up for a few seconds when the ignition is switched on, signalling that the function is being verified. They will switch off after a few seconds.

WARNING

Observe the safety warnings »»  in Control and warning lamps on page 107.

Switching lights on and off


Read the additional information carefully
»»  page 25

The driver is personally responsible for the correct use and adjustment of the lights in all situations.

In vehicles with **tow hitch** fitted as standard: if the trailer is connected electrically and is fitted with a rear fog light, the vehicle's fog light is automatically switched off.

Audible warnings to advise the driver that the lights have not been switched off

If the key is not in the ignition and the driver door is open, an audible warning signal is heard in the following cases: this is a reminder to turn off the lights.

- When the parking light is on »» page 131.
- When the light switch is in position .

WARNING

The side lights or daytime driving lights are not bright enough to illuminate the road ahead and to ensure that other road users are able to see you.

- Always use your dipped beam head lights if it is raining or if visibility is poor.

WARNING


If the headlights are set too high and the main beam is not used correctly, there is a risk of dazzling or distracting other road users. This could result in a serious accident.

- Always make sure that the headlights are correctly adjusted.
- Never use the main beam or headlight flasher when it can dazzle others on the road.

Note


The legal requirements regarding the use of vehicle lights in each country must be observed.

Turn signal and main beam lever

Read the additional information carefully
»»  page 26

Convenience turn signals

For the one-touch signalling, when the ignition is switched on, move the lever as far as possible upwards or downwards and release the lever. The turn signal will flash three times.

The control turn signals are switched on and off from the menu **Lights & Visibility** on the instrument panel display »»  page 27. This function can be disconnected at a specialised workshop for those vehicles which do not have the menu **Lights & Visibility**.

Note

- If the convenience turn signals are operating (three flashes) and the other convenience turn signals are switched on, the active part stops flashing and only flashes once in the new part selected.
- The turn signal only works when the ignition is switched on. The hazard warning lights also work when the ignition is switched off » page 83.
- If a turn signal on the vehicle or trailer is faulty, the warning lamp flashes twice as fast as usual.
- The main beam headlights can only be switched on if the dipped beam headlights are already on.

Lights and visibility: functions

Parking light P

When the parking light is switched on, (right or left turn signal), the front side light and the rear light on the corresponding side of the vehicle stay lit. The parking lights will only work with the ignition off.

Daytime running lights

The daytime running lights reduce the risk of accidents by increasing the visibility of the vehicle. These are independent lights that are built into the headlights and come on

each time the ignition is turned on if the light switch is in position **AUTO** or **O**.

When the light switch is in position **AUTO**, a photo sensor automatically turns the instrument and switch lighting on and off.

Automatic dipped beam control AUTO

The automatic dipped beam control is merely intended as an aid and is not able to recognise all driving situations.

When the light switch is in position **AUTO**, the vehicle lights and the instrument panel and switch lighting switch on and off automatically in the following situations » ⚠:

Automatic switching on	Automatic switching off or switch to daytime running lighting
The photo sensor detects darkness, for example, when driving through a tunnel.	When adequate lighting is detected.
The rain sensor detects rain and activates the windscreen wipers.	When the windscreen wiper has been inactive for a few minutes.

Adaptive headlights (AFS)

The adaptive headlights only operate when the dipped beam is on and at speeds of over 10 km/h (6 mph). On bends, the adaptive headlights automatically improve lighting on the road ahead.

The adaptive headlights can be switched on and off from the infotainment system.

Static cornering lights

When turning slowly to change direction or going round a tight bend, the static cornering lights automatically come on. The static cornering lights only work at speeds of less than 40 km/h (25 mph).

The static cornering lights may be incorporated into the fog lights or the front headlights, depending upon the equipment.


⚠ WARNING

If the road is not well lit and other road users cannot see the vehicle well enough or at all, accidents may occur.

- The automatic dipped beam control (AUTO) only switches on the dipped beam when there are no changes in brightness, and not, for example when it is foggy.
- Never drive with daytime lights if the road is not well lit due to weather or lighting conditions. Daytime lights do not provide enough light to illuminate the road properly or be seen by other road users.
- The rear lights do not come on with the daytime driving light. A vehicle which does not have the rear lights on may not be visible to other drivers in the darkness, if it is raining or in conditions of poor visibility.


Headlight adjustment

Headlight adjustment (Light Assist)

The headlight adjustment automatically connects and disconnects these lights depending on the environmental and traffic conditions and on the speed, within the limitations of the system » . This is monitored by a sensor located on the inside of the windscreen, above the interior rear vision mirror.

The automatic headlight adjustment automatically switches on the lights depending on the vehicles travelling in front and in the opposite direction, and on other environmental and traffic conditions from an approximate speed of 60 km/h (37 mph) and turns them off again at speeds below approximately 30 km/h (18 mph).

Switching on and off

	Action
Switching on:	– With the ignition on, turn the lights control to the position AUTO and put the turn signal and main beam lever in the main beam position » page 131. When the headlight adjustment (automatic lights also) is activated, the warning lamp lights up in the dash panel display  .

Switching off:	– Disconnect the on button. – OR: turn the lights control to a different position to AUTO » page 131. – OR: place the turn signal and main beam lever in the headlight flasher or main beam position » page 131.
----------------	---------------------------------------------------------------------------------------------------------------------------------------------------------------------------------------------------------------------------------------------

The following conditions can cause the headlight adjustment to fail to turn off the main beam or fail to do so in time:

- On roads with insufficient lighting with very reflective signs
- If road users are insufficiently lit up, e.g. pedestrians or cyclists.
- On closed curves, when the traffic in the opposite direction is partially hidden, on pronounced slopes
- On roads with traffic in the opposite direction and with a central reservation barrier where the driver can see through gaps or over it e.g. lorry drivers.
- If the camera is damaged or if the power supply has been cut off
- In the event of fog, snow or heavy rain
- In the event of dust or sand storms
- If the windscreen is damaged by the impact from a stone in the camera's field of vision
- If the camera's field of vision is misted up, dirty or covered by a sticker, snow or ice.

WARNING

The greater comfort that the headlight adjustment provides (automatic also) must not cause you to take risks. The system is not a replacement for driver awareness.

- Always monitor the lights yourself and adjust them depending on the light, visibility and traffic conditions.
- The headlight adjustment (automatic also) may not correctly detect all situations and in certain situations may only provide limited function.
- If the windscreen is damaged or modifications are made to the vehicle lighting, this may harm the functioning of the headlight adjustment (automatic lights also), for example, if additional headlight are fitted.

Note

Main beam and flashed headlights can be turned on and off manually at any time with the turn signal and main beam lever » page 131.

“Coming home” and “Leaving home” function (guidance lights)

The “Coming home” function should be switched on manually. However the “Leaving home” function is automatically controlled by a photo sensor.



“Coming home”: necessary operations

To switch system on:	<ul style="list-style-type: none"> – Switch off the ignition. – Briefly flash the headlights for <i>approximately one second</i> » page 131. <p>The “Coming home” lighting comes on when the driver door is opened. The <i>delay in switching off the headlights</i> is counted from when the last door or boot hatch is closed.</p>
To switch system off:	<ul style="list-style-type: none"> – Automatically at the end of the delay period. – Automatically, if 30 seconds after coming on, a vehicle door or the boot hatch remains open. – When the light switch is turned to position 0. – When the ignition is switched on.

“Leaving home”: necessary operations


To switch system on:	<ul style="list-style-type: none"> – Unlock the vehicle when the light switch is in position AUTO and the photo sensor detects <i>darkness</i>.
To switch system off:	<ul style="list-style-type: none"> – Automatically, at the end of the delay period. – When the vehicle is locked. – When the light switch is turned to position 0. – When the ignition is switched on.

Lighting around the exterior mirrors

The lighting around the exterior mirrors illuminates the door area on entering and leaving the vehicles. It comes on when the vehicle is unlocked, when the vehicle door is

opened and when the “Coming home” or “Leaving home” function is switched on. If the equipment includes the light sensor, the lighting around the exterior mirrors only comes when it is dark.


Note

- **The time taken for the headlights to go off can be changed in the Lights & Visibility menu and the function can be switched on or off** »  page 27.
- **When the “Coming home” function is on, if the vehicle door is opened there is no audible warning signal to advise that the light is still on.**

Hazard warning lights





Fig. 139 In the centre of the dash panel: push button for hazard warning lights.

Read the additional information carefully
»  page 26

Always fulfil legal requirements for securing a broken down vehicle. In a number of countries it is now obligatory, for example, to turn on the hazard warning lights and use a reflective safety vest » page 83.

When being towed with the hazard warning lights on, a change in direction or traffic lane can be indicated as usual using the turn signal lever. The hazard lights will be interrupted temporarily.

If your vehicle breaks down:

1. Park the vehicle a safe distance from traffic and on suitable ground » .
2. Turn on the hazard warning lights with the  button » **Fig. 139**.
3. Connect the electronic parking brake » page 188.
4. Move the selector lever to its intermediate position or to **P** » page 193.
5. Stop the engine and remove the key from the ignition » page 183.
6. Have all occupants leave the vehicle and move to safely, for example behind a guard rail.
7. When leaving the vehicle, take all keys with you.
8. Place an emergency warning triangle to indicate the position of your vehicle to other road users.

9. Allow the engine to cool and check if a specialist is required.

If the hazard warning lights are not working, you must use an alternative method of drawing attention to your vehicle. This method must comply with traffic legislation.

⚠ WARNING

A faulty vehicle in traffic represents a risk of accident for the driver and for other road users.

- Stop the vehicle safely as soon as possible. Park the vehicle a safe distance from surrounding traffic to lock all the doors in case of an emergency. Turn on the hazard warning lights to warn other road users.
- Never leave children or disabled people alone in the vehicle if the doors are to be locked. In case of an emergency, passengers will be trapped inside the vehicle. Individuals locked in the vehicle can be exposed to very high or very low temperatures.

⚠ WARNING

The components of the exhaust system reach very high temperatures. This could cause a fire and considerable damage.


- Always park your vehicle so that no part of the exhaust system can come in contact with flammable materials (such as dried grass or fuel).

Note

- The vehicle battery will discharge and run down if the hazard warning lights remain on for too long (even with the ignition turned off).
- In some vehicles, the brake lights will flash when braking abruptly at speeds of approximately 80 km/h (50 mph) to warn vehicles travelling behind. If braking continues, the hazard warning lights system will automatically be turned on at a speed of less than approximately 10 km/h (6 mph). The brake lights remain lit. Upon accelerating, the hazard warning lights will be automatically turned off.

Adhesive strips for headlights or adjusting headlights

In those countries where vehicles drive on the other side of the road to the home country, the asymmetric dipped beam may dazzle drivers of oncoming vehicles. Therefore, when driving abroad, adhesive strips should be attached to the headlights or the headlights should be adjusted accordingly.

The direction of the headlights can be adjusted from the instrument panel, in the **Tourist Light** submenu of the **Configuration** menu »  page 31.

For those vehicles in which it is not possible to adjust the headlights from the menu, ad-

hesive strips are used to cover certain parts of the headlamp cover or the headlights may be adjusted at a specialised workshop. For further information, please refer to a specialised workshop. SEAT recommends visiting a technical service.

Note

Use of the **Tourist Light** option and the adhesives on the headlights is only allowed if they are to be used for a short period of time. To modify the direction of the headlights permanently, please take the vehicle to a specialised workshop. SEAT recommends visiting a technical service centre.

Headlight range control, lighting of the instrument panel and controls

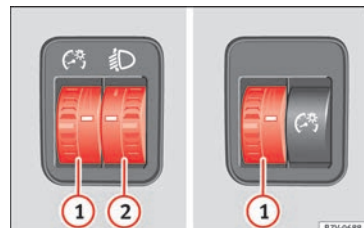


Fig. 140 Next to the steering wheel: instrument and switch lighting control ① and headlight range control ②

1 Instrument and switch lighting

When the headlights are switched on, the brightness of the instruments and switch lighting can be regulated by turning the switch »» Fig. 140 1.

2 Headlight range control

The headlight range control »» Fig. 140 2 is modified according to the value of the headlight beam and the vehicle load status. This offers the driver optimum visibility and the headlights do not dazzle oncoming drivers »» ⚠.

The headlights can only be adjusted when the dipped beam is switched on.

To reset, turn switch »» Fig. 140 2:

Value	Vehicle load status ^{a)}
–	Two front occupants, luggage compartment empty
1	All seats occupied, luggage compartment empty
2	All seats occupied, luggage compartment full. With trailer and minimum drawbar load.
3	Driver only, luggage compartment full With trailer and maximum drawbar load.

^{a)} If the vehicle load does not correspond to those shown in the table, it is possible to select intermediary positions.

Dynamic headlight range control

The control 2 is not mounted in vehicles with dynamic headlight range control. The headlight range is automatically adjusted according to the vehicle load status when they are switched on.

⚠ WARNING

Heavy objects in the back of vehicle may cause headlight dazzle and distract other drivers. This could result in a serious accident.

- Adjust the light beam to the vehicle load status so that it does not blind other drivers.

Interior and reading lights

Read the additional information carefully »» 📖 page 27

Storage and luggage compartment lighting

When the glove compartment and the rear lid are opened and closed, a light automatically switches on or off.

Ambient lighting

The ambient lighting in the front covering of the ceiling lights up the controls on the centre console from above when the side light or dipped beam lights are on.

In addition, the lever on the door moulding can also be illuminated.

Note

The reading lights go out when the vehicle is locked, or a few minutes after the key is removed from the ignition. This prevents the vehicle's battery from discharging.

Visibility

Sun visors

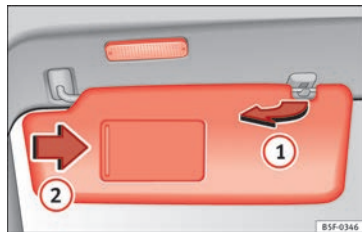


Fig. 141 Sun visor

Options for adjusting driver and front passenger sun visors:

- Lower the sun visor towards the windscreen.

• The sun visor can be pulled out of its mounting and turned towards the door »» Fig. 141 ①.

• Swing the sun visor towards the door, longitudinally backwards.

Vanity mirror light

There may be a vanity mirror, with a cover, on the rear of the sun visor. When the cover is opened »» Fig. 141 ② a light comes on.

The lamp goes out when the vanity mirror cover is closed or the sun visor is pushed back up.

⚠ WARNING

Sun visors and sun blinds may reduce visibility when open.

- Always roll or fold sun blinds and visors away when not in use.

📄 Note

The light above the sun visor automatically switches off after a few minutes in certain conditions. This prevents the battery from discharging.

Rear side window sun blinds

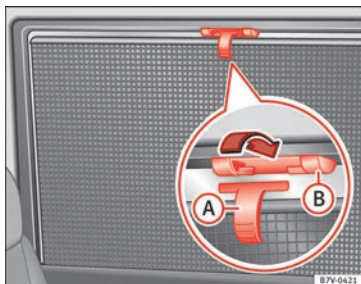


Fig. 142 On the rear right-hand window: sun blind

The sun blinds for the vehicle interior are fitted in the side panels of the windows.


- Pull the sun blind by the handle »» Fig. 142 A up to the top.
- Hook both rings of the fastening rod in the spaces provided B. Check that the sun blind is securely hooked into the spaces provided when it has been lowered B.
- To put the sun blind away, unhook it at the top and lower by hand »» ①.

⚠ CAUTION

To prevent damage to the blind or the interior trim, do not lower the sun blind “quickly”.


Windscreen wiper and window wiper systems

Control lamp

	It lights up
Windscreen wiper fluid level too low	Top up the windscreen wiper reservoir as soon as possible »» page 283.

Several warning and control lamps light up for a few seconds when the ignition is switched on, signalling that the function is being verified. They will switch off after a few seconds.

Window wiper lever

Read the additional information carefully »»  page 27

⚠ WARNING

Water from the windscreen washer water bottle may freeze on the windscreen if it does not contain enough anti-freeze, reducing forward visibility.

- In winter, ensure the windscreen washer contains enough anti-freeze.
- In cold conditions, you should not use the wash/wipe system unless you have warmed »»


the windscreen with the ventilation system. The antifreeze could freeze on the windscreen and reduce visibility.

WARNING

Worn or dirty wiper blades reduce visibility and increase the risk of accident and serious injury.

- Always replace damaged or worn blades or blades which do not clean the windscreen correctly.

CAUTION

In icy conditions, always check that the wiper blades are not frozen to the glass before using the wipers for the first time. In cold weather, it may help to leave the vehicle parked with the wipers in service position
 page 55.

CAUTION

If the ignition is switched off while the windscreen wipers are on, the windscreen wipers carry on wiping at the same level when the ignition is switched back on. Ice, snow and other obstacles may damage the windscreen wiper and the respective motor.

Note

- The windscreen wipers will only function when the ignition is switched on and the respective bonnet or rear lid are closed.

- The interval wipe speed varies according to the vehicle speed. The faster the vehicle is moving, the more often the windscreen is cleaned.

- The rear wiper is automatically switched on when the windscreen wiper is on and the car is in reverse gear.

Windscreen wiper functions

Windscreen wiper performance in different situations

If the vehicle is at a standstill	The activated position provisionally changes to the previous position.
During automatic wipe	The air conditioner comes on for approximately 30 seconds in air recirculation mode to prevent the smell of the windscreen washer fluid entering the inside the vehicle.
For the interval wipe	Intervals between wipes depend on the vehicle's speed. The higher the vehicle speed the shorter the intervals.

Heated windscreen washer jets

The heating only thaws the frozen jets, it does not thaw the water in the washer hoses. The heated windscreen washer jets automatically adjust the heat depending on the ambient temperature when the ignition is switched on.

Headlight wash/wipe system

The headlight washers/wipers clean the headlight lenses.

After the ignition is switched on, the first and every fifth time the windscreen washer is switched on, the headlights are also washed. Therefore, the windscreen wiper lever should be pulled towards the steering wheel when the dipped beam or main beam are on. Any incrustated dirt (such as insects) should be cleaned regularly (e.g. when refuelling).

To ensure the headlight washers work correctly in winter, any snow which has got into the bumper jet supports should be cleaned away. If necessary, remove snow with an anti-icing spray.

Note

The wiper will try to wipe away any obstacles that are on the windscreen. The wiper will stop moving if the obstacle blocks its path. Remove the obstacle and switch the wiper back on again.

Rain sensor*

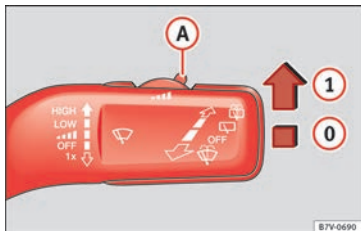


Fig. 143 Windscreen wiper lever: adjusting the rain sensor (A)

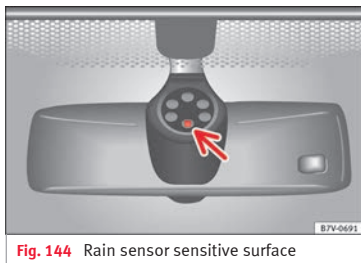


Fig. 144 Rain sensor sensitive surface

The rain sensor controls the frequency of the windscreen wiper intervals, depending on the amount of rain »» ⚠. The sensitivity of the rain sensor can be adjusted manually. Manual wipe »» page 137.

Move the lever to the required position

»» Fig. 143:

- ⓪ Rain sensor off.
- ① Rain sensor on; automatic wipe if necessary.
- (A) Setting sensitivity level of rain sensor
 - Set control to the right: highly sensitive.
 - Set control to the left: less sensitive.

When the ignition is switched off and then back on, the rain sensor stays on and starts operating again when the windscreen wipers are in position ① and the vehicle is travelling at more than 4 km/h (2 mph).

Rain sensor modified behaviour

Possible causes of faults and mistaken readings on the sensitive surface »» Fig. 144 of the rain sensor include:

- Damaged blades: a film of water on the damaged blades may lengthen the activation time, reduce the washing intervals or result in a fast and continuous wipe.
- Insects: insects on the sensor may trigger the windscreen wiper.
- Salt on roads: in winter, salt spread in the roads may cause an extra long wipe when the windscreen is almost dry.
- Dirt: dry dust, wax, coating on glass (Lotus effect) or traces of detergent (car wash) may

reduce the effectiveness of the rain sensor or make it react more slowly, later or not at all.

- Cracked windscreen: the impact of a stone will trigger a single wipe cycle with the rain sensor on. Next the rain sensor detects the reduction in the sensitive surface area and adapts accordingly. The behaviour of the sensor will vary with the size of the damage caused by the stone.

⚠ **WARNING**

The rain sensor may not detect enough rain to switch on the wipers.

- If necessary, switch on the wipers manually when water on the windscreen obstructs visibility.

i **Note**

- Clean the sensitive surface of the rain sensor regularly and check the blades for damage »» Fig. 144 (arrow).
- To remove wax and coatings, we recommend a window cleaner containing alcohol.

Rear vision mirror

Introduction

⚠ WARNING

The automatic anti-dazzle rear vision mirror contains an electrolytic fluid which may leak if the mirror is broken. This could cause irritation to the skin, eyes and respiratory organs.

- The electrolytic fluid may cause irritation to the skin, eyes and respiratory organs, particularly in individuals suffering from asthma or other illnesses. Make sure that adequate quantities of fresh air enter and leave the vehicle if it is not possible to open all the doors and windows.

- If the electrolytic fluid comes into contact with eyes or skin, wash the area for at least 15 minutes with plenty of water, and seek medical advice.

- If the electrolytic fluid comes into contact with shoes or clothing, wash the area for at least 15 minutes with plenty of water. Wash shoes and clothing before wearing them again.

- If the electrolytic fluid is swallowed, wash your mouth with plenty of water for at least 15 minutes. Do not try to provoke vomiting unless recommended by a Doctor. Seek medical advice immediately.

⚠ CAUTION

In the event that an automatic anti-dazzle rear vision mirror breaks, an electrolyte fluid may leak. This liquid attacks plastic surfaces. Therefore, it should be cleaned as fast as possible with a damp sponge or similar.

Interior rear vision mirror

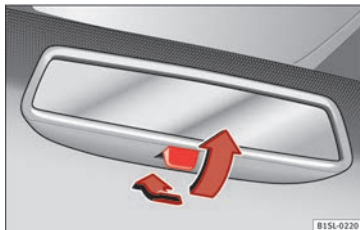


Fig. 145 Manual anti-dazzle function for rear vision mirror

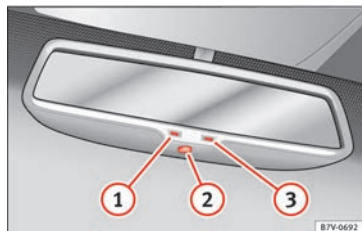


Fig. 146 Automatic anti-dazzle function for rear vision mirror

The driver should always adjust the rear vision mirror to permit adequate visibility through the rear window.

Manual anti-dazzle function for interior rear vision mirror

- Basic position: point the lever at the bottom of the mirror forwards.
- Pull the lever to the back to select the anti-dazzle function » **Fig. 145**.

Automatic anti-dazzle function for interior mirror

Key to **Fig. 146**:

- ① Control lamp
- ② Control
- ③ Light incidence sensor

This function can be activated and deactivated by pressing the rear-view mirror switch » Fig. 146 ②. When it is activated, the warning lamp lights up ①.

When the ignition is on, the sensor ③ automatically moves the rear vision mirror to the anti-dazzle position depending upon the incidence of the light from behind.

The automatic anti-dazzle function is deactivated when reverse gear is engaged or the interior or reading lights are on.

Note

If the light is obstructed or prevented from reaching the sensor, e.g. by the sun blinds, the rear vision mirror with automatic anti-dazzle function will not operate correctly.

Exterior mirrors

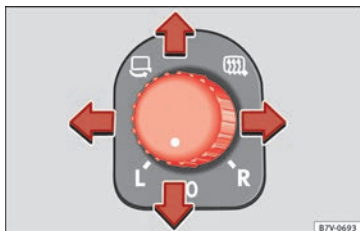


Fig. 147 In the driver door: exterior mirror controls

Read the additional information carefully » page 18

Turn the knob to the required position:



Electric folding exterior mirrors » ⚠



Switch on the exterior mirror heating They only heat up if the ambient temperature is less than +20°C (+68°F).

L

Adjust the left-hand exterior mirror by turning the knob forward, backward, to the right or to the left.

R

Adjust the right-hand exterior mirror by turning the knob forward, backward, to the right or to the left.

0

Zero position. Exterior mirror unfolded, exterior mirror heating off, adjustment of exterior mirror not possible.

Synchronised mirror adjustment

- In the **Settings - Convenience** menu, select whether or not the mirrors should move in synchronisation » page 27.
- Turn the knob to position **L**.
- Adjust the left-hand exterior mirror. The right exterior mirror will be adjusted at the same time (synchronised).
- If necessary the right exterior mirror adjustment may need correcting. turn the control to position **R**.

Automatic anti-dazzle exterior mirror, driver side

The automatic anti-dazzle exterior mirror is controlled in the same way as the automatic anti-dazzle rear vision mirror » page 140.

Store the reverse settings for the passenger exterior mirror

- Select the vehicle key in which the setting is to be stored.
- Use this key to unlock the vehicle.
- Connect the automatic parking brake.
- Turn the exterior mirror knob to position **R** (passenger side).
- Switch the ignition on.
- Move the gear lever to neutral.
- Access the **Settings** menu on the instrument panel display using the multifunction »

steering wheel buttons and select **Convenience**.

- Select the **Rear vision mirror adjustment** function (if it is already checked, uncheck it and check the option again).
- Select reverse gear.
- Adjust the front passenger side exterior mirror so that you can see, for example, the kerb area.
- The new position of the mirror will be stored automatically and allocated to the vehicle key that was used to unlock the vehicle. For vehicles with seat memory, please see » page 147.

Activating the passenger exterior mirror settings

- Turn the exterior mirror knob to position **R**.
- With the ignition switched on, select reverse gear.
- The stored position of the passenger exterior mirror for reverse gear is deleted when driving forwards at 15 km/h (9 mph), or if the knob is turned from position **R** to another position.

WARNING

Fold and unfold the exterior mirror, taking care to avoid injuries.

- Only fold or unfold the exterior mirror when there is no-one in the way of the mirror.

- When moving the mirror, take care not to trap fingers between the mirror and the mirror bracket.

WARNING

Failure to correctly estimate the distance of the vehicle behind could lead to serious accident.

- Rear-view convex or aspheric mirrors increase the field of vision, however objects appear smaller and further away in the mirrors.
- The use of these mirrors to estimate the distance to the next vehicle when changing lane is imprecise and could result in serious accident.
- If possible, use the rear vision mirror to estimate distances to vehicles behind you or in other circumstances.
- Make sure that the rear visibility is adequate.

CAUTION

- Before entering a car wash, always ensure that the exterior mirrors are correctly folded in.
- Electrically-folding exterior mirrors should not be folded and unfolded mechanically as this may damage the electrical operation.

For the sake of the environment

The exterior mirror heating should be switched off when it is no longer needed. Otherwise, it is an unnecessary fuel waste.


Note

- The exterior mirror heating initially heats up with a high power, after two minutes the heat will depend upon the ambient temperature.
- In the event of a fault, the electric exterior mirrors can be adjusted manually by pressing the edge of the mirror surface.

Seats and head restraints

Adjusting the seats and headrests

Manual adjustment of the seats

Read the additional information carefully
»  page 15


WARNING

The safe driving chapter contains important information, tips, suggestions and warnings that you should read and observe for your own safety and the safety of your passengers
» page 57.

WARNING

- Adjust the front seats only when the vehicle is stationary. Failure to follow this instruction could result in an accident.
- Be careful when adjusting the seat height. Careless or uncontrolled adjustment can cause injuries.
- The front seat backrests must not be reclined for driving. Otherwise, seat belts and the airbag system might not protect as they should in the case of an accident, increasing risk of injury.

Electric driver's seat adjustment*

Read the additional information carefully
»  page 16

WARNING

Using the front electric seats in a careless or uncontrolled manner may lead to severe injuries.

- The front seats can also be electrically adjusted when the ignition is switched off. Never leave children or disabled people alone in the vehicle.
- In the event of an emergency, stop electrical adjustment by pressing any button.

CAUTION

So as not to damage the electrical components of the front seats, do not kneel on the seats or apply specific pressure to one point of the seat or seat backrest.

Note

- It may not be possible to electrically adjust the seat if the vehicle battery is very low.
- Seat adjustment is stopped when the engine is started.

Adjusting the rear seats

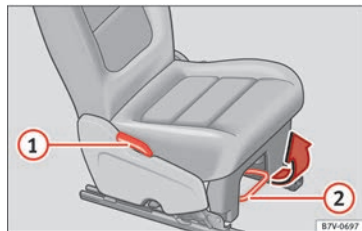





Fig. 148 Adjusting rear seats

Function	Necessary operations
 Adjusting the seat backrest.	Pull the lever and adjust the seat backrest to the required position »  . The seat backrest must be engaged when the lever is released! There is a handle instead of the lever on the third row of seats and on the central seat of the second row. It is used in the same manner as the lever.
 On the second row of seats only: moving the seat backwards or forwards.	Pull the lever and move the seat forwards or backwards. The seat must be engaged when the lever is released!

CAUTION

- Tilting the seat backrest of the second row of seats fully back could damage the luggage »

compartment tray. Remove the tray before adjusting the seat backrest.

- Objects in the luggage compartment could cause damage when moving the rear seats forwards or backwards.

Adjustment of the head restraints

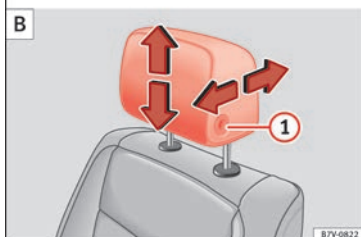
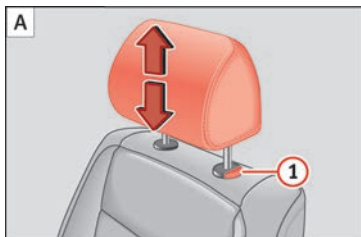


Fig. 149 A: Adjust the head restraints with no possibility of lengthways direction adjustment; B: Adjust the head restraints with lengthways direction adjustment

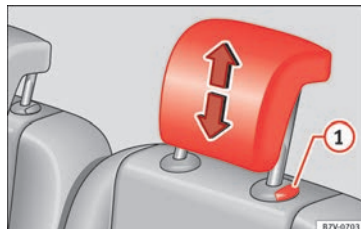


Fig. 150 Adjust the head restraints in the second or third row of seats

Read the additional information carefully

» page 17

All seats are equipped with a head restraint.

Adjusting height

- Raise the head restraint in the direction of the arrow or lower it » **Fig. 149** or » **Fig. 150** **1** with the button pressed » in **Removing and installing the head restraints** on page 146.
- The head restraint must engage securely in position. There are three possible positions on the second row of seats and two possible positions on the third row of seats.

Adjusting the front head restraints

- Push the head restraint forward in the direction of the arrow or backward » **Fig. 149** **1 B** with the button pressed.

- The head restraint must engage securely in position.

Correct adjustment of head restraints

Adjust the head restraint so that its upper edge is at the same level as the top of your head, or as close as possible to the same level as the top of your head and under no circumstances below eye level. Keep the back of your neck as close as possible to the head restraint.

Adjusting the head restraint for short people

Lower the head restraint completely, even if your head is below its upper edge. When the head restraint is at its lowest, it is possible that a small gap remains between it and the seat backrest.

Adjusting the head restraint for tall people

Raise the head restraint completely.

Removing and installing the head restraints

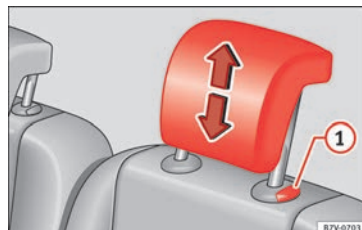
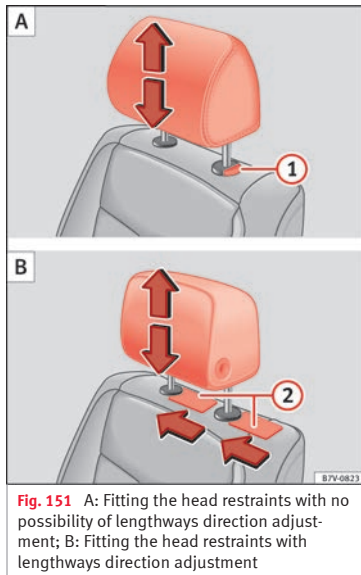


Fig. 152 Fitting the head restraints in the second or third row of seats

All seats are equipped with a head restraint.

Removing the front head restraints in vehicles without the lengthways direction adjustment of the head restraints



- If necessary, adjust the seat backrest so that the head restraint can be fitted.
- Push the head restraint up as far as it will go »» ⚠.
- Pull out the head restraint pressing the button completely »» **Fig. 151** ① A.

Fitting the front head restraints in vehicles without the lengthways direction adjustment of the head restraints

- Correctly place the head restraint into the guides on the seat backrest and insert it.
- Completely press the button ① A and push the head restraint downwards. »»

- Adjust the head restraint according to the correct seat position and secure it
» page 145.



Removing the front head restraints in vehicles with the lengthways direction adjustment of the head restraints

- If necessary, adjust the seat backrest so that the head restraint can be fitted.
- Push the head restraint up and backward as far as it will go » .
- Place a flat object, e.g. a plastic card  B, on both sides between the seat backrest cover and the end protector of the seat backrest retaining bar and unlock the retaining bars with a little pressure.
- Completely pull out the head restraint.


Fitting the front head restraints in vehicles with the lengthways direction adjustment of the head restraints

- Pull out the two retaining bars from the head restraint as far as possible.
- Correctly place the head restraint into the guides on the seat backrest and insert it.
- Push the head restraint down as far as possible until the two retaining bars are secured.
- Adjust the head restraint according to the correct seat position and secure it
» page 145.

Removing the head restraints from the second and third row of seats

- Fold the backrest of the rear seat forwards
» page 154.
- Push the head restraint up as far as it will go » .
- Pull out the head restraint » Fig. 152 
- with the button pressed.
- Fold the backrest of the rear seat backwards until it is engaged.

Fitting the head restraints in the second and third row of seats

- Fold the backrest of the rear seat forwards
» page 154.
- Insert the head restraint into the guides on the seat backrest.
- Push the head restraint down while pressing the button .
- Fold the backrest of the rear seat backward again until it is engaged.
- Adjust the head restraint to the correct position » page 144.

WARNING

Travelling with the head restraints removed or improperly adjusted increases the risk of severe or fatal injuries in the event of accidents and sudden braking or manoeuvres.

- Always fit and adjust the head restraint properly whenever a person is occupying a seat.
- Refit any removed head restraints immediately so that passengers are properly protected.
- All vehicle occupants must correctly adjust the head restraint according to their height to reduce the risk of back injuries in the event of an accident. The upper edge of the head restraint must be as close as possible to the same level as the top of your head and under no circumstances below eye level. Keep the back of your neck as close as possible to the head restraint.
- Never adjust the head restraint while the vehicle is in motion.

CAUTION

When removing and fitting the head restraint, make sure it does not hit the headliner of the vehicle or the front seat backrest. Otherwise, the interior roof and other parts of the vehicle could be damaged.

Seat functions

Seat heating*



Fig. 153 Detailed view of the centre console: front seat heating controls, here with the secondary temperature level set

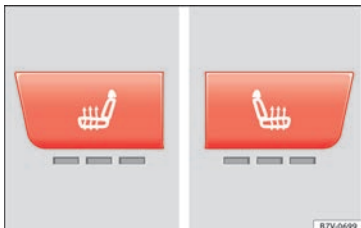


Fig. 154 Detailed view of the centre console: controls for the front seat heating in vehicles equipped with Climatronic

The seat cushions can be heated electrically when the ignition is switched on. The backrest is also heated in some versions.

Switch off seat heating if there is nobody in the seat.

Function	Action » Fig. 153, » Fig. 154
Activate	Press button . Seat heating is switched on fully.
Adjusting the heating output	Keep pressing button until the required intensity is set.
Deactivating	Keep pressing button until all of the lights are switched off » Fig. 153, » Fig. 154.

WARNING

Inappropriate use of the seat functions can cause severe injuries.

- Assume the proper sitting position before your trip and remain in it throughout. This also applies to the other occupants.
- Only adjust the seat position memory when the vehicle is stationary.
- Only switch the lumbar massage function on and off when the vehicle is stationary.
- Keep hands, fingers, feet and other limbs away from the seat operating and adjustment radius.

WARNING

People whose pain and temperature threshold has been affected by some kind of medicine, paraplegia or chronic illness (e.g. diabetes) may sustain burns to the back, buttocks and legs from using the seat heaters that may lead to a long healing process or that may never completely heal. Seek medical advice if you have doubts regarding your health.

- People with limited pain and temperature thresholds must never use seat heating.

CAUTION

- To avoid damaging the heating elements of the seat heaters, please do not kneel on the seat or apply sharp pressure to a single point on the seat cushion or backrest.
- Liquids, sharp objects and insulating materials on the seat could damage the seat heating.
- In the event of smells, switch off the seat heating immediately and have the unit inspected by a specialised workshop.

For the sake of the environment

The seat heating should remain on only when needed. Otherwise, it is an unnecessary fuel waste.


Lumbar massage function*




Fig. 155 On the side of the front seat: lumbar massage function switch.

During the massage operation, the lumbar support will move in a way that massages the lumbar area of the back. While it is operating, the arch of the lumbar support can be adjusted using the corresponding control based on your personal preferences
»» page 58.

Connection

- Press the  button in the control panel of the seat.

Disconnection

- Press the  button again in the control panel of the seat.

Automatic off

- The lumbar massage will disconnect automatically after approx. 10 minutes.

Seat with position memory*

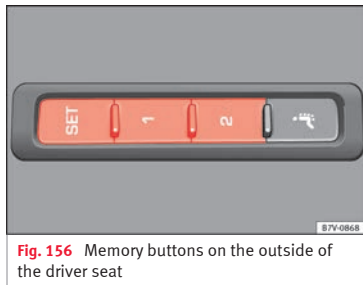


Fig. 156 Memory buttons on the outside of the driver seat

Memory buttons

Individual settings for the driver seat and the exterior mirror can be assigned to each memory button.

Storing exterior mirror settings for driving forwards

- Connect the automatic parking brake.
- Move the gear lever to neutral.
- Switch the ignition on.
- Adjust the front seat and the exterior mirrors.

- Keep the **SET** button held down for more than one second »» **Fig. 156**.
- Press the required memory button for the following 10 seconds. An audible warning confirms the settings have been stored.

Storing front passenger exterior mirror settings for driving in reverse gear


- Connect the automatic parking brake.
- Move the gear lever to neutral.
- Switch the ignition on.
- Press the required memory button.
- Select reverse gear.
- Adjust the front passenger side exterior mirror so that you can see, for example, the kerb area.
- The new position of the mirror will be stored automatically and allocated to the vehicle key that was used to unlock the vehicle.

Activating exterior mirror settings

- With the driver door open and the ignition turned off, push the memory button of the corresponding door briefly.
- **OR:** with the ignition switched on, hold in the corresponding memory button until the memorised position is reached.

To activate the memory function of the vehicle key

Important: a position must be memorised in the memory.


- Open the driver-side door.
- Press and hold any memory button.
- Within the following three seconds, push the open button  on the vehicle key. An audible warning confirms the settings have been activated.

Adjusting the wing mirrors for driving and assigning driver seat settings to a vehicle key

- Activate the memory function of the vehicle key
- Adjust the front seat and the exterior mirrors.
- Lock the vehicle. The settings are assigned to the vehicle key.

To deactivate the memory function of the vehicle key

Important: a position must be memorised in the memory.

- Press and hold the **SET** button.
- Within the following 10 seconds, push the open button  on the vehicle key. An audible warning confirms the settings have been deactivated.

Initialising the seat position memory

The position memory system must be restarted if, for example, the driver seat has been changed.

Restarting deletes all memories and assignments for the seat with position memory. The memory buttons can then be reprogrammed and the vehicle keys re-assigned.

- Open the driver door and do not get into the vehicle.
- Operating the seat settings from outside the vehicle.
- Move the angle of the seat backrest completely forwards.
- Release the control to set the angle and then press again until an audible warning is heard.

Note

The front passenger side exterior mirror automatically changes from the position stored for reversing as soon as the vehicle moves forward at a speed of at least 15 km/h (9 mph) or when the gear selection lever is changed to a position other than R.

Convenient entry function for the third row of seats

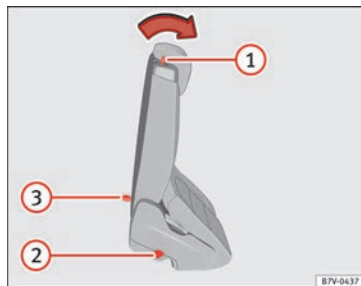



Fig. 157 Second row of seats: convenient entry function controls

The outer seats of the second row can be folded to make it easier to get in and out of the third row of seats.

Folding down the second row seats

- If necessary, open the belt loop and wind up the seat belt by hand.
- If necessary, remove the side head restraint of the integrated child seat **»» page 79**.
- If necessary, raise the armrests.
- Remove any objects located in the footwell of the second row of seats, where applicable **»»**  **!**

- Push the head restraint down as far as it will go »» page 58.
- Push the lever »» Fig. 157 ① forwards and fold the backrest of the rear seat. This seat folds forward completely »» ⚠ and can still be moved further forward.
- Always take care when entering and leaving the vehicle »» ⚠.

Repositioning the seat in the second row

- Lift the backrest of the rear seat in an upright position. The entire seat folds backwards »» ⚠.
- Make sure that the rear seat is securely engaged so that the seat belts can provide proper protection in the rear seats. The red mark »» Fig. 157 ② should no longer be visible »» ⚠ in **Folding down rear seats to create load space** on page 156.

Emergency exit function

- If the lever »» Fig. 157 ① does not work, e.g. after an accident, the seats on the second row can be folded forwards from the third row to allow vehicle occupants of the third row of seats to get out of the vehicle »» ⚠.
- Pull the handle »» Fig. 157 ③ back and fold the backrest of the rear seat. The complete rear seat folds forward »» ⚠.

⚠ WARNING

Careless or uncontrolled use of the convenient entry assistant may result in severe injury and accident.

- Never use the convenient entry function when the vehicle is in motion.
- Avoid trapping or damaging the seat belt when folding the rear seats back.
- Keep your hands, fingers, feet and other body parts out of the hinges and the seat locking mechanism when folding and unfolding.
- Mats or other objects can be caught in the hinges of the seat backrests or rear seat. This could prevent the seat backrest from locking safely when positioned upright.
- All seat backrests must engage correctly for the seat belts on the rear seats to work properly. When the seat backrest of an occupied seat is not correctly locked in place, the passenger can be thrust forward with the seat backrest in case of sudden braking, sudden manoeuvres or an accident.
- A red mark on the side of the seat »» Fig. 157 ② indicates that the seat backrest is not engaged. The mark is no longer visible when it is correctly engaged.
- If the seat backrest or seat are folded down and are not correctly locked in place, no passenger should use them.
- When getting in or out, never lean or hold onto the folded seat on the second row of seats.

⚠ WARNING

If child seats are fitted to all the seats in the second row then it is possible that the seats of this row cannot be folded down from the third row of seats in the event of an accident. In the event of an emergency, passengers in the third row of seats will not be able to leave the vehicle or to help themselves.

- Child seats should not occupy all the seats of the second row if other passengers are to occupy the third row.

ⓘ CAUTION

- Before folding down the rear seat backrest for returning it to its position, adjust the front seats so that the head restraints and seat backrests do not hit each other when folding and unfolding.
- Any objects located in the footwell of the second row of seats may be damaged on folding the rear seat forwards. Remove any objects before folding the seat down.

Folding the backrest of the front passenger seat*

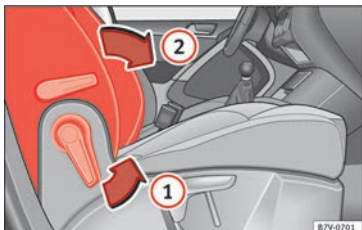


Fig. 158 Folding the backrest of the front passenger seat



Fig. 159 Unlocking the folding backrest of the front passenger seat

The backrest of the front passenger seat can be folded and locked horizontally.

The front passenger front airbag must be disabled » page 20 if objects are being transported on the folded front passenger seat.

Folding the backrest of the front passenger seat

- Remove any objects from the front passenger seat cushion » .
- Adjust the front passenger seat to its lowest position » page 58.
- Push the head restraint down as far as it will go » page 58.
- Unlock the backrest of the front passenger seat in the direction of the arrow » **Fig. 158** 1.
- Fold the backrest of the front passenger seat forwards in the direction of the arrow » **Fig. 158** 2 until it is horizontal.
- The backrest of the front passenger seat must engage safely in its folded position.

Lifting the backrest of the front passenger seat

- Check that there are no objects or parts of the body in the hinge area.
- Lift the backrest of the front passenger seat by first unlocking it again » **Fig. 159**.
- Lift the backrest of the front passenger seat until it is upright. The seat backrest must be engaged.

- The upright backrest of the front passenger seat must safely engage.

WARNING

Folding and lifting the backrest of the front passenger seat uncontrollably or without paying attention may lead to severe injuries.

- Only fold and lift the backrest of the front passenger seat when the vehicle is stationary.
- While the backrest of the front passenger seat is folded, the front airbag must remain disconnected and control light **PASSENGER AIR BAG OFF** on.
- Keep your hands, fingers, feet and other body parts out of the hinges and the seat locking mechanism when folding and unfolding.
- Mats or other objects can be caught in the hinges of the backrest of the front passenger seat. This could prevent the seat backrest from locking safely when positioned upright.
- The upright backrest of the front passenger seat must engage. If the backrest of the front passenger seat is not locked, it may suddenly move and cause severe injuries.

WARNING

Seat anchors and hinges exposed when the backrest of the front passenger seat is folded may lead to severe injuries in the event of an accident or sudden braking. »

- Never carry people or children on the front passenger seat when the seat backrest is folded.
- When the backrest of the front passenger seat is folded, only the outer seat behind the driver on the second row of seats may be occupied. This also applies to children sitting in a child seat.

Centre armrest

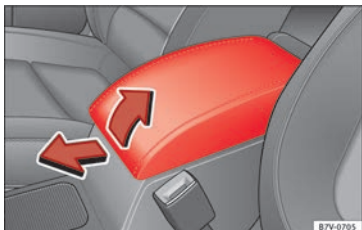


Fig. 160 Front centre armrest

To *lift* the central armrest, lift it upwards in the direction of the arrow » Fig. 160, setting by setting.

To *lower* the centre armrest, pull it downwards. Then lower the centre armrest.

⚠ WARNING

The centre armrest may limit the freedom of movement of the driver's arm and cause a serious accident.

- Keep the centre armrest compartments closed while the vehicle is in motion.
- The centre armrest is not designed for children to sit on! Sitting in this incorrect position can cause severe injuries.

Transport and practical equipment

Transporting objects


Introduction

Always transport heavy loads in the luggage compartment and place the seat backs in a vertical position. Always use the anchors provided with suitable rope to secure heavy objects. Never overload the vehicle. Both the carrying capacity as well as the distribution of the load in the vehicle affect driving behaviour and braking ability » ⚠.

⚠ WARNING

Unsecured or incorrectly secured objects can cause serious injury in case of a sudden manoeuvring or braking or in case of an accident. This is especially true when objects are struck by a detonating airbag and fired through the vehicle interior. To reduce the risks, please note the following:

- Secure all objects in the vehicle. Always keep equipment and heavy objects in the luggage compartment.
- Always secure objects with suitable rope or slings so that they cannot enter the areas around the front or side airbags in case of sudden braking or an accident.

- Always ensure that objects inside the vehicle cannot move into the area of the airbags while driving.
- While driving, always keep object compartments closed.
- Remove all objects from the front passenger seat when it is folded down. When the seat backrest is folded down, it presses on small and light objects and these are detected by the weight sensor on the seat; this sends false information to the airbag control unit.
- While the backrest of the front passenger seat is folded, the front airbag must remain disconnected and control light **PASSENGER AIR BAG OFF**  on.
- Objects secured in the vehicle should never be placed in such a way as to make passengers sit in an incorrect position.
- If secured objects occupy a seat, this seat should not be occupied or used by anyone.

WARNING

The driving behaviour and braking ability change when transporting heavy and large objects.

- Adjust your speed and driving style to visibility, road, traffic and weather conditions.
- Accelerate gently and carefully.
- Avoid sudden braking and manoeuvres.
- Brake early.

Transporting a load

Secure all objects in the vehicle

- Distribute the load throughout the vehicle, on the roof and in a trailer as uniformly as possible.
- Transport heavy objects as far forward as possible in the luggage compartment and lock the seat backs in the vertical position.
- Secure luggage in the luggage compartment with suitable straps on the fastening rings **»» page 154.**
- Check the headlight adjustment **»» page 130.**
- Use the suitable tyre pressure according to the load being transported. Read the tyre inflation information label **»» page 287.**
- For vehicles with a tyre pressure indicator, change the vehicle load status **»» page 234.**

CAUTION

Objects on the shelf could chafe against the wires of the heating element in the heated rear window and cause damage.

Note

Please note the information about loading a trailer **»» page 237** and the roof carrier system **»» page 164.**

Driving with the rear lid open

Driving with the rear lid open creates an additional risk. Secure all objects and secure the rear lid correctly and take all measures possible to reduce toxic gases from entering the vehicle.

WARNING

Driving with the rear lid unlocked or open could cause serious injuries.

- Always drive with the rear lid closed.
- Secure all objects in the vehicle. Loose items could fall out of the vehicle and injure other road users or damage other vehicles.
- Drive particularly carefully and think ahead.
- Avoid sudden manoeuvres and braking given that this could cause an uncontrolled movement of the open rear lid.
- When transporting objects that protrude out of the luggage compartment, indicate them suitably. Observe legal requirements.
- If objects must project out of the luggage compartment, the rear lid must never be used to “secure” or “attach” objects.
- If a baggage rack is fitted on the rear lid, it should be removed before travelling with the rear lid open.

»»

WARNING

Toxic gases may enter the vehicle interior when the rear lid is open. This could cause loss of consciousness, carbon monoxide poisoning, serious injury and accidents.

- To avoid toxic gases entering the vehicle always drive with the rear lid closed.
- In exceptional circumstances, if you must drive with the rear lid open, observe the following to reduce the entry of toxic gases inside the vehicle:
 - Close all windows and the sliding sunroof.
 - Turn off the air recirculation for the heating and air conditioner.
 - Open all of the air outlets in the dash panel.
 - Turn the heating fan and heater to the highest level.

CAUTION

An open boot hatch changes the length and height of the vehicle.

Driving with the vehicle loaded

For the best handling when driving a loaded vehicle, note the following:

- Secure all objects » page 153.
- Accelerate gently and carefully.

- Avoid sudden braking and manoeuvres.
- Brake early.
- If necessary, read the instructions for driving with a trailer » page 237.
- If necessary, read the instructions for driving with a roof carrier system » page 164.


WARNING

A sliding load could considerably affect the stability and safety of the vehicle resulting in an accident with serious consequences.

- Secure loads correctly so they do not move.
- When transporting heavy objects, use suitable ropes or straps.
- Lock the seat backs in vertical position.

Luggage compartment

Introduction

Always transport heavy loads in the luggage compartment and place the seat backs in a vertical position. Always use the fastening rings with suitable rope or straps. Never overload the vehicle. Both the carrying capacity as well as the distribution of the load in the vehicle have effects on the driving behaviour and braking ability » .

WARNING

When the vehicle is not in use or being watched, always lock the doors and the rear lid to reduce the risk of serious injury or death.

- Do not leave children unwatched, especially when the boot is open. Children could climb into the luggage compartment, close the rear lid from inside and be unable to escape themselves. This could lead to serious injury or death.
- Never allow children to play in or around the vehicle.
- Never transport people in the luggage compartment.

WARNING

Unsecured or incorrectly secured objects can cause serious injury in case of a sudden manoeuvring or breaking or in case of an accident. This is especially true when objects are struck by a detonating airbag and fired through the vehicle interior. To reduce the risks, please note the following:

- Secure all objects in the vehicle. Always place equipment and heavy objects in the boot.
- Always secure objects with suitable ropes or straps so that they cannot be pushed inside the cabin and move around the areas around the front or side airbags in the event of sudden braking or an accident.

- While driving, always keep object compartments closed.
- Do not place hard, heavy or sharp objects inside the vehicle interior, in open storage compartments, the rear shelf or on the dash panel.
- Remove hard, heavy and sharp objects from clothes and pockets inside the vehicle and store securely.

⚠ WARNING

The transport of heavy object changes vehicle handling and increases braking distance. Heavy loads that have not been stored or secured correctly could cause loss of control and result in serious injury.

- Vehicle handling changes when transporting heavy objects due to a change in the centre of gravity.
- Distribute the load as uniformly and as low down on the vehicle as possible.
- Store heavy objects in the luggage compartment as far from the rear axle as possible.

ⓘ CAUTION

- Hard objects on the rear shelf could chafe the wires of the heating element and antenna of the rear window and cause damage.
- The side window antenna could be damaged due to chafing from objects.

ⓘ Note

The ventilating slits between the heated rear window and the shelf must not be covered so that used air can escape from the vehicle.

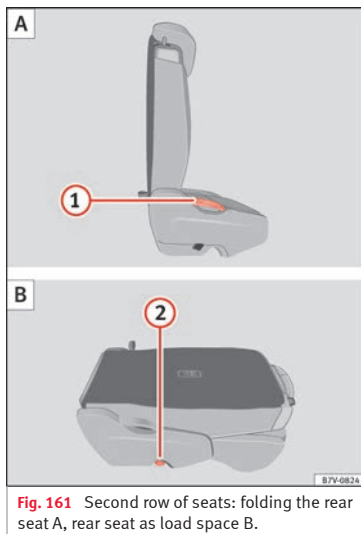
Folding down rear seats to create load space


Fig. 161 Second row of seats: folding the rear seat A, rear seat as load space B.

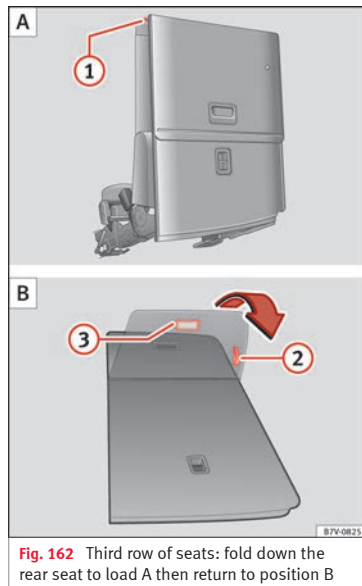


Fig. 162 Third row of seats: fold down the rear seat to load A then return to position B

Each rear seat can fold down individually to extend the luggage compartment.

Folding the seats in the second row of seats for loading

- If necessary, open the belt loop and wind up the seat belt by hand.

»

- If required, remove the head restraints from the integrated seats for children and refit them » page 79.

- If necessary, raise the armrests.

- Remove objects from the footwell in front of and behind the rear seat » ❶.

- Move the rear seat all the way back.

- Push the head restraint down as far as it will go » page 58.

- In the middle seat, close the drinks carrier in the rear of the centre console, if necessary.

- Pull lever » Fig. 161 ❶ back and fold the seat backrest forwards. The complete rear seat folds forward » ⚠.

- Fold the seat backrest forwards until it locks into the load surface position » Fig. 161 B.

- If necessary, pull on the lever » Fig. 162 ❷ to move the seat to the required position.

- When the seat is folded down, no adults or children should travel in it » ⚠.

Folding the seats in the third row of seats for loading

- If necessary, open the belt loop and wind up the seat belt by hand.

- Open the rear lid.

- Push the head restraint down as far as it will go » page 58.

- Remove objects from the footwell in front of and behind the rear seat » ❶.

- Remove objects from the space below the rear seat.

- Remove the attachment elements and supports for the net from the rail system.

- Pull lever » Fig. 162 ❶ back and fold the seat backrest forwards. The rear seat folds forward » ⚠ and the cushion also moves forward.

- Fold the seat tray forward on top of the folded seat.

- When the seat is folded down, no adults or children should travel in it » ⚠.

Putting the seats in the second row back in place

- Pull lever » Fig. 161 ❶ upwards and place the seat backrests in vertical position. The entire seat folds backwards.

- Pull on the rear seats and the seat backrest to ensure that they are correctly locked in place and that the seat belt protection is guaranteed for rear seat passengers.

Putting the seats in the third row back in place

- Open the rear lid.

- Pull on the handle » Fig. 162 ❷ to put the seat tray back in position.

- Pull the handle » Fig. 162 ❸. The entire seat folds backwards.

- Press on the seat tray in the seat backrest until it is held in position by its magnets.

- Open the sliding door.

- Put the seat backrest into position and press firmly until it clicks into place.

- Pull on the rear seats and the seat backrest to ensure that they are correctly locked in place and that the seat belt protection is guaranteed for rear seat passengers.

⚠ WARNING

Folding and lifting the rear seats carelessly without paying attention could cause serious injury.

- Never fold or lift the seats while driving.

- Do no trap or damage seat belts when raising the seat backrest.

- Keep your hands, fingers, feet and other body parts out of the hinges and the seat locking mechanism when folding and unfolding.

- Mats or other objects can be caught in the hinges of the seat backrests or rear seat. This could prevent the seat or seat backrest from locking securely in the vertical position.

- All seat backrests must engage correctly for the seat belts on the rear seats to work properly. When the seat backrest of an occupied seat is not correctly locked in place, the passenger can be thrust forward with the seat

backrest in case of sudden braking, sudden manoeuvres or an accident.

- No seat must be occupied if the seat backrest or seat is folded or not correctly engaged.

⚠ CAUTION

- Before folding the rear seat backrest, adjust the front seats so that neither the head restraint or backrest hit them when folded.
- Objects placed in the footrest area in front of and behind the rear seats can be damaged when seats are folded down or put back into position. Remove any objects in the way before folding seats down or repositioning them.
- Objects placed in the moulding on the back of the third row of seats can be damaged when folding down the seats or putting them back into position. Remove any objects in the way before folding seats down or repositioning them.
- The attachment elements and supports for the net partition placed on the rail system can be damaged when folding down seats from the third row or putting them back into position and these can also damage the seats themselves. Before folding down or repositioning the seats, remove the attachment elements and supports for the net from the rail system.

Shelf*

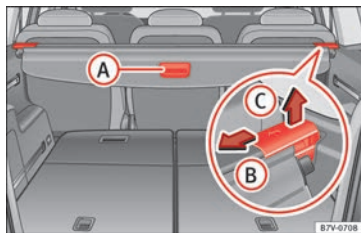


Fig. 163 In the luggage compartment: rear shelf

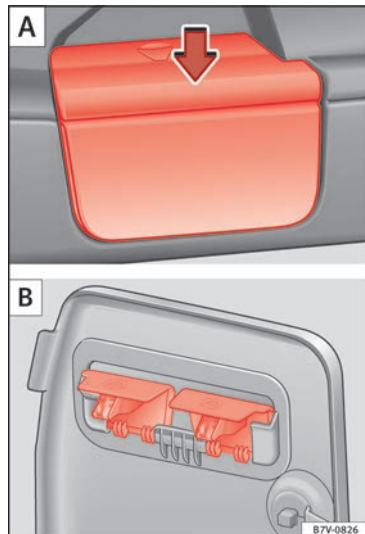


Fig. 164 Remove the shelf supports A then put them away safely B.

The rear shelf can be fitted behind the second or third row of seats » » » ⚠.

Opening the shelf

- Pull the shelf handle » » » **Fig. 163** Ⓐ a little bit backwards. » »

- Release the shelf upwards by the side supports and guide it forward.

Closing the shelf

- Pull the unfolded shelf evenly on the guide backwards.
- Secure the shelf using the left and right side supports.

Installing the shelf behind the second row of seats

- Place the shelf in its position in the side lining, left-hand side first.
- Release the shelf in the direction of the arrow »» Fig. 163 (B).
- Insert the shelf into the right-hand support, pressing down.

Installing the shelf behind the third row of seats

- Remove the shelf from the support in the side lining »» Fig. 164 A. To do this, press the shelf upwards (arrow) and remove it.
- Open the compartment in the left-hand side boot lining »» page 166 and hook the shelf to the rear of the compartment lid »» Fig. 164 B.
- Close the rear left-hand side lining compartment.
- Place the shelf in its position in the side lining, left-hand side first.

- Lift the shelf off in direction of the arrow »» Fig. 163 (B).
- Insert the shelf into the right-hand support, pressing down.

Removing the shelf

- Release the shelf in the direction of the arrow »» Fig. 163 (B) and lift it in the direction of the arrow (C).
- Remove the shelf from the right-hand side support.
- **In addition, when removing the shelf behind the third row of seats:** cover the side lining supports with their covers.
- **Only with 5 places:** support the released shelf by placing it on the front section of the boot floor »» page 166.

WARNING

If the shelf is placed on one of the rear seats, this could cause serious injury in case of sudden braking or an accident.

- Whenever it the third row seats are occupied, the shelf should be put behind this row.

WARNING

Unsecured or incorrectly secured objects or animals on the rear shelf could cause serious injuries in case of a sudden manoeuvre or braking or even an accident.

- Do not leave hard, heavy or sharp objects (loose or in bags) on the rear shelf.
- Never transport animals on the rear shelf.

Net partition*

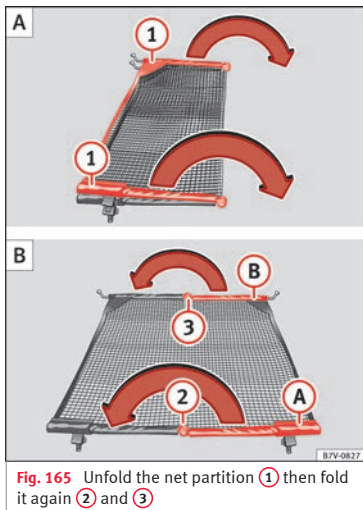


Fig. 165 Unfold the net partition ① then fold it again ② and ③

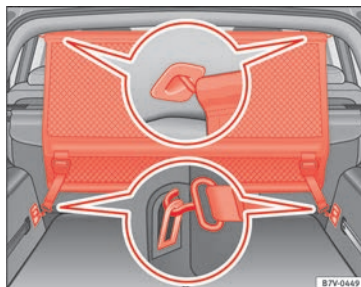


Fig. 166 In the luggage compartment: install the net partition behind the second row of seats.

The net partition can prevent objects in the luggage compartment entering the vehicle interior / the driver area.

First remove the net from its bag and unfold it.

Fold out the net partition

Fold out the cross support rods » **Fig. 165** ① for the net partition fully in the direction of the arrow until you hear a “click”.

Installing the net partition behind the second row of seats

- Hook in the net partition on the left-hand side roof support » **Fig. 166**. To do this, guide the rod from up to down.

- Hook in the net partition on the rear right-hand side roof support by pressing on the rod.
- Secure the net partition hooks into the straps in the front of the boot » **Fig. 166** then tighten the belts.

Installing the net partition behind the front seats

- Hook in the net partition on the front left-hand side roof support » **Fig. 166**. To do this, guide the rod from up to down.
- Hook in the net partition on the rear right-hand side roof support by pressing on the rod.
- Secure the hooks of the net partition to the attachment rings in the left and right hand side footwells on the second row of seats then tighten the straps.

Removing the net partition

- Loosen the net partition straps.
- Release the net partition hooks from the rings » **Fig. 166**.
- Unhook the net partition on the right-hand side roof support » **Fig. 166** by pressing on the rod.
- Unhook the net partition from the left-hand side roof support.

»

Folding in the net partition

- Press on the release button »» Fig. 165 ② and bend the rod (A) in the direction of the arrow with the release button pressed.
- Press on the release button »» Fig. 165 ③ and bend the rod (B) in the direction of the arrow with the release button pressed.
- Store the net partition securely in the vehicle.

⚠ WARNING

Loose objects in the vehicle interior can be violently thrown in case of a sudden manoeuvre or braking and especially in accidents causing serious injury.

- Ensure that the rods are correctly locked in place.
- Even when the net partition is correctly fitted, objects must be secured.
- When driving with the net partition, no passengers should be behind it.

Fastening rings*

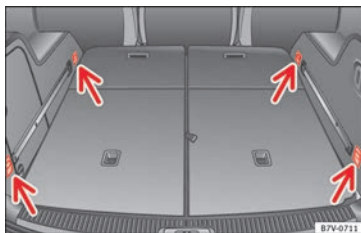


Fig. 167 In the luggage compartment: fastening rings

To the front and rear of the luggage compartment, there are fastening rings for securing objects »» Fig. 167 (arrows). On some models, the fastening rings are located right at the back, in the area of the lock carrier plate.

There are other fastening rings located to the left and right hand side of the second row footrests.

Some models of fastening rings must be lifted to use them.

⚠ WARNING

Unsuitable or damaged ropes or straps may be released in case of sudden braking or an accident. As a result, objects may be fired through the vehicle interior causing serious injury or death.

- Always use suitable ropes and straps in good condition.
- Secure the ropes and straps to the fastening rings.
- Loose objects in the luggage compartment can suddenly slide and change the way the vehicle handles.
- Secure all objects, little and large.
- Never secure a load that is too heavy for the fastening rings.
- Never secure a child seat to the fastening rings.

i Note

- The maximum load of the fastening rings is approximately 3.5 kN (3.57 kp).
- You can find suitable transport straps and load securing systems at a specialised workshop. SEAT recommends taking your car in for technical service.

Rails and attachment system*

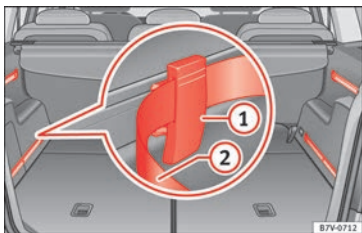


Fig. 168 In the luggage compartment: system including rails, adjustable attachment elements ① and adjustable tightening straps ②.

The rails and attachment system consists of four rails, movable attachment elements, straps to be secured to the rails and a net with supports to cover baggage » page 162. The rail and attachment system is designed to secure light objects. If the seats in the third row are to be occupied by passengers then attachment elements should never be placed in the section of the rails close to the seats » ⚠.

Installing the attachment elements

• Fit the attachment element with the ruts facing upwards » Fig. 168 ① to the upper part of the guide and press downwards.

- Move the attachment element to the desired position.
- Always ensure that the attachment inserts into the guide system » ⚠.

Removing the attachment elements

- Remove the attachment element from the guide and pull downwards.

Securing a load

- Pull the strap through the attachment element and secure the load » ⚠.

⚠ WARNING

In case of an accident or sudden braking, the attachment elements in the parts of the rails close to the seats of the third row could injure seat occupants.

- Whenever the seats on the third row are to be occupied, remove the attachment elements from the rails or move them all the way back.

⚠ WARNING

Movable attachment elements that are not secured correctly can be released from the guide in case of sudden braking or accident. As a result, objects may be fired through the vehicle interior causing serious injury or death.

- Always ensure that the movable attachment elements are correctly inserted into the guides.

⚠ WARNING

Unsuitable or damaged ropes or straps may be released in case of sudden braking or an accident. As a result, objects may be fired through the vehicle interior causing serious injury or death.

- Always use the attachment straps of the rail and attachment system.
- Secure the attachment straps firmly to the attachment elements.
- Loose objects in the luggage compartment can suddenly slide and change the way the vehicle handles.
- Secure all objects, little and large.
- Never secure a child seat to the attachment elements.

ⓘ CAUTION

• The attachment elements placed on the rail system can be damaged when folding down seats from the third row or putting them back into position and these can also damage the seats themselves. Before folding down or re-positioning the seats, remove the attachment elements and supports for the net from the rail system.

Baggage net*

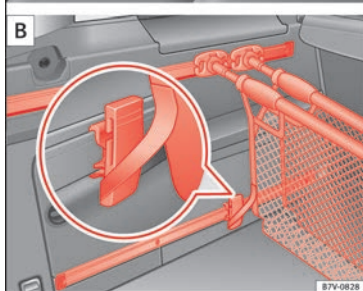
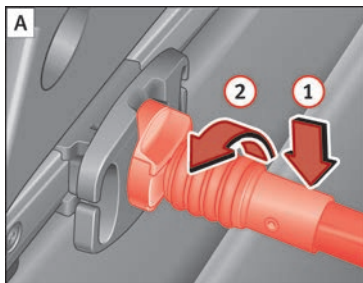


Fig. 169 Hook the baggage net A and use it as a bag B.

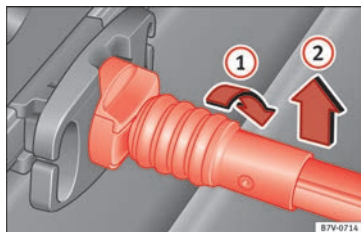


Fig. 170 Release the baggage net

If the seats in the third row are to be occupied by passengers then attachment elements should never be placed in the section of the rails close to the seats » » » ⚠.

Installing the baggage net supports

- Fit the baggage net support into the guide from the back and press downwards.
- Move the baggage net support to the required position.
- Always ensure that the net support inserts into the rail system » » » ⚠.

Hooking the baggage net into the support

Place the attachment rod on the baggage net support » » » Fig. 169 ① and rotate 90° to the left ②. The red mark on the attachment rod should not be visible » » » ⚠.

Using the net for bag type baggage

- Fit the baggage net supports to each one of the upper rails.
- Fit a movable baggage net attachment element to each one of the lower guides » » » page 161.
- Hook the baggage net into the supports.
- Hook the baggage net attachment strap underneath into one of the movable attachment elements » » » Fig. 169 B.
- Join the baggage net supports to the upper rails as much as possible by pushing them.
- Press the sides of the baggage net together so that they are held by the Velcro.

Using the baggage net to separate the luggage compartment

- Fit the baggage net supports to each one of the upper rails.
- Fit the baggage net supports to each one of the lower rails.
- Hook the baggage net into the supports.

To release the baggage net

- Rotate the attachment rod 90° to the right » » » Fig. 170 ① until you can see the red mark on the rod. Pull the attachment rod upwards ②.
- **Only with 5 places:** after removing, place the baggage net safely in the front compartment on the floor of the boot » » » page 166.

Removing the baggage net supports

- Remove the net attachment element from the rail and pull it out downwards.

⚠ WARNING

In case of an accident or sudden braking, the net attachment elements in the parts of the rails close to the seats of the third row could injure seat occupants.

- Whenever the seats on the third row are to be occupied, remove the attachment elements from the rails or move them all the way back.

⚠ WARNING

Baggage net supports that are not secured correctly can be released from the guide in case of the sudden braking or accident. As a result, objects may be fired through the vehicle interior causing serious injury or death.

- Always ensure that the baggage net supports are correctly inserted into the rails; the red mark should not be visible.
- Never secure a child seat to the baggage net supports.

⚠ CAUTION

- The baggage net supports placed on the rail system can be damaged when folding down seats from the third row or putting them back into position and these can also damage the seats themselves. Before folding

down or repositioning the seats, remove the baggage net supports from the rail system.

Retaining hooks

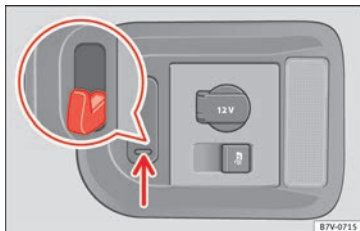


Fig. 171 In the luggage compartment: retaining hooks

On the right-hand side of the luggage compartment, there are folding retaining hooks **» Fig. 171** that can be used to secure light shopping bags.

- Press the retaining hooks down **» Fig. 171** (arrow) and fold them.
- Hook the bags in place.
- After use, raise the hooks again.

⚠ WARNING

Never use these hooks to secure objects. In the event of sudden braking or an accident, they could be pulled out.

⚠ CAUTION

The hooks can support a maximum of 2.5 kg (about 5 lbs).

Luggage net*

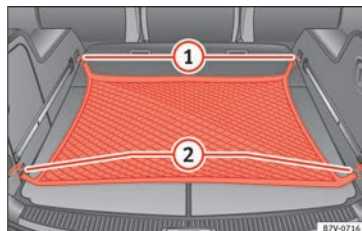


Fig. 172 In the luggage compartment: net used on secured baggage

The baggage net can be used to secure lighter items.

Hooking the baggage net into the boot floor

- Hook the baggage net into the fastening rings **» Fig. 172** ① and ②.

Releasing the baggage net

The secured baggage net is taut **»** ⚠.

- Carefully unhook the baggage net hooks from the fastening rings **» Fig. 172** ①. **»**

- Carefully unhook the baggage net hooks from the fastening rings » Fig. 172 ②.

⚠ WARNING

The elastic baggage net stretches when it is secured to the luggage compartment fastening rings. The secured baggage net is taut. The hooks on the net can cause injury if the net is incorrectly hooked or unhooked.

- Always ensure that the hooks do not suddenly release from the fastening rings when hooking or un-hooking.
- Always keep your face and eyes protected at a safe distance to avoid injury should a hook slip while hooking or unhooking.
- Always engage the hooks in the order given. If a baggage net hook springs back this can cause injury.

Roof carrier*

Introduction

The vehicle roof has been designed to optimise aerodynamics. For this reason, conventional roof carrier systems cannot be secured to the roof water drain channel.

Given that the water drains have been incorporated into the roof for aerodynamic reasons, only the SEAT approved basic supports and roof carrier systems can be used.

When should the roof carrier system be removed?

- When it is not being used.
- When the vehicle is being washed in a car wash.
- When the vehicle height exceeds the maximum height (e.g. in a garage).

⚠ WARNING

The risk of an accident is increased by transporting heavy or bulky loads on the roof, which affects the car's handling by shifting the centre of gravity and increasing susceptibility to cross winds.

- Always secure loads correctly with suitable and undamaged attachment rope or straps.
- Large, heavy, wide and flat loads negatively affect the vehicle aerodynamics, centre of gravity and handling.
- Avoid brusque manoeuvres and sudden braking.
- Adjust your speed and driving style to visibility, road, traffic and weather conditions.

⚠ CAUTION

- Always remove the roof carrier system from the roof before entering a car wash.
- The height of your vehicle is changed by the installation of the roof carrier and the load secured on it. Compare the vehicle height with the passage height, for example in underground car parks or for garage doors.

- The roof antenna, the range of the panoramic sliding sunroof and the boot hatch should not be affected by the roof carrier system and the load being transported.
- Take extra care not to let the hatch strike the roof load when opening.

🌿 For the sake of the environment

The vehicle uses more fuel when the roof carrier system is fitted.

Fastening the base supports and the roof carrier system

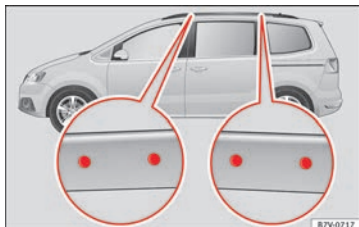


Fig. 173 Attachment points for the basic support and the roof carrier system

The mounts are the basis of a complete roof carrier system. Special fixtures must then be added in order to safely transport luggage, bicycles, skis, surf boards, boats, etc. on the

roof. All these system components are available from a technical service centre.

Securing the base supports and roof carrier system

Always secure the base supports and roof carrier system correctly.

The roof carrier system must always be installed exactly according to the instructions provided.

The position openings are located on the inner side of the side roof rods » Fig. 173.

WARNING

If the base supports and the roof carrier system are incorrectly fitted or used in an unsuitable manner, the entire system could break free causing accident and injury.


- Always take the manufacturer assembly instructions into account.
- Only use base supports and roof carrier systems that are not damaged and are correctly fitted.
- The base support should only be fitted to the points indicated in the diagram » Fig. 173.
- Secure the base supports and roof carrier system correctly.
- Check the screws and attachments before driving and after a short distance. During each long journey, check the attachments during every break.

- Always fit the roof carrier system correctly for wheels, skis, surfboards, etc.
- Never modify or repair the basic supports or roof carrier system.


Note

Read and take into account the instructions included with the roof carrier system fitted and keep them in the vehicle.

Loading the roof carrier

Loads can only be correctly secured when the roof carrier system is correctly fitted » .


Maximum authorised roof load

The maximum authorised roof load is **100 kg (220 lbs)**. The roof load includes the roof carrier system and the load being transported » .

Always check the roof carrier system weight and the weight of the load to be transported and, if necessary, weigh them. Never exceed the maximum authorised roof load.

If you are using a roof carrier with a lower weight rating, you cannot transport the maximum roof load. Do not exceed the maximum weight limit for the roof carrier given in the fitting instructions.

Distributing a load

Uniformly distribute loads and secure them correctly » .

Check attachments

After fitting the base supports and the roof carrier system, always check the attachments after a short trip and at regular intervals.

WARNING

Exceeding the maximum authorised roof load can result in accidents and/or vehicle damage.

- Never surpass the maximum authorised weight for the roof, the maximum authorised weight on the axles and the total maximum authorised weight of the vehicle.
- Never exceed the capacity of the roof carrier system even if this is less than the maximum authorised roof load.
- Secure heavy items as far forward as possible and, in general, distribute the vehicle load uniformly.

WARNING

Loose and incorrectly secured loads can fall from the roof carrier system causing accidents and injury.

- Always use suitable ropes and straps in good condition.
- Always secure loads correctly.

Storage compartments

Introduction

Storage compartments must only be used to store light or small objects.

In the front centre armrest compartment the following factory-fitted connections are available: **USB/AUX-IN**.

The factory-fitted **CD changer** is located in the left-hand storage compartment of the boot.

WARNING

In the event of sudden braking movements or turns, loose objects may be thrown around the vehicle interior. This could cause serious injuries to passengers and cause the driver to lose control of the vehicle.

- Do not transport animals or place hard, heavy or sharp objects inside the vehicle in: open storage compartments, dash panel, rear shelf, items of clothing or bags.
- While driving, always keep object compartments closed.

WARNING

Objects falling into the driver's footwell could prevent use of the pedals. This could lead the driver to lose control of the vehicle, increasing the risk of a serious accident.

- Make sure the pedals can be used at all times, with no objects rolling underneath them.
- The floor mat should always be secured to the floor.
- Never place other mats or rugs on top of the original mat supplied by the factory.
- Make sure that no objects can fall into the driver's footwell while the vehicle is in motion.

CAUTION

- Objects on the shelf could chafe against the wires of the heating element in the heated rear window and cause damage.
- Do not keep heat-sensitive objects, food or medicines inside the vehicle. Heat and cold could damage them or render them useless.
- Light-transparent objects placed inside the vehicle, such as lenses, magnifying glasses or transparent suction caps on the windows, may concentrate the sun's rays and cause damage to the vehicle.

Note

The ventilating slits between the heated rear window and the shelf must not be covered so that used air can escape from the vehicle.

(Sun)glasses case in the roof console

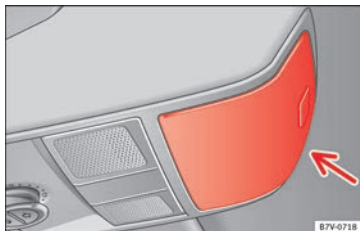


Fig. 174 On the roof console: sunglasses storage compartment.

To *open*, press and release the button » **Fig. 174** (arrow).

To *close*, press the cover upwards until it clicks into place.

To ensure the interior monitoring works correctly, the (sun)glasses case must be closed when the vehicle is locked » page 120.

Storage compartment in the roof console



Fig. 175 On the roof console: storage compartment

To *open* press the button and release it
» **Fig. 175**.

To *close*, press the storage compartment upwards until it clicks into place.

To ensure interior monitoring works properly, the storage compartments must be closed when the vehicle is locked » **page 120**.

Compartment on the instrument panel*

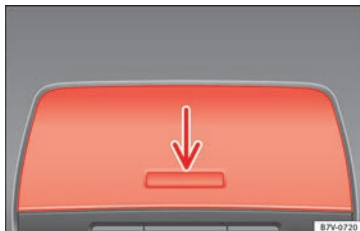


Fig. 176 Storage compartment on the dash panel

The storage compartment on the instrument panel may have a cover.

To *open*, press the button on the cover
» **Fig. 176** (arrow).

To *close*, press the cover down until it clicks into place.

Compartment on the centre console

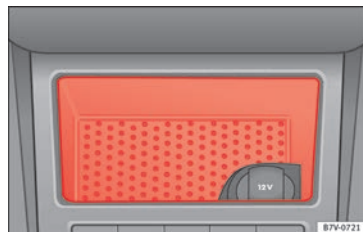


Fig. 177 Compartment in the front centre console.

There is an open compartment on the centre console » **Fig. 177** in which there may be a 12 volt power socket » **page 173**.

Compartment in the front central armrest



Fig. 178 Storage compartment in the front central armrest.

To *open*, fully lift the central armrest in the direction of the arrow » **Fig. 178**.

To *close*, lower the central armrest.

⚠ WARNING

The centre armrest may limit the freedom of movement of the driver's arm and cause a serious accident.

- Keep the centre armrest compartments closed while the vehicle is in motion.

⚠ WARNING

The centre armrest is not designed for children to sit on!

Card compartment*

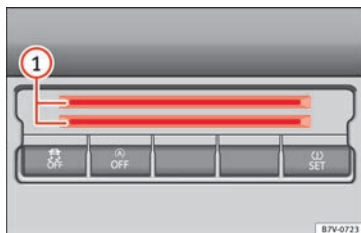


Fig. 179 Centre console, lower section: card compartment

To the bottom of the centre console there is a compartment » **Fig. 179** ① for coins, cards, car park tickets and similar items.

i Note

To avoid theft or use by others, do not use the compartment to store credit or ATM cards or similar.

Glove compartment



Fig. 180 Glove compartment

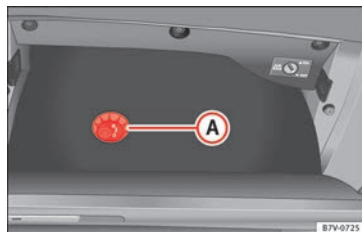


Fig. 181 Glove compartment open

Opening and closing the glove compartment

Unlock the glove compartment where necessary. The glove compartment is locked when the key slot is vertical.

Pull the handle to *open* » **Fig. 180**.

Press the cover upwards to *close*.

Vehicle wallet compartment

The glove compartment is designed to store the vehicle documentation.

The vehicle on-board documentation wallet should always be kept in the glove compartment. Insert it crosswise in the glove compartment.

Glove compartment cooling

There is an air vent » Fig. 181 (A) on the rear panel so that cooled air from the air conditioner (this must be connected) is fed into the glove compartment. Turn the air vent to open and close it.

⚠ WARNING

The risk of serious injuries in the event of an accident during a sudden braking manoeuvre or turn is increased if the glove compartment is left open.

- Keep the glove compartment closed while the vehicle is in motion.

ⓘ CAUTION

For structural reasons, some model versions will have gaps behind the glove compartment into which small objects may fall. This could lead to strange noises and damage to the vehicle. You should therefore not keep very small objects in the glove compartment.

Storage compartments in the rear footwell*

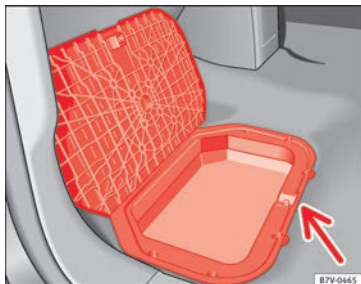


Fig. 182 Storage compartments in the footwell of the second row of seats.

Move the mat to one side (where applicable).

To *open*, pull on the rear centre part of the cover » Fig. 182 (arrow).

To *close*, press the cover down.

⚠ WARNING

Make sure children are properly belted in and correctly secured to avoid severe or fatal injuries while the vehicle is in motion.

- If you are using a child seat with a base or foot, always install this base or foot correctly and safely.
- If the vehicle has a storage compartment in the footwell in front of the last row of seats,

this compartment cannot be used as designed; on the contrary, it must be filled using the specially designed accessory so that the base or foot is correctly supported by the closed compartment and the child seat is secured properly. If this compartment is not suitably secured when using a child seat with a base or foot then the compartment cover could rupture in an accident and the child will be ejected and suffer serious injury.

- Please read and observe the child seat manufacturer's handling instructions.

Drawers*

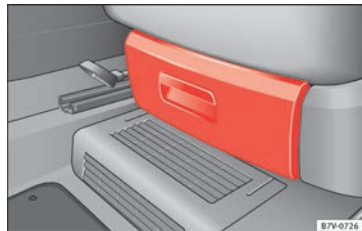


Fig. 183 Drawer under the front seat

There may be a drawer below the front seats.

Opening and closing the drawer

To *open*, press the button on the drawer handle and pull the drawer out. »

To *close*, push the drawer under the seat until it clicks into place.

WARNING

If the drawer is open it could obstruct use of the pedals. This could result in serious accident.

- The drawers must remain closed while the vehicle is in motion. Otherwise, the drawer and any objects in it could fall into the driver's footwell and obstruct the pedals.

Folding table*



Fig. 184 Folding table on the front seat

Fold out the table by pulling on it » **Fig. 184** (arrow).

A drink holder is built into the folding table » **page 171**.

To *fold it back*, push the folding table down as far as possible » **Fig. 184**.

WARNING

The folding table must not be folded down while the vehicle is in motion to avoid the risk of injuries.

Portable waste bin*

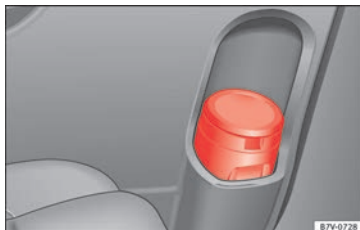


Fig. 185 Left sliding door trim: portable waste bin.

The portable waste bin fits onto the bottle holder on the trim of the left-hand sliding door.

WARNING

Do not use the portable waste bin as an ash-tray to avoid the risk of fire.

Other storage compartments

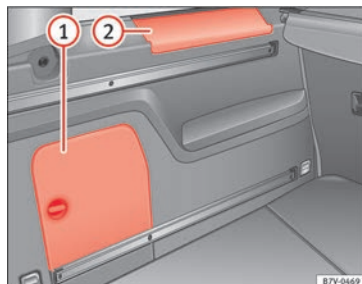


Fig. 186 In the luggage compartment: Side storage compartment

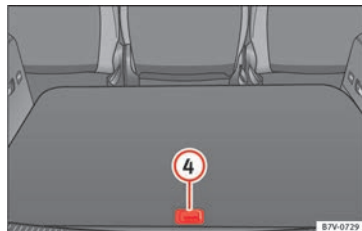


Fig. 187 Other compartments in the boot floor.

Side compartments in the luggage compartment

There are other compartments » Fig. 186 ① and ② in the side of the boot. To open the compartment ①, turn the catch clockwise. To open the compartment ②, lift the cover. Compartment ① houses the factory fitted **CD changer**. The compartment lid ① can safely store the tray support covers.

Compartments in the boot floor

More storage compartments can be found in the boot floor.

Function	Necessary operations
Open the rear compartment » Fig. 187 ④:	▷ Lift the rear of the boot floor using the handle.
Keeping the rear compartment open:	▷ Move the hook at the rear right of the boot and hook the boot floor onto it » page 154.
Closing the compartment:	▷ Push back the hook and push the rear of the boot floor ④ down.

Other storage compartments:

- in the centre console, front and rear.
- in the door trims, front and rear.
- **Coat hooks** on the central door pillars and on the rear roof handles.

- **Bag hook** in the luggage compartment » page 154.

⚠ WARNING

Clothing hung on the coat hooks could restrict the driver's view and lead to serious accidents.

- Hang the clothes from the hooks so that driver's view is not restricted.
- The coat hook is suitable for light items of clothing. Never place heavy, hard or sharp objects in the bags.

ⓘ CAUTION

Keep the CD changer compartment closed while the vehicle is in motion to reduce vibrations that could damage the changer.

ℹ Note

The first aid kit is located in the rear left compartment of the luggage compartment.

Drink holders

Introduction

Bottle holders

There is a bottle holder in the open compartments in the driver and front passenger doors and in that of the sliding door.

⚠ WARNING

Improper use of the drink holders can cause injury.

- Never place hot drinks in the drink holders. During sudden braking or driving manoeuvres, the hot drink could be spilled and lead to scalding.
- Ensure that no bottles or other object are dropped in the driver footwell, as they could get under the pedals and obstruct their working.
- Never place heavy containers, food or other heavy objects in the drink holder. In the event of an accident, these heavy objects could be "thrown around" the vehicle interior and cause serious injuries.

⚠ WARNING

Closed bottles inside the vehicle could explode or crack due to the heat or the cold.

- Never leave a closed bottle in the vehicle if the inside temperature is too high or too low.

ⓘ CAUTION

Do not leave open cans in the drink holders when the vehicle is in motion. They could spill during braking, for example, and cause damage to the vehicle and the electrical system.

Note

The drink holders can be removed for cleaning.

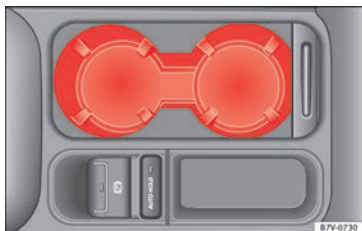
Drink holders in front centre console

Fig. 188 Front centre console: drink holder

- To *open*, move the cover backwards »» **Fig. 188**.
- To *close*, move the cover forwards.

Drink holders, rear*

Fig. 189 Centre console, rear section: folding out the drink holder

Opening and closing the drink holder in the rear centre console

- To *open*, move the drink holder downwards in the direction of the arrow »» **Fig. 189**.
- To *close*, lift the drink holder.

The third row of seats has a drink holder in the side trim compartment on the rear left.

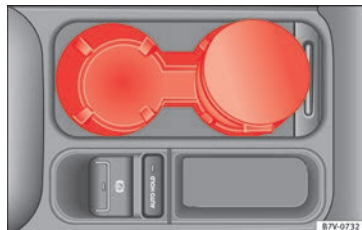
Ashtray and cigarette lighter***Ashtray**

Fig. 190 Front centre console: ashtray closed

There are ashtrays located on the front of the centre console »» **Fig. 190** and on the rear lining of the rear door.

Opening and closing the ashtray

- To *open*, lift the ashtray cover.
- To *close*, push the ashtray cover down.

Emptying the ashtray

- Remove the ashtray from the drink holder or lining of the door by pulling it upwards.
- After emptying the ashtray, insert it from above into the drink holder or door lining.

⚠ WARNING

Incorrect use of the ashtray may cause a fire or burns and other serious injuries.

- Never put paper or other flammable objects in the ashtray.

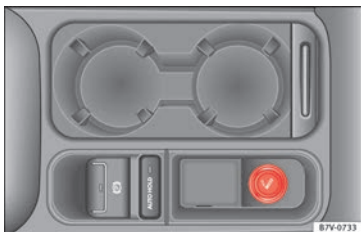
Cigarette lighter

Fig. 191 Front centre console: lighter

Depending on the vehicle equipment, there may be a lighter to the front of the centre console »» **Fig. 191** or in the compartment to the front of the centre console.

- Push the button on the cigarette lighter inwards with the ignition on »» **Fig. 191**.
- Wait for the lighter to pop out slightly.
- Pull out the cigarette lighter and light the cigarette on the glowing coil »» **⚠**.
- Replace the cigarette lighter in its insert.

⚠ WARNING

Undue use of the cigarette lighter may cause a fire or burns and other serious injuries.

- The cigarette lighter must only be used to light cigarettes or similar.
- Never leave children unsupervised in the vehicle. The cigarette lighter can be used when the ignition is switched on.

i Note

The cigarette lighter can also be used with the 12 volt power socket »» page 173.

Power sockets**Introduction**

Electrical equipment can be connected to the power sockets in the vehicle.

All connected appliances should be in perfect working order without any faults.

⚠ WARNING

Improper use of the power sockets or electrical devices could lead to a fire and cause serious injuries.

- Never leave children unsupervised in the vehicle. The power sockets and equipment connected to them can be used when the ignition is switched on.

- Should a connected electrical device overheat, switch it off and unplug it immediately.

ⓘ CAUTION

- To avoid damage to the vehicle's electrical system, never connect equipment that generates electrical current, such as solar panels or battery chargers, to the 12 volt power sockets in order to charge the vehicle's battery.
- Only use accessories with approved electromagnetic compatibility according to current regulations.
- To avoid damage due to voltage variations, switch off all devices connected to the 12 V power sockets before switching the ignition on or off and before starting the engine.
- Never connect an appliance to the 12 volt power socket that consumes more than the power indicated in watts. Exceeding the maximum power absorption could damage the vehicle's electrical system.

🌿 For the sake of the environment

Do not leave the engine running when the vehicle is at a standstill.

i Note

- Using devices with the engine stopped and the ignition switched on will drain the battery.

- Unshielded equipment can cause interference on the radio equipment and the vehicle's electrical system.
- Interference can occur on the radio's AM waveband if electrical appliances are used near the rear window aerial.

Vehicle power sockets



Fig. 192 Centre console, rear section: 12 volt socket



Fig. 193 Rear centre console: 230 Volt Euro power socket

Depending on your vehicle version, you may have a 12-volt power socket and/or a 230 volt power socket.

Maximum power consumption

Power socket	Maximum power consumption
12 Volts	120 Watts
230 Volts	150 Watts (300 Watt peak)

The maximum capacity of each power socket must not be exceeded. The power consumption is indicated on the rating plate of each appliance.

Where two or more appliances are connected at the same time, the total rating of all the connected devices must never exceed 190 Watts » ❶.

12 volt power socket

The 12 volt power socket will only work with the ignition on.

Using electrical appliances with the engine stopped and the ignition switched on will drain the battery. Therefore, electrical devices connected to the power socket can only be used when the engine is running.

To prevent voltage variations from causing damage, switch off the electrical consumer connected to the 12 volt power socket before switching the ignition on or off and before starting the engine.

12 volt power sockets can be found in the following locations in the vehicle:

- Compartment in the centre of the centre console.
- Compartment in the front centre console.
- Storage compartment in the front central armrest.
- Rear centre console » **Fig. 192.**
- At the rear right of the luggage compartment.

230 Volt Euro power socket*

The power socket only works when the engine is running » ❷.

Connecting an electrical appliance: plug the device into the power socket as far as possible to unlock the built-in childproof lock. The

current only flows when the childproof lock is unlocked.

LED on the power socket » Fig. 193

Steady green light:	The childproof lock is unlocked. The power socket can now be used.
Flashing red light:	There is some kind of fault (e.g. disconnection due to excess current or temperature).

Heat protection

The 230 Volt Euro power connector converter switches off automatically when a certain temperature is exceeded. This disconnect prevents overheating in the event of an increase in power consumption of the connected appliance and where the atmospheric temperature is too high. The inverter will switch on again automatically after it has cooled down. Appliances that are switched on and connected to the power socket will start up again. Therefore, switch off all electrical appliances connected to the power socket when the current converter switches off due to overheating.

WARNING

High voltage in the electrical installation!

- Liquids must not be spilt over the power socket.

- Do not plug adapters or extension cords into the 230 Volt Euro power connector. Otherwise, the built-in child safety device will switch off and the connector will become live.
- Do not plug current conductors such as a knitting needle into the 230 Volt Euro power connector.

CAUTION

- Always follow the operating instructions for the appliances to be connected!
- Never exceed the maximum power rating as this could damage the vehicle's general electrical system.
- 12 volt power socket:
 - Only use accessories with approved electromagnetic compatibility according to current regulations.
 - Never power the socket.
- 230 Volt Euro power socket:
 - Do not plug in devices or connectors that are too heavy (e.g. a transformer) into the power socket.
 - Do not connect lamps which contain a neon tube.
 - Only plug appliances with a voltage that matches the power socket voltage into the power socket.
 - Where devices have with a high start-up current, surge protection prevents them from switching on. In this case, unplug

the device and try plugging it back in after around 10 seconds.

Note

- Some appliances may not work properly in the 230 Volt Euro power connector due to a lack of power (Watts).
- The 230 Watt Euro power connector can be modified for 115 Watt appliances and vice versa. Consult a specialist shop for advice on accessories to adapt the connector. SEAT recommends taking your car in for technical service.

Air conditioning

Air conditioning

Introduction

Viewing Climatronic information

The factory-fitted radio or navigation system screen briefly displays information relating to Climatronic.

The units of temperature measurement is displayed on the factory-installed radio or navigation system and, depending on the vehicle equipment, can be set using the **Configuration** menu on the instrument panel.

WARNING

Reduced visibility through the windows increases the risk of serious accidents.

- Ensure that all windows are free of ice and snow and that they are not fogged up preventing a clear view of everything outside.
- The maximum heat output required to defrost windows quickly is only available when the engine has reached its normal running temperature. Only drive when you have good visibility.
- Always ensure that you use the air conditioner and heated rear window to maintain good visibility.
- Never leave the air recirculation on for a long period of time. If the cooling system is

switched off and air recirculation mode switched on, the windows can mist over very quickly, considerably limiting visibility.

- Switch air recirculation mode off when it is not required.

WARNING

Stuffy or used air will increase fatigue and reduce driver concentration possibly resulting in a serious accident.

- Never leave the fresh air fan turned off or use the air recirculation for long periods of time; the air in the vehicle interior will not be refreshed.


CAUTION

- Switch the air conditioner off if you think it may be broken. This will avoid additional damage. Have the air conditioner checked by a specialised workshop.
- Repairs to the air conditioner require specialist knowledge and special tools. SEAT recommends taking your car in for technical service.
- Do not smoke when air recirculation is switched on in vehicles with an air conditioner. The smoke taken in could lie on the cooling system vaporiser and on the activated charcoal cartridge of the dust and pollen filter, leading to a permanently unpleasant smell.

Note

- When the cooling system is turned off, air coming from the outside will not be dried. To avoid fogging up the windows, SEAT recommends leaving the cooler (compressor) on. To do this, press the **A/C** button. The button lamp should light up.
- If the humidity and temperature outside the vehicle are high, condensation can drip off the evaporator in the cooling system and form a pool underneath the vehicle, this is completely normal and there is no need to suspect a leak.
- Keep the air intake slots in front of the windscreen free of snow, ice and leaves to ensure heating and cooling are not impaired, and to prevent the windows from misting over.

Controls

Read the additional information carefully  page 37

To switch a function on or off, press the appropriate button. Press the button again to switch off the function.

The LED on each control lights up to indicate that the respective function of a control has been switched on.

Some Climatronic controls may also be on the air conditioner control panel located in

the rear centre console. These controls are used to make the appropriate settings for the rear seats.

Note

- Not all Climatronic buttons are operational in REAR mode.
- The **REAR** button is locked in defrost mode.

Controls in the rear seats



Fig. 194 Centre console: details of the controls in the rear seats

Rotary control »» Fig. 194	Description
A	Temperature selector
B	Air flow regulator

Air conditioning user instructions

The interior cooling system only works when the engine is running and fan is switched on.

The air conditioner operates most effectively with the windows and the electric sliding panoramic roof closed. However, if the vehicle has heated up after standing in the sun for some time, the air inside can be cooled more quickly by opening the windows and the sliding electric panoramic sunroof briefly.

Setting for conditions of optimal visibility

When the air conditioning is switched on, the temperature and the air humidity in the vehicle interior drop. In this way, when the outside air humidity is high, the windows do not mist over and comfort for the vehicle occupants is improved.

Electronic manual air conditioning

- Switch off the air recirculation »» page 179.
- Set the fan to the required setting.
- Turn the temperature control to the centre position.
- Open and direct all the air outlets in the dash panel »» page 178.
- Turn the air distribution control to the required position.

With Climatronic

- Press the **AUTO** button.
- Set the temperature to +22°C (+72°F).
- Open and direct all the air outlets in the dash panel »» page 178.

Climatronic: Switching the measuring units for temperature on the radio display or the navigation system installed with the default settings

Switching the temperature indication from Celsius to Fahrenheit on the radio display or the navigation system is carried out in the menu on the instrument panel »» page 31.

The cooling system does not switch on

If the air conditioning system cannot be switched on, this may be caused by the following:

- The engine is not running.
- The fan is switched off.
- The air conditioning fuse is blown.
- The outside temperature is lower than approximately +3°C (+38°F).
- The air conditioner compressor has been temporarily switched off because the engine coolant temperature is too high.

- Another fault in the vehicle. Have the air conditioner checked by a specialised workshop.

Special features

If the humidity and temperature outside the vehicle are high, **condensation** can drip off

the vaporiser in the cooling system and form a pool underneath the vehicle. This is normal and does not indicate a leak!

Note

After starting the engine, any residual humidity in the air conditioner could mist over the windscreen. Switch on the defrost function as

soon as possible to clear the windscreen of condensation.

Air vents

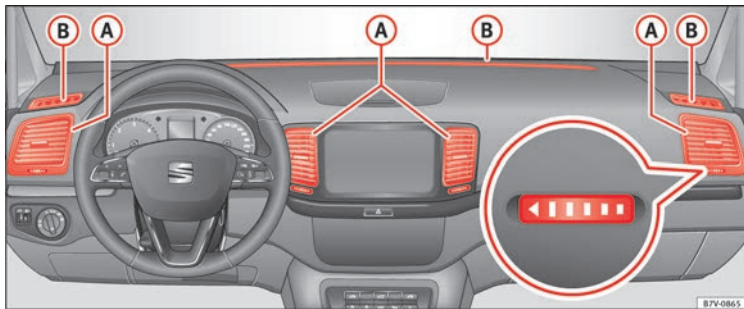


Fig. 195 Air vents in the dash panel

Air vents

Never close the air vents » **Fig. 195 (A)** completely to ensure heating, cooling and ventilation inside the vehicle.

- Turn the thumbwheel in the required direction to open and close the air vents. When

the thumbwheel is in the ► position, the corresponding air vent is closed.

- Change the air direction using the ventilation grille.

There are other air vents that cannot be adjusted on the dash panel **(B)**, in the footwell and in the rear area of the interior.

CAUTION

Never place food, medicines or other heat-sensitive objects close to the air vents. Being

heat-sensitive, they may be damaged or made unsuitable for use by the air coming from the air vents.

Note

The air from the vents flows through the vehicle interior and out through the outlets below the rear window. The slots must not be covered with items of clothing or other objects.

Air recirculation

Air recirculation mode prevents the ambient air from entering the interior.

When the outside temperature is very high, selecting manual air recirculation mode for a short period refreshes the vehicle interior more quickly.

For safety reasons, air recirculation mode is switched off when the **MAX** button is pressed or the air distributor turned to **»»»**.

Switching the recirculation mode on and off manually on the air conditioning (Electronic manual air conditioning)

Switching on: press the button until the lamp on the button lights up.

Switching off: press the button until the lamp on it is not lit up.

Switching the recirculation mode on and off manually on the Climatronic

Switching on: press the button until the lamp on the button lights up.

Switching off: press the button until the lamp on it is not lit up.

Automatic air recirculation mode

When in position, fresh air enters the vehicle interior. If the system detects a high concentration of hazardous substances in the ambient air, air recirculation mode is switched on automatically. When the level of impurities drops to within a normal range, recirculation mode is switched off.

The system is unable to detect unpleasant smells.

With the following outside temperatures and conditions the air recirculation **does not** switch on automatically:

- The cooling system is switched on (the button is lit up) and the outside temperature is below +3°C (+38°F).
- The cooling system and the windscreen wipers are switched off and the outside temperature is below +10°C (+50°F).
- The cooling system is switched off and the outside temperature is below +15°C (+59°F). The windscreen wiper is switched on.

Switching the automatic air recirculation mode on and off

Switching on: press the button until the right-hand lamp on the button lights up.

Switching off: press the button until no lamp on the button is lit up.

Switching the automatic air recirculation mode off temporarily

- press the button to temporarily switch to manual air recirculation mode in the event of unpleasant smells from outside. The left indicator lamp turns on.
- After more than two seconds, press the button again to restart automatic air recirculation. The right indicator lamp turns on.

WARNING

Observe the safety warnings **»»** in Introduction on page 176.

- If the cooling system is switched off and air recirculation mode switched on, the windows can mist over very quickly, considerably limiting visibility.
- Switch air recirculation mode off when it is not required. **»»**

ⓘ CAUTION

Do not smoke when air recirculation is switched on in vehicles with an air conditioner. The smoke taken in could lie on the cooling system vaporiser and on the activated charcoal cartridge of the dust and pollen filter, leading to a permanently unpleasant smell.

i Note

Climatronic: air recirculation mode switches on to prevent exhaust gas from entering the vehicle interior when it is in reverse and while the automatic windscreen wipers are working.

Auxiliary heater* (additional heater)

Introduction

The auxiliary heater is powered by fuel from the vehicle's fuel tank and can be used while the vehicle is in motion and at a standstill. Select the mode required (**heat** or **fan**) » page 182 on the dash panel.

In winter, the auxiliary heater can be used in **heat** mode before switching on the ignition to remove any ice, mist or snow from the windscreen (thin layers only).

⚠ WARNING

The auxiliary heater fumes contain carbon dioxide, an odourless and colourless toxic gas. Carbon monoxide can cause people to lose consciousness. It can also cause death.

- Never switch on the auxiliary heater or leave it running in places that are enclosed or unventilated.
- Never program the independent heating system to be activated and operated in closed, unventilated areas.

⚠ WARNING

The components of the auxiliary heater exhaust system heat up a great deal. This could cause a fire.


- Always park your vehicle so that no part of the exhaust system can come in contact with flammable materials (such as dried grass).

ⓘ CAUTION



Never place food, medicines or other heat-sensitive objects close to the air vents. Food, medicines and other heat-sensitive objects may be damaged or made unsuitable for use by the air coming from the air vents.

Switching the auxiliary heater on and off

Switching the auxiliary heater on:

	Manually using the instant on/off button.	» page 176
ON	Manually using the remote control.	» page 181
	Automatically at the programmed and enabled on time.	» page 182

Switching the auxiliary heater off:

	Manually using the instant on/off button for the air conditioner.	» page 176
OFF	Manually using the remote control.	» page 181
	Automatically after the programmed time.	» page 182
	Automatically, when the  lamp (fuel reserve) comes on.	» page 264
	Automatically when the battery power drops to a very low level.	» page 283

Special feature

After switching the auxiliary heater off, it continues to run for a short period to completely

burn any fuel remaining in the auxiliary heater. The exhaust gases are also extracted from the system.

Remote control

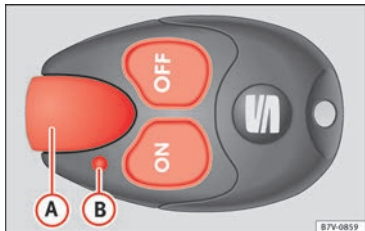


Fig. 196 Auxiliary heater: remote control

Fig. 196	Meaning
ON	Switch the auxiliary heater on.
OFF	Switch the auxiliary heater off:
A	Aerial.
B	Light.

The auxiliary heater may accidentally switch on if a button is pressed on the remote control by mistake. This may also occur outside the range of the remote control or if the light flashes.

Remote control light

The remote control light provides users with different information at the push of a button:

Battery light Fig. 196 B	Meaning
Lights up green for around two seconds.	The auxiliary heater has been switched on using the ON button.
Lights up red for around two seconds.	The auxiliary heater has been switched off using the OFF button.
Slowly flashes green for around two seconds.	No on ^{a)} signal has been received.
Quickly flashes green for around two seconds.	The auxiliary heater is locked. Possible causes: the fuel tank is almost empty, the battery charge is very low or there is a fault.
Flashes red for around two seconds.	No off ^{b)} signal has been received.
Lights up orange for around two seconds, then green or red.	The remote control battery is almost flat. However, the on or off signal has been received, respectively.
Lights up orange for around two seconds, then flashes green or red.	The remote control battery is almost flat. The on or off signal has not been received, respectively.

Battery light Fig. 196 B	Meaning
Flashes orange for around five seconds.	The remote control battery is flat. The on or off signal has not been received, respectively.

^{a)} Within its range, the remote control might not receive the signal sent by the vehicle receiver. In this case, the remote control will send an error message whether the auxiliary heater is on or off. Come closer to the vehicle and press the corresponding button on the remote control once again.

Replacing the remote control battery

If the light **»»» Fig. 196 **B**** on the remote control does not come on when the button is pressed, the remote control battery should soon be replaced.

The battery is located beneath a cover on the back of the remote control. Turn the slot to the left using a flat, blunt object (e.g. a coin). When changing the battery, use another battery of the same model and observe the polarity when fitting it **»»» 1**.

Range

The receiver is in the interior of the vehicle. The remote control, when fitted with new batteries, has a range of several hundred metres. Obstacles between the remote control and the vehicle, bad weather conditions and discharged batteries can considerably reduce the range of the remote control. **»»**

An optimum range is obtained by keeping the remote control vertical, with the aerial **» Fig. 196 A** pointing upwards. When doing so, do not cover the aerial with your fingers or with the palm of your hand.

There must be a *minimum* distance of 2 metres between the remote control and the vehicle.

ⓘ CAUTION

- The radio frequency remote control contains electronic components. Therefore, avoid getting it wet and being knocked and protect it from direct sunlight.
- Use of inappropriate batteries may damage the remote control. For this reason, always replace the used battery with another of the same voltage, size and specifications.

♻️ For the sake of the environment

- Please dispose of old batteries so that they do not harm the environment.
- The remote control battery may contain perchlorate. Observe the legal requirements for their disposal.

Programming the auxiliary heater

The heater or ventilation inside the vehicle can be programmed for a certain period.

Before programming, check that the day is correctly set in the **Auxiliary heater – day of the week** menu **»»** **△**.

Enabling the Auxiliary heater menu on the instrument panel

- From the main menu, select the **Auxiliary heater** sub menu and press the **(OK)** button on the windscreen wiper lever.
- **OR:** press the **<** or **>** arrow buttons on the multifunction steering wheel until the **Auxiliary heater** menu is displayed.

Menu options	Description
Switching on Switching off	The auxiliary heater can be set to come on automatically if required. To do so, select a timer: – The timer is displayed marked with a ⬇ . – Only one timer can be selected. If a timer has been selected, Prog. ON will be displayed on the screen. If <i>no</i> timer has been selected, the dash panel display will show Prog. OFF . – To modify the programmed timer, select another timer or select the Off option.
Timer 1 Timer 2 Timer 3	Three different timers (hh.mm) can later be selected using the On option. If the auxiliary heater is to be switched on for just a certain day of the week, select the day of the week and the time for the auxiliary heater to come on.

Menu options	Description
Duration	The operating time may vary between 10 and 60 minutes and can be set to 5-minute intervals.
Operating mode	Set to heat or ventilate the vehicle interior when the auxiliary heater is switched on.
Day	Set the current day of the week.
Factory settings	The predefined factory values for the functions of this menu are restored.
Back	This returns to the main menu.

Checking programming

If the **timer** has been switched on after switching the ignition off, the light on the **⏻** button will remain lit for around 10 seconds.

⚠️ WARNING

Never program the independent heating system to be activated and operated in closed, unventilated areas. The auxiliary heater fumes contain carbon dioxide, an odourless and colourless toxic gas. Carbon monoxide can cause people to lose consciousness. It can also cause death.

Operating instructions

The auxiliary heater exhaust system located below the vehicle must be kept clear of snow, mud and other objects. The exhaust gases must not be obstructed in any way. The exhaust gases generated by the auxiliary heater are removed via an exhaust pipe fitted underneath the vehicle.

On heating the vehicle interior, depending on the outside temperature the warm air is first directed at the windscreen and then to the rest of the vehicle interior through the air vents. If the air vents are turned towards the windows, for example, the form of air distribution may be affected.

Depending on the outside temperature, the temperature at which the auxiliary heater warms the vehicle interior may be somewhat higher if the heating or air conditioner temperature control is set to maximum before switching the heating on.

Depending on the engine, vehicles with auxiliary heater may be fitted with a second battery in the luggage compartment that is responsible for powering the auxiliary heater.

When will the auxiliary heater will not switch on?

- The auxiliary heater requires about as much power as the dipped beam headlights. If the battery charge is low, the auxiliary heat-

er will switch off automatically or will not even switch on. This avoids problems when starting the engine.

- The heater will switch on just once each time. The timer will also have to be switched back on every time it is required.

Note

- **Noise will be heard while the auxiliary heater is running.**
- **When the air humidity is high and the outside temperature low, the heating system may evaporate condensation from the auxiliary heater. In this case, steam may be released from underneath the vehicle. This is completely normal and there is no need to suspect a fault!**
- **If the auxiliary heater runs several times over a prolonged period, the vehicle battery may run flat. To re-charge the battery, drive the vehicle for a long distance. As a general rule, drive for as much time as the auxiliary heating was working.**

Driving

Stopping and starting the engine

Introduction

Immobiliser display

When an invalid key is used or in the event of a system fault, **SAFE** or **Immobiliser on** is displayed on the instrument panel. The engine cannot be started.

Pushing or towing

For technical reasons, the vehicle must **not** be push- or tow-started. Jump starting is preferable.

⚠ WARNING

Turning off the engine while driving will make stopping the vehicle difficult; this could even result in the loss of control causing an accident with serious consequences.

- The assisted braking and steering systems, the airbag system, seat belts and certain safety equipment are only active while the engine is running.
- The engine should only be switched off when the vehicle is at a standstill.

⚠ WARNING

While the engine is running or starting it could help reduce the risk of serious injury.

- Never start or leave the engine running in poorly ventilated or closed spaces. Exhaust gas contains carbon monoxide, a toxic, colourless and odourless gas. Carbon monoxide can cause people to lose consciousness. It can also cause death.
- Never leave the vehicle unattended if the engine is running. The vehicle could move off suddenly or something unexpected could happen resulting in damage and serious injury.
- Never use start boosters. Cold start sprays could explode or increase the engine speed unexpectedly.

⚠ WARNING

The components of the exhaust system reach very high temperatures. This could cause a fire and considerable damage.

- Always park your vehicle so that no part of the exhaust system can come in contact with flammable materials (such as wood, leaves, dried grass, spilled fuel, etc.).
- Do not apply additional underseal or anti-corrosion coatings to the exhaust pipes, catalytic converter, heat shields or the diesel particulate filter.

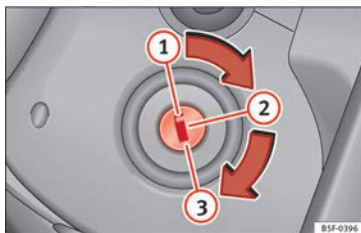
Ignition lock

Fig. 197 Vehicle key positions

Read the additional information carefully
»» page 25

Vehicle keys »» Fig. 197

No key in the ignition lock: The steering lock may be activated.

- ① Ignition off, all electrical devices disconnected. Key can be removed from the vehicle.
- ② Ignition is switched on. Pre-heating of diesel engine. The steering lock can be unlocked.
- ③ Switch on the engine. Release the key when the engine has started. When it is released, the key returns to position ②.

Key not authorised for the vehicle

If a key which is not authorised for this vehicle is inserted in the ignition lock, it can be removed as follows:

- *Automatic gearbox*: the key cannot be removed from the ignition lock. Press and release the selector lever locking button. Key can be removed from the vehicle.
- *Manual gearbox*: remove the key from the ignition.

⚠ WARNING

Unsuitable or careless use of the vehicle key could result in serious injury.

- Always take all the keys with you whenever you leave the vehicle. If not, the engine could accidentally be started and electrical equipment such as the windows could accidentally be operated which may result in serious injury.
- Never leave children or disabled people alone in the car. Passengers could be trapped in the car in an emergency and not be able to get themselves to safety. For example, depending on the time of the year, temperatures inside a locked and closed vehicle can be extremely high or extremely low resulting in serious injuries and illness or even death, particularly for young children.
- Never remove the key from the ignition if the vehicle is in motion. The steering may lock and it will not be possible to turn the steering wheel.

 Note

- If the key is left in the ignition lock with the engine off for long periods, the vehicle battery will run flat.
- For automatic gearbox vehicles, the key can only be removed from the ignition lock if the gear selector lever is in position P. In this case, press and release the selector lever locking button.

Starter button



Fig. 198 In the centre console: start-up push button for the Keyless Access lock and start-up system. The layout in right-hand drive vehicles is symmetrical.



Fig. 199 Emergency ignition in vehicles with Keyless Access.

The start-up button may only be used if there is a valid key in the vehicle.

Opening the driver's door **when exiting the vehicle** activates the electronic lock on the steering column if the ignition is disabled **»» page 198**.

Switching the ignition on/off

- Briefly push the start-up button **»» Fig. 198** without touching the brake or clutch pedal **»» ⚠**.

Emergency starting function

If no valid key is detected inside the vehicle, an emergency start-up will be required. The relevant message will appear in the dash panel display. This may happen when, for example, the vehicle key battery is very low or flat:

- Immediately after pushing the start-up button, keep the vehicle key next to the steering column **»» Fig. 199**.
- The ignition connects and the engine starts automatically.

Emergency disconnection

If the engine does not stop after briefly pressing the start-up button, an emergency disconnect will be required:

- Press the starter button twice within 1 second or press it once for more than 2 seconds **»» ⚠**.
- The engine turns off automatically.

Engine restart feature

If no valid key is detected inside the vehicle after the engine stops, you will only have 5 seconds to restart it. A warning will display on the dash panel screen.

After this interval, it will not be possible to start the engine without a valid key inside the vehicle.

WARNING

Any accidental movement of the vehicle could result in serious injury.

- **When pressing the start-up button, do not press the brake or clutch pedal, this way the engine will start immediately.** **»»**

WARNING

If vehicle keys are used negligently or without due care, this may cause accidents and serious injury.

- Never leave any key inside the vehicle when exiting. Otherwise, a child or unauthorised person could lock the vehicle, start the engine or connect the ignition and, in this way, operate electronic equipment (e.g. the windows).


Note

In diesel vehicles with the Keyless Access system, there may be a delay in the engine starting if it requires preheating.

Starting the engine

Complete operations only in the sequence given:

	Vehicles without Keyless Access	Vehicles with Keyless Access
1.	Press and hold the brake pedal until step 5 is performed.	
1a.	In vehicles with a manual gearbox: press and hold the clutch down until the engine starts.	
2.	Put the gearbox lever in neutral or the selector lever in position P or N.	

	Vehicles without Keyless Access	Vehicles with Keyless Access
3.	Only in vehicles with diesel engines: for preheating, turn the key in the ignition lock to position » Fig. 197 ② . A control lamp lights up on the dash panel  .	
4.	Turn the key in the ignition lock to position » Fig. 197 ③ ; do not press the accelerator.	Press the starter button » Fig. 198 ; do not press the accelerator. There needs to be a valid key inside the vehicle for the engine to start.
5.	Once the engine starts, release the key in the ignition lock.	Once the engine starts, release the start-up button.
6.	If the engine does not start, stop and wait for around 1 minute to try again.	If the engine does not start, stop and wait for around 1 minute to try again. If necessary, perform an emergency start » page 185 .
7.	Disconnect the electronic parking brake when you are about to start driving » page 188 .	

WARNING

Never leave the vehicle unattended if the engine is running. The vehicle could move off suddenly, especially if it is in gear, resulting in an accident and serious injury.

WARNING

Cold start sprays could explode or cause a sudden increase in the engine speed.

- Never use start boosters.

CAUTION

- An attempt to start the engine while driving or starting the engine immediately after turning it off can cause damage to the engine or starter motor.
- When the engine is cold, avoid high revs and heavy acceleration and do not make the engine work hard.
- Do not push or tow start the engine. Unburnt fuel could damage the catalytic converter.

For the sake of the environment

Do not warm the engine at idle speed; start driving immediately if the visibility is OK. This helps the engine reach operating temperature faster and reduces emissions.



Note

- For example, if the key battery is very worn or flat, the engine cannot be started with the starter button. In this case, remove the ignition button from the lock and insert the key.
- Electrical devices with a high power consumption are switched off temporarily when the engine starts.

- When the engine is started cold, there may be strong vibrations for a few moments for technical reasons. This is quite normal, and no cause for concern.
- At temperatures below +5°C (+41°F), smoke may be given off below the vehicle when the additional heater is turned on.

Stopping the engine

Complete operations only in the sequence given:

	Vehicles without Keyless Access	Vehicles with Keyless Access
1.	Bring the vehicle to a full stop »  .	
2.	Press and hold the brake pedal until the step 4 is performed.	
3.	If the vehicle has an automatic gearbox, place the selector lever in position P.	
4.	Connect the electronic parking brake » page 188.	
5.	Turn the vehicle key in the ignition lock to position » Fig. 197  .	Briefly press the start-up button » Fig. 198. If the engine fails to switch off, perform an emergency disconnect » page 185.
6.	If the vehicle is equipped with a manual gearbox, put it into 1st or reverse.	

WARNING

Never switch off the engine while the vehicle is moving. You may lose control of the vehicle and there is a risk of serious accident.

- The airbags and belt tensioners do not work when the ignition is switched off.
- The brake servo does not work with the engine off. To stop, the brake pedal must be pressed with more force.
- As the power steering does not work if the engine is not running, you will need more strength to steer than normally.
- If the key is removed from the ignition, the steering may lock and it will not be possible to steer the vehicle.

CAUTION

- If the vehicle is stopped and the Start-Stop system* switches off the engine, the ignition remains switched on. Make sure that the ignition is switched off before leaving the vehicle, otherwise the battery could discharge.
- If the engine has been driven at high speed for a prolonged period of time, it may overheat when turned off. To avoid engine damage, allow the engine to run for approximately two minutes in neutral before switching it off.

Note

- In vehicles with automatic gearbox, the key can only be removed when the selector lever is in position P.
- After stopping the engine, the engine compartment fan may continue running for a few minutes, even when the ignition has been switched off or the key removed. The radiator fan is automatically switched off.

Electronic immobiliser

The gear lock prevents the engine from being started with an unauthorised key and the vehicle being moved.

The vehicle key has a chip that automatically disables the immobilizer when the key is placed in the ignition lock.

The electronic immobiliser will be activated again automatically as soon as you pull the key out of the ignition lock. For vehicles with the Keyless Access system, the key has to be outside the vehicle » page 117.

For this reason, the vehicle can only be used with a genuine SEAT key with the correct code. Coded keys can be purchased from your technical service centre » page 112.

If an unauthorised key is used, the message **SAFE** or **Immobiliser active** is displayed on the instrument panel. The vehicle cannot be started in this case

Note

The correct operation of the vehicle is only guaranteed when original SEAT keys are used.


Braking and parking

Introduction

The **assisted braking systems** include the anti-lock braking system (ABS), the brake assist system (BAS), the electronic differential lock (EDL), the traction control system (ASR) and the electronic stability control (ESC).

WARNING

Driving with worn brake pads or a faulty brake system may lead to serious accident.

- If  lights, alone or accompanied by a warning message on the instrument panel display, please go immediately to a specialised workshop to check the brake pads and to replace them if they are worn.

WARNING

Careless parking can cause serious injury.

- Never remove the key from the ignition if the vehicle is in motion. The steering lock may engage and lock the steering wheel making the vehicle impossible to control.

- Always park your vehicle so that no part of the exhaust system can come in contact with flammable materials (such as wood, leaves, dried grass, spilled fuel, etc.).

- Always apply the electronic parking brake when you leave your vehicle and when you park.

- Never leave children or disabled people alone in the vehicle. They could release the electronic parking brake, activate the selector lever or gear stick and start the vehicle moving. This could result in a serious accident.

- Always take all the keys with you whenever you leave the vehicle. The engine could accidentally be started and electrical equipment such as the windows could accidentally be operated resulting in serious injury.

- Never leave children or disabled people alone in the car. They could be trapped in the car in an emergency and will not be able to get themselves to safety. For example, depending on the time of the year, temperatures inside a locked and closed vehicle can be extremely high or extremely low resulting in serious injuries and illness or even death, particularly for young children.






CAUTION

- Special care should be taken when parking in areas with high kerbs or fixed barriers. Objects protruding from the ground may damage the bumper or other parts of the vehicle

during manoeuvres. To avoid damage, stop before the wheels touch the barrier or kerb.

- Special attention is required when driving through entrances, over ramps, kerbs or other objects. The vehicle underbody, bumpers, mudguards and running gear, and the engine and exhaust system could be damaged as you drive over these objects.

Control and warning lamps

 It lights up red	
Together with the  control lamp on the button: Electronic parking brake on.	»» page 190
Fault in the brake system	 Stop the vehicle! Seek professional assistance! »» page 192.
Brake fluid level inadequate.	 Do not drive on! Check brake fluid level »» page 282.
Together with the ABS control lamp  : ABS fault.	Contact a specialised workshop. The vehicle can be braked without ABS.

 It lights up red	
Brake pedal not pressed!	Press brake pedal to the floor.

Driving



It lights up yellow

Front brake pads worn.

Contact a specialised workshop immediately. Inspect **all** the brake pads and replace as necessary.




It lights up yellow

ESC disconnected by the system.

Switching the ignition on and off if necessary, drive for a short distance.

Fault in the ESC.

Contact a specialised workshop.

Together with the ABS control lamp : Fault in the ABS.

Contact a specialised workshop. The vehicle can be braked without ABS.

The battery has been reconnected.

» page 283




It lights up yellow

ASR manually deactivated.



Switch on ASR » page 207. ASR is automatically activated when the ignition is switched on or off.



It lights up yellow


Together with the ESC control lamp : Fault in the ABS.

Contact a specialised workshop. The vehicle can be braked without ABS.

Together with the warning lamp  : ABS fault.



It lights up yellow

Together with the  warning lamp flashing: electronic parking brake faulty.

Contact a specialised workshop.



It lights up green



Brake pedal not pressed.

Press the brake pedal to select a gear range.

Press the brake pedal to disconnect the electronic parking brake » page 190.



Flashes red

Electronic parking brake faulty. At the same time the  control lamp may light up or the  control lamp on the button may flash.

Contact a specialised workshop, as it may not be possible to park the vehicle in safety.



It flashes yellow


ESC or ASR regulating.

Take your foot off the accelerator. Adjust your driving style to the road conditions.

Several warning and control lamps light up for a few seconds when the ignition is switched on, signalling that the function is being verified. They will switch off after a few seconds.




WARNING



Observe the safety warnings »  in Control and warning lamps on page 107.





WARNING

Driving with brakes in bad condition could result in a serious accident.

- If the brake warning lamp  does not turn off or if it lights up when driving, the brake fluid level in the reservoir is too low or there is a fault in the brake system. Obtain professional assistance immediately » page 281, Checking the brake fluid level.

- If the brake warning lamp  lights up together with the ABS warning lamp , the ABS regulation could be malfunctioning. As a result, the rear wheels can lock relatively easily when braking. If the rear wheels lock this could result in loss of vehicle control! If possible, reduce your speed and drive carefully to a specialised workshop close by to check the brake system. During the following journey, avoid sudden braking and manoeuvres.

- If the ABS warning lamp  does not go out or if it lights up while driving, the ABS is not working properly. The vehicle can only be stopped using normal braking without ABS. The protection provided by the ABS is not available. Visit a specialised workshop as soon as possible.

- If the  lights up, alone or accompanied by a warning message on the instrument panel »

display, please go immediately to a specialised workshop to check the brake pads and to replace them if they are worn.




Electronic parking brake






Fig. 200 Detailed view of the centre console: electronic parking brake switch

Applying the electronic parking brake

The parking brake can be applied whenever the vehicle is at a standstill, even when the ignition is switched off. Always apply the parking brake when you leave your vehicle and when you park.

- Pull the  button until the control lamp  on the button lights up.
- The parking brake is applied when the  control lamp lights up on the instrument panel » page 188.


Disengaging the electronic parking brake


- Switch the ignition on.
- Press the  button. At the same time, press the brake pedal hard or gently press the accelerator pedal with the engine switched on.
- The control lamps  on the button and  on the instrument panel go off.

Automatic release of the electronic parking brake on starting the engine

The electronic parking brake is automatically released when the vehicle starts moving, if the driver door is closed **and** the driver is wearing his/her seat belt. In addition, in vehicles with a **manual gearbox** the clutch pedal should also be pressed to the floor before starting the engine so that the system recognises that the parking brake should be released.

Emergency braking function

Only use the emergency braking function if the vehicle cannot be stopped with the brake pedal »  !


- Pull the  button for a longer duration to brake the vehicle **hard**. The warning display will be accompanied by the corresponding audible warning.
- To stop the braking process, release the button or press the accelerator.

WARNING

The incorrect use of the electronic parking brake may result in serious accident.

- **Never use the electronic parking brake to brake the vehicle except in an emergency. The braking distance is considerably longer, because braking is only applied to the rear wheels. Always use the foot brake.**
- **Never accelerate from the engine compartment with the engine running and a gear or a gear range engaged. The vehicle could move, even if the parking brake is applied.**

Note

- **In vehicles with a manual gearbox: when the clutch pedal is released and the accelerator pressed at the same time, the electronic parking brake is automatically released.**
- **If the vehicle battery is flat, it will not be possible to disconnect the electronic parking brake. Use the jump-start »  page 52.**
- **When the electronic parking brake is applied or released, noises may be heard.**
- **If the electronic parking brake has not been used for a long while, the system sometimes performs automatic and audible checks while the vehicle is at a standstill.**

Parking

When parking your vehicle, all legal requirements should be observed.

To park the vehicle

Complete operations only in the sequence given.

- Park the vehicle on a suitable surface »» ⚠.
- Press and hold the brake pedal until the vehicle comes to a standstill.
- Connect the electronic parking brake »» page 190.
- For an automatic gearbox, move the selector lever to position P.
- Switch off the engine and release the brake pedal.
- Remove the key from the ignition.
- If necessary, turn the steering wheel slightly to lock the steering.
- With a manual gearbox, engage 1st gear on flat ground and slopes, or even reverse gear on hills, and release the clutch pedal.
- Ensure that all passengers leave the vehicle, especially children.
- When leaving the vehicle, take all keys with you.
- Lock the vehicle.

Additional information for steep ascents and descents

Before switching off the engine, rotate the steering wheel so that if the vehicle should move, it will be held by the kerb.

- On slopes, turn the front wheels so that they are against the edge of the kerb.
- Uphill, turn the wheels towards the centre of the road.

⚠ WARNING

The components of the exhaust system reach very high temperatures. This could cause a fire and considerable damage.

- Always park your vehicle so that no part of the exhaust system can come in contact with flammable materials (such as wood, leaves, dried grass, or spilled fuel).

ⓘ CAUTION

- Special care should be taken when parking in areas with high kerbs or fixed barriers. Objects protruding from the ground may damage the bumper or other parts of the vehicle during manoeuvres. To avoid damage, stop before the wheels touch the barrier or kerb.
- Special attention is required when driving through entrances, over ramps, kerbs or other objects. The vehicle underbody, bumpers, mudguards and running gear, and the engine and exhaust system could be damaged as you drive over these objects.

Information on the brakes

For the first 200 to 300 km (100 to 200 miles), **new brake pads** have not yet reached

their maximum braking capacity, and need to be “run in” first »» ⚠. The slightly reduced braking effect can be compensated for by increasing pressure on the brake pedal. **While running in, the full braking distance or emergency braking distance is larger** than when the brake pads have been run in. While running in, avoid full power braking or situations requiring braking performance. For example, in heavy traffic.

The **rate of wear of the brake pads** depends to a great extent on the conditions in which the vehicle is used and the way the vehicle is driven. If the vehicle is used frequently in city traffic or for short trips or driven sport style, visit a specialised workshop regularly, more frequently than advised in the Maintenance Programme, to have the brake pads checked.

If you drive with **wet brakes**, for example, after crossing areas of water, in heavy rainfall or even after washing the car, the effect of the brakes is lessened as the brake discs are wet or even frozen (in winter). At higher speed, “dry” the brakes as quickly as possible by braking gently several times. Only do this without endangering vehicles behind you or any other road users »» ⚠.

A **layer of salt on the discs and brake pads** will reduce the effectiveness of the brakes and increase braking distance. If you drive for a prolonged period on salted roads without braking then brake carefully several times to eliminate the layer of salt on the brakes »» ⚠. »

If the vehicle remains parked for considerable lengths of time, is used little, or if the brakes are not used, there may be **corrosion** on the brake discs and a build up of **dirt** on the brake pads. If the brakes are not used frequently, or if rust has formed on the discs, SEAT recommends cleaning the pads and discs by braking firmly a few times at a moderately high speed. Only do this without endangering vehicles behind you or any other road users »» ⚠.

Faults in the brake system

During braking, if you notice that the vehicle does not react as usual (that the braking distance has increased suddenly) it may be possible that there is a fault in the braking system. The Ⓢ warning lamp lights up and a text message displayed. Take the vehicle to a specialised workshop immediately and have the fault repaired. Drive at a moderate speed and be prepared to use more pressure on the brake pedal, and allow for longer stopping distances.

Brake servo

The brake servo only operates when the engine is running and the pressure applied by the driver on the brake pedal increases.

If the brake servo does not operate or the vehicle must be towed, then the brake pedal will have to be pressed with more force given

that the braking distance will be increased when the brake servo does not operate »» ⚠.

⚠ WARNING

New brake pads do not brake to full efficiency.

- For the first 320 km (200 miles), new brake pads have not yet reached their maximum braking capacity, and need to be “run in” first. For this, to compensate for reduced braking efficiency the brake pedal will have to be pressed with more force.
- To avoid losing control of the vehicle and causing serious accidents, always take great care when driving with new brake pads.
- When running in new brake pads, always respect the safety distances between you and other vehicles and do not cause situations requiring extreme braking performance.

⚠ WARNING

When brakes overheat, braking is less efficient and braking distances increase.

- When driving on slopes, brakes can be overloaded and overheat quickly.
- Reduce speed or change down a gear when faced with steep and long slopes. This allows you to use the engine braking effect and to reduce the strain on the brake system.
- Non-standard or damaged front spoilers could restrict the airflow to the brakes and cause them to overheat.

⚠ WARNING

Wet, frozen or salt-covered brakes take longer to engage and this increases braking distances.

- Test the brakes carefully.
- Dry the brakes, free them of ice and salt by braking gently several times, when weather, road and traffic conditions permit.

⚠ WARNING

Driving without the brake servo may significantly increase the braking distance and result in a severe accident.

- Never allow the vehicle to move forwards when the engine is switched off.
- If the brake servo does not operate or the vehicle must be towed, then the brake pedal will have to be pressed with more force given that the braking distance will be increased when the brake servo does not operate.

ⓘ CAUTION

- Never make the brakes “slip” by pressing the pedal gently, if it is not really necessary to brake. Continuously pressing on the brake pedal will heat the brakes. This could significantly reduce braking power, increase braking distance or even result in the total failure of the brake system.
- Reduce speed or change down a gear when faced with steep and long slopes. This allows you to use the engine braking effect and to

reduce the strain on the brake system. Otherwise, the brakes may overheat and fail. Only use the brakes to reduce speed or to stop.

Note

When checking the front brake pads, take the time to also check the rear brake pads. The thickness of the brake pads should be checked visually and regularly, by looking through the openings in the wheel rims or from underneath the vehicle. If necessary, remove the wheels to check them thoroughly. SEAT recommends taking your car in for technical service.

Gearbox

Introduction

When reverse gear is engaged and the ignition is switched on the following takes place:

- Reverse lights light up.
- When reversing, the air conditioner automatically changes to air recirculation mode.
- The rear window heater switches on when the windscreen wiper is activated.
- Also, the parking sensor system, the optical parking sensor and the camera for the reverse assist system are connected.

⚠ WARNING

Rapid acceleration can cause loss of traction and skidding, especially on slippery ground. This could cause loss of control of the vehicle resulting in an accident and considerable damage.

- Only use the kick-down function or rapid acceleration if visibility, weather, road and traffic conditions so permit.

⚠ WARNING

Do not allow the brakes to “rub” for a prolonged period of time, or brake frequently or for long periods of time. Continuous braking heats up the brakes. This could significantly reduce braking power, increase braking distance or even result in the total failure of the brake system.

Control and warning lamps



It lights up red

Brake pedal not pressed!

Press brake pedal to the floor.



It lights up green

Brake pedal not pressed.

To select a range of gears, press the brake pedal. Please also see “Electronic parking brake” » page 188.



Flashes green

The selector lever locking button has not engaged. The vehicle does not start to move.

Engage the selector lever lock » page 195.

Several warning and control lamps light up for a few seconds when the ignition is switched on, signalling that the function is being verified. They will switch off after a few seconds.

⚠ WARNING

Observe the safety warnings » ⚠ in Control and warning lamps on page 107.

Manual gear change

Read the additional information carefully » 📖 page 35

In some countries, it is necessary to press the clutch pedal to the floor to start the engine.

Selecting reverse gear

Engage reverse gear only when the vehicle is stopped. »

⚠ WARNING

When the engine is running, the vehicle will start to move as soon as a gear is engaged and the clutch released. This is also the case with the electronic parking brake on.

- Never engage the reverse gear when a vehicle is moving forward.

ⓘ CAUTION

To prevent damage and avoid premature wear, please observe the following:

- While driving, do not leave your hand resting on the gear stick. The pressure applied by your hand is transmitted to the gearbox selector forks.
- Always ensure that the vehicle is completely stopped before engaging the reverse gear.
- When changing gear, always make sure the clutch pedal is pushed right to the floor.
- Never hold the vehicle “on the clutch” on hills with the engine on.

Automatic gearbox*

Fig. 201 Automatic gearbox selector lever with locking button (arrow)

Read the additional information carefully

» page 36

The selector lever has a lock. When changing the selector lever from position **P** to a range of gears, press the brake pedal and press the lock on the selector lever, located on the front part of the knob, in the direction of the arrow » **Fig. 201**. To move the gear selector lever from the position **N** to **D** or to **R**, first press and hold the brake pedal.

When the ignition is on, the current position of the selector lever is shown on the instrument panel.

P - Parking lock

The driven wheels are mechanically locked.

Only change gears when the vehicle is *at a standstill*. To change the position of the selector lever, press the brake pedal and switch on the ignition.

R - Reverse gear

Reverse gear is engaged.

Only put in reverse when the vehicle is *at a standstill*. If not it could result in serious damage.

N - Neutral

The gearbox is in neutral. No movement is transmitted to the wheels and the engine does not act as a brake.

D - Standard forwards driving position (normal programme)

The gears are changed (up and down) automatically. The gear shifts are determined by the engine load, your individual driving style and the speed of the vehicle.

S - Standard forwards driving position (sports programme)


The shift up to a higher gear is automatically *delayed* and the shift down is *faster* with respect to the **D** range of gears, to take full advantage of the engine power. The gear shifts are determined by the engine load, your individual driving style and the speed of the vehicle.

Selector lever locking

The gear selector lever lock prevents, in **P** or **N**, a gear selection from being inadvertently engaged and the vehicle moving off accidentally.

To release the gear selector lever lock, press and hold the brake pedal with the ignition on. Press simultaneously on the selector lever lock.

The selector lever lock is not engaged if it is moved quickly through position **N** (e.g. when shifting from **R** to **D**). This makes it possible, for instance, to “rock the vehicle backwards and forwards” if it is stuck in snow or mud. The selector lever lock engages automatically if the brake pedal is not pressed and the lever is in position **N** for more than about one second at a speed of less than 5 km/h (3 mph).

In vehicles with a DSG® automatic gearbox, on rare occasions the selector lever lock may not engage. In this case, the transmission is locked to prevent the vehicle from moving accidentally. The green control light  flashes and an information text is displayed. Proceed as follows to engage the selector lever lock:

- Press the brake pedal and then release.

WARNING

Placing the selector lever in an incorrect position may cause loss of control of the vehicle and a serious accident.

- Do not press the accelerator when engaging a range of gears.
- With the engine running and a range of gears selected, the vehicle will move off when the brake pedal is released.
- Never select reverse gear or the parking lock while driving.

WARNING

Unintentional movements of the vehicle could cause serious injury.

- As a driver, you should never leave your vehicle if the engine is running and a gear range is engaged. If you have to leave your vehicle while the engine is running, you must apply the electronic parking brake and engage parking lock **P** with the selector lever.
- While the engine is running and with the **D**, **S** or **R** range of gears selected, keep the brake pressed to keep the vehicle at a standstill. Transmission is not totally interrupted either when the vehicle is idling or when the vehicle “continues moving forwards”.
- Never engage the **R** or **P** gear ranges when the vehicle is moving.
- Never leave the vehicle with the gear selector in **N**. The vehicle may move downhill regardless of whether the engine is switched on or not.

CAUTION

If, when the vehicle is at a standstill, the electronic parking brake is not applied and the brake pedal is released while in position **P**, the vehicle may move a few centimetres forwards or backwards.

Note

If, while driving, the selector lever is accidentally placed in position **N**, lift your foot off the accelerator. Wait until the engine is running at idle speed before selecting a new gear range.

Gear change with Tiptronic*



Fig. 202 Selector lever in Tiptronic position (left-hand drive vehicles). The lay-out in right-hand drive vehicles is symmetrically opposed.

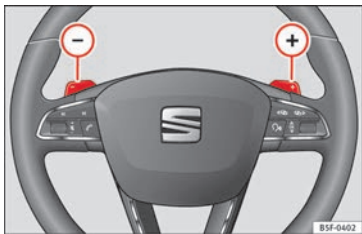


Fig. 203 Steering wheel with two paddle shifts for Tiptronic

The Tiptronic system allows you to manually change gears in vehicles with an automatic gearbox. When you change to the Tiptronic programme, the vehicle remains in the cur-

rently selected gear. This is possible as long as the system is not changing gear automatically due to a traffic situation.

Using Tiptronic with the selector lever

- Press the selector lever from position **D** to the right into the Tiptronic selector gate **»** **▲** in **Automatic gearbox* on page 195**.
- Press the lever forwards **⊕** or backwards **⊖** to move up or down a gear **» Fig. 202**.

Using the Tiptronic with the steering wheel paddle shifts

- In **D** or **S**, move the steering wheel paddle shifts **» Fig. 203**.
- Pull the right-hand side paddle **⊕** **» Fig. 203** towards the steering wheel to step up a gear.
- Pull the left-hand side paddle **⊖** **» Fig. 203** towards the steering wheel step down a gear.

If the paddles are not used for a period of time, the vehicle leaves Tiptronic mode.

⚠ CAUTION

- **When accelerating, the gearbox automatically shifts up into the next gear shortly before the maximum engine speed is reached.**
- **When reducing speed manually, the gearbox only shifts gear when the engine can no longer exceed the maximum engine speed.**

Driving with automatic gearbox

The gearbox changes gear ratios automatically as the vehicle moves.

Driving down hills

The steeper the gradient, the lower the gear you will need. The lowest gears increase the engine braking work. Never go down hills with the selector lever in neutral **N**.

- You should reduce speed accordingly.
- Press the selector lever from position **D** to the right into the Tiptronic selector gate **» page 196**.
- Gently pull the selector lever back to change down a gear.
- **OR:** reduce using the steering wheel paddles **» Fig. 203 » page 196**.

Back-up mode

If all the selector lever positions on the instrument panel display are shown with a light-coloured background, this means there is a fault in the system. The automatic gearbox will operate in back-up mode. When the backup programme is activated, it is possible to drive the vehicle, however, at low speeds and within a selected range of gears.

For the DSG® dual clutch gearbox, in some cases, this may mean that **the reverse gear does not engage**. The gearbox should be

checked by a specialised workshop as soon as possible.

Protection against overloading the DSG® 6-gear automatic gearbox

When the clutch is overloaded, the vehicle begins to *jerk* and the selector lever position indicator begins to flash. To prevent damage to the clutch, this interrupts the power transmission between the engine and the gearbox. There is no more traction and it is not possible to accelerate. If the clutch is opened automatically due to overloading, press the brake pedal. Wait a few seconds before starting to move again.

Kick-down

The kick-down system provides maximum acceleration when the gear selector lever is in the positions **D**, **S** or in the Tiptronic position.

When the accelerator pedal is pressed right down, the automatic gearbox will shift down to a lower gear, depending on road speed and engine speed. This takes advantage of the maximum acceleration of the vehicle » » ⚠.

When the accelerator is pressed to the floor, the automatic gearbox shifts to the next gear only after the engine reaches the specified maximum engine speed.

Launch-Control Programme

The Launch-Control programme enables maximum acceleration while at a standstill.

- Switch off the ASR » » page 188.
- Press and hold the brake pedal with your left foot.
- Place the selector lever in position **S** or Tiptronic.
- Press the accelerator with the right foot until the vehicle reaches an engine speed of approximately 3200 rpm.
- Lift the left foot off the brake » » ⚠. The vehicle starts with maximum acceleration.
- Turn on the ASR after accelerating!

⚠ WARNING

Rapid acceleration can cause loss of traction and skidding, especially on slippery ground. This could cause loss of control of the vehicle resulting in an accident and considerable damage.




- Only use kick-down and rapid acceleration when weather conditions, surface conditions and traffic conditions permit; accelerate and drive in a manner that does not endanger other road users.
- Please remember that the driven wheels can slip and the vehicle can skid if the ASR is turned off, especially on slippery ground.
- Turn on the ASR after accelerating!

ⓘ CAUTION

- If you stop on a hill with a gear range engaged, do not try to prevent the vehicle from rolling back by pressing on the accelerator. This could cause overheating and damage the automatic gearbox.
- Never allow the vehicle to move with the gear selector lever in **N**, especially with the engine turned off. The automatic gearbox will not be lubricated and could be damaged.

Recommended gear display

In some vehicles, the recommended gear for reducing fuel consumption is displayed on the instrument panel:

Display	Meaning
	Optimum gear.
	Recommendation to change up a gear.
	Recommendation to change down a gear.

Information for “cleaning” the diesel particulate filter

The exhaust gas system control recognises when the diesel particulate filter is blocked, and helps to clean it by recommending a specific gear for driving. It may therefore be » »

necessary to drive with the engine at an exceptionally high speed » page 202.

WARNING

The recommended gear display is intended as a guideline only; it should never replace the driver's attention to driving carefully.

- Responsibility for selecting the correct gear for each situation continues to lie with the driver, for example when overtaking, climbing a hill or towing a trailer.

For the sake of the environment

Selecting the most appropriate gear for the situation will help you to save fuel.

Note

The recommended gear display is switched off when the clutch pedal is pressed.

Address

Introduction

The power steering is not hydraulic but electromechanical. The advantage of this steering system is that it disposes of hydraulic tubes, hydraulic oil, the pump, filter and other components. The electromechanical system saves fuel. While a hydraulic system requires oil pressure to be maintained, electro-

mechanical steering only requires energy when the steering wheel is turned.


With the power steering system, the assisted steering function automatically adjusts according to the vehicle speed, the steering torque and the wheel turning angle. The power steering only works when the engine is running.


WARNING

If the power steering is not working then the steering wheel is much more difficult to turn and the vehicle more difficult to control.


- The power steering only works when the engine is running.
- Never allow the vehicle to move when the engine is switched off.
- Never remove the key from the ignition if the vehicle is in motion. The steering may lock and it will not be possible to turn the steering wheel.

Control and warning lamps

 It lights up red	
Power steering faulty.	The steering system should be checked by a specialised workshop as soon as possible.


 It lights up yellow	
Power steering operation reduced.	The steering system should be checked by a specialised workshop as soon as possible. If, after restarting the engine and driving for a short distance, the yellow warning lamp no longer comes on, it will not be necessary to take the vehicle to a specialised workshop.
The vehicle battery was disconnected and has been reconnected.	Drive for a short distance at 15-20 km/h (9-12 mph).

 Flashes red	
Fault in the steering column electronic lock.	 Do not drive on! Seek professional advice.

 It flashes yellow	
Steering column deviation.	Gently turn the steering wheel to and fro.
Steering wheel not unlocked or locked.	Remove the key from the ignition and then switch the ignition back on. Check the messages displayed on the instrument panel at the same time. Do not drive on, if the steering column remains locked after the ignition has been switched on. Seek specialist assistance.

Several warning and control lamps light up for a few seconds when the ignition is switched on, signalling that the function is being verified. They will switch off after a few seconds.

WARNING

Observe the safety warnings  in Control and warning lamps on page 107.

Information on the steering


Steering column electronic lock

Vehicles with Keyless Access: the steering column locks when the driver's door is opened and the ignition is switched off. Therefore, the vehicle should be at a standstill and, where applicable, the selector lever in position P.

If the driver door is opened before the ignition is switched off, the steering column electronic lock is activated via the ignition key or the sensor built into the door handle.

Steering column mechanical lock

To prevent theft, we recommend you lock the steering before leaving the vehicle.

Please engage steering lock	Unlocking the steering
Parking the vehicle  page 188.	Turn the steering wheel slightly to release the steering lock.
Remove the key from the ignition.	Insert the key in the ignition lock.
Turn the steering wheel slightly until you hear the steering lock.	Hold the steering wheel in this position and switch on the ignition.

Electromechanical power steering

With the power steering system, the assisted steering function automatically adjusts according to the vehicle speed, the steering torque and the wheel turning angle. The power steering only works when the engine is running.

You should remember that you will need considerably more power than normal to steer the vehicle if the power steering is not working correctly or not at all.

Counter steering assistance system

The counter steering assistance system helps the driver in critical situations. Additional steering power helps the driver when counter steering.

WARNING

The counter steering assistance system combined with ESC helps the driver to steer the vehicle in critical driving conditions. At all times, it is the driver who steers the vehicle. The counter steering system does not steer the vehicle.


Run-in and economical driving

Running in

Please observe the instructions for running-in new components.

Running-in the engine

The engine needs to be run-in over the first 1500 km (1000 miles). During its first few hours of running, the internal friction in the engine is greater than later on when all the moving parts have bedded down.

How the vehicle is driven for the first 1500 km (1000 miles) influences the future engine performance. Throughout the life of the vehicle, it should be driven at a moderate speed – especially when the engine is cold – this will reduce engine wear and increase its useful life. Never drive at extremely low engine speeds. Always engage a lower gear when the engine works “irregularly”. **For the first 1000 km or 600 miles, please note:** 

- Do not use full throttle.
- Do not force the engine above two thirds of its maximum speed.
- Do not tow a trailer.

Between 1000 and 1500 kilometres (600 to 1000 miles), gradually increase power until reaching the maximum speed and high engine speeds.

Running in new tyres and brake pads

- Replacement of wheel rims and new tyres »» page 287
- Notes on the brakes »» page 191



For the sake of the environment

If the engine is run in gently, the life of the engine will be increased and the engine oil consumption reduced.

Environmental compatibility

Environmental protection is a top priority in the design, choice of materials and manufacture of your new SEAT.

Constructive measures to encourage recycling

- Joints and connections designed for easy dismantling.

- Modular construction to facilitate dismantling.
- Increased use of single-grade materials.
- Plastic parts and elastomers are marked in accordance with ISO 1043, ISO 11469 and ISO 1629.

Choice of materials

- Use of recycled materials.
- Use of compatible plastics in the same part if its components are not easily separated.
- Use of recycled materials and/or materials originating from renewable sources.
- Reduction of volatile components, including odour, in plastic materials.
- Use of CFC-free coolants.

Ban on heavy metals, with the exceptions dictated by law (Annex II of ELV Directive 2000/53/EC): cadmium, lead, mercury, hexavalent chromium.

Manufacturing methods

- Reduction of the quantity of thinner in the protective wax for cavities.
- Use of plastic film as protection during vehicle transport.
- Use of solvent-free adhesives.
- Use of CFC-free coolants in cooling systems.

- Recycling and energy recovery from residues (RDF).
- Improvement in the quality of waste water.
- Use of systems for the recovery of residual heat (thermal recovery, enthalpy wheels, etc.).
- The use of water-soluble paints.

Economical and environmentally friendly driving

Fuel consumption, environmental impact and engine, brake and tyre wear depend largely on three factors:

- Personal driving style.
- Conditions of use (weather, road surface).
- Technical requirements.

Savings of up to 25% in fuel consumption are possible with an appropriate driving style and the adoption of certain simple tips.

Changing gear early

General instructions: The highest gear is always the most economical. As a guideline, for the majority of vehicles: at a speed of 30 km/h (19 mph), drive in third gear, at 40 km/h (25 mph) in fourth gear and at 50 km/h (31 mph) in fifth gear.

In addition, “skipping” gears when shifting up helps to save fuel, weather and traffic conditions permitting.

Do not wait until the last moment before changing gear. Only use first gear when you move off and change to second gear quickly. Avoid the kick-down function in vehicles with automatic gearbox.

Vehicles with a gear display help to achieve an economical driving style as the display indicates the best moment to change gear.

Let the vehicle roll

If you take your foot off the accelerator, the fuel supply is stopped and consumption is reduced.

Allow the vehicle to roll without accelerating, for example when approaching a red traffic light. However, if the vehicle is rolling too slowly or the distance is too long, the clutch pedal should be pressed to declutch. The engine will then operate at idle speed.

If the vehicle is going to be at a standstill for a period of time, switch off the engine; for example, while waiting at a level crossing. In vehicles which have the Start-Stop function on, the engine switches off automatically when the vehicle is not moving.

Think ahead and “flow” with the traffic

Frequent acceleration and braking considerably increase fuel consumption. If you think ahead as you drive and keep a safe distance from the vehicle in front, it is possible to slow down by simply lifting your foot off the accelerator. This eliminates the need for constant braking and acceleration.

Calm and steady driving

Constancy is more important than speed: The more you drive at a constant speed, the lower the fuel consumption.

When driving on the motorway, it is more efficient to drive at a constant and more moderate speed than to be continuously accelerating and braking. As a general rule, you will reach your destination just as quickly when you drive at a constant speed.

The cruise control function helps you to achieve a constant style of driving.

Moderate use of additional devices

It is important to travel in comfort, but convenience systems should be used ecologically.

Some equipment, when connected, increase fuel consumption considerably, for example:

- Air conditioning cooling system: If the air conditioning system is required to cool to significantly lower temperatures than the true

outside temperature, it will require a large amount of energy from the engine. Therefore, we recommend that the selected temperature for the vehicle is not too different to the outside temperature. It is a good idea to air the vehicle before starting your journey and to drive a short distance with all the windows open. Only then should you close all the windows and switch on the air conditioning. Keep windows closed when travelling at high speeds. Driving with the windows open increases fuel consumption.

- Switch off the seat heating when the seats have warmed up.
- Switch off the heated rear window and the windscreen heating when the windows have demisted and are free of ice.
- Do not leave the auxiliary heater switched on when the vehicle is moving ►► page 180.

Avoid short journeys

Fuel consumption is much higher when the engine is cold, immediately after it has been started. It takes a few kilometres of driving for the engine to warm up and to normalise consumption.

The engine and catalytic converter need to reach their proper **working temperature** in order to minimise fuel consumption and emissions. The **ambient temperature** has a decisive influence. ►►

Therefore, unnecessary short journeys should be avoided. Try to combine trips.

The vehicle uses more fuel in winter than in summer, even when other conditions are the same.

The engine takes a long time to warm up when it is idling. Mechanical wear and pollutant emissions are also especially high during this initial warm-up phase. It is therefore best to drive off immediately after starting the engine. Avoid running the engine at high speed.

Adjusting tyre pressures.

Having the correct pressure in your tyres helps to reduce rolling resistance and, as a result reduces fuel consumption. Increasing the tyre pressure slightly (+0.2 bar [2.9 psi/20 kPa]) can help to save fuel.

If you are prepared to accept a slight reduction in comfort, the tyres may be filled to the pressures recommended for a fully-loaded vehicle. This is also valid when driving alone without luggage.

When you buy new tyres, make sure they are optimised for minimum rolling resistance.

Avoid carrying unnecessary loads

The lighter the vehicle, the more economical and ecological the driving style. For example,

an additional weight of 100 kg will increase fuel consumption up to 0.3 l/100 km.

Remove any unnecessary objects or loads from the vehicle.

Remove optional equipment and unnecessary accessories

The more aerodynamic the vehicle, the lower the fuel consumption. Optional equipment and accessories (such as roof racks or bike carriers) reduce the aerodynamic benefits of the vehicle.

Therefore, we recommend you remove all optional and unnecessary equipment and racks, especially if you intend to drive at high speeds.

Other factors which increase fuel consumption (examples):

- Fault in engine management.
- Driving on hills.
- Trailer towing.

WARNING

Always adapt your speed and the distance to the vehicles ahead in line with visibility, weather conditions, the condition of the road and the traffic situation.

Engine management and exhaust gas purification system



Introduction


WARNING


The components of the exhaust system reach very high temperatures. This could cause a fire.


- Always park your vehicle so that no part of the exhaust system can come in contact with flammable materials (such as dried grass).
- Do not apply additional underseal or anti-corrosion coatings to the exhaust pipes, catalytic converter, heat shields or the diesel particulate filter.

Control lamps

	It lights up
fault in the petrol engine management.	Take the vehicle to a specialised workshop as soon as possible and have the engine checked.
	It lights up
Diesel engine glow plug system.	The engine glow plug system has been activated. The engine can be started straight away when the lamp switches off.

	Flashes
Fault in the diesel engine management.	If the lamp flashes while you are driving, have the engine checked by a specialised workshop as soon as possible.

	It lights up
Fault in the emission control system.	Reduce speed and drive carefully to the nearest specialised workshop to have the engine checked.

	Flashes
Combustion fault which could damage the catalytic converter.	Reduce speed and drive carefully to the nearest specialised workshop to have the engine checked.

	It lights up
Diesel particulate filter blocked	»» page 204

Several warning and control lamps light up for a few seconds when the ignition is switched on, signalling that the function is being verified. They will switch off after a few seconds.

WARNING




Observe traffic regulations when cleaning the diesel particulate filter while driving.

- **Only carry on driving if visibility, weather, road and traffic conditions so permit.**
- **Never endanger your safety or that of other road users.**

CAUTION


Always pay attention to any lit control lamps and to the corresponding descriptions and instructions to avoid damage to the vehicle.

Note

While the control lamps , , EPC or  or remain lit, there may be engine problems, fuel consumption may increase and the engine may lose power.

Catalytic converter

The catalytic converter permits the subsequent treatment of the exhaust gases thus reducing contaminating gas emissions. To ensure a longer working life for the exhaust system and catalytic converter in a petrol engine:

- Always use unleaded petrol.
- Never run the fuel tank completely dry.
- Do not top up with too much engine oil »» page 274.
- Do not tow-start the vehicle; use the starter cables »»  page 52.

If you should notice misfiring, uneven running or loss of power when the car is moving, reduce speed immediately. Have the car inspected by a specialised workshop. If this happens, unburnt fuel can enter the exhaust system and escape into the atmosphere. The catalytic converter can also be damaged by overheating.


For the sake of the environment


Even when the emission control system is working perfectly, there may be a smell of sulphur under certain conditions. This depends on the sulphur content of the fuel being used.

Diesel particulate filter


The diesel particulate filter removes soot particulates from the exhaust gas, retains and burns them. To assist the combustion process, SEAT recommends you avoid frequent short trips.

- Always use diesel with a low sulphur content »» page 267.
- Never use petrol or fuel oil.
- Never use biodiesel. However, a blend prepared by the diesel manufacturer containing biodiesel within the limits established by the EN 590 standard may be used »» page 267.
- Never run the fuel tank completely dry. »»





- Do not top up with too much engine oil
»» page 274.
- Do not tow-start the vehicle; use the starter cables »»  page 52.

In order to reduce blocking of the diesel particulate filter, some vehicles with an automatic gearbox may increase the engine speed slightly to start cleaning the filter automatically. The  control lamp will not light up in this case.

Control lamp

If the  control lamp lights up you should help the filter clean itself by driving in the appropriate manner.

To do this, drive about 15 minutes in fourth or fifth gear (automatic gearbox: **S** gear range) at a minimum speed of 60 km/h (37 mph), with the engine running at approximately 2,000 rpm. In this way, the soot build up in the filter is burned. When cleaning is successful, the control lamp turns off.

If the lamp  does not turn off, or the three lamps turn on (particulate filter , fault in the emission control system  and glow plugs ), drive the vehicle to a specialised workshop and have the fault repaired at the earliest opportunity.

WARNING

- **Always drive according to the road weather conditions, the terrain and traffic. Driving recommendations should never lead to illegal manoeuvres in surrounding traffic.**

For the sake of the environment

Even when the emission control system is working perfectly, there may be a smell of sulphur under certain conditions. This depends on the sulphur content of the fuel being used.

Driving tips

Driving abroad

In some countries, certain safety regulations and requirements are in force relating to exhaust gas emissions, which differ from the technical characteristics of the vehicle. Before travelling abroad, SEAT recommends you consult a technical service about the legal requirements and the following points:

- Does the vehicle need technical modifications for driving abroad, for example, adjustment of the headlamps?
- Does the vehicle have all the tools, diagnostics equipment and spare parts required for inspections and repairs?


- Are there any SEAT dealers in the destination country?
- For petrol vehicles: Is unleaded petrol available at the right octane rating?
- For diesel engines: Is diesel fuel available with a low sulphur content?
- Are a suitable engine oil (»» page 274) and other engine fluids complying with SEAT specifications available in the destination country?
- Will the navigation system fitted at the factory operate correctly in the destination country with the available navigation data?
- Are special tyres required in the destination country?

CAUTION

SEAT does not accept liability for any damage to the vehicle due to the use of a lower quality fuel, an inadequate service or the non-availability of genuine spare parts.

Driving along flooded roadways

To prevent damage to the vehicle when driving through water, for example, along a flooded road, please observe the following:

- Check the depth of the water before entering the flooded zone. The water should **never** come above the lower edge of the bodywork
»» .

- Do not drive faster than a pedestrian.
- Do not stop in the water, use reverse gear or switch off the engine.
- Oncoming traffic will cause waves which raise the level of the water, making it difficult to cross the water.

The Start/Stop system must be deactivated when driving through flooded areas

WARNING

When driving through water, mud, melted snow, etc., please remember that due to damp or frozen brake discs and shoes in winter, the braking effect may be delayed, therefore the required braking distance is greater.

- “Dry the brakes and remove ice” by braking carefully. Ensure that you are not endangering other road-users or breaking traffic regulations in the process.
- After driving through water, avoid sudden sharp manoeuvres.

CAUTION

• Driving through flooded areas may severely damage vehicle components such as the engine, transmission, drive train or electrical system.

- Never drive through salt water as salt causes corrosion. Always rinse any parts of the vehicle which have been in contact with salt water.

Driver assistance systems

Braking and stability systems

Brake assist systems

The brake assist systems ESC, ABS, BAS, ASR and EDL only operate when the ignition is switched on. They contribute significantly to increasing active safety.


Electronic Stability Control (ESC)

ESC reduces the risk of skidding and increases the vehicle stability by braking individual wheels under specific driving conditions. ESC detects critical handling situations, such as understeer, oversteer and wheelspin on the driven wheels. The system stabilises the vehicle by braking individual wheels or by reducing the engine torque.

The ESC has limits. It is important to realise that the ESC is also subject to the laws of physics. ESC will not be able to deal with all situations with which drivers may be faced. For example, if the road surface changes suddenly then ESC will not be useful in all cases. If the vehicle suddenly enters a section covered by water, mud or snow then ESC will not provide assistance in the same way as on dry ground. If the vehicle loses its grip on the ground and moves on a film of water (“aquaplaning”), the ESC will not be able to assist

the driver to control the vehicle as the loss of adherence with the road surface will prevent braking and steering. If the vehicle is driven through series of bends at high speed, the ESC will not always be as effective: the vehicle reaction to aggressive driving is not the same as at reduced speeds. When driving with a trailer, ESC does not provide the same amount of vehicle control as without a trailer.

Adjust your speed and driving style to road, traffic and weather conditions. ESC cannot push the limits of the laws of physics; improve the transmission available or maintain the vehicle on the road if a lack of driver attention creates an inevitable situation. Otherwise, ESC assists in maintaining vehicle control in extreme situations and uses the movements of the steering made by the driver to maintain the vehicle moving in the desired direction. If the vehicle is driven at such a speed that it will leave the road before ESC can intervene then the system cannot provide assistance.

The ABS, BAS, ASR and EDL systems are incorporated into the ESC. The ESC is always on. The ESC should only be turned off using the ASR button  **Fig. 204** when traction is insufficient. Always remember to turn on the ASR once more when the vehicle has traction again.



Anti-lock system (ABS)

ABS can prevent the wheels from locking during braking until just before the vehicle stops thus helping the driver to steer the vehicle and maintain control. This means that, even during full braking, the risk of skidding is reduced:

- Press and hold the brake pedal fully. Do not remove your foot from the brake pedal or reduce braking force!
- Do not “pump” the brake pedal, or reduce braking force!
- Maintain vehicle direction when braking fully.
- When the brake pedal is released or when the brake force is reduced, ABS is turned off.

ABS control can be observed by **vibration of the brake pedal** and noise. You should never expect the ABS to reduce the braking distance under *any* circumstances. This distance will increase when driving on gravel, recent snow or on icy and slippery ground.

When driving on loose ground, the all-terrain configuration of the ABS is automatically turned on. When ABS is activated, the front wheels may lock briefly. This shortens the braking distance in off-road situations as the wheels are prevented from digging into loose surfaces. All-terrain ABS only intervenes when driving in a straight line. When the

front wheels are turned, the normal ABS is activated.

Brake assist system (BAS)

The brake assist system may reduce the required braking distance. The brake assist system boosts the braking force if you press the brake pedal quickly in an emergency. As a result, the braking pressure increases rapidly, the braking force is multiplied and the braking distance is reduced. This enables the ABS to be activated more quickly and effectively.

Do **not** lift your foot off the brake pedal! When the brake pedal is released or when the brake force is reduced, braking assist automatically turns off the brake servo.

Traction control when accelerating (ASR)

In the event of wheelspin, the traction control system reduces the engine torque to match the amount of grip available. The ASR makes some situations easier, for example, when starting, accelerating or going uphill, even in unfavourable road conditions.

The ASR can be switched on or off manually
» page 207.

Electronic differential lock system (EDS)

EDL is available when driving in straight lines under normal conditions. When the EDL detects wheelspin, it brakes the spinning wheel

and directs the power to the other drive wheels. To prevent the disc brake of the braked wheel from overheating, the EDL cuts out automatically if subjected to excessive loads. The EDL will switch on again automatically when the brake has cooled down.

Electronic drive torque management (XDS)

When taking a curve, the driveshaft differential mechanism allows the outer wheel to turn at a higher speed than the inner wheel. In this way, the wheel that is turning faster (outer wheel) receives less drive torque than the inner wheel. This may mean that in certain situations the torque delivered to the inner wheel is too high, causing the wheels to spin. On the other hand, the outer wheel is receiving a lower drive torque than it could transmit. This causes an overall loss of lateral grip on the front axle, resulting in understeer or “lengthening” of the trajectory.

The XDS system can detect and correct this effect via the sensors and signals of the ESC.

Via the ESC, the XDS will brake the inside wheel and counter the excess driving torque of that wheel. This means that the driver's desired trajectory is much more precise.

The XDS system works in combination with the ESC and is always active, even when ASR traction control is disconnected.

⚠ WARNING

Driving at high speed on icy, slippery wet ground can result in loss of vehicle control and serious injury to the driver and passengers.

- Adjust your speed and driving style to visibility, road, traffic and weather conditions. Even though the brake assist systems, ABS, BAS, EDL, ASR and ESC, provide more security, do not take unnecessary risks while driving.

- Brake assist systems can not overcome the laws of physics. Even with ESC and other systems, slippery and wet roads will always be dangerous.

- Driving to quickly on wet ground can result in the wheels losing contact with the ground in an effect known as “aquaplaning”. Without adherence, it is impossible to brake, steer or control the vehicle.

- Brake assist systems cannot avoid accidents if, for example, the driver does not respect safety distances or drives to quickly in difficult conditions.

- Even though brake assist systems are extremely effective and help control the vehicle in difficult situations, remember that the vehicle stability depends on tyre grip.

- When accelerating on a slippery surface, for example on ice or snow, press the accelerator carefully. The wheels can still slip even with brake assist systems resulting in loss of vehicle control.

⚠ WARNING

The effectiveness of the ESC can be considerably reduced if other components and systems affecting driving dynamics are not maintained or are not functioning correctly. This includes, among others, brakes, tyres and other systems already mentioned.

- Remember that changing and fitting other components to the vehicle can affect operation of the ABS, BAS, ASL EDL and ESC.
- Changes to the vehicle suspension or using unapproved wheel/tyre combinations can affect operation of the ABS, BAS, ASL EDL and ESC, as well as their effectiveness.
- Likewise, the effectiveness of ESC depends on the use of suitable tyres » page 287.

i Note

- To ensure that the ESC and ASR work properly, all four wheels must be fitted with identical tyres. Any differences in the rolling radius of the tyres can cause the system to reduce engine power when this is not desired.
- If a malfunction should occur in the ABS, the ESC, EDL and ASR will also be out of action.
- Noises may be heard while any of the above systems are operating.

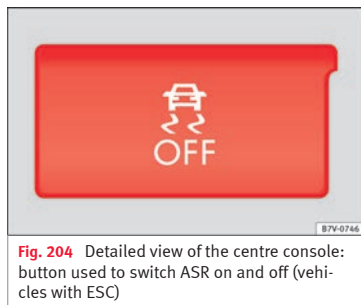
Switching ASR on and off

Fig. 204 Detailed view of the centre console: button used to switch ASR on and off (vehicles with ESC)

The electronic stability control ESC consists of ABS, EDL and ASR and only works when the engine is running.

The ASR can be switched off while the engine is running by pressing the **OFF** button » **Fig. 204**. The ASR (and similar) is only switched off when the required traction is not obtained:

- When driving through deep snow or on loose ground (gravel, etc.).
- When “freeing” a trapped vehicle.

Turn the ASR back on by pressing the **OFF** button » **Fig. 204**.

Start assist systems

Introduction

⚠ WARNING

The intelligent technology in the start assist systems cannot change the laws of physics. The improved comfort provided by start assist systems should not prompt you to take risks.

- Unintentional movements of the vehicle could cause serious injury.
- The start assist systems are not a replacement for driver awareness.
- Always try to adapt the speed of the vehicle and your style of driving to the condition of the ground or the road and to weather and traffic conditions.
- The start assist system cannot keep the vehicle stationary in all conditions on a gradient or cause it to brake on steep downhill gradients, e.g. if the road is slippery or icy.

Auto Hold function*



Fig. 205 Detailed view of the centre console: Auto Hold button

The control lamp on the button switches on when the Auto Hold function is on.

When the Auto Hold function is on, this helps the driver if they must regularly stop the vehicle or if they must stop with the engine running for prolonged periods, for example, on hills, before a traffic light or in traffic jams with continuous stopping and starting.

The Auto Hold function automatically prevents the vehicle from rolling away accidentally when at a standstill, without the driver having to keep his/her foot on the brake pedal.

When the system that detects that the vehicle has stopped, the Auto Hold keeps the vehicle at a standstill. The brake pedal can be released.

If the driver presses the brake pedal briefly or the accelerator to start off, the Auto Hold function releases the brake once more. The vehicle moves according to the gradient.

If any of the conditions necessary for the Auto Hold function change while the vehicle stopped, the system is turned off as is the indicator on the button **»» Fig. 205**. The electronic parking brake engages where necessary to park the vehicle safely **»» ⚠**.

Conditions for keeping the vehicle at a standstill with Auto Hold:


- The driver door must be closed.
 - The driver seat belt must be buckled.
 - The engine must be running.
 - The ASR system is switched on
- »» page 188.**

Automatically engaging and disengaging the Auto Hold function

If the Auto Hold function was engaged with the **(AUTO HOLD)** button before disengaging the ignition, the function will automatically remain engaged after the ignition is re-engaged.

If the Auto Hold function was not engaged, it will automatically remain disengaged after the ignition is engaged.

Permanent Auto Hold connection

The Auto Hold function must be switched on every time the engine is started. However, to switch the Auto Hold function on permanently, the **mark** must be switched on in the **Settings** menu, “Autohold” submenu
 »»  page 27.

Auto Hold works automatically under the following conditions:

All points must be fulfilled simultaneously

»» :

	Manual gearbox	Automatic gearbox
1.	If the vehicle is kept at a standstill using the brake pedal on a flat or a slope.	
2.	The engine must be “running smoothly”.	
3.	On a slope, the 1st gear is engaged uphill or the reverse gear is engaged for a downhill. The clutch must be held down.	A gear for driving is selected from R, D or S .
	Upon accelerating and pressing in the clutch simultaneously, the brake releases gradually.	Upon accelerating, the brake releases gradually.

Auto Hold turns off automatically under the following conditions:

	Manual gearbox	Automatic gearbox
1.	If one of the conditions mentioned in table on page 209 changes.	
2.	If the engine is “not running regularly” or if there is a malfunction.	
3.	When changing to idle speed.	If the selector lever is placed in neutral (N).
4.	If the engine is turned off or stalls.	If the engine is switched off.
5.	If the driver accelerates while pressing the clutch in.	If the vehicle is accelerated.
6.		When one of the wheels has minimal contact with the ground (e.g. on uneven ground).

WARNING

The Auto Hold technology is limited by the laws of physics. The improved comfort provided by Auto Hold should never prompt you to take risks.

- **Never leave the vehicle running and with the Auto Hold function switched on.**
- **Auto Hold cannot always stop the vehicle uphill and downhill (e.g. if the ground is slippery or frozen).**

CAUTION

Before entering an automatic car wash, always switch the Auto Hold function off, as it could be damaged when the electronic parking brake automatically engages.

Start-Stop Function*

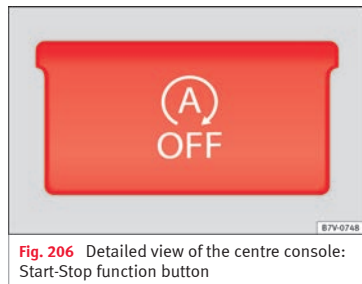


Fig. 206 Detailed view of the centre console: Start-Stop function button

With the Start-Stop system enabled, the engine is automatically stopped when the vehicle is at a standstill. The engine restarts automatically when required.

The function is enabled automatically whenever the ignition is switched on. The instrument panel displays information on the current status.

»»

Vehicles with a manual gearbox

- When the vehicle is at a standstill, leave it in neutral and take your foot off the clutch. The engine switches off.
- Simply depress the clutch pedal to move off again.

Vehicles with an automatic gearbox

- When the vehicle is at a standstill, depress the brake or keep it pressed down. The engine switches off.
- The engine will start again as soon as you release the brake pedal.
- With the selector lever set to position **P**, the engine will not start until a range of gears is selected or the accelerator pedal is depressed.

Important conditions for the engine to automatically switch off

- The driver seat belt must be buckled.
- The driver door must be closed.
- The bonnet must be closed.
- The factory-fitted towing bracket must not be electrically connected to a trailer.
- A minimum engine temperature has been reached.
- The steering wheel must not be turned more than 270 degrees.
- The vehicle has moved since the last stop.

- In vehicles with Climatronic: the temperature inside the vehicle is within the pre-set temperature range.
- The temperature set is neither very high nor very low.
- The air conditioning defrost function is not switched on.
- In vehicles with Climatronic: the blower has not been manually set to a high speed.
- The power level of the vehicle's battery is sufficient.
- The vehicle's battery temperature is neither too high nor too low.
- The vehicle is not on a steep gradient or slope.
- The front wheels are not overly turned.
- The heated windscreen is not switched on.
- Reverse gear is not engaged.
- The park assist system is not switched on.

Conditions for automatically restarting the engine

The engine may automatically restart under the following conditions:


- If the vehicle interior is too hot or too cold.
- If the vehicle moves.
- If the vehicle's battery voltage drops.

Conditions requiring the key to restart the engine

The engine must be started manually under the following conditions:

- If the driver unbuckles his/her seat belt.
- If the driver door is opened.
- If the bonnet is opened.
- In vehicles with a manual gearbox: if a gear has been selected.

Switching Start-Stop mode on and off manually

- Press the  button on the centre console **»» Fig. 206**.
- The button will light up when the Start-Stop function is switched off.

The engine will start immediately if the vehicle is in Stop mode when it is switched off manually.

WARNING

The brake servo and the power steering do not work when the engine is switched off.

- **Never allow the vehicle to move when the engine is switched off.**

CAUTION

Using the Start-Stop function for a long period at very high outside temperatures could damage the vehicle's battery.

Note

- In some cases, you may have to restart the vehicle using the key. Observe the corresponding message on the instrument panel display.
- If the steering wheel is turned more than 270°, Stop will not function; however, the angle of steering wheel turn does not affect starting the vehicle.

Parking distance warning system*

Introduction

The parking distance warning system assists the driver when parking. When the vehicle approaches an obstacle, forwards or backwards, an intermittent audible warning will be heard, higher or lower depending on the distance. The shorter the distance, the shorter the intervals between tones. If the vehicle is too close to the obstacle, the audible warning becomes constant.

If you continue to approach an obstacle when the sound is continuous, this means the system can no longer measure the distance.

The sensor system on the bumpers transmit and receive ultrasound. Using the ultrasound signal (transmission, reflection from the obstacle and reception), this system continu-

ously calculates the distance between the bumper and the obstacle.

WARNING

The parking distance warning system and the optical parking system cannot replace driver awareness.

- The sensors have blind spots in which obstacles and people are not registered.
- Always observe the area around the vehicle, as the sensors do not always detect small children, animals or objects.
- The surface of certain objects and some clothing do not reflect the ultrasound signals from the parking distance system. The system cannot detect or incorrectly detects these objects and people wearing these types of clothes.
- External sound sources can affect the parking distance aid signals. In this case, under certain circumstances, people and objects will not be detected.

CAUTION

- The sensors may not always be able to detect objects such as trailer draw bars, thin rails, fences, posts, trees and open boots, etc. This could result in damage to your car.
- Although the parking distance warning system detects and warns of the presence of an obstacle, the obstacle could disappear from the angle of measurement of the sensors if it is too high or low and the system would no

longer show it. Therefore, it will not warn you of these objects. Ignoring the warnings of the parking sensor system could cause considerable damage to the vehicle.

- The bumper sensors may become damaged or misaligned, for example, when parking.
- To ensure that the system works properly, the bumper sensors must be kept clean, free of ice and snow and uncovered.
- When cleaning the sensors with high-pressure or steam cleaning equipment, spray the sensors briefly at a distance of no less than 10 cm (4 inches).

Note

Acoustic sources may lead to erroneous warnings on the parking sensor system, e.g. rough tarmac, cobbles or the noise of other vehicles.

Parking distance warning system*

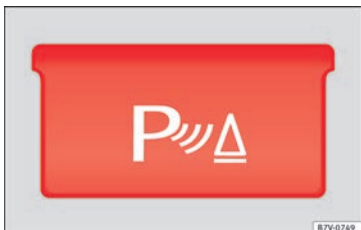


Fig. 207 Detailed view of the centre console: button for switching the parking distance warning system on and off



Fig. 208 Parking sensor system sensors on the front bumper

The parking distance warning system assists the driver when parking. If the vehicle is approaching an obstacle, an intermittent audible warning is emitted. The shorter the distance, the shorter the intervals between

tones. If the vehicle is too close to the obstacle, the audible warning becomes constant.

Switching the parking distance warning system on and off

- Press the **P** button when the ignition is switched on **»» Fig. 207**.
- *Automatic on:* select reverse gear.
- *Automatic off:* drive faster than 15 km/h (9 mph).

The button lights up when the function is switched on.

Things to note on the parking distance warning system

- The parking distance warning system sometimes registers water on the sensors as an obstacle.
- If the distance does not change, the warning signal will sound less loudly after a few seconds. If the continuous signal sounds, the volume will remain constant.
- When the vehicle moves away from the obstacle, the beeping sound automatically switches off. On approaching the obstacle again, the beeping sound will automatically switch back on.
- If the electronic parking brake is engaged or the selector lever is set to **P**, no audible warning will be emitted.

- Your technical service centre can adjust the volume of the warning signals.

Note

If the parking distance warning system is faulty, a constant audible warning will be emitted the first time it is switched on and the button will flash. Switch the parking distance warning system off using the button and take the vehicle to a specialised workshop to have the system checked as soon as possible.

Optical parking system* (OPS)

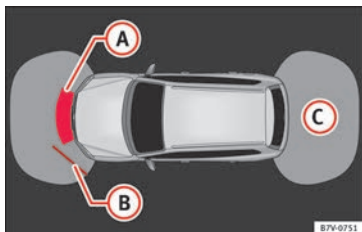


Fig. 209 On-screen OPS display: **A** has detected an obstacle in the collision zone; **B** has detected an obstacle in the segment; **C** zone recorded behind the vehicle.

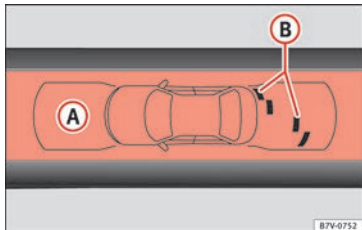


Fig. 210 On-screen OPS display: **A** has detected an obstacle in the segment; **B** restricted area in front of the vehicle.

The optical parking system is an accessory to the Parking distance warning system

» page 212 and the park assist system
» page 214.

The zone recorded by the sensors in front of and behind the vehicle is displayed on the factory-fitted radio or navigation system screen. Any obstacles are displayed in relation to the vehicle » ⚠.

Function	Necessary operations
Switching the display on:	Switch on the parking distance warning system » page 212 or the park assist system » page 214. The OPS switches on automatically.
Switching the display off manually:	Press a zone selection button on the factory-fitted radio or navigation system OR: briefly press the \rightarrow function button or (RVC) on the screen.
Switching the display off manually:	Drive forwards at more than about 10-15 km/h (6-9 mph). Select the reverse gear on vehicles with rear assist » page 217. The display changes to the image of the camera.

Zones explored

The zone in which obstacles are recognised runs to a distance of around 120 cm from the front of the vehicle and up to 60 cm to the side » Fig. 210 (B). Behind the vehicle, the zone analysed reaches a distance of up to 160 cm and around 60 cm to the sides » Fig. 209 (C).

Screen display

The image displayed represents the supervised zones in several segments. As the vehicle moves closer to an obstacle, the segment moves closer to the vehicle displayed » Fig. 209 (B) and » Fig. 210 (A). When the penultimate segment is displayed, this means that the vehicle has reached the collision zone. **Stop the vehicle!**


Distance from the vehicle to the obstacle	Audible warning	Displayed in colour on the screen: colour of the segment if an obstacle is recognised
Front: approximately 31-120 cm Behind: approximately 31-160 cm	Beeping sound	Yellow
Approximately 0-30 cm in front or behind ^{a)}	Permanent sound	Red

^{a)} The permanent sound starts at a somewhat greater distance on vehicles with a factory-fitted towing bracket.

With towing bracket

A specific image is displayed on the screen of vehicles with a factory-fitted towing bracket and an electrically connected trailer. In this case, the distances behind the vehicle are not indicated. »

Switching the parking sensor system sound on and off

If the  button on the radio or navigation system screen is pressed briefly, it may mute the sound of OPS warnings. To switch the warnings back on, press the button again briefly.

When the OPS is switched off and back on again, muting is cancelled. Error messages cannot be switched off.

WARNING

Do not be distracted from the traffic when looking at the screen.

Park Assist system* (Park Assist)

Related video





Fig. 211 Park Assist

87V-0883

Introduction

The Park Assist system helps the driver to find a suitable place to park, to insert the vehicle into parallel and perpendicular parking places and to leave parallel parking places.

The Park Assist system is limited to the system abilities and requires that the driver is especially attentive  .

The parking sensor system is a component of the Park Assist system that helps to park the vehicle.

For vehicles with the optical parking system (OPS), the radio navigation systems screen displays the detected zones in front of and behind the vehicle, indicating - within the limits of the system - the position of obstacles in relation to the vehicle.

The park assist system cannot be switched on if the factory-fitted towing bracket is electrically connected to a trailer.

WARNING

Despite the assistance provided by the park assist system, do not run any risks when parking. The system is not a replacement for driver awareness.

- Unintentional movements of the vehicle could cause serious injury.
- Adjust your speed and driving style to visibility, road, traffic and weather conditions.

- The surface of certain objects and items of clothing and external sound sources may have a negative effect on the park assist signals or on the system sensors or may not reflect its signals.
- The sensors have blind spots in which obstacles and people are not registered.
- Always observe the area around the vehicle, as the sensors do not always detect small children, animals or objects.

CAUTION

- The park assist system aims exclusively at other parked vehicles, without taking curbs or other circumstances into account. Make sure you do not damage the tyres and wheel rims when parking. Where necessary, stop manoeuvring to avoid damaging the vehicle.
- The sensors may not always be able to detect objects such as trailer draw bars, thin rails, fences, posts and trees, etc. This could result in damage to your car.
- Although the parking distance warning system detects and warns of the presence of an obstacle, the obstacle could disappear from the angle of measurement of the sensors if it is too high or low and the system would no longer show it. Therefore, it will not warn you of these objects. Ignoring the warnings of the parking sensor system could cause considerable damage to the vehicle. This is also valid when using the park assist (e.g. to park behind a truck or motorcycle). Therefore, always keep a close watch on the area in front of and

behind the vehicle while parking, and intervene promptly if necessary.

- To ensure that the system works properly, the bumper sensors must be kept clean, free of ice and snow and uncovered.
- The bumper sensors may become damaged or misaligned, for example, when parking.
- When cleaning the sensors with high-pressure or steam cleaning equipment, spray the sensors briefly at a distance of no less than 10 cm.

Note

Contact a specialised workshop with any system faults. SEAT recommends taking your car in for technical service.

Parking using the park assist system

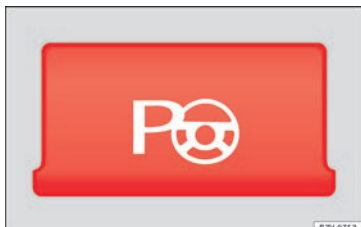





Fig. 212 Detailed view of the centre console: button to switch the park assist system on manually




Fig. 213 Gap detected: engage the reverse gear to park (parallel or nose/tail to the kerb)

Preparing to park

- The Traction control system ASR must be turned on »» page 188.
- **Parallel parking:** Press the  button at speeds up to 50 km/h (31 mph) **once**. When the function is enabled, the button »» **Fig. 212** will light up.

- **Perpendicular parking:** Press the  button at speeds up to 50 km/h (31 mph) **twice**. When the function is enabled, the button »» **Fig. 212** will light up.
- If necessary, press the  button once more to change parking mode.
- Apply the turn signal for the side on which a gap is to be detected for parking. The instrument panel displays the side corresponding to the road.



Parking

- **Parking parallel to the road:** drive next to the gap at a speed of no more than 40 km/h (25 mph) **and** at a distance of between 0.5 m and 2 m.
- **Parking perpendicular to the road:** drive next to the gap at a speed of no more than 20 km/h (12 mph) **and** at a distance of between 0.5 m and 2 m.
- The best parking results will be achieved if you position the vehicle as parallel as possible to the line of parked cars or the kerb.
- When a suitable parking place is displayed on the instrument panel, stop and select reverse gear.
- Follow the instructions given on the instrument panel display
- Then, release the steering wheel when the warning signal sounds »» : **The system will move the steering wheel! Observe the surrounding area.** »»

- Observe the surrounding area and accelerate carefully at a maximum of 7 km/h (4 mph).
- The park assist system is **only** responsible for moving the steering wheel during the manoeuvre. **The driver applies the accelerator, the clutch, the gears and the brake.**
- Follow the instructions given by the park assist system until the manoeuvre is completed.
- The park assist system steers the vehicle forwards and backwards until it is in a straight position in the parking space.
- The manoeuvre is complete when the corresponding indication is given on the instrument panel display.

Stopping the parking manoeuvre

The park assist system stops the manoeuvre in advance in the event of one of the following:

- Press the  button.
- Driving faster than 7 km/h (4 mph).
- The driver moves the steering wheel.
- The parking manoeuvre has not been completed after 6 minutes since the park assist system was activated.
- A sliding door is opened. To restart the manoeuvre, close the sliding door and press the  button again.


- There is a system malfunction (system temporarily unavailable).
- The ASR system is switched off or the ASR or ESC is working.


WARNING

The steering wheel turns quickly by itself when parking using the park assist system. Placing your hand between the steering wheel spokes could lead to injuries.

Note



- The park assist system has its limitations. For example, it is not possible to park on tight bends using the park assist system.
- Even if the park assist system recognises that there is not enough space for parking the vehicle, the instrument panel display will still show this place. In this case, the parking manoeuvre should not be requested.
- Changing gears between forward and reverse gears before indicated (that is, before the signal from the parking sensor system) the parking results may not be ideal.
- For parallel parking (parallel to the road), a sound will tell the driver when they must change from forward gears to reverse; the signal from the parking sensor system does not indicate changes of direction.
- The park assist can also be activated afterwards, if you pass close to a parallel parking space at a maximum of 40 km/h (25 mph) or close to a perpendicular parking space at

about 20 km/h (12 mph) and then press the  button.

- The progress bar on the screen of the instrument panel shows a display of the relative distance to be covered.
- When the Park Assist system is turning the steering wheel of the stopped vehicle the  symbol is also displayed. Press on the brake pedal so that the steering can turn with the vehicle at a standstill and thus reduce the number of manoeuvres.
- A “suitable” parking space length is at least 1.1 m greater than the length of the vehicle.
- If the results of the park assist system are not as good after changing the wheels, the system must memorise the perimeter of the new wheels. This process is performed automatically while the vehicle is in motion. To help this process, turn slowly (at less than 20 km/h [12 mph]), e.g. in an empty car park.

Leaving a parking space using the Park Assist system


Driving off

- Switch on the engine.
- Press button . When the function is enabled, the button  **Fig. 212** will light up.
- Apply the turn signal for the side on which you want to leave the parking space.
- Select reverse gear.

- Follow the instructions given by the park assist system.
- When the next indication appears, release the steering wheel » » ⚠ in Parking using the park assist system on page 216: **The system will move the steering wheel! Observe the surrounding area.**
- Observe the surrounding area and accelerate carefully at a maximum of 7 km/h (4 mph).
- The park assist system is **only** responsible for moving the steering wheel during the manoeuvre. **The driver applies the accelerator, the clutch, the gears and the brake.**
- When it is possible to leave the parking space, the Park Assist system will stop. Take control of the steering and when traffic conditions permit, leave the parking space.

Automatic stoppage of the manoeuvre

The park assist system stops the manoeuvre in the event of one of the following:

- Driving faster than 7 km/h (4 mph).
- The driver moves the steering wheel.
- A sliding door is opened. To restart the manoeuvre, close the sliding door and press the  button again.
- There is a system malfunction (system temporarily unavailable).
- The ASR system is switched off or the ASR or ESC is working.

⚠ WARNING

The steering wheel turns quickly automatically when leaving a parking space using the park assist system. Placing your hand between the steering wheel spokes could lead to injuries.

Park Assist brake operation

The Park Assist system helps the driver by braking automatically. Automatic braking does not relieve the driver of responsibility for controlling the accelerator, brake and clutch » » ⚠.

Braking to avoid damage at excess speed

It is possible that the system operates the brakes to reduce excess speed. The parking manoeuvre can then continue. The brakes will intervene during each parking process.

Braking to minimise damage

When approaching an obstacle, the vehicle may brake automatically. In certain circumstances (e.g. storm, detection of ultrasounds, vehicle status, load, inclination), the Park Assist system may stop the vehicle completely before an object.

- Press the foot brake » » ⚠ !

Following the intervention of the brakes, the Park Assist will stop.

⚠ WARNING

Despite the assistance provided by the park assist system, do not run any risks when parking. The system is not a replacement for driver awareness.

- Always be ready to brake.
- Automatic brake intervention will end after 1.5 seconds approximately. Following automatic intervention of the brakes, stop the vehicle yourself.

Rear assist* (Rear View Camera)

Introduction

The camera fitted to the rear lid helps drivers during parking or reversing manoeuvres. The camera image and certain orientation points generated by the system are indicated on the factory-fitted radio or navigation system screen.

Two types of location point (modes) can be selected:

- **Mode 1:** reverse parking perpendicular to the road (e.g. in a car park).

»

- **Mode 2:** reverse parking parallel to the curb.

The mode can be changed by pressing the button on the radio or navigation system screen. Only the mode to which the points can be changed will be displayed.

⚠ WARNING

Use of the camera to calculate the distance from obstacles (people, vehicles, etc.) is inaccurate and may cause accidents and severe injuries.

- The camera lens expands and distorts the field of vision and displays the objects on the screen in a different, vague manner.
- Some objects may not be displayed or may not be very clear (e.g. very thin posts or fences), due to the resolution of the monitor or if the light is dim.
- The camera has blind spots in which obstacles and people are not detected.
- Keep the camera lens clean and clear of snow and ice. Do not cover it.

⚠ WARNING

The intelligent technology in the rear assist system cannot change the limits imposed by the laws of physics and by the system itself. Careless or uncontrolled use of the rear assist system may result in severe injuries and accidents. The system is not a replacement for driver awareness.

- **Adjust your speed and driving style to visibility, road, traffic and weather conditions.**
- **Always keep a close eye on the area around the vehicle and always look towards where you are parking. The display shows the path of the rear end of the vehicle using the current steering angle. The front of the vehicle turns more in comparison with the rear.**
- **Do not be distracted from the traffic when looking at the screen.**
- **Always observe the area around the vehicle, as the cameras do not always detect children, animals or objects.**
- **The system might not show all areas clearly.**
- **Only use the rear assist system when the boot hatch is completely closed.**

ⓘ CAUTION

- The camera only displays 2D images on the screen. Due to the lack of depth, it might be difficult or impossible to recognise protruding objects or cracks in the road.
- The cameras may not always be able to detect objects such as thin rails, fences, posts and trees, etc. This could result in damage to your car.

Instructions for use



Fig. 214 On the rear lid: location of the rear assist camera.

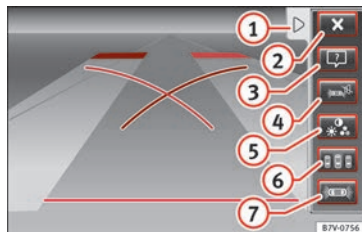


Fig. 215 Rear assist display: mode 2 connected

Function buttons on the screen:

- 1 ◀ display the menu; ▶ hide the menu.
- 2 ✕ Turning off the reversing camera images

- 3 Display help. The help list explains the surfaces and lines on the camera image. Press **↵** to exit help.
- 4 Mute the sound.
- 5 Adjust the display: brightness, contrast, colour.
- 6 Switching on the orientation points for rear parking perpendicular to the road (mode 1).
- 7 Displaying the optical parking system.

Operations in vehicles with no optical parking system (OPS)

Switching the display on automatically:	Select reverse gear with the ignition switched on or the engine running. Mode 1 will be displayed.
Switching the display off manually:	Press a button to select the area on the radio or the navigation system » Booklet Radio or » Booklet Navigation system. OR: press the X button on the screen. OR: after switching off the ignition, the rear assist image remains on the screen for a short period.
Switching off the display by disengaging reverse gear:	The image will switch off after around 10 seconds.
Switching off the display by driving forwards:	Drive forwards at more than approx. 15 km/h (9 mph).

Operations in vehicles with the optical parking system (OPS)

Switching the display on automatically:	Select reverse gear with the ignition switched on or the engine running. Mode 1 will be displayed.
Switching the display off manually:	Press a button to select the area on the radio or the navigation system » Booklet Radio or » Booklet Navigation system. OR: press the X button on the screen. OR: after switching off the ignition, the rear assist image remains on the screen for a short period. Press the P button.
Switching off the display by disengaging reverse gear:	The OPS display will immediately be shown.
Switching off the display by driving forwards:	Drive forwards at more than approx. 10 km/h (6 mph).

Things to note

1) Do not use the rear assist system in the following cases:

- If there is a fault in the dynamic chassis control (DCC).
- If the image displayed is not very clear or reliable (low visibility or dirty lens).
- If the space behind the vehicle cannot be clearly or completely recognised.

1) Do not use the rear assist system in the following cases:

- If the vehicle has been overloaded at the rear.
- If the driver is not familiar with the system.
- If the rear lid is open.
- If the position and installation angle of the camera have been changed, e.g. in a rear-end collision. Have a specialised workshop check the system.

2) Optical illusions of the camera (examples)

The rear assist camera produces two-dimensional images. Any cracks in or objects protruding from the ground or from other vehicles are more difficult to spot or cannot be seen due to a lack of depth in the image displayed.

Objects or other vehicles may seem to be closer or further away than what they really are:

- On changing from a flat surface to a slope or gradient.
- On changing from a slope or gradient to a flat surface.
- If the vehicle has been overloaded at the rear.
- On approaching protruding objects. These objects may be outside the angle of vision of the camera when reversing.

Cleaning the camera lens

Keep the camera lens clean and clear of snow and ice:

- Moisten the lens using a commercially available, alcohol-based glass cleaning



agent and clean the lens with a dry cloth » ❶.

- Remove snow using a small brush.
- Use de-icing spray to remove any ice » ❶.

❶ CAUTION

- Never use abrasive cleaners to clean the camera lens.
- Never remove snow or ice from the camera lens using warm or hot water. This could damage the lens.

❶ Note

- SEAT recommends that you practise parking with the rear assist system in a quiet location or in a car park to become familiar with the system, including the orientation lines and their function.
- The orientation lines will not be displayed on the screen if the rear lid is open or the factory-fitted towing bracket is electrically connected to a trailer.

Parking perpendicular to the road (mode 1)

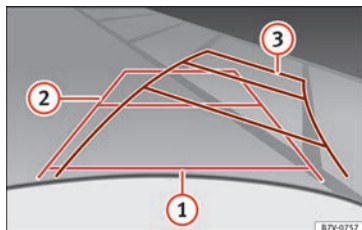


Fig. 216 Display: orientation lines for the parking space behind the vehicle

Summary of the orientation points

Meaning of orientation lines displayed on the screen » Fig. 216. All of the lengths of the orientation lines use a vehicle located on a horizontal surface as reference.

- ❶ Red: safety distance, i.e. road area located up to 40 cm behind the vehicle.
- ❷ Green: prolongation of the rear of the vehicle (somewhat enlarged). The area displayed green ends around 2 metres behind the vehicle, on the road.
- ❸ Yellow: prolongation of the rear of the vehicle as the steering wheel turns. The area displayed yellow ends around 3 metres behind the vehicle, on the road.

Parking

- Stop the vehicle in front of a space and select reverse gear.
- Reverse slowly and turn the steering wheel so that the yellow orientation lines guide you towards the space » Fig. 216 ❸.
- Align the vehicle straight in the parking place using the help of the green orientation lines.

Parking parallel to the road (mode 2)

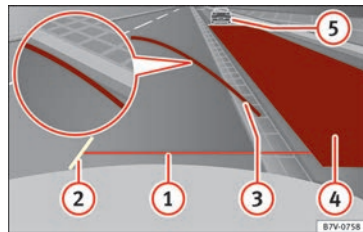


Fig. 217 Display: orientation lines and surfaces for the space behind the vehicle

After applying the turn signal, the lines and surfaces not required are deleted.

Summary of the orientation points

Meaning of orientation lines and surfaces displayed on the screen » Fig. 217. All of the

lengths of the orientation lines use a vehicle located on a horizontal surface as reference.

- ① Safety distance: road area located up to around 40 cm behind the vehicle.
- ② Vehicle side limit.
- ③ Turning point when parking. When the yellow line touches the curb or another limit of the parking space, the point for changing direction (magnifying glass) will have been reached.
- ④ Free space required to parallel park the vehicle. The surface displayed must completely fit in the space.
- ⑤ Possible vehicle parked next to the curb.

Parking

- Stop the vehicle 1 m away parallel to the parking space and select reverse gear.
- Switch on mode 2 on the navigation system screen for parallel parking.
- Slowly reverse and turn the steering wheel so that the surface displayed yellow on the screen stops in front of any obstacles ⑤ (e.g. another vehicle).
- Turn the steering wheel fully towards the space and reverse slowly.
- When the yellow line ③ touches the side limit of the space, e.g. the border or curb (magnifying glass), turn the steering wheel fully in the opposite direction.

- Continue reversing until the vehicle is inside the space, parallel to the road. Correct the position if necessary.

Cruise control* (Cruise control system - CCS)

Warning and control lamp

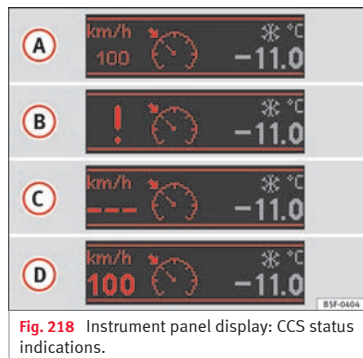


Fig. 218 Instrument panel display: CCS status indications.



It lights up

This cruise control system maintains the set speed of the vehicle.

Several warning and control lamps light up for a few seconds when the ignition is switch-

ed on, signalling that the function is being verified. They will switch off after a few seconds.

Indication on display

There are different versions of the cruise control system. In vehicles with the multifunction display (MFD), the set speed is displayed on the instrument panel screen.

Status Fig. 218:

- Ⓐ CCS temporarily switched off. The set speed is displayed in small figures.
- Ⓑ System error. Contact a specialised workshop.
- Ⓒ CCS switched on. The speed memory is empty.
- Ⓓ The CCS is switched on. The set speed is displayed in large figures.

⚠ WARNING

Observe the safety warnings » ⚠ in Control and warning lamps on page 107.

Cruise control system operation

Read the additional information carefully » 📖 page 33

The cruise control system (CCS) is able to maintain the set speed when driving forwards from approx. 20 km/h (12 mph).



The CCS only slows down by reducing the accelerator but not by braking »» ⚠.

Travelling down hills with the CCS

When travelling down hills the CCS cannot maintain a constant speed. Slow the vehicle down using the brake pedal and reduce gears if required.

Automatic off

The cruise control system (CCS) is switched off automatically or temporarily:

- If the system detects a fault that could negatively affect the operation of the CCS.
- If you drive above your set speed limit for a long time.
- When action is taken to adjust driving dynamics, e.g. by the ASR and ESC.
- If the airbag is triggered.
- If the brake pedal is pressed.
- If, in the case of the DSG® dual clutch gearbox, the selector lever is in the **R**, **P** or **N** position.
- If, in the case of a manual gearbox, 1st gear is engaged.
- If the clutch pedal is pressed for a long time.

⚠ WARNING

Use of the cruise control could cause accidents and severe injuries if it is not possible to drive at a constant speed maintaining the safety distance.

- Do not use the cruise control in heavy traffic, if the distance from the vehicle in front is insufficient, on steep roads, with several bends or in slippery circumstances (snow, ice, rain or loose gravel), or on flooded roads.
- Never use the CCS when driving off-road or on unpaved roads.
- Always adapt your speed and the distance to the vehicles ahead in line with visibility, weather conditions, the condition of the road and the traffic situation.
- To avoid unexpected operation of the cruise control system, turn it off every time you finish using it.
- It is dangerous to use a set speed which is too high for the prevailing road, traffic or weather conditions.
- When travelling down hills, the CCS cannot maintain a constant speed. The vehicle tends to accelerate under its own weight. Select a lower gear or use the foot brake to slow the vehicle.

Lane Assist system*

Introduction

⚠ WARNING

The intelligent technology in the lane assist system cannot change the limits imposed by the laws of physics and by the system itself. Careless or uncontrolled use of the Lane Assist system may cause accidents and injury. The system is not a replacement for driver awareness.

- Always adapt your speed and the distance to the vehicles ahead in line with visibility, weather conditions, the condition of the road and the traffic situation.
- Always keep your hands on the steering wheel so you can turn it at any time.
- The lane assist system does not detect all road markings. In some circumstances, the poor state of the road, structures located on it or certain objects may be mistakenly recognised as road markings by the lane assist system. In such situations, switch the lane assist system off immediately.
- Pay attention to the instructions on the instrument panel display and act accordingly to its requests.
- Always pay attention to the vehicle's surroundings.

Note

The lane assist system has been exclusively developed for driving on asphalted roads.



Note

If the lane assist system does not work as described in this chapter, do not use it and contact a specialised workshop.

Note


If you observe any system malfunction, have the system checked by a specialised workshop.

Control lamps

	Blinks or lights up yellow:
Lane assist system connected but inactive.	The system cannot clearly detect the lane. See page 223, The lane assist system is inactive (control lamp lit in yellow).
	Blinks or lights up green:
Lane assist system connected and active.	

Several warning and control lamps light up for a few seconds when the ignition is switched on, signalling that the function is being verified. They will switch off after a few seconds.

WARNING

Observe the safety warnings »  in Control and warning lamps on page 107.

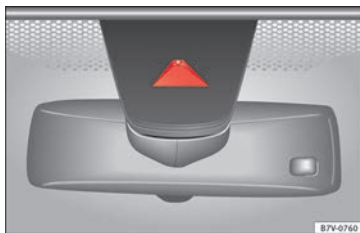
Operation mode

Fig. 219 In the windscreen: field of vision of the lane assist system camera.

Using the camera located in the sun visor, the lane assist system detects the possible lines dividing it. When the vehicle involuntarily approaches a dividing line it has detected, the system will notify the driver with a *corrective intervention*. It is possible to over-regulate the corrective intervention at any time.



If the turn signal is connected, there will be no warning as the lane assist system understands that you wish to change lanes voluntarily.

Steering wheel vibration

The following situations cause the steering wheel to vibrate and require the driver to take active control of the steering:

- If the limits inherent to the system are reached.
- If the maximum rotational torque during the corrective intervention is not enough to keep the vehicle inside the lane.
- If during the corrective intervention by the system the lane is no longer detected.

Switching the lane assist system on or off

- Select the corresponding menu option using the button for the driver assist systems »  page 27.
 - **OR:** activate or deactivate the system in the menu **Settings**, sub-menu **Assist systems**, menu **Lane Assist** »  page 27. The “confirmation sign” indicates that the driver assist system is switched on.
- Automatic deactivation:** the lane assist system can be deactivated automatically if there is a system malfunction. Control lamp switches off.
- The lane assist system is inactive (control lamp lit in yellow)**
- When driving speed drops to approx. 65 km/h (40 mph).

»

- When the Lane Assist system does not detect the dividing lines of the road. For example, in the event of road works, and snow, dirt, moisture or reflections.
- When the radius of a curve is too small.
- When there is no dividing line.
- When the distance to the next dividing line is excessive.
- When there are more than two lane markings per lane.
- When the ASR is switched off.
- When the system does not detect any active rotation of the steering wheel by the driver during a prolonged period.
- Temporarily, in the event of very dynamic driving.
- When the turn signal is connected.
- When more attention is required of the driver
- For very sporty driving
- In very unfavourable weather conditions
- In very unfavourable road conditions
- In areas of road works

Note

- **Before starting travel, verify that the camera's field of vision is not covered »» Fig. 219.**
- **Keep the camera window clean.**

Disconnect the lane assist system in the following situations

Due to the limits of the Lane Assist system, switch it off in the following situations:

Blind spot detector (BSD) with rear cross traffic alert (RCTA)

Related video



Fig. 220 Blind Spot Detector (BSD)

Introduction

The blind spot detector (BSD) helps detect the traffic situation to the sides and behind the vehicle.

The integrated parking assistant (RCTA) helps the driver when backing out of a parallel parking spot and in manoeuvring.

The blind spot detector has been developed for driving on paved roads.

WARNING

The smart technology incorporated into the blind spot detector (BSD) with parking assistance (RCTA) included cannot overcome the limits imposed by the laws of physics; it only works within the limits of the system. Accidents and severe injury may occur if the blind

spot detection system or the rear cross traffic alert are used negligently or involuntarily. The system is not a replacement for driver awareness.

- Adapt your speed and safe distance to the vehicle in front of you at all times to suit visibility, weather, road and traffic conditions.
- Keep your hands on the wheel at all times, and be ready to intervene in the steering at any time.
- Pay attention to the control lamps that may come on in the external rear view mirrors and on the instrument panel, and follow any instructions they may give.
- The blind spot assistant may react in the face of any special constructions that may be present on the sides of the vehicle: e.g., high or irregular protective fences. This may cause erroneous warnings.
- Never use the blind spot detector with rear cross traffic alert on unpaved roads. The blind spot detector with rear cross traffic alert has been designed for use on paved roads.
- Always pay attention to the vehicle's surroundings.
- Never use the blind spot detector with rear cross traffic alert if the radar sensors are dirty, covered or damaged. The system may work incorrectly in these cases.

CAUTION

- The radar sensors on the rear bumper may be damaged or shifted in the event of a collision,

for example, when entering or exiting a parking space. This may result in the system disconnecting itself, or at least having its functionality diminished.

- In order to ensure that the radar sensors work properly, keep the rear bumper free of snow and ice and do not cover it.
- The rear bumper should only be painted with paint authorised by SEAT. The blind spot detector's functions may be limited or work incorrectly if other paints are used.
- The external rear view mirror control lamps may have their functionality limited in the event of solar radiation.

Note

If the blind spot detector with rear cross traffic alert does not work as described in this chapter, do not use it and have it checked by a specialised workshop.

Control lamps

Control lamp in external rear view mirrors:


Lights up

Lights up once briefly: the blind spot detector is activated and ready to operate.


Lights up: blind spot detector has detected a vehicle in the blind spot.



Flashes

The blind spot detector has detected a vehicle in the blind spot and the turn signal has been turned on in the direction of the detected vehicle » .

For vehicles that are also equipped with Lane Assist » page 222, a warning to switch lanes will also appear even though the turn signal has not been engaged.

If there are no indications from the control lamp in the external rear view mirror, this means that the blind spot detector has not detected any other vehicles in the area »  **in Introduction on page 225.**

If the dipped beam is on, then the control lamps in the external rear view mirrors will be dimmed (night mode).

 **WARNING**

If the warning lamps and the corresponding messages are ignored when they light up, the vehicle may stall in traffic and cause accidents and severe injuries.

- Never ignore the warning lamps or messages.
- Carry out the necessary operations.

 **CAUTION**

Failure to heed the control lamps and corresponding text messages when they light up may result in damage to the vehicle.

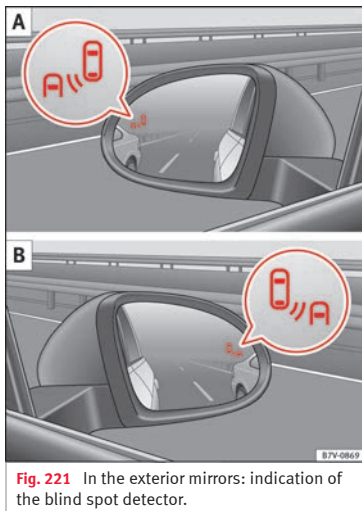
Blind spot detector (BSD)

Fig. 221 In the exterior mirrors: indication of the blind spot detector.



Fig. 222 Rear view of the vehicle: radar sensor zones.

The Blind spot detector uses radar sensors to monitor the areas to the side and behind the vehicle. The system does this by measuring the vehicle's distance from other vehicles and its speed differential. The blind spot detector will not work at speeds of less than approx. 15 km/h (9 mph). The system uses optical signals in the external rear view mirrors to notify the driver.

Indication in the external rear view mirrors

The control lamp (expanded view) provides an indication in the corresponding external mirror » **Fig. 221** regarding the traffic situation behind the vehicle, if it is deemed to be critical. The control lamp of the left-hand external mirror **A** indicates the traffic situation to the left of the vehicle, and the control lamp of the right-hand external mirror **B**, indicates the traffic situation to the right of the vehicle.

In the case of tinted windows or windows with tinted film, the indications of the external mirrors may not be seen clearly or correctly.

Keep the external mirrors clean and free of snow and ice, and do not cover them with adhesives or other similar materials.

Radar sensors

The radar sensor are located on the left and right of the bumper, and are not visible from

the outside »» Fig. 222. The sensors have a range of approx. 20 metres behind the vehicle, including the blind spots to the left and right of the vehicle. The range to the sides of the vehicle is roughly larger than the width of a lane.

The lane width is not detected individually, but is rather pre-configured in the system. Thus if you are driving in wide lanes or in between two lanes, the indications may be incorrect. Furthermore, the system can detect

vehicles driving in the lane next to you (if there are any), and can also detect stationary objects such as dividers, and thus give an incorrect indication.

Driving situations

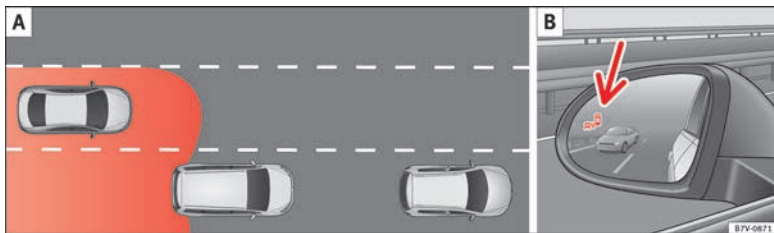


Fig. 223 Schematic diagram: **A** Passing situation with traffic behind the vehicle. **B** Indication from the blind spot detector in the left-hand external mirror.

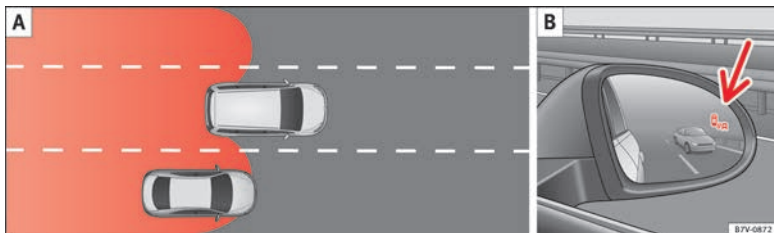


Fig. 224 Schematic diagram: **A** Situation of passing and then moving into the right-hand lane. **B** Indication from the blind spot detector in the right-hand external mirror.

In the following situations, an indication will be displayed in the external mirror »» **Fig. 223 B** (arrow) or »» **Fig. 224 B** (arrow):

- When being passed by another vehicle »» **Fig. 223 A**.
- When passing another vehicle »» **Fig. 224 A** with a speed differential of approx. 10 km/h (6 mph). If the vehicle is passing at a consid-

erably higher speed, no indication will be displayed.

The faster the vehicle approaches, the sooner an indication will be displayed in the external mirror, because the blind spot detector takes into account the speed differential with other vehicles. Thus even though the distance from the other vehicle is identical, the indication will appear sooner in some cases and later in others.

Physical limitations inherent to the system

In some situations the blind spot detector may not interpret the traffic situation correctly. E.g. in the following situations:

- on tight bends
- in the case of lanes with different widths
- at the top of slopes
- in adverse weather conditions

- in the case of special constructions to the side of the vehicle, e.g., high or irregular dividers

Parking assistant (RCTA)



Fig. 225 Schematic representation of the rear cross traffic alert: zone monitored around the vehicle exiting the parking space.

The rear cross traffic alert uses the radar sensors on the rear bumper »» **Fig. 222** to monitor the traffic crossing behind the vehicle as it backs out of a perpendicular parking space or as it is being manoeuvred, for example in very low visibility conditions.

If the system detects that someone else on the road is approaching the rear of the vehicle »» **Fig. 225**, an acoustic alarm will sound.

- In vehicles without ParkPilot a “gong” will sound and a message will be displayed on the instrument panel.
- If the vehicle is equipped ParkPilot, the ParkPilot acoustic alarm will sound continuously.

Automatic braking to reduce damages

If the rear cross traffic alert detects that someone else on the road is approaching the rear of the vehicle and the driver does not step on the brake, the system will engage the brakes automatically.

The parking system helps the driver by automatically engaging the brakes to reduce any damage. The system will brake automatically if the vehicle is reversing at a speed of approximately 1-12 km (1-7 mph). Once it has detected that the vehicle has stopped, the system will keep the vehicle stopped for approx. 2 seconds.

After automatically braking to reduce damage, the system will not be able to automatically brake again for approximately 10 seconds.

You can interrupt the automatic braking by stepping forcefully on the accelerator pedal or the brake pedal in order to regain control of the vehicle.

⚠ WARNING

The smart technology incorporated into the rear cross traffic alert cannot overcome the limits imposed by the laws of physics; it only works within the limits of the system. Do not let the extra convenience afforded by the rear cross traffic alert tempt you into taking any risks. The system is not a replacement for driver awareness.

- The system should never be used in limited visibility conditions or complicated traffic, e.g., in high-traffic areas or when crossing multiple lanes.
- Be sure to always be aware of the vehicle's surroundings, since the system is not guaranteed to detect things such as bicycles or pedestrians in all situations.
- The rear cross traffic alert itself will not brake the vehicle to a complete stop.

Using the blind spot detector (BSD) with rear cross traffic alert (RCTA)

Activating and deactivating the blind spot detector (BSD) with parking assistant (RCTA)

The blind spot detector with rear cross traffic alert can be activated or deactivated in the “Assistants” menu of the SEAT information system, or depending on the vehicle's equipment, by using the driver assistance key located on the headlight lever.

Open the **Assistants** menu.



- BSD
- Parking Assist.

If the verification box on the control panel is checked , the functionality will be automatically activated at ignition.

When the blind spot detector is ready to operate, the indications in the external mirrors will turn on briefly as confirmation.

The control lamp of the instrument panel indicates the system's status.

When the vehicle is restarted, the last adjustment in the system will remain active.

If the blind spot detector was automatically deactivated, it will only be possible to restart the system after turning the vehicle off and restarting it.

Automatic deactivation of the blind spot detector (BSD)

The radar sensors of the blind spot detector with rear cross traffic alert will be automatically deactivated when, among other reasons, one of the sensors is detected to be permanently covered. This may be the case if, for example, there is a layer of snow or ice in front of one of the sensors.

The relevant text message will appear in the dash panel display

Trailer mode

The Blind spot detector and the rear cross traffic alert will be automatically deactivated and it will be impossible to activate them if the tow hitch is electrically connected to a trailer or other similar object.

As soon as the driver starts to drive with a trailer connected electrically to the vehicle, a message will appear on the instrument panel display indicating that the blind spot detector and the rear cross traffic alert are deactivated. Once the trailer has been unhitched from the vehicle, if you want to use the blind spot detector and the rear cross traffic alert, you will have to reactivate them in the corresponding menu.

If the towing hitch is not factory equipped, then the blind spot detector and the rear cross traffic alert will have to be deactivated manually when driving with a trailer.

Traffic signal detection (Sign Assist)*

Introduction

Sign Assist can help the driver with information on speed limits or if overtaking is prohibited at that moment. The traffic signs and additional information detected by the system is represented in the dash panel display

and in the visual presentation of the navigation system map.

Applicable countries:

Sign Assist is accepted in the following countries:

Andorra, Belgium, Denmark, Germany, Finland, France, Ireland, Italy, Liechtenstein, Luxembourg, Monaco, Netherlands, Norway, Austria, Poland, Portugal, San Marino, Sweden, Switzerland, Spain, Czech Republic, United Kingdom, Vatican City.

WARNING

The traffic signs and instructions shown by Sign Assist may differ from the current traffic situation.

- The signs and highway code rules always take precedence over the instructions and display of Sign Assist.
- Adjust your speed and driving style to visibility, road, traffic and weather conditions.
- The system cannot always detect or correctly show all the traffic signs.

WARNING

The traffic sign detection is not a replacement for driver awareness.

- Adverse conditions of visibility, darkness, snow, rain and fog can cause the system not to show the traffic signs or to show them erroneously.

ⓘ CAUTION

- If old mapping data is used in the navigation system, this may cause the traffic signs to be shown incorrectly.
- In the route points mode (navigation by route points) of the navigation system, Sign Assist is only partly available.

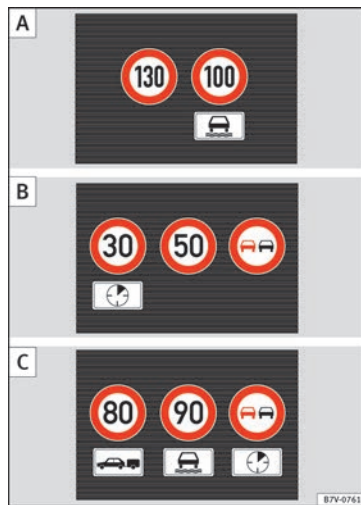
Indication on display¹⁾

Fig. 226 Instrument panel display: Examples of speed limits or overtaking prohibitions detected together with the corresponding additional signs

Display text of Sign Assist on the instrument panel

Error: Sign Assist	System fault. Have the system checked by a specialised workshop.
Sign Assist: Clean the windscreen!	The windscreen is dirty in the area of the camera. Clean the windscreen.
Sign Assist: only partly available at the moment.	No data is being transmitted from the navigator. Connect the navigator and insert the navigation data medium. ALTERNATIVELY: Sign Assist is not supported in the country in which you are driving at this time.

⚠ WARNING

If the warning lamps and messages are ignored, the vehicle may stall in traffic, or may cause accidents and severe injuries.

- Never ignore the warning lamps or text messages.
- Stop the vehicle safely as soon as possible. »

¹⁾ Depending on the version, the display may be in colour or black and white.

ⓘ CAUTION

Failure to heed the control lamps and text messages when they appear may result in vehicle faults.

Operation mode

Sign Assist does not work in all countries. This must be taken into account when travelling abroad.

Display of traffic signs

Speed limits or overtaking prohibitions together with the corresponding additional signs are shown on the instrument panel display » **Fig. 226**. Depending on the navigation system installed in the vehicle, traffic signs will be shown as above and also in the navigation system's map display.


When Sign Assist is connected, the vehicle records the traffic signs with a camera in the base of the interior rear vision mirror. After checking and evaluating the information from the camera, the navigation system and the current vehicle data, up to three valid traffic signs are displayed in conjunction with the corresponding additional signs. The traffic sign that is currently valid for the driver is shown first, in the left side of the screen. A traffic sign of only limited validity, e.g. **90 km/h** (56 mph) is shown second, together with the additional sign "if the road is

wet". If the vehicle's rain sensor detects rain during travel, the traffic sign valid at this moment will move to the first position along the additional sign "if the road is wet".


The permanent display on the instrument panel screen is shown as you pass the real traffic signs. The signs for entering and leaving towns activate the display of the usual speed limits for that country on roads in populated areas and national highways, even if the speed is not limited by an actual traffic sign.

The end of a prohibition or limitation is not displayed. If you exceed the speed limits shown, a warning will not appear. The system does not detect areas with little traffic. The current legal provisions apply.

Connection and disconnection

- Connect or disconnect the assist system in the **Settings** menu in the SEAT information system »  page 27.
- **OR:** press the button for the driver assist systems on the main beam lever.

Trailer

Connect or disconnect the secondary display for speed limits and overtaking bans that apply to trailers (trailer mode) in the **Settings** menu in the SEAT information system »  page 27.

Tiredness detection (recommendation to take a break)**Introduction****⚠ WARNING**

Do not let the extra convenience afforded by the tiredness detection function tempt you into taking any risks when driving. When making long trips, conveniently long breaks must be taken.

- The driver is responsible for determining their capacity to drive.
- Never drive when tired.
- The system does not always detect the tiredness of the driver. Please read the information provided in the section » page 233, Limited operation.
- In some situations the system may incorrectly interpret an intended manoeuvre as a sign of tiredness of the driver.
- In the event of the an episode called "microsleep" at the wheel, a strong warning is not in place!
- Observe the indications on the display of the instrument panel and act in accordance with them.

Note

- The tiredness detection function has only been designed for driving on motorways and wide roads.
- If there is a fault in the system, refer to a Specialised workshop to have the system inspected.

Function and operation

Fig. 227 On the instrument panel display: tiredness detection symbol

The tiredness detection function registers the behaviour of the driver at the wheel at the beginning of a journey and, using this, evaluates the tiredness. This is continually compared with the current behaviour at the wheel. If the system detects that the driver is tired, an audible warning using a “gong” is given and a symbol and complementary message on the instrument panel display are

shown »» **Fig. 227**. The on-screen message on the dash panel is displayed for 5 seconds and, where required, repeated again. The system stores the last message displayed.

The message that appears on the instrument panel display can be switched off by pressing the **OK** button on the multifunction steering wheel or on the window wiper lever »» **page 29**. Using the multifunction display »» **page 29** the message on the instrument panel display can be shown.

Conditions of operation

Behaviour at the wheel is only evaluated at speeds of above 65 km/h (40 mph).

Switching on and off

The system can be switched on or off in the **Assistants** menu. If an assistance system is switched on, this is indicated with a “mark”.

Limited operation

The tiredness detection function is subject to certain limitations. Therefore it is possible that in some driving situations behaviour at the wheel cannot be correctly interpreted. E.g. in the following situations:

- at speeds lower than 65 km/h (40 mph),
- in sections with corners,
- on roads in poor condition,

- in the event of adverse weather conditions,
- when a sporty driving style is employed,
- in the event of a major distraction for the driver,

The tiredness detection function switches off when the ignition is switched off or when the driver unbuckles their seat belt and opens the door. If driving for a long time under 65 km/h (40 mph), the system ceases to assess tiredness automatically. If driving speed is then increased, the behaviour at the wheel will again be evaluated.

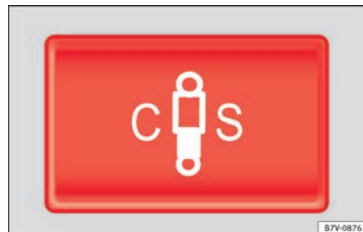
Dynamic Chassis control (DCC)***Operation and control**

Fig. 228 In the centre console: button for setting the dynamic chassis control.

DCC continuously adapts the suspension to the condition of the road and current driving conditions, according to the pre-set programme.

Steering is also adapted in the “Sport” programme.

Programme	Driving recommendations
“COMFORT” C	Adjust it to the most comfortable setting, for example, driving on surfaces in poor condition, or making long trips.
“NORMAL”	Balanced setting, suitable, for example, for day-to-day use.
“SPORT” S	Sport setting for sporty style driving

Select a program

- Switch the ignition on.
- Press the **C** **S** button repeatedly until the desired program is displayed

The “NORMAL” programme is active when **neither the C nor S** buttons are lit up.

WARNING

Switching the dynamic chassis control system on while the vehicle is in motion could divert your attention from the traffic and cause accidents.

WARNING

Adjusting the suspension can change driving properties. Dynamic chassis control must never lead to any kinds of risk.

- **Adapt your speed and driving style at all times to suit visibility, weather, road and traffic conditions.**

Note

If the dynamic chassis control does not operate as described in this chapter, go to an authorised workshop and request it be checked.


Note

In case of a fault in the dynamic chassis control, the buttons C and S will so indicate. A fault could affect driving comfort. Have the system checked by a specialised workshop.

Tyre monitoring systems

Introduction

The tyre monitor indicator monitors the tyre pressure of each wheel during driving using the ABS sensors. The ABS sensors monitor the tyre tread perimeter and vibrations of each tyre. The tyre monitor indicator warns the driver if it detects a considerable drop in tyre pressure of one or several tyres while

driving. Loss of tyre pressure will be indicated by the indicator  as well as an audible warning and sometimes a text message on the dash panel display. When you open the driver door, you will find a label indicating the tyre pressure recommended by the manufacturer for the maximum vehicle load for each tyre approved for the vehicle in question. By pressing the adjustment button on the tyre monitoring indicator, you may change the reference pressure for the tyres so that the tyre pressure coincides with actual pressure **» page 236.**

Suitable use of the adjustment button **» page 236.**

WARNING

Unsuitable handling of the wheels and tyres may lead to sudden tyre pressure losses, to tread separation or even to a blow-out.

- **Check tyre pressures regularly and ensure they are maintained at the pressures indicated. If the tyre pressure is too low, the tyres could overheat, resulting in tread detachment or even burst tyres.**
- **Tyre pressure should be that indicated on the label when the tyres are cold at all times **» page 291.****
- **Regularly check the cold inflation pressure of the tyres. If necessary, change the tyre pressure of the vehicle tyres while they are cold.**

- Regularly check your tyres for damage and wear.
- Never exceed the maximum permitted speed or loads specified for the type of tyre fitted on your vehicle.

WARNING

Incorrect use of the tyre monitoring indicator button could result in the indicator giving erroneous messages or prevented from indicating the danger caused by a defective tyre »» page 236.

CAUTION

- The tyre valves may be damaged if the cap is not in place. Check that the caps are identical to the standard caps and have been correctly tightened. Do not use metal caps »» page 236.
- Do not damage the valves when changing the tyres »» page 236.

For the sake of the environment

Under-inflated tyres lead to increased fuel consumption and tyre wear.

Note

- Do not only rely on the tyre monitoring system. Regularly check your tyres to ensure that the tyre pressure is correct and that the tyres are not damaged due to puncture, cuts,



tears and impacts/dents. Remove objects from the tyres only when the tyres have not been pierced by these.

- The tyre monitoring system is set to the tyre pressure recommended by the manufacturer and indicated on the label »» Fig. 252.



Elements of the tyre monitoring indicator

Tyre monitoring indicator with button.

See »» page 236.


- ▶ Control lamp  on the instrument panel.
- ▶ Button  SET on the centre console.
- ▶ Monitoring the tread of all tyres using ABS sensors (indirect measurement).
- ▶ Adjustable medium and full-load tyre pressures.
- ▶ Button to update the system when the tyre pressure is changed.

Control lamp

	Blinks or lights up
The tyre pressure of a wheel has dropped considerably in relation to the pressure set by the driver »» page 236.	 Stop the vehicle! Reduce your speed immediately! Stop the vehicle safely as soon as possible. Avoid sudden manoeuvres and braking! Check all tyres and pressures. Replace any damaged tyres.
System malfunction.	Consult a specialised workshop if the tyre pressure is correct and the lamp remains lit after switching the ignition off and back on again. Have the system checked there.

Several warning and control lamps light up for a few seconds when the ignition is switched on, signalling that the function is being verified. They will switch off after a few seconds.

WARNING

Observe the safety warnings »»  in Control and warning lamps on page 107.

WARNING

When the tyres are inflated at different pressures or at a pressure that is too low then a tyre may be damaged resulting in a loss of control of the vehicle and a serious or fatal accident.

- If the warning lamp (⚠) lights up, stop immediately and check the tyres.
- If the tyres are inflated at different pressures or if a tyre pressure is too low, this will increase tyre wear, negatively affecting vehicle stability and increasing braking distances.
- If tyres are inflated at different pressures or a tyre pressure is too low, a tyre may be damaged and burst resulting in a loss of control of the vehicle.
- The driver is responsible for ensuring that all of the vehicle tyres are correctly inflated to the right pressure. The recommended tyre pressure is indicated on the label » Fig. 252.
- The tyre monitoring system can only operate correctly if all of the tyres are inflated to the correct pressure when cold.
- Driving with tyres at the wrong pressure can damage them and result in an accident. Ensure that the tyre pressures of all the tyres correspond to the vehicle load.
- Before starting a journey, always inflate tyres to the correct pressure.
- If tyre pressure is too low then the tyre is subject to greater forces and it may be heated to such an extent that the tread can rupture and the tyre will burst.
- With an overloaded vehicle at high speed, the tyres can overheat and burst resulting in a loss of vehicle control.
- Tyre pressures which are too high or too low reduce the useful life of the tyre, affecting vehicle performance.

- If a tyre has not been “punctured” and does not have to be changed immediately, drive to the nearest specialised workshop at a moderate speed and have the tyre checked and inflated to the correct pressure.

Tyre monitoring indicator

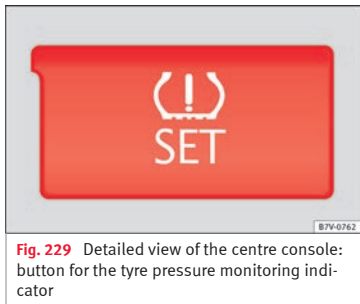


Fig. 229 Detailed view of the centre console: button for the tyre pressure monitoring indicator

The tyre monitor indicator compares wheel revolutions and, with this information, the tread of each wheel using the ABS sensors. If the tread of a wheel is changed, the tyre monitoring indicator will indicate as such on the instrument panel. The wheel tread changes when:

- Tyre pressure is insufficient
- Tyre structure is damaged

- The vehicle is unbalanced because of a load
- If the wheels on an axle are subject to a heavier load (e.g. when towing a trailer).
- The vehicle is fitted with snow chains
- The wheel on one axle is changed

There may be a delay in the reaction of the tyre monitoring indicator (⚠) or it may not indicate anything under certain circumstances (e.g. sports driving, snow-covered or unpaved roads).

Adaptation of the tyre monitoring indicator

On adjusting tyre pressure or changing one or more wheels, the » Fig. 229 button on the tyre monitoring indicator must be kept pressed down, with the ignition on, until an audible warning is heard. Do the same, for example, when the front and rear wheels are swapped » Fig. 251.

If the wheels are subjected to an excessive load (towing a trailer, heavy load), the tyre pressure must be increased to the maximum recommended pressure » page 287. Press the tyre monitoring indicator button to confirm the new pressure value.

Note

An incorrect warning may be given when snow chains are in use because the chains increase the tread of the wheel.

Towing bracket device

Driving with a trailer

Introduction

Always be aware of the legal requirements for each country to drive with a trailer and to use a tow hitch.

Your car is intended mainly for transporting passengers however, it can also be used to tow a trailer provided that it is fitted with the necessary equipment. The additional load has an effect on the useful life, fuel consumption and the vehicle performance and, in some cases, reduce the service intervals.

Driving with a trailer requires more force from the vehicle and, thus, more concentration from the driver.

For wintertime temperatures, fit winter tyres to the vehicle **and** the trailer.

Drawbar load

The *maximum* permitted Drawbar load exerted by the trailer drawbar on the ball joint of the tow hitch must not exceed **100 kg (approximately 220 lbs)**.

Vehicles with the Start-Stop function

With a SEAT factory fitted or retrofitted tow hitch, the Start-Stop function is automatically

deactivated when a trailer is connected. For tow hitches **not** installed by SEAT, the Start-Stop function must be deactivated manually using a button located on the dash panel **before** driving with a trailer and it must remain off for the entire journey»» ⚠.

⚠ WARNING

Never transport people in a trailer: this will endanger in their life and is against the law.

⚠ WARNING

The incorrect use of the tow hitch can cause accidents and injury.

- Only use a tow hitch in perfect condition and correctly installed.
- Never change or repair a tow hitch.
- To reduce the risk of injury in case of a reversing collision, injury to pedestrians and cyclists when parking, always keep the ball joint in when a trailer is not being used.
- Never fit a trailer tow hitch “that distributes the load” or “balances the load”. Your vehicle has not been designed for this type of tow hitch. The tow hitch may fail and the trailer will separate from the vehicle.

⚠ WARNING

Driving with a trailer and transporting heavy or large objects can affect vehicle handling and even cause an accident.

- Always secure loads correctly with suitable and undamaged attachment rope or straps.
- Adjust your speed and driving style to visibility, road, traffic and weather conditions.
- Trailers with a high centre of gravity can overturn more easily than those with a low centre of gravity.
- Avoid brusque manoeuvres and sudden braking.
- Always take the following precautions seriously.
- Reduce your speed immediately if you observe the trailer rocking from side to side.
- Never drive at more than 80 km/h (50 mph) when towing a trailer (or 100 km/h [62 mph] in exceptional circumstances). This also applies in countries where higher speeds are permitted. Always take the speed limits for vehicles with and without trailers in each country into account.
- Never try to stop the “snaking” by increasing speed.

⚠ WARNING

When driving with a trailer and using a tow hitch that was not installed by SEAT, the Start-Stop function must be manually deactivated. Otherwise, this could cause a braking anomaly that could result in an accident with serious consequences.

- Always manually deactivate the Start-Stop function when a trailer is being used on a tow hitch that has not been installed by SEAT. »»

 Note

- Always turn off the anti-theft alarm system before connecting or disconnecting a trailer »» page 119. Otherwise, the tilt sensor may erroneously activate the alarm.
- Never use a trailer with a new engine (for the first 1,000 km or 600 miles) »» page 247.
- At SEAT, we recommend folding in the tow hitch ball when a trailer is not being used. In case of a rear collision, the damage caused to the vehicle with the extended tow hitch ball could be more extensive.
- In some models, a tow hitch is necessary for towing vehicles. For this reason, you should store the tow hitch in the vehicle at all times.

Technical requirements

If the car is supplied with a **factory-fitted** towing bracket it will already have the necessary technical modifications and meet the statutory requirements for towing a trailer.

Only use an approved tow hitch for the gross trailer weight rating. The tow hitch must be suitable for both the vehicle and trailer and must be securely fitted to the vehicle chassis. Only use a tow hitch with a removable ball joint. Always check and take into account the tow hitch manufacturer's instructions. Never fit a trailer tow hitch "that distributes the load" or "balances the load".

Bumper mounted tow hitch

Never fit a tow hitch or its attachments to the bumper. A tow hitch should never interfere with the bumper performance. Do not modify the exhaust system and brake system. Regularly check the tow hitch to ensure it is firmly fitted.

Engine cooling system

Driving with a trailer increases the load on the engine and cooling system. The cooling system should always have sufficient coolant and to be able to cope with the vehicle and trailer.

Electric trailer brake

If the trailer has its own braking system, please note the relevant legal requirements. The trailer braking system should never be connected to the vehicle braking system.

Trailer cable

Always use a cable between the vehicle and the trailer »» page 240.

Trailer rear lights

The rear lights of a trailer must fulfil the corresponding standards »» page 240.

Never connect the trailer's rear lights directly to the vehicle electric system. In case of any doubt about the electrical connection of the

trailer, ask a specialised workshop. SEAT recommends visiting a technical service.

Wing mirrors

When the field of vision behind the trailer cannot be seen using the standard wing mirrors of the towing vehicle, additional wing mirrors are required according to the legal requirements of each country. The wing mirrors must be fitted before driving and must provide a sufficient field of vision behind.

Trailer electricity consumption

Never exceed the specifications:

Devices	Maximum power
Side lights and rear lights	50 Watts
Turn signal (each side)	54 Watts
Brake lights (total)	84 Watts
Reversing lights (total)	42 Watts
Rear fog light	42 Watts

WARNING

If the tow hitch is badly fitted or unsuitable, the trailer may separate from the vehicle causing an accident with serious consequences.

ⓘ CAUTION

- If the rear lights of the trailer are not correctly connected, the vehicle electronics may be damaged.
- If the trailer absorbs excessive electric current, the vehicle electronics may be damaged.
- Never connect the trailer's electric system to the electrical connections of the rear lights or any other power sources. Only use suitable connections for providing electric current to the trailer.

ⓘ Note

- Towing a trailer places additional demands on the vehicle. At SEAT, we recommend additional services between the normal inspection intervals if the vehicle is used frequently for towing a trailer.
- In some countries, an additional fire extinguisher is required if the trailer weight is more than 2500 kg

Electric tow hitch ball*

Fig. 230 Right-hand side of the luggage compartment: button to electrically release the tow hitch ball

The rotation radius of the tow hitch ball should be free of people, animals and objects » » ⚠.

The towing bracket is located in the bumper. The electric tow ball is fixed and cannot be removed.

Releasing and unfolding the tow ball

- Stop the vehicle and apply the electric parking brake.
- Switch the ignition off.
- Open the rear lid.
- Press the knob briefly » » **Fig. 230**. The tow ball is released electronically and folds out automatically; the button indicator will blink.

- Move the ball joint until it inserts and the button control lamp lights.
- Close the rear lid.
- Before hitching the trailer, remove the dust guard from the ball.
- The indicator only lights when the boot hatch is open and when a trailer is not hitched.

Restoring the tow ball to its originally position

- Stop the vehicle and apply the electric parking brake.
- Switch the ignition off.
- Remove the trailer and disconnect the cable between the vehicle and trailer. If necessary, remove the power socket adapter.
- Place the dust guard over the ball.
- Open the rear lid.
- Press the knob briefly » » **Fig. 230**. The tow ball is electronically released; the indicator blinks.
- Push the tow ball into the bumper until it locks in position and the button indicator lights.
- Close the rear lid.

»

The control lamp

- When the control lamp *flashes*, the tow ball is not in its final position, has not engaged or is damaged »» ⚠.
- When the control lamp *remains lit* and the rear lid is open, the tow ball has inserted correctly into the folded or deployed position.
- When the rear lid is closed, the indicator is turned off.

⚠ WARNING

The incorrect use of the tow hitch can cause accidents and injury.

- Ensure that no person, animal or object gets in the way of the tow ball.
- Never push the button when there is a tow hitched or when any kind of carrier or accessory is fitted to the tow hitch ball.
- While the ball is moving, do not interfere with any tool.
- Do not drive with a trailer if the control lamp does not light.
- If there is a fault in the electric system or the trailer tow hitch, visit a specialised workshop to have it checked.
- If the diameter of the tow hitch is less than 49 mm, never use this for a trailer.

⚠ CAUTION

- If anything is attached to the tow hitch ball, do not, under any circumstances press the button.
- Never direct a high-pressure or steam cleaning system directly at the tow hitch ball or trailer power socket. This could cause damage to seals or remove lubricating grease.

📄 Note

In extremely low temperatures, it is possible that the tow hitch is not released. In this case, place the vehicle in a warmer location (e.g. a garage).

Fitting a bicycle carrier on the mobile tow hitch ball

The maximum load permitted for a bicycle carrier on the tow hitch ball is **75 kg**, with a maximum distance of 30 cm from the support. The distance between supports is the distance between the bicycle carrier centre of gravity (with the bicycles) and the centre of point of the tow hitch ball.

⚠ WARNING

The incorrect use of the tow hitch with a bicycle carrier installed can cause accidents and injury.

- Never exceed the load and distances between supports indicated.
- Never fit the bicycle carrier to the tow hitch ball neck, underneath the tow hitch given that the bicycle carrier may be incorrectly fitted due to the shape of the tow hitch and the model of bicycle carrier.
- Always read and take the manufacturer assembly instructions into account.

⚠ CAUTION

- Exceeding the maximum load and distance between supports indicated can cause considerable damage to the vehicle.
- Never exceed the specifications.

Hitching and connecting the trailer

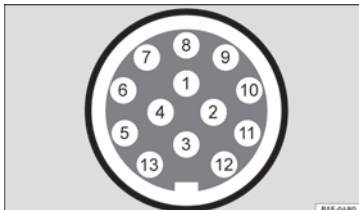


Fig. 231 Schematic diagram: assignment of the pins of the trailer's electrical socket.

Key of the Schematic diagram » Fig. 231:

Pin	Meaning
1	Left turn signal
2	Rear fog light
3	Earth, pins 1 to 8
4	Right turn signal
5	Rear light, right
6	Brake lights
7	Rear light, left
8	Reverse lights
9	Permanent live
10	Live charge cable
11	Unassigned
12	Unassigned
13	Earth, pins 9 to 13

Electrical socket for trailer

The vehicle is fitted with a 13-pole power socket for the electrical connection between the trailer and the vehicle. With the engine running, electrical devices on the trailer receive power from the electrical connection (pin 9 and pin 10 on the trailer power plug).

If the system detects that a trailer has been connected electrically, the electrical equip-

ment on the trailer will receive voltage through this connection (pins 9 and 10). Pin 9 has a permanent live. This powers, for example, the trailer's interior lighting. Electrical devices such as a fridge in a caravan **only** receive electrical power if the engine is running (through pin 10).

The earth wires, pin 3 and pin 13, should not be connected to each other to avoid overloading the electrical system.

If the trailer has a **7-contact connector**, you will need to use an adapter cable. In this case the function corresponding to pin 10 will not be available.

Trailer cable

Always secure the trailer cable to the towing vehicle correctly. Leave a little bit of slack in the cable for turning. However, ensure that the cable does not rub off the ground while driving.

Trailer rear lights

Check the trailer rear lights to ensure they work correctly and remain legal. Ensure that the trailer does not use more than the maximum power» page 238.

Trailer connected to the anti-theft alarm:

- When a vehicle comes from the factory fitted with an anti-theft alarm and tow hitch.

- When the trailer is connected to the vehicle using the socket.
- When the vehicle and trailer electrical systems work correctly and are not damaged.
- When the vehicle is locked using the vehicle key and the anti-theft alarm is turned on.

When the vehicle is locked, the alarm is triggered when the electrical connection between the vehicle and the trailer is removed.

Always turn off the anti-theft alarm system before connecting or disconnecting a trailer. Otherwise, the tilt sensor may erroneously activate the alarm.

Trailer with rear LED lights

For technical reasons, trailers fitted with rear LED lights cannot be connected to the anti-theft alarm system.

When the vehicle is locked, the alarm does not trigger if the electrical connection with the trailer is cut if it has rear light with light-emitting diodes.

⚠ WARNING

Erroneous or unsuitable connection of electric cables may supply energy to the trailer causing an anomaly in the vehicle electronics that could result in an accident with serious consequences.

- **All work on the electrical system must be carried out only by a specialised workshop.**

- Never connect the trailer's electric system to the electrical connections of the rear lights or any other power sources.

CAUTION




Do not leave the trailer connected to the vehicle when parked; places on its support wheel or its supports. For example, when changing the load or a puncture, the vehicle will be pushed up or down. The force acting on the tow hitch and the trailer could damage the vehicle or the trailer.

Note

- In the event of a fault in the vehicle or trailer electrical system or in the event of problems with the anti-theft alarm system, have the system checked by a specialised workshop.
- If the trailer accessories use energy from the power socket when the engine is stopped, the battery will be discharged.
- For technical reasons, trailers fitted with rear LED lights cannot be connected to the anti-theft alarm system.
- If the vehicle battery is running low, the electrical connection with the trailer is automatically cut.
- With the engine running, the electrical equipment on the trailer will be supplied with power.

Loading the trailer

Trailer weight / drawbar load

The trailer weight is the load that the vehicle can pull  . The drawbar load is the vertical weight of the tow hitch on the tow hitch ball  page 245.

The figures for trailer weights and drawbar load weights given on the data plate of the tow hitch are for values of this model only. The correct figures for your specific vehicle, which may be *lower* than these figures for the tow hitch, are given in the vehicle documentation. The instructions in the official vehicle documents take precedence.

For the sake of road safety, SEAT recommends using the maximum allowed **drawbar load**. The handling of the combined vehicle and trailer will be poor if the drawbar load is too low.

The drawbar load increases the weight on the rear axle, reducing the vehicle carrying capacity.

Gross combination weight

This figure refers to the combined weight of the loaded vehicle and loaded trailer.

Loading the trailer


The combined vehicle and trailer must be balanced. Use the maximum drawbar load

authorised and do not overload the front or the rear of the trailer:

- Distribute loads in the trailer so that heavy objects are as near to the axle as possible or above it.
- Correctly secure the trailer load.

Tyre pressure

Inflate the trailer tyres according to the manufacturer's instructions.

Inflate the towing vehicles tyres to the maximum  page 287.

WARNING

Exceeding the maximum authorised axle load, drawbar load or the gross combination weight of the towing vehicle and trailer could cause a serious accident with severe consequences.

- Never exceed the specifications.
- With the actual load on the front and rear axles, the maximum axle load should never be exceeded. The weight on the front and rear should never exceed the gross vehicle weight.

WARNING

If the load moves, the stability and safety of the vehicle and trailer combination will be seriously affected and this could result in a serious accident.

- Always correctly load the trailer.
- Always secure loads correctly with suitable and undamaged attachment rope or straps.

Driving with a trailer

Adjusting the headlights

When towing a trailer, the front of the vehicle may rise and so the dipped beam headlights may blind other drivers. Use the headlight range control to lower the cone of light. If you do not have headlight range control, have the headlights adjusted by a specialised workshop. Vehicles with high-intensity discharge lamps adapt automatically and do not require adjustment.

Things to note when towing a trailer or caravan

- If the trailer has an **overrun brake**, apply the brakes *gently at first* and then, firmly. This will prevent the jerking that can be caused by the trailer wheels locking.
- As of the combined vehicle and trailer mass, braking distances will be greater.
- Select a low gear before driving down a steep hill to use the engine braking effect to slow down the vehicle. Otherwise, the braking system could overheat and fail.
- The vehicle centre of gravity and handling change because of the trailer load and be-



cause of the increased combined mass of the vehicle and trailer.


- If the towing vehicle is empty and the trailer loaded then the load distribution is incorrect. If you must travel in these conditions, drive carefully and reduce your speed accordingly.

Hill starts with a trailer

Depending on the hill and the gross combined weight, it is possible that the combined vehicle and trailer “move backwards” slightly.

For a hill start with a trailer, proceed as follows:

- Press and hold the brake pedal.
- Press the  button once to turn off the electric parking brake **»» page 188**.
- Press and hold the  button to hold the vehicle and trailer combination using the parking brake.
- With a manual gearbox: press the clutch pedal to the floor.
- Engage first gear or the gear range **D** **»» page 193, Gearbox**.
- Release the brake pedal.
- Move off slowly. To do this, gently release the clutch pedal (for manual gearbox).

- Release the  button only when the engine provides sufficient power to move the vehicle and trailer combination.


WARNING

Jerking the trailer in an unsuitable manner could cause loss of vehicle control with the subsequent serious consequences.


- **Driving with a trailer and transporting heavy or a large objects will change the vehicle handling and braking distances.**
- **Anticipate traffic and be extremely cautious. Brake early.**
- **Adjust your speed and driving style to visibility, road, traffic and weather conditions. Reduce your speed, especially on steep hills.**
- **Accelerate gently and carefully. Avoid brusque manoeuvres and sudden braking.**
- **Always take the following precautions seriously. Reduce your speed immediately if you observe the trailer rocking from side to side.**
- **Never try to stop the “snaking” by increasing speed.**
- **Always take the speed limits for vehicles with and without trailers into account.**

Stabilising the vehicle and trailer combination

Stabilisation of the vehicle and trailer combination is an extension of the electronic stability control (ESC) and helps, with the assistance of the trajectory control, to reduce trailer “snaking”.

Stabilisation of the vehicle and trailer combination is active when the ESC  indicator on the dash panel remains lit for about two seconds more than the ABS indicator.

Requirements for stabilising the vehicle/trailer combination

- An original tow hitch is fitted by the manufacturer or a compatible model is retrofitted.
- The ESC is switched on. The  warning lamp on the dash panel is not lit.
- The trailer is connected to the vehicle using the power socket.
- It travels faster than 60 km/h (37 mph).
- The maximum drawbar load is used.
- The trailer must have a fixed drawbar.
- Trailers with brakes must be equipped with a mechanical inertia brake.

WARNING

Do not let the extra safety afforded by the stabilisation system tempt you into taking any risks when driving.

- Adjust your speed and driving style to visibility, road, traffic and weather conditions.
- If the road surface is slippery, take care when accelerating.
- When a system is operating, lift your foot off the accelerator.

WARNING

It is possible that the combination stabilisation system does not correctly recognise all driving situations.

- It is possible that the stabilisation system does not detect snaking of a light trailer and thus does not intervene.
- When driving on slippery ground, the trailer could *jack-knife* despite the stabilisation system.
- Trailers with a high centre of gravity may even tip over before they start to rock sideways.
- If a trailer is not used and the trailer power socket is connected (e.g. installation of a bicycle carrier with lights), repeated automatic braking may occur in extreme driving conditions.

Retrofitting a tow hitch

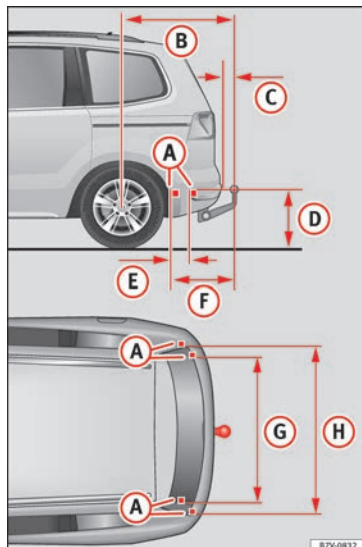


Fig. 232 Measurements and attachments to retrofit a tow hitch

SEAT recommends visiting a specialised workshop to retrofit a tow hitch. For example,

it may be necessary to adjust the cooling system or to include thermal plates. SEAT recommends taking your car in for technical service.

In any case, the separation distances must be observed when fitting a tow hitch. The distance between the centre of the tow hitch ball and the road surface » Fig. 232 **D** must never be lower than that indicated. This also applies when the vehicle is fully laden, including maximum drawbar load.

Separation distances » Fig. 232:

- A** Attachment points.
- B** 1,040 mm (41 inches)
- C** 74 mm (3 inches)
- D** 364 mm (14 inches)
- E** 247 mm (10 inches)
- F** 596 mm (23 inches)
- G** 1,097 mm (43 inches)
- H** 1,102 mm (43 inches)

WARNING

Erroneous or unsuitable connection of electric cables may cause anomalies in the vehicle electronics that could result in an accident with serious consequences.

- Never connect the trailer's electric system to the electrical connections of the rear lights or any other unsuitable power sources. Only use suitable connectors to connect a trailer.

- Visit a specialised workshop if you wish to retrofit a tow hitch to the vehicle.

WARNING

If the tow hitch is badly fitted or unsuitable, the trailer may separate from the vehicle while driving. This could result in a serious accident.

Note

Use only tow hitches approved by SEAT for the vehicle.

Maximum permitted trailer weights

The instructions in the official vehicle documents take precedence. All the technical data provided in this documentation is applicable to the basic model. The vehicle data label in the Maintenance Programme or the vehicle documentation shows which engine is installed in your vehicle.

The figures may be different depending whether additional equipment is fitted, for different models and for special vehicles.

WARNING

Exceeding the maximum trailer weight indicated could cause a serious accident.

- Never exceed the indicated trailer weight.

CAUTION

Exceeding the maximum trailer weight indicated could cause damage to the vehicle.

- Never exceed the indicated trailer weight.

Gross combined vehicle weight rating

The instructions in the official vehicle documents take precedence. All the technical data provided in this documentation is applicable to the basic model. The vehicle data label in the Maintenance Programme or the vehicle documentation shows which engine is installed in your vehicle.

The figures may be different depending whether additional equipment is fitted, for different models and for special vehicles.

The maximum combined weights listed are only applicable for altitudes up to 1000 m above sea level. The weight of the car and trailer must be reduced by about 10% for every further 1000 m (or part thereof).

WARNING

Exceeding the maximum weight indicated could cause a serious accident.

- Never exceed the gross combined weight rating.

CAUTION

Exceeding the maximum gross combined weight rating indicated could cause damage to the vehicle.

- Never exceed the gross combined weight rating.

Advice

Care and maintenance

Accessories, replacement of parts and modifications

Introduction

WARNING

The use of spare parts and accessories, or incorrectly performed modifications or repairs may result in damage to the vehicle, accidents and serious injury.

- SEAT strongly recommends you to only use SEAT approved accessories and SEAT® original spare parts. These parts and accessories have been specially tested by SEAT for suitability, reliability and safety.
- Have any repairs or modifications carried out at a specialised workshop. These workshops have the necessary tools, diagnostics equipment, repair information and qualified personnel.
- Only mount parts with the same specifications as the parts fitted at factory.
- Never mount, fasten or fit objects such as drink holders or telephone cradles over the covers of the airbag modules or within their radius of action.

- Only use wheels and tyre combinations which have been approved by SEAT for your vehicle type.

Accessories and spare parts

SEAT recommends you consult an Official Service before purchasing accessories and spare parts or consumables. For example, when fitting accessories at a later date, or when replacing a component. A technical service centre will advise you as to the legal requirements and manufacturer's recommendations regarding accessories, spare parts and other components.

SEAT recommend you use only approved **SEAT accessories** and **genuine SEAT spare parts**®. These parts and accessories have been specially tested by SEAT for suitability, reliability and safety. In addition the technical service centre will guarantee that the assembly is carried out professionally.

Although we continually monitor the market, SEAT cannot guarantee that products **not approved by SEAT** are reliable, safe and suitable for the vehicle. Therefore, SEAT cannot accept liability, even in those cases authorised by an officially recognised technical inspection office or other official body.

Any **retro-fitted equipment** which has a direct effect on the vehicle and/or the way it is driv-

en must be approved by SEAT for use in your vehicle and bear the e mark (the European Union's authorisation symbol). This includes cruise control systems or electronically controlled suspension.

If any **additional electrical devices** are fitted which do not serve to control the vehicle itself, these must bear the CE mark (European Union manufacturer conformity declaration). This includes refrigerator boxes, laptops or ventilator fans.

WARNING

Unprofessional repairs or modifications to the vehicle may affect the performance of the airbags, and may cause operating faults or fatal accidents.

- Never mount, fasten or fit objects such as drink holders or telephone cradles over the covers of the airbag modules or within their radius of action.
- Objects placed over the airbag covers, or within their radius of action, could lead to serious injury or loss of life if the airbags are triggered.

Service fluids and components

All vehicle fluids and consumables, such as notched belts, tyres, coolant fluids, engine oils, spark plugs and batteries are continually being developed. Therefore all fluids and

consumables should be changed at a specialised workshop. Technical services are permanently informed of any modifications.

WARNING

The incorrect use or handling of fluids or consumables may result in accident, serious injury, burns or intoxication.

- Therefore, fluids must always be stored closed in their original container.
- Never store fluids in empty food containers or bottles as other people may accidentally drink the fluid.
- Keep all fluids and consumables out of reach of children.
- Read and observe the information and warnings given on the fluid containers.
- Only work in the open air or in well-ventilated zones, when using products which give off harmful vapours.
- Never use fuel, turpentine, engine oil, acetone or any other volatile liquid in the maintenance of the vehicle. These are toxic and highly flammable. They could lead to fire or explosions!

CAUTION


- Only use appropriate fluids. Do not confuse fluids as this can cause serious malfunctions or engine damage.
- Accessories and other components mounted in front of the air inlet reduce the cooling

effect of the coolant. If the engine is running under great strain in high outside temperatures, it could overheat.

For the sake of the environment

Leaking fluids could pollute the environment. Collect any spilt fluids in suitable containers and dispose of them in accordance with legislation and with respect for the environment.

Technical repairs and replacements

When performing repairs and technical modifications, SEAT's directives must be observed! »» 

Unauthorised modifications to the electronic components or software in the vehicle may cause malfunctions. Due to the way the electronic components are linked together in networks, other indirect systems may be affected by the faults. This may significantly affect the vehicle's performance, increase component wear and could mean that the vehicle registration documents are no longer valid.

Your technical service centre cannot be held liable for any damage caused by technical modifications or repairs performed incorrectly.

The technical service centre does not accept liability for damage resulting from technical modifications or repairs performed incorrect-

ly; neither is the SEAT warranty valid in these cases.

SEAT recommends you have any technical modifications or repairs performed at a technical service centre and that you use **genuine SEAT spare parts®**.

Vehicles with special accessories and equipment

The manufacturers of additional equipment guarantee that the equipment complies with applicable laws and regulations with respect to the environment, in particular Directives 2000/53/CE and 2003/11/CE. The first directive governs the disposal of end-of-life vehicles while the second refers to the restrictions on the marketing and use of certain dangerous substances and preparations.

The vehicle owner should keep the documentation for the additional equipment safely and hand it over to the scrap yard at the end of the vehicle's service life. This ensures that any additional equipment mounted in end-of-life vehicles is correctly disposed of with respect for the environment.

WARNING

Repairs or modifications which are not performed correctly may result in damage or errors in the vehicle operation, affecting the effectiveness of the driver assist systems. This could result in serious accident.

- **All repairs and modifications to the vehicle should only be performed by a specialised workshop.**

Repairs and malfunctions in the airbag system

When performing repairs and technical modifications, SEAT's directives must be observed! »» ⚠

Modifications and repairs to the front bumper, doors, front seats, and repairs to the roof or chassis should only be carried out in a specialised workshop. These components may contain parts or sensors belonging to the airbag system.

If work is carried out on the airbag system or parts have to be removed and fitted on the system when performing other repair work, parts of the airbag system may be damaged. The consequence may be that, in the event of an accident, the airbag inflates incorrectly or does not inflate at all.

So that the effectiveness of the airbag is not reduced and that removed parts do not cause any injuries or environmental pollution, regulations must be observed. These requirements are known to specialised workshops.

Modifications to the vehicle suspension may affect the operation of the airbag system in the event of collision. For example, if wheel

and tyre combinations not approved by SEAT are used, or if the vehicle height is lowered, the suspension is stiffened or the suspension springs, telescopic arms, dampers, etc., are modified, the results received by the airbag sensors and sent to the control unit may not be accurate. For example, some modifications to the suspension could increase the force measured by the sensors and result in the triggering of the airbag systems in collisions. Under normal conditions, the measured values would be lower and the airbag would not have been triggered. Other modifications may reduce the forces measured by the sensors and prevent the airbags from being triggered when they should.

⚠ WARNING

Repairs or modifications which are not performed correctly may result in damage or errors in the vehicle operation, affecting the effectiveness of the airbag systems. This could result in serious or fatal accidents.

- **All repairs and modifications to the vehicle should only be performed by a specialised workshop.**
- **Airbag modules must never be repaired: if damaged, they must be replaced.**
- **Never fit recycled or reused airbag components in your vehicle.**

⚠ WARNING

Modifications to the vehicle suspension, including the use of unauthorised wheel and tyre combinations, may affect the performance of the airbags and increase the risk of serious or fatal injury in the event of accident.

- **Never fit suspension components which are not identical to the original parts in the vehicle.**
- **Never use wheel and tyre combinations not approved by SEAT.**

Retrofitting of mobile phones

An exterior aerial is required for the use of two-way radios in the vehicle.

The retro-fitting of electrical or electronic appliances in the vehicle is subject to their approval for use in your vehicle. Under certain circumstances, this could mean that your vehicle registration documents are no longer valid.

SEAT has approved your vehicle for use with two-way radios providing the following conditions are observed:

- The exterior aerial must be mounted professionally.
- The maximum transmitting power is 10 watts.



The optimal reach of the equipment is only achieved with an external aerial.

Check first with a specialised workshop that understands the technical possibilities of installation if you wish to use a two-way radio with a transmitting power of over 10 watts. SEAT recommends taking your car in for technical service.

All legal requirements, together with the instructions for the use of two-way radios must be observed.

WARNING

If the two-way radio is not securely fastened in position, it could be sent flying around the vehicle in the event of sharp braking, sudden manoeuvres or accident, causing injury.

- While driving, two-way radios must be securely fastened in position, outside the radius of action of the airbags, or safely stowed away.

WARNING

When using a two-way radio without a connection to an exterior aerial, the maximum permitted levels of electromagnetic radiation may be exceeded. This is also the case if the aerial has not been correctly installed.

- You should only use a two-way radio inside the vehicle if it has first been correctly connected to an exterior aerial.

Information stored by the control units

Your vehicle is fitted at the factory with a series of electronic control units responsible for the engine and gearbox management. In addition, the control units supervise the performance of the exhaust gas system and the airbag systems.

Therefore, while the vehicle is being driven, these electronic control units are continuously analysing the vehicle data. In the event of faults or deviations from the theoretical values, only this data is stored. Normally, the warning lamps on the instrument panel light up in the event of faults.

This data can only be read and analysed using special equipment.

The storing of the data allows specialised workshops to detect and repair faults. Stored data may include:

- Data relating to the engine or the gearbox
- Speed
- Direction of travel
- Braking force
- Detection of seat belt

The vehicle control units never record conversations held by passengers in the vehicle.

In vehicles equipped with an emergency call function via the mobile phone or other appli-

cations connected in the vehicle, it is possible to send the vehicle position. If the control unit records an accident with airbag activation, the system may automatically send a signal. This will depend on the network operator. Normally, transmission is only possible in areas with good coverage.

Event Data Recorder

The vehicle is **not** fitted with an event data recorder.

An event data recorder temporarily stores the vehicle information. Therefore, in the event of an accident, it is possible to obtain detailed information about how the accident occurred. For example, in vehicles with airbag systems, data relating to speed of impact, seat belt status, seat positions and airbag activation times may be stored. The volume of data depends on the manufacturer.

Event data recorders can only be mounted with authorisation from the vehicle owner and, in some countries, they are governed by local legislation.

Reprogramming control units

On the whole, all the data required for the component management is stored in the control units. The programming of certain convenience functions, such as the turn signals, individual door opening and instructions on the display can be modified using special

equipment at the workshop. If this is the case, the information and descriptions given in the Instruction Manual will not match the original functions. Therefore, SEAT recommends that any modifications be recorded in the section “Other workshop notes” in the Maintenance Programme.

The technical service centre must have a record of any modification to the programming.

Reading the vehicle fault memory

There is a diagnostics connector in the vehicle interior for reading the vehicle fault memory. The fault memory documents errors and deviations from the theoretical values of the electronic control units.

The diagnostics connector is in the driver side footwell area, next to the lever for opening the bonnet, below a cover.

The fault memory should only be read and reset by a specialised workshop.

Using a mobile telephone in a vehicle without connection to an exterior aerial

Mobile telephones transmit and receive radio waves, both when in use and when on standby. Scientific studies state that radio waves exceeding certain values may be harmful to the human body. International committees

and authorities have established limits and directives in order to ensure electromagnetic radiation from mobile phones remains within certain limits that do not endanger health. Nevertheless, there is no conclusive scientific evidence that wireless telephones are totally safe.

Therefore, some experts recommend that use of mobile phone be kept to a minimum until the results of current research are published.

When a mobile phone not connected to an exterior aerial is used inside the vehicle, the electromagnetic radiation may be greater than if the mobile phone were connected to a built-in aerial or to another exterior aerial.

If the vehicle is fitted with a suitable hands-free device, it will comply with the legislation in many countries which only permits the use of mobile phones inside vehicles using a hands-free device.

The hands-free system mounted at the factory has been designed for use with conventional mobile phones and phones with Bluetooth technology. Mobile phones should be placed on a suitable phone cradle. In addition, the cradle should always be correctly fitted into the base plate. This ensures that the mobile phone is securely attached to the dash panel, it is always within reach of the driver and is connected to the vehicle exterior aerial.

If the mobile phone is connected to an aerial incorporated into the vehicle or an exterior aerial connected to the vehicle, it will help reduce the electromagnetic radiation transmitted and the risk to human health. It will also improve the quality of the connection.

If the phone is used inside the vehicle without the hands-free system, it will not be securely fastened and will not be connected to the exterior aerial of the vehicle telephone. Nor will the telephone charge if it is not on the support. In addition, some calls may break off and the quality of the connection will be affected.

Mobile phones should only be used inside the vehicle if they are connected to a hands-free system with an exterior aerial.

WARNING

If the mobile phone is not securely fastened in position, it could be sent flying around the vehicle in the event of sharp braking, sudden manoeuvres or accident, causing injury.

- **While driving, mobile phones must be securely fastened in position, outside the radius of action of the airbags, or safely stowed away.**

WARNING

When using a mobile phone without a connection to an exterior aerial, the maximum permitted levels of electromagnetic radiation »

may be exceeded. This is also the case if the aerial has not been correctly installed.

- A minimum of 20 centimetres should be kept between mobile phone aerials and artificial pacemakers, as mobile telephones may affect the working of pacemakers.
- Do not keep mobile phones in breast pockets directly above pacemakers.
- Switch off the mobile phone immediately if you suspect there may be interference.

Support points for raising the vehicle

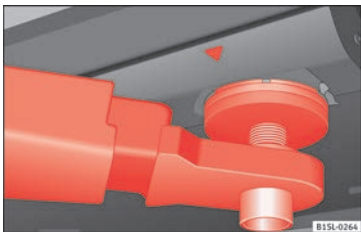


Fig. 233 Front jacking points for raising vehicle with lifting platform or jack

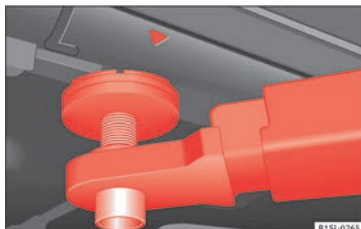



Fig. 234 Rear jacking points for raising vehicle with lifting platform or jack

Always use the jacking points indicated in the figures » **Fig. 233** and » **Fig. 234** when raising the vehicle. If the vehicle is not lifted at these points, it could be seriously damaged » **!** or lead to serious injury » **!**.

The vehicle should not be lifted using lifting platforms with lift pads containing fluid.

When raising a vehicle using a platform or jack, a series of precautionary measures are required. Do not raise the vehicle with a lifting platform or jack unless you have received training in how to do so and know how to do so safely.

Notes on raising the vehicle with a jack »  page 48.

! WARNING

The improper use of the lifting platform or the jack when raising the vehicle may result in accidents or serious injury.

- Before raising the vehicle, please observe the manufacturer's instructions for the platform or jack, and the legal requirements, where applicable.
- There should not be anyone inside the vehicle when it is being raised or once it is in the air.
- Only use the jacking points indicated in the figures » **Fig. 233** and » **Fig. 234** when raising the vehicle. If the vehicle is not lifted at the indicated points, it may fall from the platform while the engine or gearbox is being dismantled, for example.
- The jacking points should be centrally aligned and firmly positioned on the platform support plates.
- Never start the engine when the vehicle is raised! The vehicle may fall from the platform due to the engine vibrations.
- If it is necessary to work underneath the vehicle while it is raised, you should check that the supporting stands have an adequate load capacity.
- Never climb onto the lifting platform.
- Always make sure that the weight of the vehicle does not exceed the lifting platform load capacity.

ⓘ CAUTION

- Never raise the vehicle at the engine oil sump, the gearbox or the rear or front axles.
- Always use an intermediate rubber support to prevent damage to the vehicle underbody. Check that the arms of the lifting platform are able to move with obstruction.
- The arms should not come into contact with the side running boards or other parts of the vehicle.

Caring for and cleaning the vehicle exterior

Introduction

Regular maintenance and washing help to **maintain the value** of the vehicle. This may also be one of the requirements for acknowledging warranty claims in the event of bodywork corrosion or paint defects.

Products suitable for the care of your vehicle are available at any technical service.

⚠ WARNING

Car-care products may be toxic and hazardous. If car care products are not suitable or are used inappropriately, this could result in accident, serious injury, burns or intoxication.

- Car care products must always be stored in the original container which should be kept closed.
- Observe information provided by the manufacturer.
- To prevent confusion, never store car care products in empty food cans, bottles or other containers.
- Keep all care products out of reach of children.
- Harmful vapours may be produced when using car care products. Therefore, care products should only be used in well-ventilated spaces or in the open air.
- Never use fuel, turpentine, engine oil, acetone or any other volatile liquid to wash, clean or care for the vehicle. These are toxic and highly flammable.

⚠ WARNING

Inappropriate care and cleaning of vehicle components may effect the vehicle safety equipment, increasing the risk of severe injury.

- Vehicle components should only be cleaned and maintained in accordance with the manufacturer's instructions.
- Only use approved or recommended care products.

ⓘ CAUTION

Cleaning products which contain solvents will damage the material.

🌱 For the sake of the environment

- Only wash the vehicle in areas allocated for this purpose, to prevent dirty water which may be contaminated by oil, grease or fuel, from entering the drains. In some places, washing it outside the planned areas is even banned.
- Where possible, always use products which respect the environment.
- The remains of car care products should not be disposed of with ordinary household waste. Observe information provided by the manufacturer.

Washing the vehicle

The longer substances such as insects, bird droppings, resinous tree sap, road dirt, industrial deposits, tar, soot or road salt and other aggressive materials remain on the vehicle, the more damage they do to the paintwork. High temperatures (for instance due to strong sunlight) further intensify the corrosive effect. The vehicle **undercarriage** should also be thoroughly washed at regular intervals.



Automatic car washes

Always observe the instructions provided at the automatic car wash. The standard precautionary measures prior to entering the car wash should be taken to avoid damage to the vehicle (close all windows and the roof, fold in exterior mirrors). If the vehicle is fitted with additional components (spoiler, roof-rack, aerial, etc.), check with the car wash supervisor whether these can enter the car wash » ❶.

The vehicle paintwork is so durable that the vehicle can normally be washed without problems in an automatic car wash tunnel. However, wear and damage to the paintwork will depend on the type of car wash used. SEAT recommends the use of car washes without brushes.

To remove traces of wax on windows and to prevent wiper blades from scratching, please observe the following » page 255, Cleaning windows and exterior mirrors.

Washing the car by hand

When washing the car by hand, use plenty of water to soften the dirt first, and rinse off as well as possible.

Then clean the vehicle with a soft **sponge, glove** or **brush** using only slight pressure. Start at the roof and work downwards. Special **car shampoo** should only be used for very persistent dirt.

Rinse the sponge or glove thoroughly and often.

Wheels, sills and similar should be cleaned last. Use a second sponge for this.

⚠ WARNING

Sharp components on the vehicle may cause injury.

- Protect arms and hands from sharp edges when cleaning the vehicle undercarriage or the interior of the wheel hubs.

⚠ WARNING

After the vehicle has been washed, the braking effect will be reduced (and the braking distance increased) due to moisture (and ice in winter) on the brakes.

- “Dry the brakes and remove ice” by braking carefully. Ensure that you are not endangering other road-users or breaking traffic regulations in the process.

⚠ CAUTION

- The temperature of the water must not exceed +60°C (+140°F).
- To avoid damage to the paintwork, do not wash the vehicle in full sun.
- Do not use rough sponges or similar which could damage the surface to clean away the traces of insects.

- Never wipe the headlights with a dry cloth or sponge, always moisten first. It is best to use soapy water.

- Washing the vehicle in low temperatures: When washing the vehicle with a hose, do not direct water into the lock cylinders or the gaps around the doors or roof. Locks and seals could freeze!

⚠ CAUTION

To avoid any risk of damage to the vehicle, please check the following points before using an automatic car wash:

- Compare the distance between the vehicle wheels and the distance between the guide-rails of the car wash to prevent damage to the wheels and tyres!
- Switch off the rain sensor and the Auto Hold function before entering a car wash.
- Compare the height and width of your vehicle with the available height and width when entering and driving through the car wash.
- Fold in exterior mirrors Electrically retractable exterior mirrors must not be folded in or out by hand. Always use the electrical power control.
- To avoid damaging the bonnet paintwork, rest the wipers on the windscreen after drying them. Do not let them fall!
- Lock the rear lid to prevent it from opening unexpectedly while inside the car wash.

Washing the vehicle with a high pressure cleaner

When cleaning the vehicle with a high-pressure cleaner, always follow the operating instructions for the equipment. Pay special attention to the required **pressure** of the jet and the **distance** between the jet and the vehicle »» ⚠.

Keep a suitable distance from soft materials, such as rubber hoses or insulating material, and from the parking distance warning system sensors. The parking distance sensors are fitted in the rear bumpers and, where applicable, in the front bumpers »» ⓘ.

Do not use a nozzle that sprays the water out in a **direct stream** or one that has a **rotating jet** for forcing off dirt »» ⚠.

⚠ WARNING

The incorrect use of high pressure cleaning equipment could result in permanent damage, visible or invisible, to the tyres or other materials. This could result in a serious accident.

- Ensure there is a suitable distance between the nozzle and the tyres.
- Never wash tyres with a concentrated jet or so-called "dirt blasters". Even at large spraying distances and short cleaning times, you may damage the tyres.

⚠ WARNING

After the vehicle has been washed, the **braking effect will be reduced (and the braking distance increased)** due to moisture (and ice in winter) on the brakes.

- "Dry the brakes and remove ice" by braking carefully. Ensure that you are not endangering other road-users or breaking traffic regulations in the process.

ⓘ CAUTION

- The water temperature should not exceed +60°C (+140°F).
- To avoid damage to the paintwork, do not wash the vehicle in full sun.
- The sensors on the bumpers should be kept clean and free of ice at all times to ensure the parking distance warning system and the park assist system operate correctly. When cleaning with pressure hoses and steam cleaners, the sensors should be sprayed only briefly. A distance of 10 cm between the sensors and the steam / hose nozzle must be observed.
- Do not use a high pressure cleaner to remove ice or snow from windows
- Washing the vehicle in low temperatures: When washing the vehicle with a hose, do not direct water into the lock cylinders or the gaps around the doors or roof. Locks and seals could freeze!

Factory-fitted adhesive sheets

The following indications should be taken into account to avoid damaging adhesive sheets:

- Do not use high pressure cleaners.
- Do not use scrapers to remove ice or snow from the sheets.
- Do not polish the adhesive sheets.
- Do not use dirty cloths or sponges.
- It is preferable to wash them with a soft sponge and gentle neutral soap.

Cleaning windows and exterior mirrors

Cleaning windows and exterior mirrors

Spray windows and exterior windows with a standard window cleaner containing alcohol.

Dry the windows with a clean chamois leather or a lint-free cloth. The chamois leathers used on painted surfaces are not suitable for cleaning windows because they are soiled with wax deposits which could smear the windows.

Use window cleaner or a silicone remover to clean rubber, oil, grease and silicone deposits off »» ⓘ.

Removing wax residue

Automatic car washes and certain car care products may leave **wax deposits** on the windows. These deposits can only be removed with a special product or cleaning cloths. Wax deposits on the windscreen could cause the wiper blades to judder. SEAT recommends you wipe the wax deposits off the windscreen with a soft cloth each time after you have washed the vehicle.

A window cleaning detergent which helps to dissolve the wax may be added to the windscreen washer fluid to prevent the wiper blades from scratching the windscreen. Please ensure you add the cleaning product in the correct proportions. Products for removing grease do not eliminate the wax deposits »» ⓘ.

Special cleaning products or window cloths are available at any technical service. To remove wax deposits, SEAT recommends the following products:

- For the hottest time of the year: the G 052 184 A1 window cleaner for summer use. Proportion 1:100 (1 part detergent, 100 parts water) in the windscreen washer reservoir.
- All year round: the window cleaner G 052 164 A2; proportion 1:2 in windscreen washer reservoir (1 part concentrate, 2 parts water) in winter, down to -18°C (-0.4°F), or 1:4, during the rest of the year.

- Window cloths G 052 522 A1 for all windows and exterior mirrors.

Removing snow

Use a small brush to remove snow from the windows and exterior mirrors.

Removing ice

If possible, use a de-icing spray to remove ice. If you use an ice scraper, push it in one direction only **without** swinging it. If you pull the scraper backwards, the dirt may scratch the window.

WARNING

Dirty or misted windows reduce visibility in all directions and increase the risk of accident and serious injury.

- **Do not drive unless you have good visibility through all windows!**
- **Remove ice and snow from the windows and demist inside and out.**

CAUTION

- **Never mix our cleaning products with other products not recommended by SEAT in the windscreen washer reservoir. This could lead to flocculation and may block the windscreen washer jets.**
- **Do not use hot or warm water to remove ice or snow from the windows and exterior mirrors. The glass could crack!**

- **The heating element for the rear window is located on the inner side of the window. Do not stick adhesive labels over the heating elements and never clean the inside of the rear window with corrosive or acid products or other similar chemical cleaning products.**
- **Aerials on the inside of windows may be damaged if knocked or if cleaned with corrosive or acid cleaning products. Do not stick adhesive labels over the heating elements and never clean the inside of the rear window with corrosive or acid products or other similar chemical cleaning products.**

Caring for and polishing the vehicle paintwork

Waxing

Regular waxing protects the paintwork. It is time to apply a good coat of wax when water no longer **forms droplets** and rolls off the clean paintwork.

Even if a **wax solution** is used regularly in the automatic car wash, SEAT recommends protecting the paint with a hard wax coating at least twice a year.

Polishing

Polishing is only necessary if the paint has lost its shine, and the gloss cannot be brought back by applying wax.

If the polish does not contain wax, a wax product should be applied after polishing.

ⓘ CAUTION

- To prevent damage, car polish or hard wax should not be used on components painted in matt paint, plastic components and the glass headlamp and tail light covers.
- Do not polish the paintwork if it is dirty, apply polish in dusty or sandy zones.

Cleaning chrome parts

Clean chrome parts with a damp cloth. SEAT recommends the use of a chrome care product to clean stains and dirt from chrome surfaces. Use a soft dry cloth to polish chrome parts.

ⓘ CAUTION

To prevent scratching chrome surfaces:

- Do not use abrasive products.
- Do not clean or polish chrome parts in a sandy or dusty environment.
- Do not polish dirty surfaces.

Caring for and cleaning anodized surfaces

It is not easy to detect the difference between aluminium and an anodized surface, for example, a radiator grille. However, anodized surfaces must not be treated in the same way as aluminium surfaces. Never use rough sponges or cloths to wipe away insect remains.

- Use a clean, damp, lint-free cloth to clean anodized surfaces.
- If there is a lot of dirt, use a special cleaning product which does not contain **solvents**.

ⓘ CAUTION

To prevent damage to the anodized surfaces:

- Do not use products containing solvents.
- Do not use polish or hard wax.
- Do not use abrasive products.
- Do not polish anodized surfaces in sandy or dusty environments.
- Do not polish dirty surfaces.

Cleaning wheels

Cleaning steel wheels

Use an industrial cleaner to remove brake dust. Therefore, clean wheels regularly with a separate sponge.

Any damage to the paint on steel wheels should be touched up before the metal starts to rust.

Caring for and cleaning alloy wheels

Remove road salt and brake dust by washing the wheels approximately **once a fortnight**. Use an acid free detergent to clean the wheel rims. SEAT recommends treating the wheels thoroughly with a **wax compound** about once every three months.

It is important to remove road salt and brake dust by washing the wheels at regular intervals, otherwise the finish will be impaired.

Always use an acid-free detergent for alloy wheel rims. Car polish or other abrasive agents should not be used for maintaining the rims.

If the protective coating on the paint has been damaged (e.g. hit by a stone), it should be repaired immediately.

Caring for rubber seals

The rubber seals on doors, windows, etc., remain flexible, provide a better seal and last longer if they are regularly treated with a product specifically designed for use on rubber. »

Before applying the product, use a soft cloth to remove dust and dirt from the rubber seals.

De-icing the door lock cylinder

To de-ice the lock cylinders, SEAT recommend the use of genuine SEAT spray with lubricating and anti-corrosive properties.

ⓘ CAUTION

The use of products containing degreasing agents to de-ice the locks may rust the lock cylinder.

Protection of vehicle undercarriage

The vehicle underbody is coated to protect it from chemical and mechanical damage. The protective coat on the undercarriage may wear from use while driving. Therefore, SEAT recommends that the protective coating on the undercarriage and on the running gear should be regularly checked, and repaired if necessary.

⚠ WARNING

Additional underseal or anti-corrosion products could catch fire due to the high temperatures reached by the exhaust gas system and other engine components.

• Do not apply additional underseal or anti-corrosion products to the exhaust pipes, catalytic converters, heat shields or other parts of the vehicle which reach high temperatures.

Cleaning the engine compartment

The engine compartment of any motor vehicle is a potentially hazardous area
» page 271.

The engine compartment should only be cleaned by qualified personnel. If it is not correctly cleaned, the anti-corrosion coating and consequently electrical components may be damaged. Moreover, water may filter directly into the vehicle interior through the water chamber» ⓘ.

If the engine compartment is very dirty, always take the vehicle to a specialised workshop for professional cleaning. SEAT recommends taking your car in for technical service.

Water box

The water box is in the engine compartment, between the windscreen and the engine, and beneath a perforated cover. Air is taken in through the water box from outside to the vehicle interior via the heating and air conditioner.

Leaves and other loose objects should be regularly cleaned away from the water box either by hand or with a vacuum.

⚠ WARNING

When working on the engine or in the engine compartment, there is a risk of injury, burns, accident or fire.

- Before starting work, please ensure you are familiar with the required procedure and the safety precautions » page 271.
- SEAT recommends getting a specialised workshop to do these jobs.

ⓘ CAUTION

If water is manually poured into the water box (e.g. using a high pressure cleaning appliance), this could cause significant damage to the vehicle.

🌿 For the sake of the environment

Only wash the engine compartment in areas allocated for this purpose, to prevent dirty water which may be contaminated by oil, grease or fuel, from entering the drains. In some places, washing this compartment outside the planned areas is even banned.

Caring for and cleaning the vehicle interior

Introduction

The dye used in many modern garments, for example dark jeans, is not always sufficiently colour-fast. Seat upholstery (material and leather), especially when light-coloured, may visibly discolour if the dye comes out of clothing (even when used correctly). This is not an upholstery defect but indicates that the dye in the item of clothing is not sufficiently colour-fast.

The longer stains or dirt remain on the vehicle surfaces, especially the fabrics covering the padded upholstery, the more difficult it becomes to clean and maintain them. If stains and dirt are left for a long time, it may be that they are impossible to remove.

WARNING

Car-care products may be toxic and hazardous. Using unsuitable car-care products or, using them in the wrong way, may cause accidents, serious injury, burns or intoxication.

- Keep your car-care products in their original containers.
- Read the instructions.
- Never keep car-care products in empty food containers, bottles or other similar containers. Other people may confuse them.

- Keep all car-care products out of the reach of children.
- Some products may give off harmful vapours during use. Therefore, they should be used outdoors in well-ventilated places.
- Never use fuel, turpentine, engine oil, nail varnish remover or any other volatile product for washing, maintenance or cleaning. These are toxic and highly flammable.

WARNING


Unsuitable maintenance and cleaning of vehicle components may impair proper operation of safety equipment and cause serious injury.

- Maintain and clean vehicle components according to the manufacturer's instructions.
- Only use approved or recommended cleaning products.

CAUTION

- Cleaning products which contain solvents have a corrosive effect and may damage the material irreparably.
- Stains and dirt containing aggressive substances or solvents attack the material and may damage it irreparably, even when they are cleaned quickly.
- Dirt and stains should not be allowed to dry and should be cleaned as quickly as possible.
- In the case of stubborn stains, take the vehicle to a specialised workshop to avoid damage.

How to care for the upholstery

To treat and maintain your seat upholstery, keep the following in mind :

- Before entering the vehicle, close any Velcro fasteners that might snag on the upholstery or trim fabric. Any open Velcro fasteners may damage the trim or upholstery fabrics.
- To prevent damage, avoid direct contact between sharp decorative objects and the upholstery and trim fabrics. Decorative objects include zips, rivets and rhinestones on clothing and belts.
- From time to time, clean the dust that gathers in the perforations, folds and seams so that the surfaces of the seats are not damaged by its abrasive effect.
- Make sure clothes are colour-fast to avoid them running and staining the upholstery. This is especially important if the upholstery is light in colour.

CAUTION

If you ignore this advice, which is important for maintaining your seat upholstery, the fabric may be damaged or stained.

Note

SEAT recommends you take the vehicle to a specialised workshop to treat any stains on the upholstery caused by the discolouration of clothing.

Cleaning the trim and seat fabrics, the Alcantara®

Cleaning the upholstery on heated seats and electrically operated seats or seats with airbag components

It is possible that there are important airbag components and electrical connections inside the driver seat, passenger seat and possibly the outer rear seats. If these seats and seat backrests are damaged, or are cleaned and are treated incorrectly, or if they get wet, the vehicle electric system may be destroyed and the airbag system damaged » » » ⚠.

Electric and heated seats contain components and electrical connections that may be damaged if the seats are cleaned or incorrectly treated » » » ⚠. Similarly, damage might be caused at other points in the vehicle's electric system.

For this reason, bear the following indications in mind for cleaning:

- Do not use high-pressure or steam cleaning equipment or cold aerosols.
- Do not use cream detergents or detergent-based solutions for delicate garments.
- Prevent the fabric from getting wet at all times.
- Only use cleaning products approved by SEAT.

- If in doubt, take the vehicle to a professional cleaning company.

Cleaning the upholstery on non-heated seats and non-electrically operated seats or seats without airbag components

- Before using any cleaning products, consult and keep in mind the instructions of use, indications and warnings on the container.
- Use a vacuum cleaner (with the brush attachment) on the trim and seat fabrics, the Alcantara® upholstery of the seats and the carpet.
- Do not use high-pressure or steam cleaning equipment or cold aerosols.
- For general cleaning, use a soft sponge or an ordinary lint-free microfibre cloth » » » ⚠.
- Clean Alcantara® surfaces with a slightly damp cotton or woollen cloth, or a standard lint-free microfibre cloth » » » ⚠.

If the dirt on the trim and upholstery fabrics is only superficial, you can use a standard foam cleaner.

If the upholstery and trim are very dirty, before cleaning them we recommend you find out about the most suitable cleaning options from a professional cleaning company. If necessary, the cleaning should be carried out by a specialised company.

Stain removal

When removing stains, it may be necessary to clean the whole surface and not just the stain itself. Especially if the surface has been dirtied through normal use. If you only clean the stained area, that part may then look lighter than the rest. If in doubt, take the vehicle to a professional cleaning company.

⚠ WARNING

If there is a fault in the airbag system, it is likely that the airbag will not deploy correctly, not deploy at all, or do so unexpectedly, which could cause serious or fatal injuries.

- Have the system checked immediately by a specialised workshop.

⚠ CAUTION

If the upholstery on electrically operated seats or seats with airbag components gets soaked, the vehicle's electric system and certain other components may be damaged.

- If the seat gets soaked, take the vehicle immediately to a specialised workshop to be dried and for the system components to be inspected.
- Do not use steam cleaning equipment as the dirt becomes more encrusted and fixed in the material.
- High-pressure cleaning equipment and cold aerosols may damage the upholstery.

ⓘ CAUTION

- **Brushes should only be used to clean the carpet and floor mats! Other fabrics may be damaged if cleaned with a brush.**
- **If cream detergents or detergents for delicate garments are applied with a damp cloth or sponge, they may, for example, leave rings when dry because of the surfactant components they contain. Generally, such rings are very difficult or almost impossible to remove.**

ⓘ CAUTION

- **Do not let water soak into Alcantara® under any circumstances.**
- **Do not use leather cleaning products, solvents, wax polish, shoe cream, stain removers or similar products on Alcantara®.**
- **Never use brushes for cleaning damp material as they could damage the surface.**

Cleaning and maintenance of natural leather upholstery

Consult a professional cleaning workshop if you have any doubts on cleaning and maintaining the leather equipment in your vehicle.

Maintenance and treatment

Nappa natural leather is delicate because it has no additional protective layer.

- After cleaning, regularly apply a conditioner with sun-screen and impregnating action. These products nourish the leather, soften it and make it more breathable, as well as re-hydrating it. They also provide it with a protective film.
- Clean the leather every 2 or 3 months and remove stains as they appear.
- Treat the leather every 6 months with a suitable maintenance product.
- Apply as few cleaning and maintenance products as possible, always using a dry, lint-free cotton or woollen cloth. Do not apply cleaning and maintenance products directly to the leather.
- Remove recent ball-point pen and ink stains, lipstick, shoe cream and similar stains as soon as possible.
- Maintain the colour of the leather. To do this, use a special cream especially coloured for leather to achieve the same overall colour, if necessary.
- Afterwards, go over it with a soft cloth.

Cleaning the vehicle

SEAT recommends using a slightly damp cotton or woollen cloth for general cleaning purposes.

Generally, the leather should never be soaked at any point, nor should water penetrate the seams.

Before cleaning the leather upholstery, bear in mind the following recommendations
»» page 260, Cleaning the upholstery on heated seats and electrically operated seats or seats with airbag components.

ⓘ CAUTION

- **On no account use solvents, wax polish, shoe cream, stain removers or similar materials on leather.**
- **If the stain remains on the leather for long, it will soak in and be impossible to remove.**
- **In the event of spilt liquids, dry immediately with an absorbent cloth to prevent the liquid penetrating through the leather or seams.**
- **If the vehicle is left standing in the sun for long periods, the leather should be protected against direct sunlight to prevent it from fading.**

i Note

The leather will usually change colour slightly with use.

Cleaning synthetic leather upholstery

Before cleaning synthetic leather upholstery, bear in mind the following recommendations
»» page 260, Cleaning the upholstery on heated seats and electrically operated seats or seats with airbag components **»»**

Only use water and neutral cleaning products to clean synthetic leather upholstery.

ⓘ CAUTION

Do not use solvents, floor wax, shoe cream, stain removers or similar products on synthetic leather. These will stiffen the material, causing it to crack prematurely.

Cleaning storage compartments, drinks holders and ashtrays

Cleaning storage compartments and drinks holders

Some storage compartments and drinks holders have a removable rubber mat.

- Use a clean, damp, lint-free cloth to clean parts.
- If this does not provide satisfactory results, we recommend using a special **solvent-free** plastic cleaning product.

Cleaning the ashtray

- Extract the ashtray and empty it.
- Clean the ashtray with a dishcloth.

Use a toothpick or similar to remove ash from the area where cigarettes are stubbed out.

Care and cleaning of plastic parts, wooden trim and the instrument panel

- Use a clean, damp, lint-free cloth to clean parts.
- *Clean plastic parts (inside and outside the vehicle) and the dash panel with a special solvent-free product for the care and cleaning of plastic, approved by SEAT* » » ⚠.
- Wash *wooden trims* with a mild soap and water solution.

⚠ WARNING

Solvents cause the surfaces of the airbag modules to become porous. If an airbag is accidentally triggered, the detachment of plastic parts could cause serious injury.

- **Never clean the dash panel and the surfaces of the airbag modules with cleaners containing solvents.**

Cleaning seatbelts

If the seat belt is very dirty, the belt retractor may not work correctly thus preventing the seat belt from operating correctly.

The seat belts should never be removed from the vehicle for cleaning.

- Use a soft brush to remove the worst dirt » » ⚠.

- Pull the seat belt right out and leave it out.
- Clean dirty seat belts with a *gentle* soap and water solution.
- Wait until they are completely dry.
- Only allow the seat belt to retract when it is completely dry.

⚠ WARNING

Check the condition of all the seat belts at regular intervals. If the webbing or other parts of the belt are damaged, the vehicle should be taken to a specialised workshop immediately and the belts should be replaced. It is extremely dangerous to drive using damaged seat belts and could result in serious injury or loss of life.

- **Seat belts and their components must never be cleaned with chemical products, nor should they be allowed to come into contact with corrosive liquids, solvents or sharp objects. This could affect the strength of the seat belt webbing.**
- **Seat belts should be completely dry before retracting. Damp could damage the belt retractor so that it does not operate correctly.**
- **Do not allow liquids or foreign bodies to enter the buckle fastenings. This could damage the buckles and seat belts.**
- **Never attempt to repair, modify or remove a seat belt yourself.**
- **Always have damaged seatbelts replaced immediately by seat belts approved for the**

vehicle in question by SEAT. Seat belts which have been worn in an accident and stretched must be replaced by a specialised workshop. Renewal may be necessary even if there is no apparent damage. The belt anchorage should also be checked.

Notes for the user

Labels and plates

Some parts in the engine compartment come from the factory with certificates of safety, labels or plates containing important information regarding the operation of the vehicle, for example, on the fuel tank flap, on the passenger's sun visor, on the driver door strut, or on the floor of the boot.

- Never remove these certificates of safety, labels or plates, and ensure they are kept in good condition and are legible.
- If a vehicle part, bearing a certificate of safety, label or plate, is replaced, the specialised workshop should attach the information back in the same place.

Certificate of safety

A certificate of safety on the door strut states that all the safety standards and regulations established by the national traffic authorities responsible for road safety were met at the

time of manufacture. It may also give the month and year of manufacture, together with the chassis number.

Warning of high voltage label*

There is a label close to the bonnet lock which warns of high voltage in the vehicle's electrical system. The vehicle ignition system complies with several standards, including the Canadian standard, ICES-002.

Using your vehicle in other countries and continents

The vehicle is manufactured at the factory for use in a particular country in accordance with the national legislation in force at the time of manufacture.

If the vehicle is sold in another country or used in another country for an extended period of time, the applicable legislation of that country should be observed.

It may be necessary to fit or remove certain pieces of equipment or to deactivate certain functions. Service work may also be affected. This is particularly true if the vehicle is used in a different climate for an extended period of time.

As there are different types of frequency bands around the world, you may find that

the radio or navigation system supplied at the factory does not work in another country.

ⓘ CAUTION

- SEAT does not accept liability for any damage to the vehicle due to the use of a lower quality fuel, an inadequate service or the non-availability of genuine spare parts.
- SEAT does not accept liability if the vehicle does not comply in part or in full with the legal requirements of other countries or continents.

Radio and antenna reception

The aerial of radio and navigation systems fitted at the factory may be mounted in different parts of the vehicle:

- On the inside of the rear window, next to the rear window heating,
- on the inside of the rear side windows,
- on the inside of the windscreen,
- on the roof of the vehicle.

Aerials mounted on the inside of a window can be recognised by the fine wires.

ⓘ CAUTION

Aerials on the inside of windows may be damaged if knocked or if cleaned with corrosive or acid cleaning products. Do not stick adhesive »

labels over the heating elements and never clean the inside of the rear window with corrosive or acid products or other similar chemical products.

 Note

If electrical equipment is used near an aerial built-into the window, you may observe interference in the reception of AM stations.

Notes on SEAT repairs

 **WARNING**

Repairs or modifications which are not performed correctly may result in damage or errors in the vehicle operation, affecting the effectiveness of the driver assist and airbag systems. This could result in serious accident.

- Have any repairs or modifications carried out at a specialised workshop.

Collection and scrapping of end-of-life vehicles

Collection of end-of-life vehicles

An extensive network of used car reception centres already exists in much of Europe. After the vehicle has been delivered, you will receive a certificate of destruction describing

the environmentally friendly scrapping of the vehicle in accordance with applicable legislation.

We will collect the used vehicle free of charge, provided it complies with all national legislation.

Please see your technical service for further information about the collection and scrapping of end-of-life vehicles.

Scrapping

The relevant safety requirements must be observed when the vehicle or components of the airbag or belt tensioner systems are scrapped. These requirements are known to specialised workshops.

Checking and refilling levels

Filling the tank

Introduction

The fuel tank flap is on the rear right of the vehicle.

 **WARNING**

Refuelling or handling fuel carelessly can cause an explosion or fire resulting in serious burns and injuries.

- Always make sure that you correctly close the fuel cap to avoid evaporation and fuel spillage.
- Fuels are highly explosive and inflammable substances that can cause serious burns and injuries.
- Fuel could leak out or be spilt if the engine is not switched off or if the filler fuel nozzle is not fully inserted into the tank filler neck when refuelling. This could lead to a fire, explosion and severe injuries.
- When refuelling, turn off the engine, the auxiliary heating (»» page 180) and turn off the ignition for safety reasons.
- Always turn off mobile telephones, radio apparatus and other radio wave emitting equipment before refuelling. Electromagnetic waves could cause sparks and lead to a fire.

- Never enter the vehicle while refuelling. If it is absolutely necessary to enter, close the door and touch a metal surface before touching the filler nozzle again. This will prevent the generation of static electricity. Sparks could cause a fire when refuelling.
- Never handle fuel close to flames, sparks or objects with slow combustion (e.g. cigarettes).
- Avoid static electricity and electro-magnetic radiation when refuelling.
- Observe the safety regulations of the service station.
- Never spill fuel on the vehicle or in the luggage compartment.

WARNING

For safety reasons, SEAT does not recommend carrying a spare fuel canister in the vehicle. Fuel could be spilled and catch fire, above all in case of an accident and this applies to a full container as well as empty containers. This could lead to explosions, fires and injuries.

- Observe the following if you exceptionally have to carry fuel in a canister:
 - Never place a fuel container to fill it inside the vehicle or on the vehicle, for example, in the boot or on the hatch. Filling in these circumstances could create an electrostatic charge and spark that could ignite fuel fumes.

- Always place the canister on the ground to fill it.
- Insert the fuel nozzle into the neck of the canister as far as possible.
- If you are using a metal fuel canister, the nozzle must always touch the canister while it is being filled to avoid static electricity.
- Follow the legal requirements for the use, storage and transport of spare fuel canisters.
- Insure that the fuel container complies with manufacturing standards, for example, ANSI or ASTM F852-86.

CAUTION

- Always remove any fuel spilled on the vehicle paintwork immediately to avoid damage to the wheel housing, the tyre and vehicle paintwork.
- Refuelling a petrol engine with diesel or a diesel engine with petrol can cause serious engine and fuel system damage; the resulting malfunctions are not covered by the SEAT warranty. If you refuel with the wrong type of fuel, never start the engine. This applies to even the smallest amount of the wrong fuel. Seek specialist assistance. With the engine running, the composition of the wrong fuel could significantly damage the fuel system and the engine itself.
- In vehicles with a diesel engine, under no circumstances should you refuel or drive with

petrol, kerosene, heating oil or any other type of different fuel. Other types of fuels could cause serious damage to the engine and to the fuel supply system and the resulting problems are not covered by the SEAT warranty.

For the sake of the environment

Fuels can contaminate the environment. Collect any spilt service fluids and allow a professional to dispose of them.

Note

There is no emergency mechanism for the manual release of the fuel tank flap. If necessary, request assistance from specialised personnel.

Control lamps and fuel gauge



Fig. 235 On the instrument panel: Fuel gauge for petrol and diesel



Lights up.
Position of the gauge in the red (arrow) » **Fig. 235**

The fuel tank is almost empty » **⚠**. The fuel reserve is being used » page 40.

Refuel as soon as possible » **⚠**.



It lights up

Fuel tank not closed correctly.

Stop the vehicle and close the tank flap properly.

Several warning and control lamps light up for a few seconds when the ignition is switched on, signalling that the function is being verified. They will switch off after a few seconds.

When the or control lamp lights up, the auxiliary heater running and the supplementary heater automatically switch off.

⚠ WARNING

Driving with insufficient fuel reserve could result in the vehicle breaking down in traffic and a serious accident.

- If the fuel level is too low then the fuel supply to the engine can become irregular especially on slopes.
- If the engine “is choked” or stalls due to lack of or irregularity of the fuel supply, the power steering as well as all of the driver assistance systems including braking assistance will stop working.
- Always refuel when there is only one quarter of the fuel tank left to avoid running out of fuel.

⚠ CAUTION

- Always pay attention to any lit control lamps and to the corresponding descriptions and instructions to avoid damage to the vehicle.
- Never run the fuel tank completely dry. An irregular fuel supply may lead to ignition faults and unburnt fuel could enter the exhaust system. This could damage the catalytic converter filter or the diesel particulate filter!

i Note

The arrow next to the fuel pump symbol on the instrument panel » **Fig. 235** indicates the side of the vehicle on which the fuel tank flap is located.

Refuelling

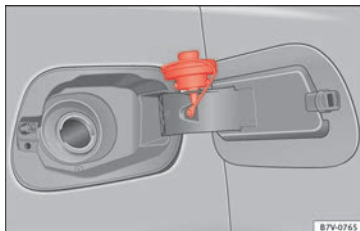


Fig. 236 Open fuel tank flap with tank cap in the holder

Read the additional information carefully » page 40

Refuelling

The correct petrol type for the vehicle is located on a sticker inside the fuel tank flap » page 267.

- If the automatic filler nozzle is operated correctly, it will switch itself off as soon as the tank is *full* » **⚠**.

• Do not continue to refuel if it is turned off! Otherwise, this will fill the expansion chamber and fuel may leak out if the ambient conditions are warm.

WARNING

Do not continue refilling once the fuel nozzle has switched itself off. The fuel tank may be filled too much. As a result, fuel may spurt out and spill. This could lead to a fire, explosion and severe injuries.

CAUTION

• **Always remove any fuel spilled on the vehicle paintwork immediately to avoid damage to the wheel housing, the tyre and vehicle paintwork.**

For the sake of the environment

Spilt fuel can contaminate the environment.

Fuel

Types of petrol

The correct grade of petrol is listed inside the fuel tank flap.

The vehicle is equipped with a catalytic converter and must only be run on **unleaded petrol**. The petrol must comply with European Standard EN 228 or German standard DIN

51626-1 and must be **unleaded**. You can refuel with a maximum ethanol proportion of 10 % (E10). The types of petrol are differentiated by their **octane rating (RON)**.

The following titles appear on the corresponding adhesive on the fuel tank flap:

Super unleaded 95 octane or normal 91 octane unleaded petrol

We recommend you use super 95 octane petrol. If this is not available: normal 91 octane petrol, with a slight decrease in power.

Super unleaded petrol with a minimum of 95 octanes

You should use super petrol with a minimum of 95 octanes.

If super is not available, *in an emergency* you may refuel with normal 91 octane petrol. In this case only use moderate engine speeds and a light throttle. Refuel with super as soon as possible.

Super unleaded 98 octane or super 95 octane unleaded petrol


We recommend you use super plus 98 octane petrol. If this is not available: super 95 octane petrol, with a slight decrease in power.


If super is not available, *in an emergency* you may refuel with normal 91 octane petrol. In this case only use moderate engine speeds

and a light throttle. Refuel with super as soon as possible.

Petrol additives

The quality of the fuel influences the behaviour, power and service life of the engine. This is why the petrol you use should carry suitable additives already included by the petrol industry, free of metals. These additives will help to prevent corrosion, keep the fuel system clean and prevent deposits from building up in the engine.

If good-quality petrol with metal-free additives is not available or engine problems arise, the necessary additives must be added when refuelling **»** .

Not all petrol additives have been shown to be effective. The use of unsuitable petrol additives may cause significant damage to the engine and the catalytic converter. Metal additives should never be used. Metal additives may also be contained in petrol additives for improving anti-detonation ratings or octane ratings **»** .

SEAT recommends “genuine Volkswagen Group Fuel Additives for petrol engines”. These additives can be bought at SEAT dealers, where information on how to use them can also be obtained.

ⓘ CAUTION

- Do not refuel if the filler indicates that the fuel contains metal. LRP (*lead replacement petrol*) fuels contain high concentrations of metal additives. Using them may damage the engine!
- Never refuel with fuels containing a large proportion of ethanol (for example, E50, E85). This could damage the fuel system.
- Just filling one full tank of leaded fuel or fuel containing other metal additives would seriously impair the efficiency of the catalytic converter.
- Only use fuel additives that have been approved by SEAT. Octane boosting or anti-knock additives may contain metal additives that could seriously damage the engine or the catalytic converter. These additives must not be used.
- High engine speed and full throttle can damage the engine when using petrol with an octane rating lower than the correct grade for the engine.

📘 Note

- You may use petrol with a high octane number than the one recommended for your engine.
- In those countries where unleaded petrol is not available, you may refuel with a fuel with a low lead content.

Diesel fuel

Please note the information on the inside of the fuel tank flap.

We recommend the use of **diesel** fuel which complies to European standard EN 590. If diesel fuel which meets European standard EN 590 is not available, the Cetane number (CZ) must, at minimum, be 51. If the engine is equipped with a particulate filter, the sulphur content of the fuel must be below 50 parts per million.

Winter-grade diesel

Summer fuel becomes thicker in winter and it is more difficult to start the engine. For this reason, petrol stations in some countries also offer winter diesel with improved fluidity when cold (winter-grade diesel).

ⓘ CAUTION

- The vehicle is not designed for the use of FAME fuel (biodiesel). The fuel system would be damaged if you used biodiesel.
- Do not mix fuel additives, the so-called “thinners”, petrol or similar additives with diesel fuel.
- If poor-quality diesel fuel is used, it may be necessary to drain the fuel filter more frequently than is specified in the Maintenance Programme. We recommend having this done by a specialised workshop. If water is allowed

to collect in the filter, this can cause engine performance problems.

Selective catalytic reduction* (AdBlue)**Introduction**

In vehicles with “Selective Catalytic Reduction”, a special urea solution (AdBlue) is injected into the exhaust gas system in front of the catalytic converter to reduce nitrogen oxide emissions.

The consumption of AdBlue depends on individual driving style, the temperature at which the system operates and the outside temperature where the vehicle is driven.

AdBlue is kept in an independent tank in the vehicle and should be refilled at an official supplier. The AdBlue tank holds approximately 17 litres.

The AdBlue fill level must be checked when the vehicle is being serviced.

⚠ WARNING

If the AdBlue fill level is too low, the vehicle may not restart after switching the ignition off. The emergency start or jump start will not be possible either!

- Top up with AdBlue at the latest 1,000 km or 600 miles before it runs out.
- Do not allow the AdBlue to run too low.

WARNING

AdBlue is an irritant, corrosive liquid that can cause injuries if it touches the skin, eyes or respiratory organs.







- If AdBlue get in contact with eyes and skin, rinse for at least 15 minutes with plenty of water and seek medical help.
- If the AdBlue is swallowed, wash your mouth with plenty of water for at least 15 minutes. Do not try to provoke vomiting unless recommended by a Doctor. Seek medical advice immediately.

CAUTION

AdBlue damages surfaces such as painted vehicle parts, plastic, items of clothing and carpets. Spilt AdBlue should be removed as quickly as possible using a damp cloth and plenty of cold water.


- If the AdBlue has crystallised, remove with warm water and a sponge.

Control and warning lamps

	It lights up red
The engine cannot be restarted! The level of AdBlue is too low.	Stop the vehicle in a suitable, safe and flat area then top up with the minimum quantity of AdBlue required » page 270.
 together with 	It lights up red
The engine cannot be restarted! AdBlue system malfunction.	Contact a specialised workshop. Have the system checked there.
	It lights up yellow
The AdBlue reserve is low.	Refill AdBlue over the next kilometres or miles as indicated » page 270. SEAT recommends contacting a specialised workshop.
 together with 	It lights up yellow
There is a fault in the AdBlue system or unsuitable AdBlue fluid has been used.	Contact a specialised workshop. Have the system checked there.

Several warning and control lamps should light up for a few seconds when the ignition is switched on, signalling that the function is being verified. They will switch off after a few seconds.



WARNING

Observe the safety warnings »  in Control and warning lamps on page 107.

Information on AdBlue

A message will be displayed on the dash panel around 2,400 km before the next service to indicate that AdBlue must be refilled » page 270. If you ignore this message and do not refill, you will be unable to start the engine afterwards » page 269.

SEAT recommends contacting a specialised workshop. If not possible, it should be partially filled with a minimum 5.0 litres of AdBlue. Only refill using AdBlue expressly approved by SEAT.

When the  and  warning lamps light up simultaneously, there is a fault. SEAT recommends visiting the closest specialised workshop.

AdBlue® is a registered trademark in the US, Germany, the European Union and other »

countries belonging to the German automobile industry association ("Verband der Automobilindustrie e. V.", VDA).

Refilling AdBlue



Fig. 237 At the rear left of the luggage compartment: AdBlue tank, behind a cover panel

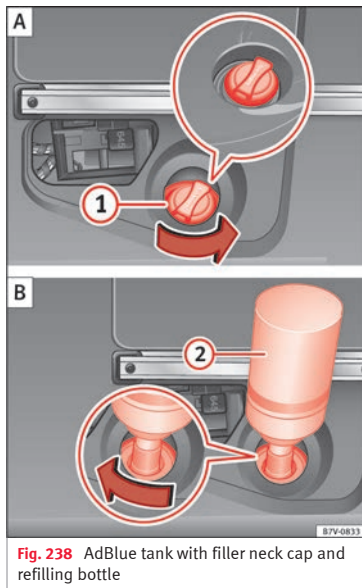


Fig. 238 AdBlue tank with filler neck cap and refill bottle

To refill AdBlue, the vehicle must be on flat ground and not, for example, parked on a kerb or slope. If the vehicle is not on flat ground then the filling indicator cannot measure the filling quantity.

Opening the tank filling neck

- Open the rear lid.
- Rotate the shut off on the cover clockwise » **Fig. 237** and open the cover forwards.
- Unscrew the tank filler neck cap » **Fig. 238** ① anticlockwise.

Refilling AdBlue

Only use AdBlue that is approved by SEAT and that complies with ISO 22241-1 Standard. Only use genuine bottles.

- Observe the instructions and information provided by the refill bottle manufacturer.
- Observe the expiry date.
- Unscrew the cap on the refill bottle.
- Place the refill bottle ② upside down inside the tank filler neck.
- Press the refill bottle against the filler neck and keep in this position.
- **Add at least 5.0 litres of AdBlue (6 bottles).** A lower quantity would be insufficient.
- Wait until the contents of the refill bottle have been poured into the AdBlue tank. Do not crush or damage the bottle!
- Unscrew the liquid bottle anticlockwise and remove it carefully » ①.
- You can tell when the AdBlue tank is full because the bottle will be empty.

Closing the tank filling neck

- Screw on the tank filler neck cap »» Fig. 238
- ① clockwise until it is fully inserted.
- Place the cover and turn the shut off anti-clockwise to close it.

Operations before driving

- **Only** switch the ignition on after refilling.
- Keep the ignition switch on for at least 30 seconds so that the system detects tank refilling.
- Wait 30 seconds before starting the engine!

WARNING

Only keep AdBlue in its original container, tightly shut and in a safe place.

- Never keep AdBlue in empty food cans, bottles or other containers to avoid other people mistaking it for something else.
- Keep the AdBlue out of the reach of small children.

CAUTION

- Only refill using AdBlue expressly approved by SEAT. The use of any other type of AdBlue could cause engine damage!
- AdBlue should never be mixed with water or any other additives. Any type of damage caused by a mixture will not be covered by the warranty.

- **Do not add AdBlue to the diesel fuel tank! Otherwise you may damage the engine.**
- **Never leave the refill bottle in the vehicle. It could become permeable due to temperature changes and bottle damage and the AdBlue could damage the vehicle interior.**

For the sake of the environment

Dispose of the refill bottle in an environment-friendly manner.


Note

Suitable AdBlue refill bottles can be purchased from a technical service centre.

Working in the engine compartment

Introduction

Before working in the engine compartment, make sure that the vehicle is parked on horizontal and firm ground.

The engine compartment of the vehicle is a hazardous area. Never work on the engine or in the engine compartment if you are not familiar with the operations to be carried out, the applicable safety standards and especially if you do not have the necessary instruments, liquids and tools »» ! Have the work

carried out by a specialised workshop if you are uncertain. Negligent work can cause serious injury.

WARNING

If the vehicle moves unexpectedly, this could cause serious injury.

- **Never work under the vehicle if it has not been immobilised. If you must work underneath the vehicle with the wheels in contact with the ground then it should be parked on flat ground, the wheels should be prevented from moving and the key should be removed from the ignition.**
- **If you have to work underneath the vehicle, you must use suitable stands additionally to support the vehicle, there is a risk of accident! The jack is not intended for this kind of work and its failure could lead to severe injuries.**

WARNING

The engine compartment is a dangerous area capable of causing serious injury.

- **For all type of work, always take the utmost precautions, work carefully and note the general safety standards in force. Never take personal risks.**
- **Never work on the engine or in the engine compartment if you are not familiar with the necessary operations. If you are not sure about procedures then visit a specialised workshop to carry out the necessary work.**

Working incorrectly can cause serious injuries.

- Never open the bonnet if you see steam or coolant escaping from the engine compartment. This may cause serious burns. Always wait until you cannot see or hear the sound of steam or coolant coming from the engine compartment.
- Always allow the engine to cool down before opening the bonnet.
- Contact with hot elements of the engine and the exhaust system can cause burns.
- Once the engine has cooled, follow the instructions below before opening the bonnet:
 - Turn on the electronic parking brake and place the gear selector lever in P or the gearbox lever in neutral.
 - Remove the key from the ignition.
 - Keep children away from the engine compartment and never leave them unsupervised.
- When the engine is warm or hot, the cooling system is pressurised. Do not unscrew the cap on the expansion tank when the engine is hot. Otherwise, coolant may spray out under pressure causing burns and serious injury.
 - Carefully and slowly unscrew the cap anticlockwise, gently pressing down on it.
 - Always protect your face, hands and arms from hot coolant and steam using a large, thick cloth.

- When refilling liquids, avoid spilling them on parts of the engine and the exhaust system. Spilled liquids could cause a fire.

WARNING

The high voltages of the electrical system can give electric shocks as well as causing burns and serious injury and possibly even death!

- Never cause short circuits in the electrical system. The battery could explode.
- To minimise the risk of electric shock and serious consequences while the engine is running or starting the engine, note the following:
 - Never touch the electrical wiring of the ignition system.
 - Never touch electric cables or the gas discharge lamps.

WARNING

In the engine compartment, there are rotating parts that could cause serious injury.

- Never place your hands on or near the radiator fan. Touching the rotor blades could seriously harm you. The ventilator works according to the engine temperature and could start suddenly even when the ignition is turned off and the key is removed.
- If any work has to be performed when the engine is started or with the engine running, there is an additional, potentially fatal, safety risk from rotating parts, such as the drive

belts, alternator, radiator fan, etc., as well as from the high-voltage ignition system. Always work with the utmost caution.

- Always make sure that no parts of your body, jewellery, ties, loose clothing and long hair can be trapped by the rotating parts of the engine. Before any work, remove ties and jewellery (necklaces, etc), tie long hair back and tie all items of loose clothing to your body to make sure that they cannot be trapped by engine components.
- Take extreme caution when operating the accelerator and remain attentive. The vehicle could move, even with the electronic parking brake activated.
- Always make sure you have not left any objects, such as cleaning cloths and tools, in the engine compartment. If any object is left in the engine compartment, this could cause malfunctions, engine faults and even a fire.

WARNING

Refill liquids and certain materials can catch fire easily in the engine compartment, causing a fire and serious injury!

- Never smoke.
- Never work close to places exposed to flames or sparks.
- Never pour service fluids over the engine. These fluid may ignite hot engine parts and cause injuries.

• If it is necessary to work on the fuel system or the electrical system, please follow the instructions below:

- Always disconnect the vehicle battery. When disconnecting the battery, ensure that the vehicle is unlocked otherwise the anti-theft alarm will be triggered.
- Never work close to heaters, heat sources or places exposed to flames or sparks.
- Always keep a recently serviced and perfectly working fire extinguisher close by.
- Never cover the engine with additional insulating materials such as a blanket. Risk of fire!

⚠ CAUTION

When refilling or changing service liquids, ensure that you put the liquids into the right tank. Making a mistake when refilling could cause serious malfunctions and damage the engine!

🌿 For the sake of the environment

Service fluids leaks are harmful to the environment. For this reason you should make regular checks on the ground underneath your vehicle. Take the vehicle to a specialised workshop to be checked if you see stains, oil or other fluids on the ground. Collect any spill service fluids and allow a professional to dispose of them.

Opening and closing the bonnet

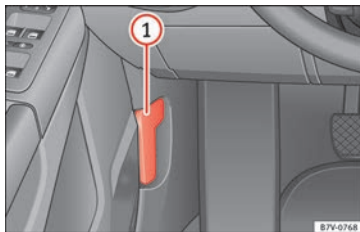


Fig. 239 In the footwell on the driver side: Lever for unlocking the bonnet



Fig. 240 Release lever to open the bonnet in the radiator grille

Opening the bonnet

The lever to open the bonnet can only be used if the driver door is open.

- Before opening the bonnet, make sure that the windscreen wiper arms are in place against the windscreen »» ⚠.
- Open the driver door.
- Pull the release lever »» **Fig. 239** in the direction of the arrow. The bonnet is released from the lock carrier by a spring mechanism »» ⚠.
- Lift the bonnet using the release lever »» **Fig. 240** (arrow) and open the bonnet fully. The bonnet is held open thanks to the gas strut.

Closing the bonnet

- To close the bonnet, pull it down to overcome the gas strut pressure »» ⚠.
- Allow the bonnet to fall into the lock carrier. *Do not press down.*

If the bonnet is not correctly closed, open it once again and close it correctly.

The bonnet is correctly closed when it is flush with the corresponding parts on the body-work.

⚠ WARNING

If the bonnet is not correctly closed, it could suddenly open while driving leaving the driver without visibility. This could result in a serious accident. »»

- After closing the bonnet, always check that it is properly secured by the locking mechanism in the lock carrier. The bonnet must be flush with the surrounding body panels.
- While driving, if you notice that the bonnet is not correctly closed then stop immediately and close it correctly.
- Only open and close the bonnet when there is nobody within its range.

ⓘ CAUTION

- To avoid damage to the bonnet and to the windscreen wiper arms, only open it when the windscreen wipers are in place against the windscreen.
- Before driving, always lower the wiper arms.

Checking fluid levels

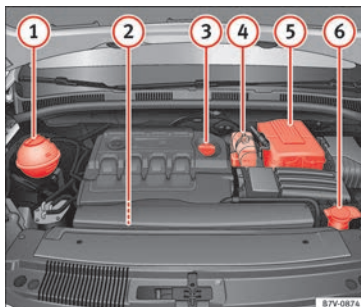


Fig. 241 Diagram for the location of the various elements.

From time to time, the levels of the different fluids in the vehicle must be checked. Never fill with incorrect fluids, otherwise serious damage to the engine may be caused.

- ① Coolant fluid deposit
- ② Engine oil dipstick
- ③ Oil filler neck
- ④ Brake fluid reservoir
- ⑤ Vehicle battery (underneath a cover)
- ⑥ Windscreen washer fluid reservoir

The checking and refilling of service fluids are carried out on the components men-

tioned above. These operations are described in »» page 271.

Overview

Further explanations, instructions and restrictions on the technical data are contained as of »» page 297

Engine oil

Introduction

⚠ WARNING

Incorrectly handling engine oil can cause injury and serious burns.



- Always protect your eyes when handling engine oil.
- Oil is toxic and must be kept out of the reach of children.
- Engine oil should only be kept in its original packaging; the same goes for used oil until it is disposed of.
- Never store engine oil in empty food containers or bottles as other people may accidentally drink it.
- Regular contact with engine oil can be bad for the skin. If you come into contact with engine oil, wash your skin with soap and water.
- With the engine running, the engine oil gets extremely hot and can cause severe skin



burns. Always wait until the engine has fully cooled.

 **For the sake of the environment**


Similar to the other service liquids, spilled engine oil can be bad for the environment. Collect these liquids in suitable containers and dispose of them while respecting the environment.

Warning and control lamps

	It lights up
Insufficient engine oil.	Switch the ignition off. Check the engine oil level » page 276.
	Flashes
Engine oil sensor faulty.	Contact a specialised workshop. Have the engine oil sensor checked. Meanwhile, check the oil level manually.

	Flashes
Engine oil pressure too low.	<p> Stop the vehicle!</p> <p>Switch off the engine. Check the engine oil level.</p> <p>- If the warning lamp flashes although the oil level is correct, do <i>not</i> continue driving or leave the engine running. Otherwise, the engine could be damaged. Seek specialist assistance.</p>



WARNING

Observe the safety warnings »  in Control and warning lamps on page 107.

Engine oil specifications

Replacement engine oil must strictly comply with the specifications.

The correct oil must be used to ensure the correct operation and long service life of the engine. The engine comes with a high-quality multigrade oil that can generally be used all year round.

Only use an engine oil that complies to SEAT standards whenever possible » . If you wish to maintain the long-life service duration, only engine oils approved for this service according to the corresponding VW standard (»  table on page 41) may be used. All oils indicated are **synthetic multigrade oils**.

Engine oils are being continuously further developed. Technical services are constantly updated with any modifications. SEAT therefore recommends that you have the engine oil changed by a technical service.

CAUTION

- **Only use engine oils whose specifications are expressly approved by SEAT. The use of any other type of oil could cause engine damage!**

Checking engine oil level

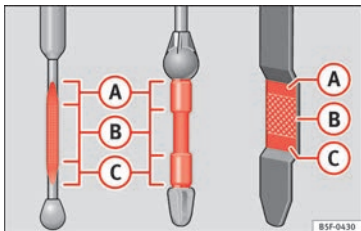


Fig. 242 Marked engine oil dipstick





Fig. 243 In the engine compartment: Engine oil filler cap.

Read the additional information carefully

»  page 40

Preparations

- Park the vehicle on flat ground so that the engine oil reading is correct.

- Stop the engine and wait a few minutes for the oil to drain back into the sump. When the engine has cooled down, immediately check the oil level and top up if necessary.
- Open the bonnet  » page 271.
- The engine oil filler neck can be recognised by the symbol  on the cap » Fig. 243 and the dipstick by its coloured handle.

Checking the engine oil level



- Pull out the dipstick and wipe it on a clean cloth.
- Replace the dipstick, pushing it in as far as it will go. If the dipstick has a mark, when you reintroduce it this mark should slot into the corresponding groove located on the upper end of the tube.
- Remove the oil dipstick again and check the engine oil level.
- After reading the oil level, replace the dipstick in the tube completely.

Adding oil after checking the level

Only add engine oil in small quantities and in steps:

- Unscrew the cap from engine oil filler neck on the cylinder head » Fig. 243. If you are not sure where the cap is, request help from a specialist.

- Only refill using approved SEAT engine oil in small quantities (no more than 0.5 l) » page 275.


- To avoid adding too much oil, each time you add a quantity, wait until the oil has flowed into the crankcase so that it can be measured with the dipstick.
- Check the oil level before adding any more oil. Do not top up with too much engine oil » .
- When the oil level is at least in the » Fig. 242  zone, insert the dipstick into the tube fully to avoid engine oil escaping when the engine is running.
- After topping up the oil, ensure that the cap is screwed on to the filler neck correctly.

WARNING

Oil could catch fire if it comes into contact with hot engine components. This could lead to a fire, explosion and severe injuries.

- Always ensure that after topping of oil, the engine oil filler cap is correctly tightened. This will avoid engine oil spilling onto hot engine parts when the engine is running.

CAUTION

- If the engine oil level is above the area » Fig. 242  do not start the engine. Seek specialist assistance. Otherwise catalytic converter and engine damage may occur.

- When refilling or changing service liquids, ensure that you put the liquids into the right tank. Making a mistake when refilling could cause serious malfunctions and damage the engine!

For the sake of the environment

The oil level must never be above area

» Fig. 242 (A). Otherwise oil can be drawn in through the crankcase breather and escape into the atmosphere via the exhaust system.

Engine oil consumption

The consumption of engine oil can be different from one engine to another and can vary during the useful life of the engine.

Depending on driving style and the conditions of use, the consumption of engine oil can reach 1 litre every 2,000 km (one quarter of a gallon every 1,200 miles); for new vehicles, this could be higher for the first 5,000 km (3,000 miles). For this reason the engine oil level must be checked at regular intervals, preferably when filling the tank and before a journey.

Topping up engine oil

Read the additional information carefully

»  page 40

The engine oil must be changed regularly according to the specifications of the Maintenance Programme.

Due to the problems linked with disposing of used oil and the need for suitable tools and special knowledge, always visit a specialised workshop to have the engine oil and filter changed. SEAT recommends taking your car in for technical service.

Detailed information on the service intervals is shown in the Maintenance Programme.

WARNING

If, in exceptional circumstances, you must change the engine oil yourself, please note the following:

- Wear eye protection.
- Always wait until the engine has completely cooled to avoid being burned.
- Always keep your arms horizontal when unscrewing the oil drainage bolt so that it does not run down your arms.
- Use a suitable container large enough to collect all of the used oil in the engine.
- Never collect engine oil in empty food containers, cans, bottles or other containers as not all people are able to identify engine oil.
- Oil is toxic and must be kept out of the reach of children.

CAUTION

No additives should be used with engine oil. This could result in engine damage. Any damage caused by the use of such additives would not be covered by the factory warranty.

For the sake of the environment

- Before changing the engine oil, find a suitable location or service for proper disposal.
- Always dispose of engine oil with the utmost respect for the environment. Never dispose of used engine oil in places such as a garden, woods, drains, roads, paths, rivers and drainage systems.

Engine coolant

Introduction

WARNING

Engine coolant is toxic!

- Only keep engine coolant in its original container, tightly shut and in a safe place.
- Never store engine coolant in empty food containers or bottles as other people may accidentally drink it.
- Always keep engine coolant out of reach of children.

- Ensure that the proportion of engine coolant additive corresponds to the lowest outside temperature to which the vehicle will be exposed.
- If the outside temperature is extremely low, the engine coolant could freeze causing the

vehicle to stop. As this would also cause the heating to stop working, passengers without warm clothing could freeze.

ance with legislation and with the utmost respect for the environment.

 For the sake of the environment

Coolants and additives can contaminate the environment. Collect any spilt fluids in suitable containers and dispose of them in accord-

Warning lamp and coolant temperature indicator

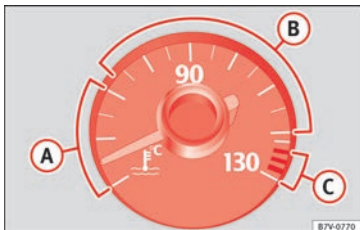





Fig. 244 Coolant temperature gauge on dash panel insert.


- A** Engine cold
- B** Normal temperature
- C** Warning area

When driving normally, the needle will remain in the middle area. The temperature may also rise when the engine is working hard, especially at high outside temperatures and so the indicator will move quite far to the right-hand side.


Several warning and control lamps light up for a few seconds when the ignition is switched on, signalling that the function is being verified. They will switch off after a few seconds.

Checking and refilling levels


It lights up	Gauge position	Possible cause	Solution
	Warning area C	Excessive engine coolant temperature.	 Stop the vehicle! Stop the vehicle safely as soon as possible. Switch off the engine and wait for it to cool down and for the needle to return to the normal area. Check the engine coolant level »» page 280.
	Normal area B	Insufficient engine coolant level.	Check the engine coolant when the engine has cooled and, if it is low, refill with engine coolant »» page 280. Although the coolant level is correct, there is a fault.
	--	Engine coolant system faulty.	 Do not drive any further. Obtain professional assistance.
--	Cold area A	--	Avoid revving the engine too much or making it work hard while it has not reached normal service temperature.

Flashes	Gauge position	Possible cause	Solution
	--	Engine coolant system faulty.	Seek specialist assistance.

WARNING

Observe the safety warnings **»»**  in Control and warning lamps on page 107.

Coolant specifications

Read the additional information carefully **»»**  page 41

WARNING

If there is not enough anti-freeze in the coolant system, the engine may fail leading to serious damage.

- Please make sure that the percentage of additive is correct with respect to the lowest expected ambient temperature in the zone in which the vehicle is to be used.

- When the outside temperature is very low, the coolant could freeze and the vehicle would be immobilised. In this case, the heating would not work either and inadequately dressed passengers could die of cold.

CAUTION

The original additives should never be mixed with coolants which are not approved by SEAT. Otherwise, you run the risk of causing

severe damage to the engine and the engine cooling system.

- If the fluid in the expansion tank is not purple but is, for example, brown, this indicates that the G13 additive has been mixed with an inadequate coolant. The coolant must be changed as soon as possible if this is the case! This could result in serious faults and engine damage.

For the sake of the environment

Coolants and additives can contaminate the environment. If any fluids are spilled, they should be collected and correctly disposed of, with respect to the environment.

Checking the coolant level and topping up

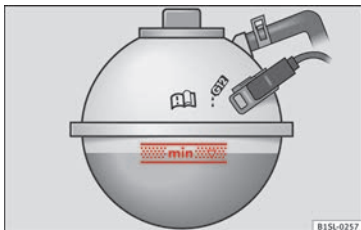


Fig. 245 In the engine compartment: Marking on coolant expansion tank



Fig. 246 In the engine compartment: Coolant expansion tank cap

If the coolant level is low, the coolant warning indicator will light.

Preparations

- Park the vehicle on even, flat and firm ground.
- Allow the engine to cool » » » ⚠.
- Open the bonnet ⚠ » » » page 271.
- The coolant expansion tank is easily recognisable because of the 🖐 symbol on the cap » » » **Fig. 246**.

Checking the engine coolant level

- When the engine is cold, check the coolant level using the side marking on the expansion tank » » » **Fig. 245**.
- If the level is below the MIN minimum mark, top up with coolant. When the engine is hot it may be slightly above the marked area.

Topping up the engine coolant level

- Always protect your face, hands and arms from hot coolant and steam using a large, thick cloth over the coolant expansion tank cap.
- Remove the cap very carefully » » » ⚠.
- Only refill using **new** engine coolant according to SEAT specifications (» » » page 279) » » » 🚫.
- The engine coolant level should be between the marks on the coolant expansion tank » » » **Fig. 245**. **Do not exceed the top level of the marked area** » » » 🚫.
- Screw on the cap tightly.

- If, in the event of an emergency, you have no coolant that is compliant to the required specifications (» » » page 279), do not use another type of additive. Instead, top up with **distilled water only** » » » 🚫. Then re-establish the correct proportion of the mixture with the correct additive as soon as possible » » » page 279.

⚠ WARNING

Hot vapours and coolant can cause serious burns.

- **Never open the coolant expansion tank if steam or coolant is coming from the engine compartment. Wait until you cannot see or hear any steam or coolant escaping.**
- **Always wait until the engine has completely cooled before very carefully opening the expansion tank cap. Contact with hot elements of the engine can cause skin burns.**
- **When the engine is warm or hot, the cooling system is pressurised. Do not unscrew the cap on the expansion tank when the engine is hot. Otherwise, coolant may spray out under pressure causing burns and serious injury.**
 - Carefully and slowly unscrew the cap anti-clockwise, gently pressing down on it.
 - Always protect your face, hands and arms from hot coolant and steam using a large, thick cloth.

- When refilling liquids, avoid spilling them on parts of the engine and the exhaust system. Spilled liquids could cause a fire. Under specific circumstances, the ethylene glycol can catch fire.

ⓘ CAUTION

- Only fill with distilled water. Any other type of water may lead to considerable rusting in the engine due to its chemical components. This could consequently damage the engine. If you have not used distilled water but another type of water to top up the coolant, a specialised workshop must immediately replace all of the fluid in the engine cooling system.
- Only top up coolant to the top level of the marked area » Fig. 245. Otherwise the excess coolant will be forced out of the cooling system when the engine is hot, causing damage.
- If a lot of liquid coolant has been lost, wait for the engine to **cool down completely** before adding coolant. Extensive coolant loss is an indication of leaks in the engine cooling system. Have the engine cooling system inspected immediately by a specialised workshop. Otherwise engine damage may occur.
- When refilling service liquids, ensure that you put the liquids into the right tank. Making a mistake when refilling could cause serious malfunctions and damage the engine!

Brake fluid

Checking the brake fluid level



Fig. 247 In the engine compartment: brake fluid reservoir cap.

Read the additional information carefully

» 📖 page 42

In the course of time, the brake fluid absorbs water from the ambient air. If there is too much water in the brake fluid, the brake system could be damaged. In addition, the boiling point of the brake fluid is significantly lowered. When the brake fluid contains too much water and the brakes are subject to considerable forces, bubbles of water vapour can form in the system. These bubbles can significantly reduce braking power, notably increasing braking distance, and could even result in the total failure of the brake system. Ensuring that the brake system is always functioning correctly is essential for your own

safety and the safety of other road users

» ⚠️.

Brake fluid specifications

SEAT have developed a special brake fluid optimised for the brake systems of their vehicles. To ensure the optimum working of the brake system, SEAT recommends the use of brake fluid in accordance with the **VW 501 14 standard**. If this brake fluid is not available or another brake fluid is used for different reasons, use a brake fluid that complies with the United States standard FMVSS 116 DOT 4 or the German standard DIN ISO 4925 CLASS 4

» ⚠️.

Brake fluids conforming to the standard VW 501 14, fulfil the American requirements of the FMVSS 116 DOT 4 standard and the German DIN ISO 4925 CLASS 4 standard. However, fluids that comply with the US FMVSS 116 DOT 4 standard or the German DIN ISO 4925 CLASS 4 standard do not necessarily comply with the VW 501 14 standard. Always check the information on the brake fluid container and ensure that you are using suitable brake fluid.

A suitable brake fluid can be obtained from technical service centres.

»

Brake fluid level

The level of the brake fluid reservoir should always be between the **MIN** and **MAX** marks, or above the **MIN** mark »» ⚠.

It is not always possible to check the level of the brake fluid, as in some models the engine components make it difficult to see the brake fluid reservoir. If you cannot read the exact brake fluid level, consult a specialist.

The brake fluid level drops slightly when the vehicle is being used due to wear of the brake pads and the automatic readjustment of the brake.

Changing the brake fluid

The brake fluid should be changed in accordance with the instructions given in the Maintenance Programme. Have the brake fluid changed by a specialised workshop. SEAT recommends taking your car in for technical service. This means that only brake fluid complying with the required specifications will be used.

⚠ WARNING

If the brake fluid level is low or unsuitable/old brake fluid is used, the brake system may fail or braking power may be reduced.

- Check the brake system and the brake fluid level regularly!

- The brake fluid should be changed regularly in accordance with the instructions given in the Maintenance Programme.

• When the brake fluid is used and brakes are subjected to extreme braking forces, bubbles of vapour form in the brake system. These bubbles can significantly reduce braking power, notably increasing braking distance, and could result in the total failure of the brake system.

• Only used brake fluid that conforms to the VW 501 14 standard, FMVSS 116 DOT 4 standard or even the DIN ISO 4925 CLASS 4 standard. Other types of brake fluid could affect brake operation and reduce braking power. Do not use a brake fluid if the container does not specify compliance with the VW 501 14, FMVSS 116 DOT 4 or DIN ISO 4925 CLASS 4 standards.

- The replacement brake fluid must be new.
- Always ensure that you use suitable brake fluid. Do not use a brake fluid if the container does not specify compliance with the VW 501 14, FMVSS 116 DOT 4 or DIN ISO 4925 CLASS 4 standards.

⚠ WARNING

Brake fluid is poisonous.

- To reduce the risk of poisoning, do not keep brake fluid in drinks bottles/containers or similar. Other people could drink from these recipients even if the contents are clearly marked.

- Always keep brake fluid in the original container; keep it correctly sealed and out of reach of children.

ⓘ CAUTION

Brake fluid damages the vehicle paintwork. Wipe off any brake fluid from the paintwork immediately.

♻ For the sake of the environment

Brake fluid is an environmental pollutant. Collect any spilt service fluids and allow a professional to dispose of them.

Windscreen washer reservoir

Checking and topping up the windscreen washer reservoir



Fig. 248 In the engine compartment: windscreen washer reservoir top

Read the additional information carefully

» page 42

Check the level in the windscreen washer tank regularly and top up as required.

- Open the bonnet » page 271.
- The washer reservoir is marked with the symbol on the cap » **Fig. 248**.
- Check there is enough water in the reservoir.
- To top up, mix water with a window cleaner recommended by SEAT » . Please follow the instructions for use found on the packaging.

- In cold weather, a special antifreeze should also be added to prevent the water from freezing » .

Filling amounts

The capacity of the tank is approximately 3 litres; in vehicles with a headlight washer system, it is approximately 7 litres.

WARNING

Never mix an unsuitable antifreeze or other similar additives with the windscreen washer water. A greasy layer may be formed on the windscreen which will impair visibility.

- Use clean water with a window cleaner recommended by SEAT.
- If necessary, add a suitable antifreeze to the water in the reservoir.

CAUTION

- Do not mix cleaning products recommended by SEAT with other products. This could lead to flocculation and may block the windscreen washer jets.
- When topping up service fluids, make absolutely certain that you fill the fluids into the correct reservoirs. Using the wrong fluids could cause serious malfunctions and engine damage!

Vehicle battery

Introduction

The battery is a component of the vehicle's electrical system.

Never work on the electrical system without fully understanding the operations required, the applicable safety standards and without the correct tools » ! If required, have any work carried out by a specialised workshop. SEAT recommends taking your car in for technical service. Negligent work can cause serious injury.

Location and number of batteries in the vehicle

The battery is located in the engine compartment.

Explanation of the warning indications on the vehicle's battery

	Wear eye protection!
	Battery acid is extremely corrosive. Always wear protective gloves and eye protection!
	Fires, sparks, open flames and smoking are prohibited.
	A highly explosive mixture of gases is released when the battery is under charge. »



Keep children away from acid and batteries!

WARNING

Working on the vehicle battery and the electrical system can cause corrosion, fire and electric shocks. Always read and take into account the following warnings and safety standards before carrying out any work:

- Before working on the battery, switch off the engine, the ignition and all electrical devices then disconnect the negative connection on the battery.
- Keep children away from acid and the battery itself!
- Wear eye protection.
- Battery acid is very corrosive and caustic. It can burn skin and cause blindness. When handling the battery, protect yourself from splashes of acids, above all your hands, arms and face.
- Do not smoke and never work close to places exposed to flames or sparks.
- Avoid sparks and electrostatic discharges when working with cables and electrical devices.
- Never short the battery terminals.
- Never use a damaged battery. It can explode. Replace a damaged battery immediately.

- Replaced damaged or frozen batteries as soon as possible. A flat battery can also freeze at temperatures close to 0°C (+32°F).
- For vehicles with the battery in the luggage compartment: Check that the battery gas ventilation hose is securely attached.

CAUTION

- Never disconnect the battery if the ignition is switched on or if the engine is running. This could damage the electrical system or electronic components.
- Do not expose the battery to direct sunlight over a long period of time, as the intense ultraviolet radiation can damage the battery housing.
- If the car is left standing for long periods, protect the battery from extreme cold temperature so that it does not “freeze up” and become damaged.

Warning lamp



It lights up

Faulty generator.

Contact a specialised workshop. Have the electrical system checked. Disconnect any unnecessary electrical devices. The generator does not charge the battery while the vehicle is in motion.

Several warning and control lamps light up for a few seconds when the ignition is switched on, signalling that the function is being verified. They will switch off after a few seconds.

WARNING

If the warning lamps and messages are ignored, the vehicle may stall in traffic, or may cause accidents and severe injuries.

- Never ignore the warning lamps or text messages.
- Stop the vehicle safely as soon as possible.

CAUTION

Failure to heed the control lamps and text messages when they appear may result in faults in the vehicle.

Checking the electrolyte level of the vehicle battery

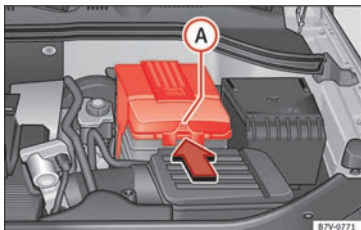


Fig. 249 In the engine compartment: remove the lid from the vehicle's battery.

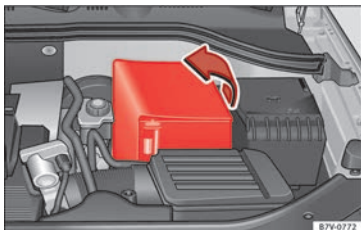


Fig. 250 In the engine compartment: lift off the cover from the vehicle's battery.

Read the additional information carefully
» page 42

The battery's electrolyte level should be checked regularly in high-mileage vehicles,

in hot countries and in older batteries. Other batteries do not require maintenance.

Vehicles with a Start-Stop system (» page 209) are equipped with a special battery marked with the letters "AGM". For technical reasons, it is not possible to check the electrolyte level of these batteries

Preparations

- Prepare the vehicle for work in the engine compartment » page 271
- Open the bonnet » page 271.

Opening the battery cover

The battery covers are different depending on the engine size of the vehicle:

- *In the case of a lid:* press the tab » **Fig. 249**
- **A** in the direction of the arrow and pull the cover upwards.
- *In the case of a cover:* fold the cover to one side to remove » **Fig. 250**.

Checking the battery electrolyte level

- Make sure there is sufficient lighting to clearly recognise the colours. Never use flames or flashing objects as a light source.
- Depending on the level of acid, the Magic eye on the top of the battery will change colour.

Colour indicator	Necessary operations
Light yellow or Colourless	The electrolyte level of the vehicle's battery is too low. Have the battery checked and, where applicable, replaced by a specialised workshop.
Black	The electrolyte level of the vehicle's battery is correct.

WARNING

Working with the vehicle battery involves a risk of corrosion, explosions or electric shock.

- **Never tilt the vehicle battery. Battery acid could spill out of the openings for the release of gases and cause corrosion damage.**
- **Never open the vehicle battery.**
- **If battery acid splashes on you, immediately rinse your eyes and skin abundantly with water for several minutes. Then seek medical care immediately.**
- **If acid is swallowed by mistake, consult a doctor immediately.**

Charging, replacing and connecting or disconnecting the battery

Charging the battery

The vehicle battery should be charged by a specialised workshop only, as batteries using special technology have been installed »

and they must be charged in a controlled environment »» ⚠. SEAT recommends taking your car in for technical service.

Replacing a vehicle battery

The battery has been developed to suit the conditions of its location and has special safety features. If the battery must be replaced, consult a technical service for information on electromagnetic compatibility, the size and maintenance, performance and safety requirements of the new battery in your vehicle before you purchase one. SEAT recommends you have the battery replaced by a technical service.

Use only maintenance-free genuine batteries conforming to TL 825 06 and VW 7 50 73 Standards. These standards must be dated April 2008 or later.

Start-Stop systems (»» page 209) are equipped with a special battery. Therefore, it must only be replaced with a battery of the same specifications.

Disconnecting the vehicle's battery

If you must disconnect the battery from the electrical system, please note the following:

- Switch off the ignition and all electrical equipment.

- The vehicle must be unlocked before disconnecting the battery, otherwise the alarm will be triggered.

- First disconnect the negative cable and then the positive »» ⚠.

Connecting the vehicle's battery

- Before reconnecting the battery, switch off the engine and all electrical devices.
- First reconnect the positive cable and then the negative »» ⚠.

Different control lamps may light up after connecting the battery and switching the ignition on. They will be turned off after a short trip at a speed of between 15-20 km/h (10-12 mph). If the warning indicators remain lit, please visit a specialised workshop to have the vehicle checked.

If the battery has been disconnected for a long time, it is possible that the next service date is not displayed or calculated correctly »» page 102. Respect the maximum service intervals permitted »» Booklet Maintenance Programme.

Vehicles with Keyless Access (»» page 117): if, after connecting the battery, the ignition cannot be switched on, lock and unlock the vehicle from outside. Then try to switch on the ignition again. If the ignition does not work, seek professional assistance.

Automatically disconnecting devices

The intelligent vehicle electrical system automatically implements a range of measures to prevent the battery from discharging when high demands are made on it:

- the idling speed is increased so that the alternator provides more electricity.
- where necessary, the power of the most powerful devices is reduced or even completely disconnected.
- On starting the engine, the power supply from the 12-volt power sockets and the cigarette lighter may be interrupted for a short time.

The on-board management program cannot always prevent the battery from running flat. For example, if the ignition is left on for a long period with the engine off or if the side lights or parking lights are left on while the vehicle is stationary.

Why does the battery run flat?

- When stationary for a long time without starting the engine, particularly if the ignition is switched on.
- Use of electrical devices with the engine switched off.
- If the auxiliary heater is running »» page 180.

Wheels and tyres

Tyres

Introduction

The SEAT Alhambra is equipped as standard with anti-puncture technology tyres (Conti-Seal). In the event of a puncture or air leak of up to 5 mm, the tyre seals the hole with a protective layer inside the tread.

The inclusion of this technology means that there is no type of spare wheel included in the vehicle's equipment.

SEAT recommend that all work on tyres and wheels is carried out by a specialised workshop. These workshops have the necessary special tools and replacement parts, trained personnel and facilities for disposing of the old tyres while respecting the environment. SEAT recommends taking your car in for technical service.

⚠ WARNING

The vehicle cannot be totally controlled or braked if the tyres (new or used) are worn or damaged.

- **Incorrect use of wheels and tyres could make driving more dangerous and result in serious accidents and damage.**

lighter. This could damage the vehicle's electrical system.

♻ For the sake of the environment

- **Dispose of the battery in an environment-friendly manner. Batteries contain toxic substances such as sulphuric acid and lead.**
- **Battery acid can contaminate the environment. If it has leaked use adequate care collecting it (gloves and protective glasses), and dispose of it correctly.**

⚠ WARNING

Incorrectly securing the battery or using the wrong battery can cause short-circuits, fire and serious injuries.

- **Always use only maintenance free batteries that do not run flat alone and whose properties, specifications and size correspond to the standard battery. The specifications are indicated on the battery case.**

⚠ WARNING

A highly explosive mixture of gases is released when the battery is under charge.

- **The batteries should be charged in a well-ventilated room only.**
- **Never charge a frozen or recently thawed battery. A flat battery can also freeze at temperatures close to 0°C (+32°F).**
- **Always replace a battery which has frozen.**
- **Battery cables not correctly connected may cause a short circuit. Reconnect first the positive cable and then the negative cable.**

ⓘ CAUTION

- **Never disconnect the battery if the ignition is switched on or if the engine is running. This could damage the electrical system or electronic components.**
- **Never plug accessories that supply current, such as solar panels or a battery charger, to the 12-volt power sockets or the cigarette**

- All four wheels must be fitted with radial tyres of the same type, size (rolling circumference) and the same tread pattern.
- New tyres do not give maximum grip and will not have reached their maximum braking capacity to start with, and therefore need running in. To prevent accidents and major damage, extreme caution should be taken for the first 500 km (310 miles).
- Check tyre pressures regularly and ensure they are maintained at the pressures indicated. If the tyre pressure is too low, they could overheat, resulting in tread detachment or even burst tyres.
- Never drive on damaged (punctured, cut, cracked or dented) or worn tyres. Driving on damaged or worn tyres could result in burst tyres, serious accidents or damage. Worn or damaged tyres must be replaced immediately.
- Never exceed the maximum permitted speed or loads specified for the type of tyre fitted on your vehicle.
- The effectiveness of driver and brake assist systems also depends on the grip of the tyres.
- If you notice unusual vibration or if the vehicle pulls to one side when driving, stop the car immediately and check the tyres and wheels for damage.
- To minimise the risk of losing control of the vehicle or causing a serious accident, never undo the bolted joints of beadlock wheels.

- Never mount used tyres or wheels if you are not sure of their previous history. They may be damaged, although the damage is not immediately visible.
- Old tyres, even if they have never been used, may lose air or burst unexpectedly while driving, resulting in serious accident or damage. If tyres are over six years old, they should only be used in an emergency and with extreme caution.

Note

- For technical reasons, it is not generally possible to use the wheels from other vehicles. In some cases, this may also be true for the same model of wheel. Please refer to the vehicle documentation or ask at a technical service.

Handling tyres and wheels

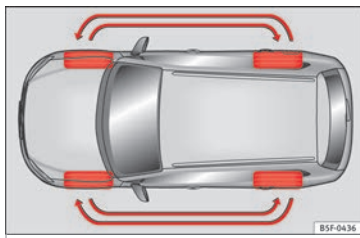


Fig. 251 Diagram for changing wheels.


The tyres of a vehicle are the components which are subjected to most stress and are the most underestimated. Tyres are very important, as the support offered by their narrow surface is the only point of contact between the vehicle and the road.

The service life of tyres is dependent on tyre pressure, driving style, the care they receive and the correct fitting.

The tyres and wheel rims are an essential part of the vehicle's design. The tyres and rims approved by SEAT are specially matched to the characteristics of the vehicle and our critical to good road holding and safe handling.

Avoiding damage to tyres and wheels

- If you have to drive over a kerb or similar obstacle, drive very slowly and as near as possible at a right angle to the kerb.
- Inspect the tyres regularly for damage (punctures, cuts, cracks, dents).
- Remove any foreign bodies found on the outside of the tyre tread and ensure that **they have not passed through the wall of the tyre** » page 293.
- In addition, the instructions for tyre control systems should always be observed.
- Replace damaged or worn tyres as soon as possible » page 293.

- Regularly check tyres for non-visible damage » page 293.
- Never exceed the maximum permitted speed or loads specified for the type of tyre fitted on your vehicle » page 294.
- Do not allow tyres to come into contact with aggressive substances, grease, oil, fuel or brake fluid » .
- Lost valve caps should be replaced immediately.

Changing wheels


To ensure that the wear is equal on all tyres the wheels should be changed round from time to time according to the system » Fig. 251. The useful life of all the tyres will then be about the same time.

SEAT recommends you take the vehicle to a specialised workshop to have the tyres changed.

Tyres over 6 years old

Tyres are subject to an ageing process as a result of physical and chemical processes. This may affect their performance. Tyres which are stored for long periods of time without being used, harden and become more fragile than tyres which are in constant use.

SEAT recommends that tyres over six years old are replaced with new tyres. This also applies to tyres which appear to be in perfect

condition on the outside and which have a tread depth within the values stipulated by the Law » .

The date of manufacture, part of the tyre identification number (TIN), indicates the age of the tyre » page 294.

Storing tyres

Mark tyres when you remove them to indicate the direction of rotation (left, right, forwards, backwards). This ensures you will be able to mount them correctly when you replace them. When removed, the wheels and/or tyres should be stored in a cool, dry and preferably dark location. Do **not** place tyres mounted on the wheel in a vertical position.

Protect tyres not mounted on wheels from dirt by storing them in suitable bags and standing them on the ground on their tread.

WARNING

Aggressive fluids or substances could result in visible or invisible damage with the consequent risks.

- **Always ensure that tyres do not come into contact with chemical products, oil, grease, fuel, brake fluid or other aggressive substances.**

WARNING

Old tyres, even if they have never been used, may lose air or burst unexpectedly while driving, resulting in serious accident or damage.

- **If tyres are over six years old, they should only be used in an emergency and with extreme caution.**

For the sake of the environment

Old tyres must be disposed of by qualified personnel according to the laws in the country concerned.

Wheels

The design of wheel bolts is matched to the rims. If different rims are fitted, the correct wheel bolts with the right length and correctly shaped bolt heads must be used. This ensures that wheels are fitted securely and that the brake system functions correctly » page 85.


For technical reasons, it is not generally possible to use the wheels from other vehicles. In some cases, this may also be true for the same model of wheel.

The tyres and rims approved by SEAT are specially matched to the characteristics of the vehicle and are critical to good road holding and safe handling. »


Wheel bolts

Wheel bolts must be tightened to the correct torque »» page 85.

Beadlock wheel rims

Beadlock wheel rims have various components. These are joined together by special bolts using a special procedure. This ensures good performance, a better seal, improved safety and wheel run out. Therefore, worn rims should always be replaced and must only be repaired in a specialised workshop. SEAT recommends visiting a technical service »» .

Wheel rims with bolted trims

Wheel rims may be fitted with interchangeable trim parts which are attached to the rim using self-locking bolts. Worn trims should only be replaced at a specialised workshop. SEAT recommends visiting a technical service »» .

WARNING

The use of worn or damaged wheel rims could make driving more dangerous and result in serious accidents and damage.

- Only wheel rims which have been approved for use with your vehicle should be used.
- Inspect wheel rims regularly for damage and replace as required.

WARNING

If the bolted joints of wheel rims with bolted ring trims are not correctly tightened or loosened, this could result in serious accident.



- Never loosen the bolted joints of wheel rims with bolted ring trims.
- Any work relating to wheel rims with bolted rims should be carried out at specialised workshop. SEAT recommends taking your car in for technical service.

Note

A SEAT Service Centre should be consulted to find out whether wheels or tyres of different sizes to those originally fitted by SEAT can be fitted, and to find out about the combinations allowed between the front axle (axle 1) and the rear axle (axle 2).


Replacement of wheel rims and new tyres

New tyres

- When tyres are new, drive with extreme caution for the first 500 km (310 miles), as all tyres need to be *run in*. Tyres which have not been run in do not have such good grip or »»  braking capacity »» .
- All four wheels must be fitted with radial tyres of the same type, size (rolling circumference) and the same tread pattern.

- The tread depth of new tyres may vary, according to the type and make of tyre and the tread pattern.

Replacing tyres

- Where possible, always replace both wheels on an axle (both wheels on the front axle or both wheels on the rear axle) »» .
- Old tyres should only be replaced by SEAT approved tyres for the vehicle in question, and in accordance with the maximum permitted size, diameter, load and speed capacity.
- If replacing tyres, make sure the new ones have an emergency ride system (Conti-Seal/Run flat). Otherwise, we recommend carrying a tyre mobility system.
- Never use tyres which are larger than SEAT approved tyres. If the tyres are too big, they may knock or rub against the chassis or other components, resulting in damage.

WARNING

New tyres do not give maximum grip and will not have reached their maximum braking capacity to start with, and therefore need running in.

- To prevent accidents and major damage, extreme caution should be taken for the first 500 km (310 miles).

⚠ WARNING

There should be adequate space between the tyres and the vehicle in accordance with the vehicle design. If this is not the case, the tyres may rub against parts of the running gear, chassis or brake lines, leading to faults in the brake system or to tread detachment, and the risk of burst tyres.

- The true tyre dimension should not be greater than the dimensions of tyres manufactured and approved by SEAT and should not rub against parts of the vehicle.

i Note

- Although tyres may be shown as being the same size, the true dimensions of different types of tyre may vary with respect to the nominal size, or tread patterns may be different.
- If you use tyres that are approved by SEAT, you can be sure that the true tyre dimensions will be correct for your vehicle. For other tyre models, the tyre vendor should provide the manufacturer's certificate with the tyre, indicating that this type of tyre is suitable for your vehicle. This certificate should always be carried with the vehicle.

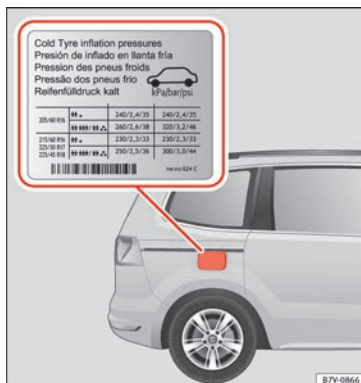
Tyre pressure

Fig. 252 Position of tyre pressure specification plate

The correct tyre pressures for tyres fitted at the factory is shown on a label and is valid for summer and winter tyres. This label **»» Fig. 252** is either on the driver door strut or inside the fuel tank flap.

Under-inflation or over-inflation will reduce the life of the tyres considerably and also impair the car's handling **»» ⚠**. It is essential to maintain the correct tyre pressures, especially if driving at **high speeds**. Incorrect tyre pressure causes premature wear and could cause tyre blow-out.

The pressure should therefore be checked at least once a month and before starting a journey.

As a general rule, the pressures given are for **cold tyres**. When the tyres are hot, the pressures are greater.

Never deflate a hot tyre in order to obtain the required pressure. This could result in very low tyre pressures which may lead to sudden blow-outs.

Checking tyre pressures

Tyre pressures should only be checked when the vehicle has not been driven for more than a few kilometres (miles) at low speeds in the past three hours.

- The tyre pressures should be checked regularly, and only when the tyres are cold. Always check all the tyres. Tyre pressures should be checked more often in colder regions, and only when the vehicle has not been driven recently. Always use a correctly-operating tyre gauge.
- Adjust tyre pressures to the loads carried in the vehicle.
- After checking the pressure, always replace the valve caps, and where applicable, observe the instructions given for adjusting the tyre control system **»» page 234.**

⚠ WARNING

If tyre pressures are too high or too low, the tyre may deflate or burst suddenly while driving. This could result in a serious accident.

- If the tyre pressure is too low, they could overheat, resulting in tread detachment or even burst tyres.
- When driving at high speeds and/or fully loaded, the tyre could suddenly overheat, burst or be subject to tread detachment, with the resultant loss of control of the vehicle.
- Tyre pressures which are too high or too low reduce the service life of the tyre, affecting the vehicle's performance.
- Tyre pressures should be checked regularly, at least once a month and before long journeys.
- Adjust the pressures of all the tyres to the vehicle load.
- Never deflate excess pressure from hot tyres.

ⓘ CAUTION

- Take care not to tilt the manometer when placing it on the valve. Otherwise, the valve may be damaged.
- If tyre valves are not protected by caps, or if the caps are not screwed on correctly, they may become damaged. Check that the caps are identical to the standard caps and have been correctly tightened.

♻ For the sake of the environment

Under-inflated tyres will increase fuel consumption.

ⓘ Note

When checking tyre pressures, please observe the instructions for the tyre control system »» page 234.

Wear indicator depth profile

Fig. 253 Tyre tread: tread wear indicators

Tread depth

Certain driving conditions require a deeper tread, as well as needing the tread to be approximately the same on the front and rear tyres. This is particularly important when driving in winter, in cold temperatures and on wet roads »» ⚠.

The minimum tread depth required by law in the majority of cases is 1.6 mm (1/16 of an inch), measured in the tread grooves next to the tread wear indicators. Observe legal requirements in each country.

Winter tyres lose much of their performance when their tread has worn to 4 mm (5/32 inch).

The tread depth of new tyres may vary, according to the type and make of tyre and the tread pattern.

Wear indicators on the tyre

The original tyres on your vehicle have 1.6 mm (1/16 inch) high »» **Fig. 253** tread wear indicators running across the tread. A number of these indicators are equally spaced around the tyre tread. Certain marks on the tyre walls (e.g. the letters "TWI" or other symbols) indicate the position of the wear indicators.

Tread wear indicators indicate if a tyre is worn. They must always be replaced before the tyre tread has worn to the level of the indicator.

⚠ WARNING

Driving with worn tyres is dangerous, and may lead to loss of control of the vehicle with serious consequences.

- Tyres must be replaced before the wear indicators are at the same level as the tread pattern.
- Worn tyres have significantly reduced grip, especially on wet surfaces, increasing the risk of “aquaplaning”.
- Worn tyres make control of the vehicle more difficult in normal or difficult driving conditions, increasing the braking distance and the risk of skidding.

Tyre damage

Damage to wheels and tyres is often invisible to the naked eye. If you notice unusual **vibration** or the car **pulling to one side**, this may indicate that one of the tyres is damaged »» ⚠.

- Slow down immediately if you think you have a damaged wheel.
- Check the wheels and tyres for damage.
- If tyres are worn, stop driving and seek qualified assistance.
- If there is no visible exterior damage, drive slowly and carefully to the nearest specialised workshop and have the vehicle checked.

Foreign bodies in the tyre

- Do not remove foreign bodies if they have penetrated through the tyre wall!

- If the vehicle comes with a tyre mobility system, where necessary seal the damaged tyre as shown in section »» page 86. Use a specialised workshop for repair or replacement. SEAT recommends visiting a SEAT dealership for this.

The sealant at the lower part of the tyre tread wraps around the foreign body and provisionally seals the tyre.

Tyre wear

The wear of tyres depends on a number of factors, for example:

- Driving style.
- Unbalanced wheels.
- Running gear settings.

Driving style: Driving round bends quickly or sudden acceleration or braking speed accelerates tyre wear. When the driving style is normal, if the tyres wear too quickly, have the running gear settings checked at a specialised workshop.

Wheel run-out: The wheels on new vehicles are balanced. However, certain circumstances may lead to imbalance (run-out), which is detected as vibrations in the steering wheel. Run-out leads to wear of the steering and suspension. In the event of run out, the wheels should be balanced again. When a new wheel is fitted, it should be balanced again.

Running gear settings: an incorrectly positioned running gear increases the wear of tyres and affects your safety while driving. If tyres wear too quickly, have the wheel alignment checked at a specialised workshop.

⚠ WARNING

If you notice unusual vibration or the car pulls to one side while driving, this may indicate that one of the tyres is damaged.

- Reduce speed immediately and stop, while observing the highway code.
- Check the wheels and tyres for damage.
- Never carry on driving on worn tyres or wheels. Request qualified assistance immediately.
- If there is no visible exterior damage, drive slowly and carefully to the nearest specialised workshop and have the vehicle checked.

Tyre code

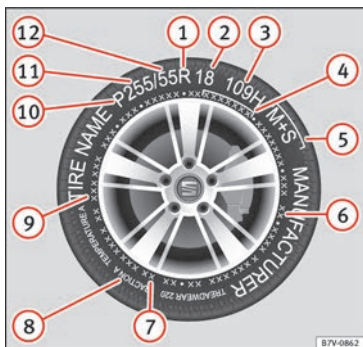


Fig. 254 Universal code on tyres

- ① Radial
- ② Rim diameter code
- ③ Load index & speed rating
- ④ DOT tyre identification number
- ⑤ Severe snow conditions
- ⑥ Tyre ply composition and materials used
- ⑦ Max. load rating
- ⑧ Treadwear, traction and temperature grades
- ⑨ Max. permissible inflation pressure
- ⑩ Passenger car tyre
- ⑪ Nominal width of tyre in millimetres

⑫ Ratio of height to width (aspect ratio)

Tyre code (example): Meaning

P215 / 55 R 16: Size:

P	Passenger vehicle code.
215	Nominal width between walls, in mm.
55	Height/width ratio in %
R	Tyre type (R indicates "Radial").
16	Rim diameter in inches
91 V	Load index » page 295 and speed rating » page 295.
XL	Reinforced tyres ("Reinforced").
M+S or M/S	Winter tyres (mud and snow tyres) » page 295.
SSR or DSST, Eufonia, RFT, ROF, RSC, ZP, Conti-Seal	Specific manufacturer codes for run-flat tyre codes.
RADIAL TUBELESS	Radial tyre without inner tube.
E4 ...	E-mark certifying tyre complies with international legislation followed by a number denoting the country granting the authorisation. The authorisation number (several digits) is shown below.

Tyre code (example): Meaning

DOT BT RA TY5 1716: Tyre identification number (TIN^a, maybe only on exterior wall of the wheel) and date of manufacture.

DOT	The tyre complies with the legal requirements of the US Department of Transport, responsible for tyre safety regulations.
BT	Place of manufacture code.
RA	Information about manufacturer and tyre size.
TY5	Manufacturer's tyre specifications.
1716	Date of manufacture: week 17 of 2016.
TWI	This identifies the position of the Tread Wear Indicator » page 292.
MAX LOAD 615 KG (1356 LBS)	US load rating, indicating maximum permitted load per tyre.
MAX INFLATION 350 KPA (51 PSI)	US limit, indicating maximum permitted tyre pressure.
SIDEWALL 1 PLY RAYON	Information about tyre wall components: 1 layer of rayon (artificial silk).
TREAD 4 PLYES 1 RAYON + 2 STEEL + 1 NYLON	Information about tread components: In the example, there are 4 layers below the tread: 1 layer of rayon (artificial silk), 2 layers of steel reinforcement and 1 layer of nylon.

Tyre code (example): Meaning

Information for the end consumer concerning the comparative values of the established base tyres (standardised test procedures):

TREADWEAR 280	Relative service life of the tyre, with respect to specific US standard test.
TRACTION AA	Braking capacity of tyre on wet surface (AA, A, B or C).
TEMPERATURE A	Tyre temperature resistance at higher test speeds (A, B or C).

If there are different letters, they are specific codes of the tyre manufacturer or specific national codes.

^{a)} The letters TIN refer to the tyre serial number.

Tyres with directional tread patterns

Tyres with directional tread pattern have been designed to operate best when rotating in only one direction. An arrow on the tyre sidewall indicates the direction of rotation on tyres with directional tread. Always observe the direction of rotation indicated when mounting the wheel. This guarantees optimum grip and helps to avoid aquaplaning, grip, noise and wear.

Tyre load rating

The load rating code indicates the maximum load in kilogrammes each wheel can carry (load capacity).

91 615 kg (1,356 pounds)

93 650 kg (1,433 pounds)

95 690 kg (1,521 pounds)

97 730 kg (1,609 pounds)

99 775 kg (1,709 pounds)

Speed rating

The speed rating indicates the maximum speed permitted for the tyres.

P	max. 150 km/h (93 mph)
Q	max. 160 km/h (99 mph)
R	max. 170 km/h (106 mph)
S	max. 180 km/h (112 mph)
T	max. 190 km/h (118 mph)
U	max. 200 km/h (124 mph)
H	max. 210 km/h (130 mph)
V	max. 240 km/h (149 mph)
Z	max. 240 km/h (149 mph)
W	max. 270 km/h (168 mph)
Y	max. 300 km/h (186 mph)

Some manufacturers use the letters “ZR” for tyres with a maximum authorised speed above 240 km/h (149 mph).

Winter service**Winter tyres***


In winter conditions winter tyres will considerably improve the vehicle's handling. The design of summer tyres (width, rubber compound, tread pattern) gives less grip on ice and snow. Winter tyres also improve the vehicle braking performance, reducing the braking distance in winter weather. SEAT recommend that winter tyres be fitted to the vehicle at temperatures below +7°C (+45°F).

The performance of winter tyres is much reduced if the **tyre tread** is worn below 4 mm (1/16 inch). The **age** of the tyre is another factor affecting performance, regardless of the depth of the tyre tread.

Please observe the following when using winter tyres:


- Observe legal requirements in each country.
- Winter tyres must be fitted on all four wheels.
- Only use winter tyres in wintery weather conditions.
- Only use winter tyres of the size authorised for the vehicle.
- Only use radial winter tyres of the same type, size (rolling circumference) and tread pattern.



- Adjust speeds to within the limits indicated (code letter on tyre) » » .

Speed limit

A code letter indicating the speed limit is stamped on all winter tyres » » page 295.

In some vehicles, it is possible to set a speed warning in the **MFD (multifunction display)** menu on the instrument panel » »  page 27.

If you use **V-rated tyres** the speed limits and tyre pressure will be determined by engine size. Please ask your technical service centre for further information on the maximum permitted speed and the required pressures for the tyres.

All-wheel drive*

Thanks to its all-wheel drive, your car will have plenty of traction in winter conditions, even with the standard tyres. Nevertheless, SEAT still recommend that winter tyres or all-season tyres should be fitted *on all four wheels* when winter road conditions are expected, mainly because this will give a better *braking response*.

Please observe all instructions and warnings when using **snow chains** » »  page 50.

WARNING

Although winter tyres help to make driving safer in the winter, you should not take unnecessary risks.

- Adjust your speed and driving style to visibility, road, traffic and weather conditions.
- Never exceed the maximum permitted speed or loads specified for the type of winter tyre fitted on your vehicle.

For the sake of the environment

When winter is over, change back to summer tyres when you have the time. In temperatures above +7°C (+45°F), performance will be improved if summer tyres are used. Fuel consumption, wear and noises while driving will all be reduced.

Note

- If the vehicle is fitted with a tyre control system, this should be “reprogrammed” whenever a tyre is changed » » page 236.
- Please ask at a technical service centre for information about the permitted sizes for winter tyres.

Technical data

Technical features

Important information

Important

The information in the vehicle documentation always takes precedence over the information in this Instruction Manual.

All technical specifications provided in this documentation are valid for the standard model in Spain. The vehicle data card included in the Maintenance Programme or the vehicle registration documents shows which engine is installed in the vehicle.

The figures may be different depending whether additional equipment is fitted, for different models, for special vehicles and for other countries.

Abbreviations used in the Technical Specifications section

kW	Kilowatt, engine power measurement.
PS	Pferdestärke (horsepower), formerly used to denote engine power.
rpm	Revolutions per minute - engine speed.
Nm	Newton metres, unit of engine torque.
CZ	Cetane number, indication of the diesel combustion power.
RON	Research octane number, indication of the knock resistance of petrol.

Vehicle identification data



Fig. 255 Vehicle identification number.

Vehicle identification number

The vehicle identification number (chassis number) can be read from outside the vehicle

through a viewer in the windscreen
 » **Fig. 255**. This viewer is located in the lower part of the windscreen. The vehicle identification number (chassis number) is also stamped on the right water drain channel. The water drain channel is located between the suspension tower and the wing. Open the bonnet to read the vehicle identification number
 ⚠ » **page 271**.

Vehicle data plate

The vehicle data plate is attached to the luggage compartment, and contains the following information:

- Vehicle identification number (chassis number).
- Vehicle type, engine power, gearbox type.
- Engine and gearbox code, paint number, interior equipment.
- Optional extras, PR numbers.

These data are also provided in the Maintenance Programme.

Type plate

The type plate is visible when the driver door is opened, on the lower part of the strut. Vehicles for certain export countries do not have a type plate.

The manufacturer's type plate contains the following data:

- Gross vehicle weight
- Maximum authorised weight of vehicle and trailer
- Maximum gross front axle weight
- Maximum rear axle weight

Fuel consumption

Approved consumption values are derived from measurements performed or supervised by certified EU laboratories, according to the legislation in force at the time (for more information, see the Publications Office of the European Union on the EUR-Lex website: © European Union, <http://eur-lex.europa.eu/>) and apply to the specified vehicle characteristics.

The values relating to fuel consumption and CO₂ emissions can be found in the documentation provided to the purchaser of the vehicle at the time of purchase.

Fuel consumption and CO₂ emissions depend on the equipment/features of each individual vehicle, as well as on the driving style, road conditions, traffic conditions, environmental conditions, load or number of passengers.

Note

In practice, and considering all the factors mentioned here, consumption values can differ from those calculated in the current European regulations.

Weights

Kerb weight refers to the basic model with a fuel tank filled to 90% capacity and without optional extras. The figure quoted includes 75 kg to allow for the weight of the driver.

Special versions, optional equipment fittings or retro-fitting accessories will increase the weight of the vehicle »» ⚠.

⚠ WARNING

- **Please note that the centre of gravity may shift when transporting heavy objects; this may affect vehicle handling and lead to an accident. Always adjust your speed and driving style to suit road conditions and requirements.**
- **Never exceed the gross axle weight rating or the gross vehicle weight rating. If the permissible axle load or the permissible total weight is exceeded, the driving characteristics of the vehicle may change, leading to accidents, injuries and damage to the vehicle.**

Towing a trailer

Trailer weights

Trailer weight

The trailer weights and drawbar loads approved are selected in intensive trials according to precisely defined criteria. The ap-

proved trailer weights are valid for vehicles in the EU for maximum speeds of 80 km/h (50 mph) (in certain circumstances up to 100 km/h (62 mph)). The figures may be different in other countries. All data in the official vehicle documentation takes precedence over these data at all times »» ⚠.

Drawbar loads

The *maximum* permitted drawbar load on the ball joint of the towing bracket must not exceed **100 kg**.

In the interest of road safety, we recommend that you always tow approaching the maximum drawbar load. The response of the trailer on the road will be poor, if the drawbar load is too small.

If the maximum permissible drawbar load cannot be met (e.g. with small, empty and light-weight single axle trailers or tandem axle trailers with a wheelbase of less than 1 metre), a minimum of 4% of the actual trailer weight is legally required for the drawbar load.

⚠ WARNING

- **For safety reasons, do not exceed the 80 km/h (50 mph) limit. This is also valid in countries where higher speeds are permitted.**
- **Never exceed the maximum trailer weights or the drawbar load. If the permissible axle**

load or the permissible total weight is exceeded, the driving characteristics of the vehicle may change, leading to accidents, injuries and damage to the vehicle.

Wheels

Tyre pressure, snow chains and wheel bolts

Tyre pressure

The sticker with the tyre pressure values can be found on the inside of the fuel tank flap. The tyre pressure values given there are for *cold* tyres. The slightly raised pressures of warm tyres must not be reduced. » » ⚠

The pressure for winter tyres is 0.2 bar (2.9 psi / 20 kPa) higher than that of summer tyres.

Snow chains

Snow chains may be fitted only to the *front wheels*.

Consult section » »  page 50, **Snow chains**.

Wheel bolts

After the wheels have been changed, the **tightening torque** of the wheel bolts should be checked as soon as possible with a torque

wrench » » ⚠. The tightening torque for steel and alloy wheels is **140 Nm**.

⚠ WARNING

- Check the tyre pressure at least once per month. Checking the tyre pressure is very important. If the tyre pressure is too high or too low, there is an increased danger of accidents - particularly at high speeds.
- If the tightening torque of the wheel bolts is too low, they could loosen while the vehicle is in motion. Risk of accident! If the tightening torque is too high, the wheel bolts and threads can be damaged.

Note

We recommend that you ask your Technical Service for information about appropriate wheel, tyre and snow chain size.

Engine data

Petrol engine 1.4 110 kW (150 PS)

Power output in kW (PS) at rpm	Maximum torque (Nm at rpm)	No. of cylinders/displacement (cm ³)	Fuel
110 (150)/5,000-6,000	250/1,500-3,500	4/1,395	Super 95 RON

	Manual		Automatic	
	5 seats	7 seats	5 seats	7 seats
Top speed (km/h)	200 (VI)		198 (VI)	
Acceleration from 0-80 km/h (seconds)	6.7		6.7	
Acceleration from 0-100 km/h (seconds)	9.9		9.9	
Maximum authorised weight (in kg)	2,300	2,420	2,310	2,430
Weight in running order (with driver) (in kg)	1,703	1,755	1,717	1,768
Maximum authorised weight on front axle (en kg)	1,190	1,190	1,200	1,200
Maximum authorised weight on rear axle (en kg)	1,160	1,280	1,160	1,280
Permitted roof load (in kg)	100		100	
Maximum weight trailer without brakes (in kg)	750		750	
Weight of trailer with brakes on gradients up to 8% (in kg)	2,000		2,000	
Weight of trailer with brakes on gradients up to 12% (in kg)	1,800		1,800	

Technical features

Petrol engine 2.0 162 kW (220 PS)

Power output in kW (PS) at rpm	Maximum torque (Nm at rpm)	No. of cylinders/displacement (cm ³)	Fuel
162 (220)/4,500-6,200	350/1,500-4,400	4/1,984	Super 95 RON

	Automatic	
	5 seats	7 seats
Top speed (km/h)	226 (V)	
Acceleration from 0-80 km/h (seconds)	5.4	
Acceleration from 0-100 km/h (seconds)	7.8	
Maximum authorised weight (in kg)	2,360	2,490
Weight in running order (with driver) (in kg)	1,790	1,838
Maximum authorised weight on front axle (en kg)	1,250	1,250
Maximum authorised weight on rear axle (en kg)	1,160	1,290
Permitted roof load (in kg)	100	
Maximum weight trailer without brakes (in kg)	750	
Weight of trailer with brakes on gradients up to 8% (in kg)	2,300	2,400
Weight of trailer with brakes on gradients up to 12% (in kg)	2,200	

Technical data

Diesel engine 2.0 85 kW (115 PS)

Power output in kW (PS) at rpm	Maximum torque (Nm at rpm)	No. of cylinders/displacement (cm ³)	Fuel
85 (115)/3,500	280/1,750-3,000	4/1,968	Diesel according to standard EN 590, min. 51 CZ

	5 seats	7 seats
Top speed (km/h)	184 (VI)	
Acceleration from 0-80 km/h (seconds)	8.4	
Acceleration from 0-100 km/h (seconds)	12.6	
Maximum authorised weight (in kg)	2,390	2,520
Weight in running order (with driver) (in kg)	1,772	1,822
Maximum authorised weight on front axle (en kg)	1,260	1,260
Maximum authorised weight on rear axle (en kg)	1,180	1,310
Permitted roof load (in kg)	100	
Maximum weight trailer without brakes (in kg)	750	
Weight of trailer with brakes on gradients up to 8% (in kg)	2,200	
Weight of trailer with brakes on gradients up to 12% (in kg)	2,000	

Technical features

Diesel engine 2.0 110 kW (150 PS)

Power output in kW (PS) at rpm	Maximum torque (Nm at rpm)	No. of cylinders/displacement (cm ³)	Fuel
110 (150)/3,500	340/1,750-3,000	4/1,968	Diesel according to standard EN 590, min. 51 CZ

	Manual		Automatic		All-wheel drive	
	5 seats	7 seats	5 seats	7 seats	5 seats	7 seats
Top speed (km/h)	200 (VI)		198 (VI)		198 (VI)	
Acceleration from 0-80 km/h (seconds)	7.3		7.3		7.1	
Acceleration from 0-100 km/h (seconds)	10.3		10.3		10.6	
Maximum authorised weight (in kg)	2,390	2,520	2,410	2,540	2,560	2,590
Weight in running order (with driver) (in kg)	1,772	1,882	1,793	1,843	1,891	1,952
Maximum authorised weight on front axle (en kg)	1,260	1,260	1,280	1,280	1,320	1,320
Maximum authorised weight on rear axle (en kg)	1,180	1,310	1,180	1,310	1,290	1,320
Permitted roof load (in kg)	100		100		100	
Maximum weight trailer without brakes (in kg)	750		750		750	
Weight of trailer with brakes on gradients up to 8% (in kg)	2,300	2,400	2,300	2,400	2,400	
Weight of trailer with brakes on gradients up to 12% (in kg)	2,200		2,200		2,400	

Technical data

Diesel engine 2.0 135 kW (184 PS)

Power output in kW (PS) at rpm	Maximum torque (Nm at rpm)	No. of cylinders/displacement (cm ³)	Fuel
135 (184)/3,500-4,000	380/1,750-3,000	4/1,968	Diesel according to standard EN 590, min. 51 CZ

	Manual		Automatic		Automatic all-wheel drive	
	5 seats	7 seats	5 seats	7 seats	5 seats	7 seats
Top speed (km/h)	215 (VI)		213 (VI)		211 (VII)	
Acceleration from 0-80 km/h (seconds)	6.4		6.4		5.7	
Acceleration from 0-100 km/h (seconds)	8.9		8.9		8.9	
Maximum authorised weight (in kg)	2,400	2,550	2,400	2,550	2,560	2,590
Weight in running order (with driver) (in kg)	1,800	1,841	1,804	1,845	1,923	1,974
Maximum authorised weight on front axle (en kg)	1,290	1,290	1,290	1,290	1,320	1,320
Maximum authorised weight on rear axle (en kg)	1,160	1,310	1,160	1,310	1,290	1,320
Permitted roof load (in kg)	100		100		100	
Maximum weight trailer without brakes (in kg)	750		750		750	
Weight of trailer with brakes on gradients up to 8% (in kg)	2,400		2,400		2,400	
Weight of trailer with brakes on gradients up to 12% (in kg)	2,200		2,200		2,400	

Dimensions

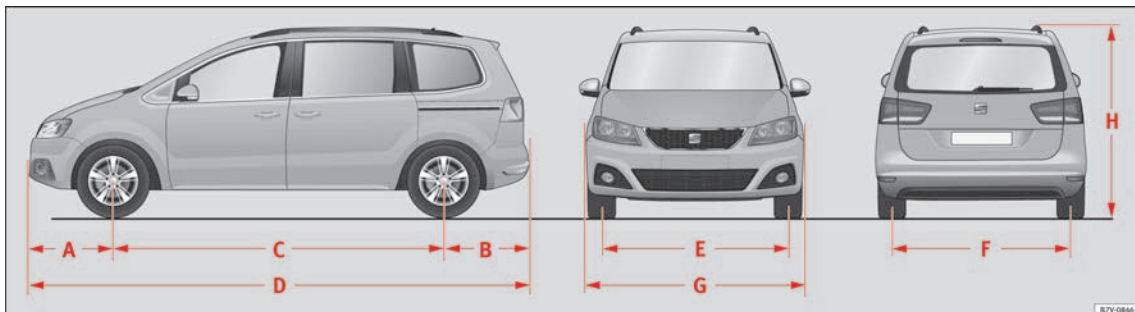


Fig. 256 Dimensions.

		ALHAMBRA
A/B	Front and rear projection (mm)	968/966
C	Wheelbase (mm)	2,919
D	Length (mm)	4,854
E/F	Front/rear ^{a)} track width (mm)	1,569/1,617
G	Width (mm)	1,904
H	Height at kerb weight (mm)	1,720
	Turning radius (m)	11.9

^{a)} This data will change depending on the type of wheel rim.

Index

A

- Abroad
 - extended stay abroad with your vehicle 263
 - sale of vehicle 263
- ABS
 - see Anti-lock brake system 205
- Accessories 247
- Acoustic alarm
 - control and warning lamps 34
 - seat belt unfastened 63
- Adaptive headlights
 - dynamic 132
- AdBlue
 - control and warning lamps 269
 - information 269
 - minimum quantity for a refill 269
 - refilling 270
 - specifications 270
 - tank filling capacity 268
- Additional heater
 - see "Auxiliary heater" 180
- Adjusting
 - folding the backrest of the front passenger seat 151
 - front seats 143
 - lights 135
 - rear head restraints 17, 144
 - seats 58
 - seat with position memory 148
- Adjusting the head restraints
 - rear head restraints 17, 144
- Adjusting the seats
 - front seats 143
 - rear seats 143
- AFS 132
- Air-conditioning
 - malfunctions 177
- Airbag covers 19
- Airbags
 - see Airbag system 20
- Airbag system 19, 69
 - activation 71
 - cleaning dash panel 262
 - control lamp 73
 - description 70
 - front airbags 19, 72
 - functioning 71
 - head-protection airbag 21
 - knee airbag 20
 - locking the vehicle after deployment 115
 - repairs 249
 - side airbags 21
 - use of child seats 20
 - Use of child seats 74
 - vehicle care 262
- Air conditioning 176
 - air recirculation 179
 - air vents 178
 - climatronic 37, 176
 - controls 37, 176
 - electronic manual air conditioning 176
 - indirect ventilation 178
 - rear seats 177
 - special features 178
 - user instructions 177
- Air recirculation 179
- Air vents 178
- Alcantara 260
- All-wheel drive
 - snow chains 50
 - winter tyres 296
- Ambient lighting 136
- Anodized surfaces 257
- Antenna 249, 263
- Anti-freeze 41
- Anti-lock brake system 205
- Anti-lock system 206
- Anti-puncture 45, 86
 - Anti-puncture kit 45, 86
 - cases where it should not be used 86
- Anti-puncture set 86
- Anti-theft alarm 119
 - false alarms 121
 - trailer 241
- Anti-theft alarm system
 - anti-tow system 120
 - vehicle interior monitoring 120
- Anti-theft security system 119
- Anti-tow system 120
- Anti-trap function
 - panoramic sunroof 130
 - sun blind 130
- Antifreeze 41, 279
- Armrests 152
- Ashtray 172
- ASR
 - see Brake assist system 206, 207
 - switching on and off 207
 - see also Traction control system 205
- Assistance call 111
- Assistance systems
 - adaptive headlights 132
 - auto Hold 208
 - blind spot detector (BSD) with rear cross traffic alert (RCTA) 225
 - brake assist system (BAS) 206
 - cruise control system 221
 - dynamic chassis control (DCC) 233
 - electronic differential lock system (EDS) 206

- electronic drive torque management (XDS) . . . 206
 - lane Assist 222
 - lane assist system 222
 - Launch-Control programme 197
 - optical parking system 213
 - park Assist 214
 - park assist system 214
 - parking assistance 212
 - parking distance warning system 212
 - rear assist 217
 - rear cross traffic alert (RCTA) 225
 - rear View Camera 217
 - sign Assist 230
 - start-Stop 209
 - start assistance 208
 - tiredness detection 232
 - traction control when accelerating (ASR) .206, 207
 - traffic signal detection 230
 - tyre monitoring indicator 236
 - Assisted starting 52
 - Auto Hold 208
 - Automatic belt retractor 68
 - Automatic car wash
 - switching Auto Hold off 209
 - switching the start assist off 209
 - Automatic dipped beam control 132
 - Automatic gearbox 194
 - driving tips 196
 - emergency release 36
 - ignition key removal lock 185
 - kick-down 196
 - malfunction 196, 197
 - AUX-IN 110
 - Auxiliary heater 180
 - automatic off 266
 - operating instructions 183
 - programming 182
 - remote control 181
 - remote control range 181
 - remote control: replacing the battery 181
 - special features 180
 - switching off 180
 - switching on 180
 - things to note 183
 - Auxiliary heater remote control
 - auxiliary heater 181
 - replacing the battery 181
- B**
- BAS
 - see Brake assist system 206
 - Battery
 - changing in the vehicle key 113
 - Before setting off 57
 - Belt height adjustment 68
 - Belt tension device
 - service and disposal 69
 - Belt tensioner 68
 - Belt tension limiter 68
 - Belt tightening 68
 - Bicycle carrier
 - fitting on the tow hitch ball 240
 - maximum load 240
 - Biodiesel 268
 - Blind spot detector (BSD) 225
 - control lamps 225
 - driving situations 228
 - indication in the external rear view mirror 226
 - malfunction 225
 - operating 226
 - towing 230
 - Bonnet 13
 - opening and closing 273
 - Bottle holders 171
 - Brake
 - brake servo 192
 - emergency braking function 190
 - Brake assist system 205
 - Brake fluid 42
 - specification 281
 - Brakes 188
 - brake assist system 205
 - brake fluid 281
 - brake fluid level 282
 - brake pads 191
 - changing the brake fluid 282
 - control and warning lamps 188
 - electronic parking brake 190
 - running in new brake pads 191
 - Brake servo 192, 205
 - Brake system 205
 - fault 192
 - Braking
 - brake assist system 205
 - BSD
 - see Blind spot detector 225
 - Bulb malfunction
 - see Changing bulbs 92
- C**
- Capacities 40
 - windshield wiper fluid tank 283
 - Card compartment 168
 - Caring for paintwork 256
 - Caring for the vehicle
 - exterior 253
 - Catalytic converter 203
 - control and warning lamps 202
 - malfunction 203
 - CCS 221
 - see cruise control 33

- CD changer 166, 171
- Central locking 114
 - anti-theft alarm 119
 - keyless Access 117
 - manual locking 11
 - opening doors individually 115
- Central locking system
 - after airbag deployment 115
 - description 115
 - remote control key 115
- Centre armrest 152
- Cetane number (diesel fuel) 268
- Changing a bulb
 - control lamp 92
- Changing a wheel 46, 85
 - subsequent work 50
 - wheel bolts 47
- Changing bulbs 92
 - body 96
 - front bumper 95
 - halogen headlights 93
 - number plate light 97
 - rear lid 95
 - rear lights 95, 96
 - xenon headlights 94
- Changing gear
 - control and warning lamps 193
- Changing the blades 88
- Changing windscreen wipers 55
- Charging the battery 52
- Checking
 - tyre pressures 291
- Checking fluid levels 274
- Child safety 75
- Child seat
 - deactivating the passenger front airbag 20
 - integrated child seat 79
 - in the passenger seat 77
 - ISOFIX system 78
 - mounting systems 23
 - on rear seats 78
 - regulations 77
 - safety instructions 22, 76
 - securing with seat belt 23
 - Top Tether system 24
 - transporting children in the vehicle 76
 - weight categories 77
- Child seats 22, 76
 - disabling the front passenger front airbag 74
- Chrome parts 257
- Cigarette lighter 172, 173
- Cleaning 253
 - adhesive sheets 255
 - compartments 262
 - dash panel 262
 - engine compartment 258
 - fabrics 259
 - folding the rear view mirrors 142
 - natural leather 261
 - seat belts 262
 - synthetic leather 261
 - textile covers 260
 - trims 260
 - washing the vehicle 253
 - washing the vehicle with high pressure cleaners 255
 - wheels 257
 - windows 255
- Cleaning the vehicle
 - high pressure cleaners 255
- Climatronic 37, 176
- Close
 - bonnet 13
- Closing 112
 - bonnet 13
 - electric windows 13
 - luggage compartment 12, 125
 - panoramic sunroof 14
- Clothes hook 170
- Code number 46, 84
- Combined weight rating 245
- Coming Home 133
- Compartment for (sun)glasses 166
- Compartments
 - centre console 167
 - front central armrest 168
- Compass 105
- Connectors
 - faults 175
- Control and warning lamps
 - ABS 188
 - adBlue 269
 - airbag system 73
 - blind spot detector (BSD) 225
 - brake system 188
 - catalytic converter 202
 - changing bulbs 92
 - changing gear 193
 - coolant 278
 - cruise control system (CCS) 221
 - door 121
 - emission control system 202
 - engine management 202
 - engine oil sensor 275
 - ESC 188
 - for the seat belt 63
 - fuel level 266
 - generator 284
 - indication of break pad wear 188
 - key 113

- lane assist system 223
 lights 130, 131
 locking the steering column 198
 overview 34, 107
 rear cross traffic alert (RCTA) 225
 rear lid 125
 refuelling 266
 remote control 181
 tyre monitoring indicator 235
 vehicle battery 284
 windscreen washer fluid level 137
- Control of function
 rain sensor 139
- Controls for the windows 13, 127
- Controls on the steering wheel
 operating the audio system and telephone .. 108
- Control units 250
 reprogramming 250
- Convenience closing
 windows 127
- Convenience functions
 reprogramming 250
- Convenience opening
 windows 127
- Convenient entry function for the third row of
 seats 149
- Cooling system
 checking the coolant 277
 topping up with coolant 277
- Cornering lights
 see "Static cornering lights" 132
 static 132
- Correct position 58
 driver 58
- Counter steering assistance system 199
- Crossing through water
 salt water 205
- Cruise control 221
 Cruise Control System (CCS) 33, 221
 control lamp 221
 operations 221
 warning lamp 221
- D**
- Dangers of not using a seat belt 64
- Dash panel 101
 airbag system 262
- Data plate 297
- Data registry 250
- Data storage during the journey 250
- Daytime running lights 132
- DCC
 see Dynamic chassis control 233
- De-icing the locks 258
- Diagnostics connector 251
- Diesel
 refuelling 268
 Diesel particulate filter 203
 malfunction 203
 recommended gear 197
- Differential lock
 see Brake assist system 206
- Digital clock 102
- Dimensions 305
- Directional tread pattern
 tyres 50
- Disconnecting devices 286
- Disconnecting the passenger front airbag 20
- Display 102, 103
- Disposal
 belt tension device 69
- Door 121
 childproof lock 123
 emergency locking and unlocking 10
 opening and closing 10
 warning lamp 121
- Door handle 10
- Door lock 10
- Door lock cylinder 10
- Door release lever 101
- Drawbar load 237
 loading the trailer 242
- Drawers 169
- Drink holder
 central console 172
- Drink holders 171
 rear 172
- Driving
 automatic gearbox 196
 cross country 57
 data storage 250
 driving abroad 204
 driving through water 204
 economical 200
 fuel gauge 266
 fuel level too low 266
 parking downhill 191
 parking uphill 191
 safe 57
 towing 90
 trailer 243
 undercarriage guard 57
 with a trailer 237
- Driving abroad
 headlights 135
- Driving in winter
 fuel consumption 202
 snow chains 50
 tread depth 292
 tyre pressures 291
 windscreen washer reservoir 256

- Driving through water 204
- Driving tips
for a loaded vehicle 152
- Driving with a trailer
extinguisher 239
technical requirements 238
- Duplicate keys 112
- Dynamic chassis control (DCC)
control 233
operation 233
- Dynamic Chassis Control (DCC) 233
fault 234
- Dynamic headlight range control 135
- E**
- E10
see Ethanol (fuel) 267
- EDL
see Electronic differential lock 205
- EDS
see Brake assist system 206
- Electrical devices 173, 174, 183, 242
- Electrical socket
trailer 241
- Electric child safety lock 123
- Electric sliding door
opening and closing 122
rollback anti-trap function 123
- Electric windows 13
see Windows 127
- Electronic differential lock 205
- Electronic differential lock system (EDS) 206
- Electronic drive torque management (XDS) 206
- Electronic immobiliser 187
operating fault 183
- Electronic Stability Control (ESC) 205
- Emergencies 83
bulbs 44
changing a wheel 46
emergency towing of the vehicle 51
extinguishers 83
first aid kit 83
fuses 43
hazard warning lights 134
jump leads 52
puncture 45
replacing a blown fuse 44
vehicle tool kit 83
warning triangle 83
- Emergency braking function 190
- Emergency locking and unlocking 90
driver door 10
panoramic sliding sunroof 15
passenger side door 11
rear lid 12
- Emergency unlocking
doors 10
rear lid 12
- Emission control system
control and warning lamps 202
- Emissions data 298
- Engine
assisted starting 52
noises 187
running in 199
- Engine and ignition 183
12 volt power sockets 173
ignition lock 184
immobiliser 187
pre-heating 186
starting the engine 184, 186
starting the engine with Keyless Access 185
- stopping the engine 187
unauthorised vehicle key 184
- Engine bonnet 271
- Engine compartment 13, 271
battery 42, 283
brake fluid 42, 281
coolant 41, 277
engine oil 40, 274, 277
opening and closing 273
windscreen washer reservoir 42, 283
- Engine coolant 41
checking the level 277, 280
control and warning lamps 278
G12 plus-plus 41, 279
G12 plus-plus 41
G13 41, 279
specifications 41, 279
tank filler neck 280
temperature indicator 278
topping-up 280
- Engine data 300
- Engine management 202
control lamp 202
- Engine oil 40, 274
checking oil level 276
consumption 276, 277
control and warning lamps 275
dipstick 276
specifications 275
topping up 277
- Environment
environmental compatibility 200
- Environmental
ecological driving 200
- Environmental tip
refuelling 266
- Equipment 247

- ESC
 electronic stability control 205
- Ethanol (fuel) 267
- Event Data Recorder 250
- Exhaust gas purification system 202
- Exterior mirrors
 adjusting 18
 vehicle care 255
- Exterior rear view mirrors
 control of the function 142
 electric exterior mirrors 142
 exterior 141
 folding the rear view mirrors 142
- Exterior view 7, 8
- Extinguisher
 driving with a trailer 239
- F**
- Fabrics: cleaning 259
- Fastening rings 160
- Fault
 dynamic chassis control (DCC) 234
 panoramic sunroof 129
 park assist system 215
 parking distance warning system 212
 rear assist 220
- Fault memory
 connector 251
 reading 251
- Filling capacities
 AdBlue tank 268
- Filling the tank 264, 266
- Fire extinguisher 83
- First-aid kit
 storage 83
- Fitting
 tow hitch 244
- Floor mats 61
- Fluid Level control 40
- Fog light 26
- Folding down rear seats
 load space 155
- Folding table 170
- Folding the backrest of the front passenger seat 151
- Folding wheel chocks 84
- Front airbags 72
- Front passenger front airbag
 control lamp 74
 disconnection 74
- Front seat
 manual adjustment 15
- Front wiper blades
 change 55
 cleaning 55
- Fuel 40, 267
 consumption 298
 diesel 268
 refuelling 267
 savings 200
- Fuel consumption
 why does fuel consumption increase? 203
- Fuel gauge
 control lamp 266
 petrol 266
- Fuel tank cap
 opening and closing 40
- Fuel tank flap
 opening and closing 40
- Function control
 tow hitch 242
- Fuses 43, 91
 fuse box 91
 identification using colours 43
 identifying blown fuses 44
- preparation before replacing 44
 replacing 44
- G**
- Gearbox 193
 emergency release 36
- Gearbox lever 35
- Gear change 35
 automatic gearbox 36, 194
 changing gears manually 193
 gear recommendation 197
 manual gear change 35
 putting the vehicle in gear (automatic gearbox) 194
 putting the vehicle in gear (manual gearbox) 193
 Tiptronic 196
- Gear engaged 35
- General instrument panel
 instrument panel 101
- General overview of the engine compartment 274
- Generator 284
- Glove compartment 168
- Glove compartment lighting 136
- H**
- Hand brake
 see Parking brake 190
- Hazard warning lights 26, 134
- Head-on collisions and the laws of physics 64
- Headlamp range adjustment 101
- Headlight range control 135
- Headlights
 adaptive headlights 132
 driving abroad 135
 headlight adjustment 133
 headlight washers 138

- Head restraints 145
 adjustment 17, 144
 assembly and removal 145
- Headrests
 adjustment 17, 144
 assembly and removal 145
- Heat and air conditioning 176
- Heated rear window 38
- Heated windscreen 39
- Heating and air conditioning
 controls 37
- Hitch ball
 electric release 239
- Horn 101
- How to jump start 52
- Hubcaps 46
- I**
- Identifying letters on engine 297
- Ignition 25
 see Engine and ignition 183
- Ignition lock 25
 removal lock 185
 unauthorised vehicle key 184
- Immobiliser 187
- In case of emergency 83
- Indication on display
 Sign Assist 231
- Indications on the display 103
 outside temperature 104
- Information call 111
- Instrument panel 28, 102
 control and warning lamps 34, 107
 display 28, 102, 103
 general instrument panel 101
 instruments 102
 menus 29
- service intervals 105
 symbols 34, 107
- Instruments 102
- Integrated child seat 79
 removing 81
 seat belt routing 81
 setting up 80
- Interior lights 27
- Interior rear vision mirror 140
 anti-dazzle 140
- Interior view
 left guide 9
- ISOFIX 24
- ISOFIX system 24
- J**
- Jack 46, 83, 85
 mounting points 48
- Jump leads 52
- K**
- Keyless Access
 keyless-Entry 117
 keyless-Exit 117
 locking and unlocking the vehicle 117
 starter button 185
 things to note 118
- Keyless Access locking and ignition system
 see Keyless Access 117
- Keys
 control lamp 113
 locking and unlocking 10
 remote control 112
 replacing the battery 113
 spare key 112
- synchronising 114
 unlocking and locking 115, 116
 vehicle key 112
- L**
- Labels and plates 263
- Lane Assist 222
- Lane Assist system 222, 223
 control lamp 223
 malfunction 223
 operation mode 223
 when is it necessary to disconnect it? 224
- Leaving Home 133
- Lift platform 252
- Lighting of the instrument panel 135
- Lights 25, 130, 131
 AUTO 132
 automatic dipped beam control 132
 coming home 133
 control and warning lamps 130
 cornering lights 132
 daytime running lights 132
 dipped beam headlights 131
 driving abroad 135
 fog lights 26
 functions 132
 hazard warning lights 26
 headlight range control 135
 interior lights 136
 leaving home 133
 light controls 131
 lighting of the instruments 135
 lighting of the switches 135
 main beam headlights 131
 main beam lever 131
 main beams 26
 parking light 132

- reading lights 136
 side lights 131
 switch 25
 turn signal lever 131
 Load compartment in the luggage compartment
 see Loading the luggage compartment 154
 Loading the luggage compartment 154
 driving with the rear lid open 153
 Loading the vehicle
 fastening rings 160
 general advice 152
 luggage compartment 12
 net partition 159
 rails and attachment system 161
 roof carrier system 165
 trailer 242
 transporting a load 153
 vehicle loaded 154
 Loads on the axles 298
 Locking and unlocking
 electric panoramic sunroof 129
 electric sliding door 122
 in the lock cylinder 10
 luggage compartment 125
 sliding door 122
 sun blind 129
 with Keyless Access 117
 Locking button 195
 Locking the doors manually if central locking
 fails to work 11
 Luggage 154
 Luggage compartment 12, 124, 154
 closing 125
 driving with the rear lid open 153
 electronic locking 126
 electronic opening 126
 extension 155
 folding down rear seats to create load space . 155
 luggage compartment lighting 136
 manual release mechanism 12
 net 163
 net partition 159
 rails and attachment system 161
 shelf 157
 see also Loading the luggage compartment . 154
 Luggage compartment baggage net 163
 Lumbar massage 148
 Lumbar support 143
- M**
 Main beam lever 131
 Main panel
 turn signal and main beam lever 131
 Malfunction
 air conditioner 177
 automatic gearbox 196, 197
 blind spot detector (BSD) 225
 catalytic converter 203
 diesel particulate filter 203
 lane assist system 223
 windows 128
 Mobile telephone 249
 use without an exterior aerial 251
 Mobile tow hitch ball
 fitting a bicycle carrier 240
 Model plate 297
 Motor oil
 oil properties 41
 Multifunction display 30
- N**
 Net
 luggage compartment 163
 Net partition 159
- Noise
 tyres 296
 Noises
 auxiliary heater 183
 brake assist system 207
 engine 187
 parking brake 190
 Notes for the user 263
 Number of seats 60
- O**
 Octane rating (petrol) 267
 Odometer
 partial 102
 total 102
 Oil properties 41
 Opening 112
 bonnet 13
 electric windows 13
 fuel tank flap 266
 panoramic sunroof 14
 Opening and closing 10, 112
 bonnet 13
 by remote control 115
 door 121
 electric panoramic sunroof 129
 electric sliding door 122
 electric windows 13
 fuel tank flap 266
 in the lock cylinder 10
 panoramic sunroof 14
 rear lid 12
 sliding door 122
 sun blind 129
 with Keyless Access 117
 Opening doors individually 115

- Operating fault
 immobiliser 183
- Optical parking system 213
- Outside temperature 104
- Overview
 Control and warning lamps 34
- P**
- Paintwork
 code 297
- Panoramic sunroof 14, 129
 anti-trap function 130
 emergency locking 15
 fault 129
 sun blind 129
- Park Assist 214
 brake operation 217
- Park assist system
 automatic stoppage 217
 fault 215
 leaving the parking space 216
 parking 215
 preparing to park 215
 stopping 216
 switching on or off (leaving the parking space) 216
 switching on or off (parking) 215
- Park Assist system 214
- Parking 188, 190
- Parking assistance 212, 214
- Parking assistant 229
- Parking assistant (RCTA) 229
- Parking brake
 automatic release 190
 connection 190
 disengaging 190
- electronic 190
 emergency braking function 190
- Parking distance warning system 211
 fault 212
 optical parking system 213
 with towing 212
- Parking light 132, 212
- Passenger front airbag
 disconnecting 20
- Pedals 59, 61
- Petrol
 additives 267
 fuel gauge 266
 refuelling 267
- Polishing 256
- Portable waste bin 170
- Power brake system
 anti-lock system 206
- Power socket 173
 12 volts 174
 faults 175
- Pre-heating 186
- Protection of vehicle undercarriage 258
- Puncture
 action 45
- Pushing the vehicle 183
- R**
- Radio-operated remote control
see Keys 112
- Radio reception
 antenna 263
 operating faults 264
- Rails and attachment element system
 baggage net 162
- Rails and attachment system 161
- Rain sensor 139
 control of function 139
- Raising the vehicle 48
 lift platform 252
- RCTA 229
see Rear cross traffic alert 225
- Rear Assist 217
 fault 220
 instructions for use 218
 mode 1 220
 mode 2 220
 screen 218
 things to note 219
- Rear cross traffic alert (RCTA) 225
 control lamp 225
- Rear lid 12
 emergency locking and unlocking 12
 warning lamp 125
see also Luggage compartment 124
- Rear view camera 217
- Rear view mirrors
 adjusting the exterior mirrors 141
- Recommended gear 197
- Recycled 264
- Reflective vest 83
- Refuelling
 control and warning lamps 266
 fuel gauge 266
 mistakes 265
 opening fuel tank flap 266
- Remote control key
 unlocking and locking 115
- Repairs 248, 264
 airbag system 249
- Repair work 247
- Replacement
 parts 247

- Replacement parts 247
- Replacing bulbs
 see Changing bulbs 92
- Reprogramming control units 250
- Retaining hooks 163
- Revolution counter 102
- Rims
 changing a wheel 46
- Roll-back function
 windows 128
- Rollback anti-trap function
 electric sliding doors 123
- Roof carrier 164
- Roof carrier system 164
 fastening the supports 164
- Roof rack 164
- Rubber seals 257
- Run-flat tyres
 codes 294
- Run-in
 tyres 290
- Running in
 brake pads 191
 new engine 199
- S**
- SAFE 119, 187
- Safe driving 57
- Safety
 child safety 75
 child seats 75
 disconnecting the passenger front airbag 20
 safe driving 57
- Safety equipment 58
- Safety instructions
 using child seats 22, 76
- Sale of vehicle
 in other countries / continents 263
- Salt water 205
- Scrapping 264
- airbag system 264
- vend-of-life vehicles 264
- Seat
 convenient entry function for the third row of
 seats 149
- electric front seat 16
- folding down rear seats 155
- folding the backrest of the front passenger
 seat 151
- heating 147
- incorrect position 60
- number of seats 60
- rear seats 143
- seat with position memory 148
- Seat belt position 66
- for pregnant women 17
- seat belts 17
- Seat belts 62
- adjustment 17, 65
- automatic belt retractor 68
- belt height adjustments 68
- belt tensioner 68
- belt tension limiter 68
- cleaning 262
- protective function 63
- purpose 62
- seat belt position 66
- twisted belt 65
- unfastened 64
- use 65
- warning lamp 63
- with two buckles 67
- Seat belt tensioner 18, 68
- Seat belt with two buckles
 fastening 67
- twisting 67
- unfastening 67
- Seat functions 147
- convenient entry function for the third row of
 seats 149
- folding the backrest of the front passenger
 seat 151
- lumbar massage 148
- Seat heating 147
- SEAT information system 27
- structure 28
- Seats 60
- adjustment 143
- Seat upholstery
 cleaning and maintenance of natural leather . 261
- synthetic leather 261
- Selective Catalytic Reduction 268
- Selector lever locking 195
- Service fluids 247
- Service interval display 105
- Service notification: read 106
- Signal lever 26
- Sign Assist 230, 231
- connection 232
- disconnection 232
- indication on display 231
- operation mode 232
- trailer 232
- Sliding door 122
- childproof lock 123
- manually opening and closing 122
- opening and closing electrically 122
- Snow chains 50, 299
- all-wheel drive 50
- Spanner symbol 106
- Spare fuel canister 265

- Spare parts 247
- Specifications
- combined weight 245
 - drawbar load 237
 - trailer weights 245
- Speed rating 295
- Stabilising the vehicle and trailer combination . 244
- Start-Stop 209
- Start-Stop function 209
- driving with a trailer 237
- Start assist
- see Start assist system 208
- Starter button 185
- Starting assistance
- description 54
 - jump leads 54
 - positive pole 53
- Starting the vehicle 25
- Steering
- control and warning lamps 198
 - counter steering assistance system 199
 - electromechanical 199
 - power steering 199
 - steering column lock 199
 - tendency to pull to one side 293
- Steering wheel
- Adjusting 59
 - adjustment 18
- Steering wheel controls 108
- Storage
- compartment for (sun)glasses 166
 - Storage compartment in the roof console 167
 - Storage compartments 166
 - cards 168
 - drawers 169
 - folding table 170
 - glove compartment 168
 - glove compartment lighting 136
 - instrument panel 167
 - other storage compartments 170
 - portable waste bin 170
 - rear footwell 169
 - roof console 167
- Sun blind
- anti-trap function 130
 - opening and closing 129
 - rear side windows 137
- Sun protection 136
- Sun visors 136
- Switch
- hazard warning lights 134
- Switching lights off 131
- Switching lights on 131
- Switching the ignition on and off 25
- Symbols
- see Control and warning lamps 34, 107
- Systems
- tyre monitoring systems 234
- T**
- Technical data
- engine oil specifications 275
 - roof load 165
- Technical details
- capacities 283
 - loads on the axles 298
 - tyre pressure 291
 - weights 298
- Technical features 297
- Technical modifications 248
- Technical specifications
- dimensions 305
- Telephone management
- three button unit 110
- Tightening torque 299
- wheel bolts 48
- TIN 294
- Tiptronic 196
- Tiredness detection 232
- Top Tether 24
- Top Tether system 24
- Tow-starting 52, 88
- Tow hitch
- electric release 239
 - fitting a bicycle carrier 240
 - function control 242
- Towing
- blind spot detector (BSD) 230
 - parking distance warning system 212
 - special characteristics 230
 - things to note 52
- Towing a trailer 298
- Towing bracket 237
- optical parking system 213
- Towing the vehicle 51, 88, 183
- driving tips 90
 - front towline anchorage 89
 - rear towline anchorage 89
- Towline anchorages 51
- Traction 295
- Traction control system 205
- Traction control (ASR) 206, 207
- Traffic signal detection 230
- Trailer 237
- adjusting the headlights 243
 - anti-theft alarm 241
 - connecting 240
 - drawbar load 237
 - driving with a trailer 243
 - electrically releasing the hitch ball 239
 - electrical socket 241

- fitting a tow hitch 244
function control 242
hitch ball 239
hitching 240
loading 242
rear LED lights 238, 241
rear lights 238, 241
stabilising the vehicle and trailer combination 244
trailer cable 238, 241
trailer weights 245
wing mirrors 238
- Trailer cable 238, 241
Trailer weight 298
permitted maximum 245
- Transporting
baggage net 163
driving with a trailer 243
driving with the rear lid open 153
folding the backrest of the front passenger seat 151
load 153
loading the trailer 242
net partition 159
rails and attachment system 161
retaining hooks 163
vehicle loaded 154
- Transporting children 75
- Transporting items
fastening rings 160
roof carrier 164
roof carrier system 164
- Transporting objects
roof carrier system 165
trailer weights 245
- Treadwear 295
Turn signal convenience function 131
Turn signal lever 131
- Tyre control systems
tyre pressures 291
- Tyre load rating 295
- Tyre mobility set
more than one damaged tyre 86
- Tyre Mobility Set 45
check after 10 minutes 87
components 87
inflating a tyre 87
sealing a tyre 87
- Tyre Mobility System
see Anti-puncture kit 86
- Tyre monitoring systems 234, 236
control lamp 235
- Tyre pressure 291, 299
Tyre profile 292
Tyre repair 86
Tyre repair kit
see Anti-puncture kit 86
- Tyres
avoiding damage 288
changing 46
changing wheels 289
code 294
deterioration 293
errors in wheel alignment 293
foreign bodies in the tyres 293
handling 288
new 290
old 289
pressure 291
replacing 290
run-flat tyre codes 294
run-out 293
serial number 294
snow chains 50
speed rating 294, 295
- storing 289
technical details 294
tyre code 294
tyre identification number (TIN) 294
tyre load rating 295
tyre pressure sensor 292
tyres with directional tread pattern 295
tyre wear 293
valve caps 292
wear indicators 292
wheel balancing 293
wheels 289
winter tyres 295
with directional tread pattern 50
- Tyres with directional tread pattern 295
Tyre tread depth 292
Tyre wear 292, 293
- ## U
- Unfastening your seat belt 65
Unfasten the seat belt 17
Unlocking and locking 10
by remote control 115
door 121
from inside 116
- Upholstery cleaning
textile covers 260
- Upholstery: cleaning
upholstery 259, 260
- USB/AUX-IN input 110, 166
- ## V
- Valve caps 292
Vanity mirror 136
Vehicle
data label 297
identification data 297

- identification number 297
 - loading 152
 - parking downhill 191
 - parking uphill 191
 - raising 48
 - recycling 264
 - vehicle identification number 297
 - Vehicle battery 42, 283
 - acid 285
 - assisted starting 52
 - automatically disconnecting devices 286
 - charging 285
 - checking the battery electrolyte level 285
 - connecting 285
 - control and warning lamps 284
 - discharging 183, 185
 - disconnect 107
 - disconnecting 285
 - positive terminal for starting assistance 53
 - preparations 285
 - replacing 285
 - starting assistance 54
 - Vehicle care 253
 - airbag modules (dash panel) 262
 - anodized surfaces 257
 - antenna incorporated in window 263
 - chrome parts 257
 - cleaning wheels 257
 - dash panel 262
 - de-icing the door lock cylinder 258
 - engine compartment 258
 - exterior mirrors 255
 - interior 259
 - plastic parts 262
 - protection of vehicle undercarriage 258
 - rubber seals 257
 - things to note 254
 - vehicle paintwork 256
 - windows 255
 - wooden trim 262
 - Vehicle care products 253
 - Vehicle identification data
 - vehicle data label 297
 - Vehicle interior monitoring 120
 - Vehicle key set 112
 - Vehicle tool kit 46, 83
 - components 84
 - location 83
 - Vehicle undercarriage guard 57
 - Vehicle's battery
 - running flat 286
 - Vibrations
 - steering 293
 - Voice control 111
- W**
- Warning lamps 34
 - Warning triangle 83, 134
 - Washing the vehicle 253
 - adhesive sheets 255
 - sensors 211, 215
 - things to note 118, 254
 - Wax 256
 - Wear indicators 292
 - Weights 298
 - What negatively affects driving safety? 57
 - Wheel bolts 85, 299
 - anti-theft 46, 84, 85
 - caps 47
 - loosening 47
 - tightening torque 48
 - Wheel load capacity 294
 - Wheel rims
 - beadlock 290
 - bolted trims 290
 - Wheels 287, 289, 299
 - changing a wheel 46, 49, 85
 - hubcaps 46
 - Wheel trim
 - hubcaps 46
 - remove 47
 - Windows
 - automatic operation 127
 - automatic raising/lowering 127
 - convenience closing 127
 - convenience opening 127
 - electric 13
 - malfunction 128
 - removing ice 255
 - roll-back function 128
 - Window wiper 137
 - Window wiper blade 27
 - Windscreen and rear window wiper blades 88
 - Windscreen washer 42, 137
 - Windscreen washer fluid
 - control lamp 137
 - Windscreen washer water
 - checking 283
 - topping up 283
 - Windscreen wiper 137
 - heated windscreen washer jets 138
 - Window wiper lever 137
 - Windscreen wipers 27
 - functions 138
 - headlight washer system 138
 - lifting the wiper blade 55
 - rain sensor 139
 - replacing the wiper blade 55

- service position 55
- special characteristics 138
- Windscreen wipers service position 55
- Wing mirrors
 - driving with a trailer 238
- Winter
 - additional heater 180
 - menu configuration 31
- Winter conditions
 - diesel 268
- Winter driving
 - Driving with a trailer 237
 - winter tyres 295
- Winter operation
 - headlight washers 138
 - heated windscreen washer jets 138
 - salt on the roads 139
- Winter tyres
 - all-wheel drive 296
 - speed limit 296
- X**
- XDS
 - See Brake assistance systems 206


SEAT S.A. is permanently concerned about continuous development of its types and models. For this reason we ask you to understand, that at any given time, changes regarding shape, equipment and technique may take place on the car delivered. For this reason no right at all may derive based on the data, drawings and descriptions in this current handbook.

All texts, illustrations and standards in this handbook are based on the status of information at the time of printing. Except for error or omission, the information included in the current handbook is valid as of the date of closing print.

Re-printing, copying or translating, whether total or partial is not allowed unless SEAT allows it in written form.

SEAT reserves all rights in accordance with the "Copyright" Act.

All rights on changes are reserved.

 This paper has been manufactured using bleached non-chlorine cellulose.

© SEAT S.A. - Reprint: 15.11.17

Inglés 7N5012720BJ (1.1.17)



7N5012720BJ



SEAT recommends
SEAT **GENUINE OIL**



SEAT recommends
Castrol **EDGE Professional**