



# Mii

Owner's manual

## Vehicle identification data

Model:
Vehicle Registration:
Vehicle identification number:
Date of vehicle registration or vehicle delivery:
SEAT Official Service:
Service advisor:
Telephone:

## Confirmation of receipt of documentation and vehicle keys

The following items were delivered with the vehicle:	YES	NO
On-board documentation	<input type="checkbox"/>	<input type="checkbox"/>
First key	<input type="checkbox"/>	<input type="checkbox"/>
Second key	<input type="checkbox"/>	<input type="checkbox"/>
Correct working order of all keys was checked	<input type="checkbox"/>	<input type="checkbox"/>
Location:		
Date:		
Signature of owner:		

## Introduction

Thank you for your trust choosing a SEAT vehicle.

With your new SEAT, you will be able to enjoy a vehicle with state-of-the-art technology and top quality features.

We recommend reading this Instruction Manual carefully to learn more about your vehicle so you can enjoy all its benefits in your daily driving.

Information about handling is complemented with instructions regarding the operation and maintenance of the vehicle in order to ensure its safety and maintain its value. Moreover, we want to give you valuable advice and tips to drive your vehicle efficiently and respecting the environment.

We wish you safe and enjoyable motoring.

**SEAT, S.A.**

### **WARNING**

**Read and always observe safety information concerning the passenger's front airbag »» page 28, Fitting and using child seats.**

## About this manual

This manual describes the **features** of the vehicle at the time of drafting this text. Some of the features described below will be introduced in the future or will only be available in certain markets.

**Some of the features described here are not included in all the types or variations of the model and they can be varied or modified based on technical or marketing requirements without it being considered misleading advertising.**

Some details on the **drawings** may vary from its vehicle and must be interpreted as a standard representation.

The **direction indicators** (left, right, forwards, backwards) in this manual refer to the travel direction of the vehicle unless otherwise stated.

The **audiovisual material** is only meant to help the users better understand some features of the car. It is not a replacement for the instruction manual. Access the instruction manual to see the complete information and warnings.

★ The **features marked with an asterisk** are included by default only in certain versions of the model, supplied as optional only for certain versions or only offered in certain countries.

- Ⓜ **Trademarks** are marked with ®. The absence of this symbol does not guarantee that the term is not a trademark.
- » It indicates that the section continues on the next page.

You can access the information in this manual using:

- Thematic table of contents that follows the manual's general chapter structure.
- Visual table of contents that uses graphics to indicate the pages containing "essential" information, which is detailed in the corresponding chapters.
- Alphabetical index with many terms and synonyms to help you find information.

### **WARNING**

**Texts after this symbol contain information about safety and warn you about possible accident or injury risks.**

### **CAUTION**

**Texts after this symbol indicate possible damage to the vehicle.**

### **For the sake of the environment**

**Texts after this symbol contain information about the protection of the environment.**

### **Note**

**Texts after this symbol contain additional information.**

## Digital instruction manual

The digital version of the manual can be found on SEAT's official website:



- scan the QR code »» **Fig. 1**
- **OR** enter the following address in the navigator website:

<http://www.seat.com/owners/your-seat/manuals-offline.html>

and select your vehicle.



## Table of Contents

<b>General views of the vehicle</b> .....	7	<b>Operation</b> .....	55	Power sockets .....	97
<b>Exterior view</b> .....	7	<b>Controls and displays</b> .....	55	Smartphone support .....	98
<b>Overview (left hand drive)</b> .....	8	Interior view .....	55	<b>Air conditioning</b> .....	100
<b>Interior view</b> .....	9	<b>Instruments and warning/control lamps</b> .....	56	Heating, ventilation and cooling .....	100
<b>Safety</b> .....	10	Instrument panel .....	56	Stationary air conditioning .....	104
<b>Safe driving</b> .....	10	Using the instrument panel .....	63	<b>Infotainment System</b> .....	107
Advice about driving .....	10	Control lamps .....	65	<b>Introduction</b> .....	107
Correct sitting position of vehicle occupants .....	11	<b>Opening and closing</b> .....	67	Safety warnings .....	107
Pedal area .....	13	Set of vehicle keys .....	67	Overview of the unit .....	109
<b>Seat belts</b> .....	14	Central locking .....	69	General instructions for use .....	111
The whys and wherefores of seat belts .....	14	Doors .....	72	<b>Operating modes</b> .....	115
How to properly adjust your seat belt .....	17	Rear lid .....	73	Radio .....	115
Seat belt tensioners .....	19	Window controls .....	75	Digital radio mode* .....	118
<b>Airbag system</b> .....	20	<b>Lights</b> .....	76	Media .....	120
Brief introduction .....	20	Vehicle lighting .....	76	Telephone .....	125
Operation of the airbags .....	22	Interior lights .....	81	Drive Mii App* .....	128
<b>Transporting children safely</b> .....	26	<b>Visibility</b> .....	82	<b>Connectivity</b> .....	129
Safety for children .....	26	Windscreen wiper and rear window wiper systems .....	82	Cybersecurity .....	129
<b>Emergencies</b> .....	34	Mirrors .....	84	SEAT CONNECT .....	130
<b>Self-help</b> .....	34	Sun protection .....	85	<b>Driving</b> .....	133
Emergency equipment .....	34	<b>Seats and head restraints</b> .....	86	<b>Drive system and driving</b> .....	133
Tyre repairs .....	35	Adjusting seats .....	86	Driving indications .....	133
Changing a wheel .....	38	Headrest .....	87	Connecting and disconnecting the drive system .....	135
Changing the windscreen wiper blades .....	43	Seat functions .....	88	Gear selection .....	140
Jump start .....	44	<b>Transport and practical equipment</b> .....	89	Hill driving assistant .....	143
Tow start and towing .....	46	Storing objects .....	89	Steering .....	143
<b>Fuses and bulbs</b> .....	47	Luggage compartment .....	90	Driving profiles .....	144
Fuses .....	47	Roof carrier* .....	92	Driving tips .....	145
Changing bulbs .....	49	Storage compartment .....	94	<b>Driver assistance systems</b> .....	146
		Drink holder .....	96	Cruise control system [CCS]* .....	146
				Lane Assist* .....	148

## Table of Contents

<b>Braking and parking</b> .....	150	<b>Vehicle maintenance</b> .....	196
Braking system .....	150	Maintenance and cleaning .....	196
Stabilisation and brake assistance systems .....	152	<b>Accessories and modifications to the vehicle</b> .....	202
Parking .....	154	Accessories, spare parts and repair work ...	202
<b>Help with parking and manoeuvring</b> .....	155	<b>Information for the user</b> .....	204
Parking distance warning system* .....	155	<b>Information for the user</b> .....	204
<b>Towing bracket device</b> .....	157	Information stored by the control units .....	204
Trailer mode .....	157	Other important information .....	205
<b>Practical tips</b> .....	158	Information about the EU Directive 2014/53/EU .....	207
<b>High-voltage battery</b> .....	158	<b>Technical data</b> .....	211
Safety warnings relating to the high-voltage network and the high-voltage battery .....	158	<b>Indications about the technical data</b> .....	211
Charging the high-voltage battery .....	160	Important information .....	211
Charging cable .....	170	<b>Index</b> .....	215
<b>Verification and replacement</b> .....	174		
Engine compartment .....	174		
Cooling system .....	178		
Brake fluid .....	180		
Windscreen washer reservoir .....	181		
12-volt battery .....	182		
<b>Wheels</b> .....	186		
Wheels and tyres .....	186		
Tyre pressure monitor system* .....	192		
<b>Maintenance</b> .....	194		
<b>SEAT Maintenance Programme</b> .....	194		
Service intervals .....	194		
Additional service offers .....	195		
Warranty .....	196		



## Exterior view

**① Opening and closing**

- Doors »» page 72
- Central locking »» page 69

**② Rear lid**

- Opening from outside »» page 74
- Emergency opening »» page 75

**③ High-voltage battery charging socket**

- Open/Close cap »» page 160

**④ Levels control**

- Brake fluid »» page 180

- Battery 12V »» page 182

**⑤ Bonnet**

- Unlocking lever »» page 177
- Open/close »» page 177

**⑥ Action in the event of a puncture**

- Anti-puncture kit »» page 35
- Wheel change »» page 38

**⑦ Towing the vehicle**

- Towline anchorage »» page 46

## Overview (left hand drive)

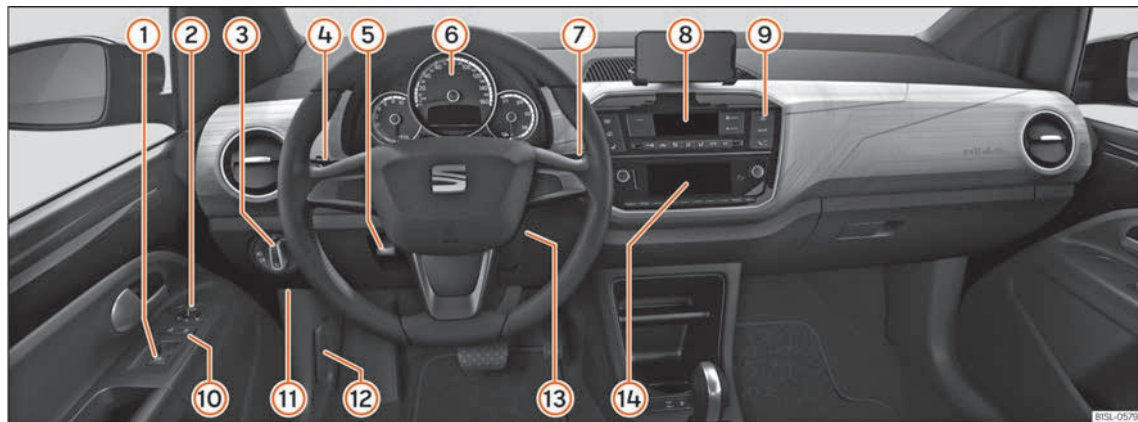

- |   |   |
|---|---|
| ① Electric windows »» page 75                   | Driver information system »» page 63                  |
| ② Exterior mirror adjustment »» page 84         | ⑧ Air conditioning »» page 100                        |
| ③ Headlight switch »» page 77                   | ⑨ Hazard warning lights »» page 80                    |
| ④ Turn signal and main beam lever<br>»» page 78 | ⑩ Central locking »» page 69                          |
| Cruise control »» page 146                      | ⑪ Fuses »» page 47                                    |
| ⑤ Steering wheel adjustment »» page 13          | ⑫ Open bonnet lever »» page 177                       |
| ⑥ Warning lamps »» page 65                      | ⑬ Ignition lock »» page 135                           |
| ⑦ Wipers and rear window wiper<br>»» page 82    | ⑭ Infotainment system (factory fitted)<br>»» page 107 |

## Interior view



- ① Headrest adjustment »» page 87
- ② Isofix anchors »» page 29
- ③ Seat belts »» page 14
- ④ Interior mirror »» page 84
- ⑤ Handbrake »» page 152
- ⑥ Disconnecting the front passenger front airbag »» page 23

## Safety

### Safe driving

#### Advice about driving

##### Safety first!

##### WARNING

- This manual contains important information about the operation of the vehicle, both for the driver and the passengers. The other sections of the on-board documentation also contain further information that you should be aware of for your own safety and for the safety of your passengers.
- Ensure that the on-board documentation is kept in the vehicle at all times. This is especially important when lending or selling the vehicle to another person.

##### Before driving

For your own safety and the safety of your passengers, always note the following points before every trip:

- Make sure that the vehicle's lights and turn signals are working properly.
- Check tyre pressure.

- Ensure that all windows provide a clear and good view of the surroundings.
- Do not block the entrance of air to the electric drive train or cover it with blankets or insulating materials.
- Make sure all luggage is secured  
»» page 89.
- Make sure that no objects can interfere with the pedals.
- Adjust front seat, head restraint and mirrors properly according to your size.
- Ensure that the passengers in the rear seats always have the head restraints in the in-use position »» page 87.
- Instruct passengers to adjust the head restraints according to their height.
- Protect children with appropriate child seats and properly applied seat belts  
»» page 26.
- Assume the correct sitting position. Instruct your passengers also to assume a proper sitting position »» page 11.
- Fasten your seat belt securely. Instruct your companions to fasten their seat belt properly »» page 14.

##### Factors influencing safety

You, as the driver, are responsible for your safety and that of your companions.

- Always pay attention to traffic and do not get distracted by passengers or telephone calls.
- Never drive when your driving ability is impaired (e.g. by medication, alcohol, drugs).
- Observe traffic laws and speed limits.
- Always reduce your speed as appropriate for road, traffic and weather conditions.
- On long trips, stop regularly to rest, at least every two hours.
- If possible, avoid driving when you are tired or stressed.

##### WARNING

**Driving under the influence of alcohol, drugs, medication or narcotics may result in severe accidents and even loss of life.**

- Alcohol, drugs, medication and narcotics may significantly alter perception, affect reaction times and safety while driving, which could result in the loss of control of the vehicle.

## Safety equipment

Never put your safety or the safety of your passengers in danger. In the event of an accident, the safety equipment may reduce the risk of injury. The following points cover part of the safety equipment in your SEAT<sup>1)</sup>:

- three-point seat belts,
- belt tension limiter for the front and rear seats
- belt tensioners for the front and rear seats,
- front and rear airbags,
- side airbags on the backs of the front seats, and head airbags for the front and rear seats.
- "ISOFIX" anchor points for child seats in the rear side seats with the "ISOFIX" system,
- rear head restraints with in-use position and non-use position,
- adjustable steering column.

The safety equipment mentioned above works together to provide you and your passengers with the best possible protection in the event of an accident. However, these safety systems can only be effective if you and your passengers are sitting in a correct position and use this equipment properly.

### Safety is everyone's business!

## Correct sitting position of vehicle occupants

### Correct position on the seat

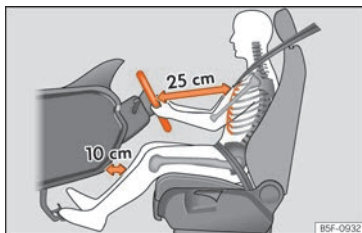

**Fig. 2** The correct distance between the driver and the steering wheel must be at least 25 cm [10 inches].

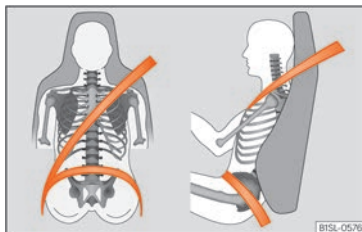

**Fig. 3** Seat belt adjusted correctly.

The correct sitting positions for the driver and passengers are shown below.

If your physical constitution prevents you from maintaining the correct sitting position, contact a specialised workshop for help with any special devices. The seat belt and airbag can only provide optimum protection if a correct sitting position is adopted. SEAT recommends taking your car in for technical service.

For your own safety and to reduce the risk of injury in the event of an accident or sudden braking or manoeuvre, SEAT recommend the following positions:

#### Valid for all vehicle occupants:

- Keep the back of your neck as close as possible to the headrest »» **Fig. 3.**
- Always keep your feet in the footwell while the vehicle is in motion.
- Adjust and fasten your seat belt correctly »» **page 17.**

#### The following also applies to the driver:

- Move the seat backrest to an almost upright position so that your back rests completely against it.
- Move the steering wheel so it is at least 25 cm [10 inches] away from the sternum »»

<sup>1)</sup> Depending on the version/market.

»» **Fig. 2** and you can hold it with both hands on both sides, on the outer part, with your arms slightly bent.

- The steering wheel must always point towards the chest and never towards the face.
- Move the seat in such a way that you can step on the pedals with your knees slightly bent and with a distance between the knees and the dashboard of at least 10 cm (4 inches) »» **Fig. 2**.
- Adjust the height of the seat so that you can reach the top of the steering wheel.
- Always keep both feet in the footwell so that you have the vehicle under control at all times.

#### For the passenger, the following applies:

- Move the seat backrest to an almost upright position so that your back rests completely against it.
- Move the seat as far back as possible (minimum 25 cm between the chest and the instrument panel check translation). If you are sitting closer than 25 cm, the airbag system cannot protect you properly.

### Number of seats

The vehicle has **4** seats, 2 in the front and 2 in the rear. All seats are equipped with a safety belt.

### WARNING

**Sitting in an incorrect position may increase the risk of severe or lethal injuries in the event of sudden braking or manoeuvring, in case of collision or accident and if the airbags deploy.**

- **Before starting the car, all passengers must be sitting in a correct position and stay like that for the entire journey. This also applies to a correct use of the seat belt.**
- **The maximum amount of people in the vehicle is the same as the amount of seats with seat belts.**
- **For children, always use a certified protection system, certified and suited for their weight and height** »» page 26.
- **While driving, always keep your feet in the footwell. Never place them over the seat or the instrument panel, for example, or outside the window. Otherwise the airbag and seat belt may offer insufficient protection and also increase the risk of injury in the event of an accident.**

### Risks of sitting in an incorrect position

If seat belts are worn incorrectly or not at all, the risk of severe or lethal injuries increases. Seat belts can provide optimal protection only if the belt web is properly worn. Incorrect sitting positions substantially reduce the pro-

TECTIVE function of seat belts and, therefore, increase the risk of severe or even lethal injuries. The risk of severe or fatal injuries is especially heightened when a deploying airbag strikes a vehicle occupant who has assumed an incorrect sitting position. The driver is responsible for all people, particularly children, inside the vehicle.

The following list contains examples of incorrect sitting positions that could be dangerous for all vehicle occupants.

#### When the vehicle is in motion:

- Never stand in the vehicle.
- Never stand on the seats.
- Never kneel on the seats.
- Never tilt your seat backrest too far to the rear.
- Never lean against the instrument panel.
- Never lie on the rear seats.
- Never sit on the front edge of a seat.
- Never sit sideways.
- Never lean out of a window.
- Never put your feet out of a window.
- Never put your feet on the instrument panel.
- Never place your feet on the bench or on the backrest of the seat.
- Never travel in a footwell.
- Never sit on the armrests.

- Never travel without wearing the seat belt.
- Never travel in the luggage compartment.

### **⚠ WARNING**

Sitting in an incorrect position increases the risk of severe or fatal injuries in the event of accidents and sudden braking or manoeuvres.

- All occupants must sit correctly during the journey and wear the seat belt correctly.
- Occupants of the vehicle that are not sitting correctly, not wearing the seat belt or are not at a proper distance of the airbag risk suffering very serious or lethal injuries, especially if the airbags deploy and strike them.

### Steering wheel position adjustment



**Fig. 4** Lever in the lower left side of the steering column.

Adjust the steering wheel before your trip and only when the vehicle is stationary.

- Pull the »» Fig. 4 ① lever down, move the steering wheel to the desired position and lift the lever back up until it locks.

### **⚠ WARNING**

Incorrect use of the steering wheel adjustment function and an incorrect adjustment of the steering wheel can result in severe or fatal injury.

- After adjusting the steering column, push the lever »» Fig. 4 ① firmly upwards to ensure the steering wheel does not accidentally change position while driving.

- Never adjust the steering wheel while the vehicle is in motion. If you need to adjust the steering wheel while the vehicle is in motion, stop safely and make the proper adjustment.
- The adjusted steering wheel should be facing your chest and not your face so as not to hinder the driver's front airbag protection in the event of an accident.
- When driving, always hold the steering wheel with both hands on the outside of the ring at the 9 o'clock and 3 o'clock positions to reduce injuries when the driver's front airbag deploys.
- Never hold the steering wheel at the 12 o'clock position or in any other manner (e.g. in the centre of the steering wheel). In such cases, if the driver's airbag deploys, you may sustain injuries to your arms, hands and head.

## Pedal area

### Pedals

- Make sure you can always step on the brake and accelerator pedals without any problems.
- Ensure that the pedals can return unimpeded to their initial positions.

»

- Ensure that the floor mats are securely fastened during the trip and do not obstruct the pedals »» » ⚠.

Only use floor mats which leave the pedals clear and which are secured to prevent them from slipping. You can obtain suitable floor mats from a specialised dealership. Fasteners\* for floor mats are fitted in the footwells.

If a brake circuit fails, the brake pedal must be pressed down thoroughly in order to stop the vehicle.

### Wear suitable footwear

Always wear shoes which support your feet properly and give you a good feeling for the pedals.

### ⚠ WARNING

- Restricting pedal operation can lead to critical situations while driving.
- Never lay or fit floor mats or other floor coverings over the original floor mats. This would reduce the pedal area and could obstruct the pedals. Risk of accident.
- Never place objects in the driver footwell. An object could move into the pedal area and impair pedal operation.

## Seat belts

### The whys and wherefores of seat belts

#### Control lamps



#### It lights up red

Driver or passenger has not fastened seat belt.

Objects on the front passenger seat. Remove the objects from the front passenger seat and store them safely.

The control lamp  lights up to remind the driver to fasten their seat belt.

Before starting the vehicle:

- Fasten your seat belt securely.
- Instruct your passengers to fasten their seat belts properly before driving off.
- Protect children by using a child seat according to the child's height and weight »» page 26.

When starting to drive, if the vehicle's speed exceeds approx. 25 km/h (15 mph) and the seat belts are not fastened or are unfastened while driving, a warning sound will be heard for a few seconds. The warning light will also flash .

The lamp  goes out when the driver and passenger seat belts are fastened with the ignition switched on.

#### Rear seat belts fastened display\*

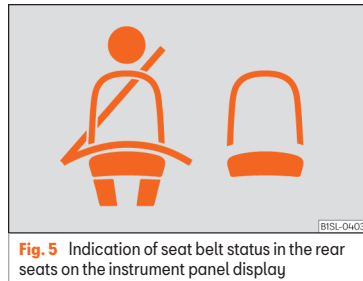

**Fig. 5** Indication of seat belt status in the rear seats on the instrument panel display

When the ignition is switched on, the status display of the seat belts »» **Fig. 5** informs the driver on the instrument panel display whether the occupants of the rear seats have their seat belts fastened.



It indicates that the corresponding seat is empty.



Indicates that the seat is occupied and the occupant is wearing the seat belt.

The seat belt status flashes for a maximum of 30 seconds when a seat belt in the rear seats is unfastened while the vehicle is in motion. An



audible warning will also be heard if the vehicle is travelling at over 25 km/h (15 mph).

If a seat belt is fastened or unfastened while driving in some of the rear seats, the seat belt status is displayed for approximately 30 seconds. The indication can be hidden by pressing the **0.0/SET** button on the instrument panel.

### The protective function of seat belts



**Fig. 6** Drivers with properly worn seat belts will not be thrown forward in the event of sudden braking.

Properly worn seat belts hold the occupants in the proper position. They also help prevent uncontrolled movements that may result in serious injury and reduce the risk of being thrown out of the vehicle in case of an accident.

Vehicle occupants wearing their seat belts correctly benefit greatly from the ability of the belts to absorb kinetic energy. In addition, the front part of your vehicle and other passive safety features (such as the airbag system) are designed to absorb the kinetic energy released in a collision. Taken together, all these features reduce the releasing kinetic energy and consequently, the risk of injury. This is why it is so important to fasten seat belts before every trip, even when "just driving around the corner".

Ensure that your passengers wear their seat belts as well. Accident statistics have shown that wearing seat belts is an effective means of substantially reducing the risk of injury and improving the chances of survival when involved in a serious accident. Furthermore, properly worn seat belts improve the protection provided by airbags in the event of an accident. For this reason, wearing a seat belt is required by law in most countries.

Although your vehicle is equipped with airbags, the seat belts must be fastened and worn. The front airbags, for example, are only triggered in some cases of head-on collision. The front airbags will not be triggered during minor frontal or side collisions, rear-end collisions, overturns or accidents in which the airbag trigger threshold value in the control unit is not exceeded.

### Important safety instructions for the use of seat belts

- Always wear the seat belt as described in this section.
- Ensure that the seat belts can be fastened at all times and are not damaged.

#### **⚠ WARNING**

- If seat belts are worn incorrectly or not at all, the risk of severe injuries increases. The optimal protection from seat belts can be achieved only if you use them properly.
- Never allow two passengers (even children) to share the same seat belt.
- Never unbuckle a seat belt while the vehicle is in motion. Risk of fatal injury.
- The seat belt should never lie on hard or fragile objects (such as glasses or pens, etc.) because this can cause injuries.
- Do not allow the seat belt to be damaged or jammed, or to rub on any sharp edges.
- Never wear the seat belt under the arm or in any other incorrect position.
- Bulky and unfastened clothing (such as an overcoat over a sweater) impairs the proper fit and function of the seat belts, reducing their capacity to protect.
- The slot in the seat belt buckle must not be blocked with paper or other objects, as this can prevent the latch plate from engaging securely.

- Never use seat belt clips, fastening rings or similar items to alter the position of the belt webbing.
- Frayed or torn seat belts or damage to the connections, belt retractors or parts of the buckle could cause severe injuries in the event of an accident. Therefore, you must check the condition of all seat belts at regular intervals.
- Seat belts which have been worn in an accident and have been stretched must be replaced by a specialised workshop. Renewal may be necessary even if there is no apparent damage. The belt anchorage should also be checked.
- Do not attempt to repair a damaged seat belt yourself. The seat belts must not be removed or modified in any way.
- The belts must be kept clean, otherwise the retractors may not work properly.

## Head-on collisions and the laws of physics

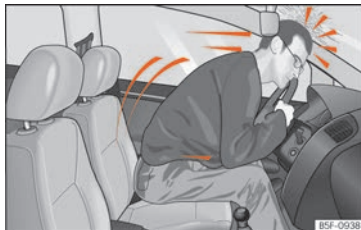

**Fig. 7** A driver not wearing a seat belt is thrown forward violently.



**Fig. 8** The unbelted passenger in the rear seat is thrown forward violently, hitting the driver who is wearing a seat belt.

The effects of the laws of physics in the case of a head-on collision are easy to explain: the moment a vehicle starts moving, a type of en-

ergy called “kinetic energy” starts acting on both the vehicle and its passengers.

The amount of “kinetic energy” depends on the speed of the vehicle and on the weight of the vehicle and of its passengers. The higher they are, the more energy there is to be “absorbed” in the event of an accident.

The most significant factor, however, is the speed of the vehicle. If the speed doubles from 25 km/h (15 mph) to 50 km/h (30 mph), for example, the corresponding kinetic energy is multiplied by four.

Given that the passengers of the vehicle in our example do not have their seat belts fastened, in the event of a collision the entire amount of the passengers' kinetic energy will be only absorbed by the mentioned impact.

Even at speeds of 30 km/h (19 mph) to 50 km/h (30 mph), the forces acting on bodies in a collision can easily exceed one tonne (1000 kg). At greater speed these forces are even higher.

Vehicle occupants not wearing seat belts are not “attached” to the vehicle. In a head-on collision, they will move forward at the same speed their vehicle was travelling just before the impact. This example applies not only to head-on collisions, but to all accidents and collisions.

Even at low speeds the forces acting on the body in a collision are so great that it is not

possible to brace oneself with one's hands. In a frontal collision, unbelted passengers are thrown forward and will make violent contact with the steering wheel, dash panel, wind-screen or whatever else is in the way » **Fig. 7.**

It is also important for rear passengers to wear seat belts properly, as they could otherwise be thrown forward violently through the vehicle interior in an accident. Passengers in the rear seats who do not use seat belts endanger not only themselves but also the front occupants » **Fig. 8.**

## How to properly adjust your seat belt

### Fastening and unfastening the seat belt

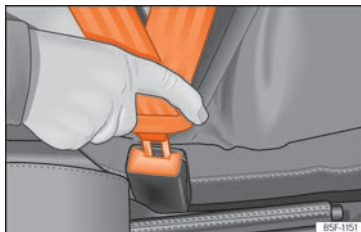

**Fig. 9** Insert the latch plate of the seat belt into the buckle.

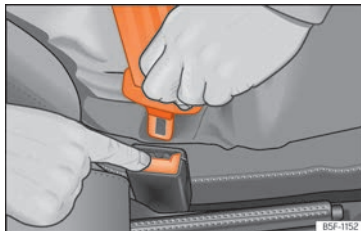

**Fig. 10** Release the seat belt's buckle.

Properly worn seat belts hold the vehicle occupants in the position that most protects them in the event of an accident or sudden braking » **△.**

### Fastening the seat belt

Fasten your seat belt before each trip.

- Adjust the front seat and head restraint correctly » **page 11.**
- Engage the seat backrest of the rear seat in an upright position » **△.**
- Pull the latch plate and place the belt webbing evenly across your chest and lap. Do **not** twist the seat belt when doing so » **△.**
- Engage the latch plate in the buckle of the corresponding seat » **Fig. 9.**
- Pull the belt to ensure that the latch plate is securely engaged in the buckle.

### Releasing the seat belt

Only unfasten the seat belt when the vehicle has come to a standstill » **△.**

- Press the red button on the buckle » **Fig. 10.** The latch plate is released from the buckle.
- Guide the belt back by hand so that it rolls up easily and the trim will not be damaged. »

**⚠ WARNING**

- The seat belt cannot offer its full protection unless the seat backrest is in an upright position and the seat belt is worn correctly, according to your size.
- Unbuckling your seat belt while the vehicle is in motion can cause severe or fatal injuries in the event of an accident or sudden braking.
- The seat belt itself, or a loose seat belt, can cause severe injuries if the belt moves from hard areas of the body to soft areas [e.g. the stomach].

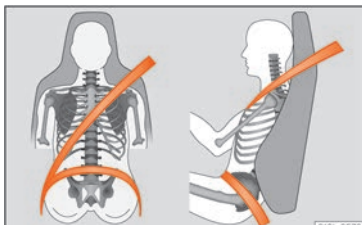
**Correct seat belt position**

**Fig. 11** Seat belt adjusted correctly, front and side view.



**Fig. 12** Position of seat belt during pregnancy.

Seat belts offer their maximum protection in the event of an accident and reduce the risk of sustaining severe or fatal injuries only when they are properly positioned. Furthermore, if the webbing is correctly positioned, the seat belt will hold the vehicle occupants in the optimum position to ensure the airbag provides the maximum protection. The seat belt must therefore always be worn and the webbing correctly positioned.

Incorrectly worn seat belts can cause severe or even fatal injuries »» page 11, Correct sitting position of vehicle occupants.

- The shoulder part of the seat belt must lie on the centre of the shoulder, never across the neck or the arm, under the arm or behind the shoulder.
- The lap part of the seat belt must lie across the pelvis, never across the stomach.

- The seat belt must lie flat and fit comfortably. Pull the belt tight if necessary to take up any slack.

In the case of **pregnant women**, the seat belt must lie evenly across the chest and as low as possible over the pelvis, never across the stomach and must be worn properly at all times during the pregnancy »» **Fig. 12**.

**Adapting the position of the belt webbing to your size**

The seat belt can be adapted using the following equipment:

- Belt height adjustment for the front seats.

**⚠ WARNING**

**An incorrectly worn seat belt web can cause severe or fatal injuries in the event of an accident.**

- The shoulder part of the seat belt must lie on the centre of the shoulder, never across the neck or the arm.
- The seat belt must lie flat and fit comfortably on the torso
- The lap part of the seat belt must lie across the pelvis, never across the stomach. The seat belt must lie flat and fit comfortably on the pelvis Pull the belt tight if necessary to take up any slack.
- For pregnant women, the lap part of the seat belt must lie as low as possible over

the pelvis and always lie flat, “surrounding” the stomach »» Fig. 12.

- Do not twist the seat belt while it is fastened.
- Once the seat belt is positioned correctly, don't pull it away from your body with your hand.
- Do not lie the seat belt across rigid or fragile objects, e.g. glasses, pens or keys.
- Never use seat belt clips, retaining rings or similar instruments to alter the position of the belt webbing.

### Note

If your physical constitution prevents you from maintaining the correct position of the belt webbing, contact a specialised workshop for help with any special devices to ensure the optimum protection of the seat belt and airbag. SEAT recommends taking your car in for technical service.

## Seat belt tensioners

### How the seat belt tensioner works

The seat belts for the front and rear occupants are fitted with belt tensioners.

The belt tensioners are activated by sensors, although only in severe head-on, lateral and

rear-end collisions. This retracts and tightens the seat belts, reducing the forward motion of the occupants.

The belt pre-tensioners work in combination with the airbag system. In case of overturn, the pre-tensioners do not activate unless the head airbags are deployed.

### Belt tension limiter

The belt tension limiter reduces the force of the seat belt on the body in the event of an accident.

### Note

- If the seat belt tensioners are triggered, a fine dust is produced. This is normal and it is not an indication of fire in the vehicle.
- The relevant safety requirements must be observed when the vehicle or components of the system are scrapped. Specialised workshops are familiar with these regulations, which are also available to you.

### Maintenance and disposal of seat belt tensioners

The belt tensioners are components of the seat belts that are installed in the seats of your vehicle. If you work on the belt tensioners or remove and install parts of the system when performing other repair work, the seat

belt may be damaged. The consequence may be that, in the event of an accident, the belt tensioners function incorrectly or may not function at all.

So that the effectiveness of the seat belt tensioner is not reduced and that removed parts do not cause any injuries or environmental pollution, regulations, which are known to the specialised workshops, must be observed.

### WARNING

- Improper use or repairs not carried out by qualified mechanics increase the risk of severe or fatal injuries. The belt tensioners may fail to trigger or may trigger in the wrong circumstances.
- The seat belt tensioner, seat belt and automatic retractor cannot be repaired.
- Any work on the belt tensioners and seat belts, including the removal and refitting of system parts in conjunction with other repair work, must be performed by a specialised workshop only.
- The belt tensioners will only provide protection for one accident and must be changed if they have been activated.

### For the sake of the environment

Airbag modules and belt tensioners may contain perchlorate. Observe the legal requirements for their disposal.

## Airbag system

### Brief introduction

#### Why is it so important to wear a seat belt and to sit correctly?

For the inflating airbags to achieve the best protection, the seat belt must always be worn properly and the correct sitting position must be assumed.

The airbag system is not a substitute for seat belts, but it is an integral part of the vehicle's overall passive safety system. Please bear in mind that the airbag system can only work effectively when the vehicle occupants are wearing their seat belts correctly and have adjusted the head restraints properly. Therefore, it is most important to properly wear the seat belts at all times, not only because this is required by law in most countries, but also for your safety »» page 14, **The whys and wherefores of seat belts.**

The airbag inflates in a matter of seconds, so if you are not properly seated when the airbag is triggered, you may sustain fatal injuries. Therefore, it is essential that all vehicle occupants assume a correct sitting position while travelling.

Sharp braking before an accident may cause a passenger not wearing a seat belt to be

thrown forward into the area of the deploying airbag. In this case, the inflating airbag may inflict critical or fatal injuries on the occupant. This also applies to children.

Always maintain the greatest possible distance between yourself and the front airbag. This way, the front airbags can completely deploy when triggered, providing their maximum protection.

The most important factors for triggering the airbag are the type of accident, the angle of impact and the vehicle speed.

Whether or not the airbags are triggered depends primarily on the vehicle deceleration rate resulting from the collision and detected by the control unit. If the vehicle deceleration occurring during the collision and measured by the control unit remains below the specified reference values, the front, side and/or curtain airbags will not be triggered. Take into account that the visible damage in a vehicle involved in an accident, no matter how serious, is not a determining factor for the airbags to have been triggered.

#### WARNING

- **Wearing the seat belt incorrectly or assuming an incorrect sitting position can lead to critical or fatal injuries.**
- **All vehicle occupants, including children, who are not properly belted can sustain critical or fatal injuries if the airbag is trig-**

**gered. Children up to 12 years old should always travel on the rear seat. Never transport children in the vehicle if they are not restrained or the restraint system is not appropriate for their age, size or weight.**

- **To reduce the risk of injury from an inflating airbag, always wear the seat belt properly »» page 14.**

### Description of the airbag system

The airbag system offers additional protection for the occupants in combination with the seat belts.

**The airbag system comprises the following modules (as per vehicle equipment):**

- Electronic control unit
- Front airbags for driver and passenger
- Side airbags for driver and passenger.
- Head airbag
- Airbag control lamp  on the instrument panel »» page 22
- Key-operated switch for front passenger airbag
- Control lamp for disabled/enabled status of the front passenger airbag.

The airbag system operation is monitored electronically. The airbag control lamp will illuminate for a few seconds every time the ignition is switched on (self-diagnosis).

### There is a fault in the system if the control lamp :

- does not light up when the ignition is switched on »» page 22.
- turns off after 4 seconds after the ignition is switched on,
- turns off and then lights up again after the ignition is switched on,
- illuminates or flashes while the vehicle is moving.

### The airbag system is not triggered if:

- the ignition is switched off
- there is a minor frontal collision
- there is a minor side collision
- there is a rear-end collision
- the vehicle turns over.

### WARNING

- **The seat belts and airbags can only provide maximum protection if the occupants are seated correctly »» page 11.**
- **If a fault has occurred in the airbag system, have the system checked immediately by a specialised workshop. Otherwise there is a danger that during a collision, the**

**system may fail to trigger, or not trigger correctly.**

### Airbag activation

The airbags deploy extremely rapidly, within thousands of a second, to provide additional protection in the event of an accident. A fine dust may develop when the airbag deploys. This is normal and it is not an indication of fire in the vehicle.

The airbag system is only ready to function when the ignition is on.

In special accidents instances, several airbags may activate at the same time.

In the event of minor head-on and side collisions, rear-end collisions, overturning or roll-over of the vehicle, airbags **do not activate**.

### Activation factors

The conditions that lead to the airbag system activating in each situation cannot be generalised. Some factors play an important role, such as the properties of the object the vehicle hits (hard/soft), angle of impact, vehicle speed, etc.

Deceleration trajectory is key for airbag activation.

The control unit analyses the collision trajectory and activates the respective restraint system.

If the deceleration rate is below the predefined reference value in the control unit the airbags will not be triggered, even though the accident may cause extensive damage to the car.

### The following airbags are triggered in serious head-on collisions:

- Driver airbag.
- Front passenger front airbag

### The following airbags are triggered in serious side-on collisions:

- Front side airbag on the side of the accident.
- Curtain (head) airbag on the side of the accident.

### In an accident with airbag activation:

- the interior lights switch on (if the interior light switch is in the courtesy light position);
- the hazard warning lights switch on;
- all doors are unlocked;
- the electric current supply to the motor is cut off.

## Operation of the airbags

### Airbag system control lamps



#### It lights up on the combi-instrument

Fault in the airbag system and seat belt tensioners. Have the system checked immediately by a specialised workshop.





#### It lights up on the instrument panel



Fault in the airbag system. Have the system checked immediately by a specialised workshop.

Front passenger front airbag deactivated. Check if the airbag should be kept deactivated

Several warning and control lamps light up for a few seconds when the ignition is switched on, signalling that the function is being verified. They will switch off after a few seconds.

If the airbag and seat belt tensioner system control lamp  remains on or flashes, it indicates a malfunction in the airbag and seat belt tensioner system . Have the system checked immediately by a specialised workshop.

If the front passenger airbag is deactivated, the lamp **PASSENGER AIR BAG OFF**  does not re-

main lit, or if it is lit together with the control lamp  on the instrument panel, there may be a fault in the airbag system .

### ⚠ WARNING

In the event of a fault in the airbag and seat belt tensioner system, the airbags and seat belts may not trigger correctly, may fail to trigger or may even trigger unexpectedly.

- The vehicle occupants run the risk of sustaining severe or fatal injuries. Have the system checked immediately by a specialised workshop.
- Do not mount a child seat in the front passenger seat or remove the mounted child seat! The front passenger front airbag may deploy during an accident in spite of the fault.

### ⓘ CAUTION

Always pay attention to any lit control lamps and to the corresponding descriptions and instructions to avoid damage to the vehicle or harm to the occupants.

### Front airbags

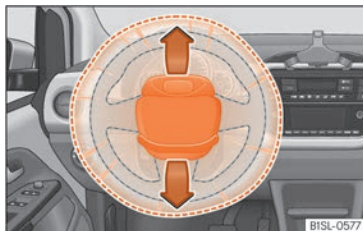

**Fig. 13** Driver airbag located in steering wheel.

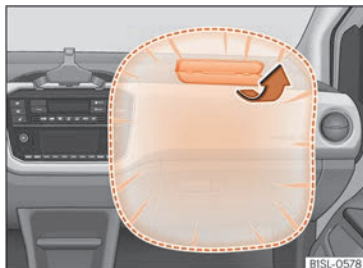

**Fig. 14** Front passenger airbag located in instrument panel.

The driver's front airbag is housed in the steering wheel and that of the front passenger, on the instrument panel. Airbags are identified by the word "AIRBAG".



The airbag covers fold open and remain attached to the steering wheel » Fig. 13 and the dash panel » Fig. 14 when the driver and front passenger airbags, respectively, are triggered.

In conjunction with the seat belts, the front airbag system gives the front occupants additional protection for the head and chest in the event of a severe frontal collision » ⚠.

Their special design allows the controlled escape of the propellant gas when an occupant puts pressure on the bag. Thus, the head and chest are protected by the airbag. After the collision, the airbag deflates sufficiently to allow visibility.

#### ⚠ WARNING

- The deployment space between the front passengers and the airbags must not in any case be occupied by other passenger, pets and objects.
- The airbags provide protection for just one accident; replace them once they have deployed.
- It is also important not to attach any objects such as cup holders or telephone mountings to the surfaces covering the airbag units.

### Activate and deactivate front passenger front airbag



Fig. 15 Switch for activating and deactivating the front passenger airbag.

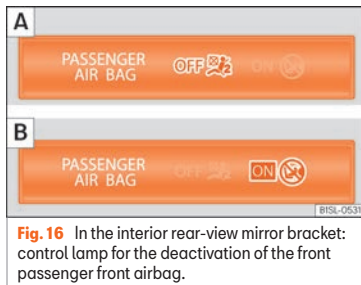

Fig. 16 In the interior rear-view mirror bracket: control lamp for the deactivation of the front passenger front airbag.

Deactivate the front passenger front airbag only if you have to use a rear-facing child seat in the front passenger seat.

SEAT recommends fitting the child seat in the rear seat to avoid having to deactivate the front passenger airbag.

When the front passenger airbag is **deactivated**, this means that only the front passenger front airbag is deactivated. All the other airbags in the vehicle remain activated.

### Deactivate and activate the front passenger front airbag

- Switch the ignition off.
- Open the door on the front passenger side.
- Insert the key into the slot of the switch for deactivating the front passenger airbag » Fig. 15. About 3/4 of the key should enter; this is as far as it will go.
- Turn the key gently to change its position to **OFF** (deactivate) or to **ON** (activate). If you have difficulty, ensure that you have inserted the key as far as it will go.
- Close the front passenger door.
- When deactivating the airbag, check that when the ignition is switched on, the control lamp **OFF** ⚡; lights up the lettering **PASSENGER AIR BAG OFF** ⚡; on the interior rear-view mirror bracket » Fig. 16.
- When reactivating the airbag, check that when the ignition is switched on, the **OFF** ⚡; »

**⚠ WARNING**

- The driver of the vehicle is responsible for ensuring that the passenger airbag is switched off or on.
- Always switch off the ignition before disabling the front passenger airbag! Failure to do so could result in a fault in the airbag deactivation system.
- Never leave the key in the airbag disabling switch as it could get damaged or enable or disable the airbag during driving.
- If for any reason an airbag is deactivated, reactivate it as soon as possible so that it can fulfil its protective function.

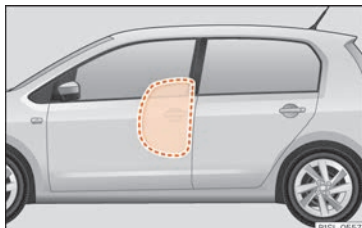
**Side airbags****Fig. 17** Side airbag in driver's seat.**Fig. 18** Illustration of completely inflated side airbag on left side of vehicle.

The side airbags are located in the driver's seat and front passenger seat backrests

»» **Fig. 17.**

The locations are identified by the text "AIR-BAG" in the upper region of the backrests.

In conjunction with the seat belts, the side airbag system provides additional protection for the upper body in the event of a severe side collision »» **⚠.**

In a side collision, the side airbags reduce the risk of injury to passengers to the areas of the body facing the impact. In addition to their normal protection, the seat belts also hold the passengers in the event of a side collision; this is how these airbags provide maximum protection.

**⚠ WARNING**

- If you do not wear a seat belt, if you lean forward, or are not seated correctly while the vehicle is in motion, you are at a greater risk of injury if the side airbag system is triggered in an accident.
- In order for the side airbags to provide their maximum protection, the prescribed sitting position must always be maintained with seat belts fastened while travelling.
- In a side-on collision the side airbags will not work if the sensors do not correctly measure the pressure increase on the interior of the doors, due to air escaping through the areas with holes or openings in the door panel.
- Never drive if the interior door panels have been removed or if the panels have not been correctly fitted.
- Never drive the vehicle if the loudspeakers in the door panels have been removed, unless the holes left by the loudspeakers have been closed properly.
- Always check that the openings are closed or covered if loudspeakers or other equipment are fitted inside the door panels.
- Occupants of the outer seats must never carry any objects or pets in the deployment space between them and the airbags, or allow children or other passengers to travel in this position. It is also important not to attach any accessories (such as cup

holders] to the doors. This would impair the protection offered by the side airbags.

- The built-in coat hooks should be used only for lightweight clothing. Do not leave any heavy or sharp-edged objects in the pockets.
- Great forces, such as hard blows or kicks, must not be exerted upon the backrest bolster because the system may be damaged. In this case, the side airbags would not be triggered.
- Under no circumstances should protective covers be fitted over seats with side airbags unless the covers have been approved for use in your vehicle. Because the airbag deploys from the side of the backrest, the use of conventional seat covers would obstruct the side airbag, seriously reducing the airbag's effectiveness.
- Any damage to the original seat upholstery or around the seams of the side airbag units must be repaired immediately by a specialised workshop.
- The airbags provide protection for just one accident; replace them once they have deployed.
- Any work on the side airbag system or removal and installation of the airbag components for other repairs (such as removal of the front seat) should only be performed by a specialised workshop. Otherwise, faults may occur during the airbag system operation.

## Head-protection airbags\*



**Fig. 19** Location and deployment area of the head-protection airbag.

The head-protection airbags are located on both sides in the interior above the doors » **Fig. 19** and are identified with the text "AIR-BAG".

In conjunction with the seat belts, the head-protection airbag system gives the vehicle occupants additional protection for the head and upper body in the event of a severe side collision » **⚠**.

The area framed in red is covered by the head-protection airbag when it is deployed » **Fig. 19** [deployment area]. Therefore, objects should never be placed or mounted in this area » **⚠**.

In the event of a side collision the curtain airbag is triggered on the impact side of the vehicle.

The head-protection airbags reduce the risk of injury to passengers in the front and rear side seats facing the impact.

## **⚠ WARNING**

- In order for the head-protection airbags to provide their maximum protection, the prescribed sitting position must always be maintained with seat belts fastened while travelling.
- For safety reasons, the curtain airbag must be disabled in those vehicles fitted with a screen dividing the interior of the vehicle. See your technical service to make this adjustment.
- There must be no other persons, animals or objects between the occupants of the outer seats and the deployment space of the head-protection airbags so that the head-protection airbag can deploy completely without restriction and provide the greatest possible protection. Therefore, sun blinds which have not been expressly approved for use in your vehicle may not be attached to the side windows.
- The built-in coat hooks should be used only for lightweight clothing. Do not leave any heavy or sharp-edged objects in the pockets. Please, do not hang the clothes on coat hangers.
- The airbags provide protection for just one accident; replace them once they have deployed. »

- Any work on the head-protection airbag system or removal and installation of the airbag components for other repairs (such as removal of the roof lining) should only be performed by a specialised workshop. Otherwise, faults may occur during the airbag system operation.
- The side and head airbags are managed through sensors located in the interior of the front doors. To ensure the correct operation of the side and curtain airbags neither the doors nor the door panels should be modified in any way (e.g. fitting loudspeakers). If the front door is damaged, the airbag system may not work correctly. All work carried out on the front door must be done in a specialised workshop.

## Transporting children safely

### Safety for children

#### Introduction

For safety reasons, as we have learned from accident statistics, we recommend that children under 12 years of age travel in the rear seats. Depending on their age, height and weight, children travelling in rear seats must use a child seat or a seat belt. For safety reasons, the child seat should be installed in the rear seat, behind the front passenger seat or in the centre back seat.

The physical laws involved and the forces acting in a collision apply also to children »» page 16. But unlike adults, children do not have fully developed muscle and bone structures. This means that children are subject to a greater risk of injury.

To reduce the risk of injuries, children must always use special child restraint systems when travelling in the vehicle.

We recommend the use of child safety products from the SEAT Original Accessories Programme, which includes systems for all ages made by "Peke" (not for all countries) (see [www.seat.com](http://www.seat.com)).

These systems have been especially designed and approved, complying with the ECE-R44. regulation.

SEAT recommends securing the child seats shown on the website as described below:

- Child seats in the opposite direction of travel (group 0+): ISOFIX and support foot (RÖMER BABY SAFE PLUS SHR II + ISOFIX BASE / PEKE GO I-SIZE + I-SIZE BASE).
- Child seats in the direction of travel (group 1): ISOFIX and Top Tether (RÖMER DUO PLUS + TOP TETHER / PEKE G1 TRIFIX I-SIZE).
- Child seats facing the direction of travel (group 2): safety belt and ISOFIX (RÖMER KIDFIX XP).
- Child seats facing the direction of travel (group 3): safety belt and ISOFIX (RÖMER KIDFIX XP).

Follow the manufacturer's instructions and observe any statutory requirements when installing and using child seats. Always read and note »» page 28.

We recommend you always carry the manufacturer's Child Seat Instruction Manual together with the on-board documentation.

### Child seats group classification



**Fig. 20** Examples of child seats.

Use only child seats that are officially approved and suitable for the child.

Child seats are subject to the regulation ECE-R 44 or ECE-R 129. ECE-R stands for: Economic Commission for Europe Regulation.

#### Child seats by weight group

The child seats are grouped into 5 categories:

Age group	Weight of the child
Group 0	Up to 10 kg
Group 0+	Up to 13 kg
Group 1	From 9 to 18 kg
Group 2	From 15 to 25 kg
Group 3	From 22 to 36 kg

Child seats that have been tested and approved under the ECE-R 44 or ECE-R 129 standard bear the test mark ECE-R 44 or ECE-R 129 on the seat (the letter E in a circle with the test number below it).

Follow the manufacturer's instructions and observe any statutory requirements when installing and using child seats.

We recommend you to always include the manufacturer's Child Seat Instruction Manual together with the on-board documentation.

SEAT recommends you use child seats from the **Original Accessories Catalogue**. These child seats have been designed and tested for use in SEAT vehicles. You can find the right child seat for your model and age group at SEAT dealers.

#### Child seats by approval category

Child seats may have the approval category of universal, semi-universal, vehicle specific (all according to the ECE-R 44 standard) or i-Size (according to the ECE-R 129 standard).

- **Universal:** child seats with universal approval can be installed in all vehicles. There is no need to consult any list of models. In the case of universal approval for ISOFIX, the child seat is additionally provided with a Top Tether belt.
- **Semi-universal:** semi-universal approval, in addition to the standard requirements of

universal approval, requires safety devices to lock the child seat, which require additional testing. Child seats with semi-universal approval include a list of vehicle models for which they can be installed.

- **Vehicle-specific:** vehicle-specific approval requires a dynamic test of the child seat for each vehicle model separately. Child seats with vehicle-specific approval also include a list of vehicle models for which they can be installed.
- **i-Size:** child seats with i-Size approval must meet the requirements prescribed in the ECE-R 129 standard in relation to installation and safety. Child seat manufacturers can tell you which seats have i-Size approval for this vehicle.

## Fitting and using child seats



**Fig. 21** Airbag sticker: on the passenger's sun visor



**Fig. 22** Airbag sticker: on the rear frame of the passenger side door

### Warnings about fitting a child seat

Take the following general warnings into account if you are going to fit a child seat. They are valid for all child seats regardless of their attachment system.

- Please read and follow the child seat manufacturer's operating instructions.
- The child seat should preferably be fitted to the rear seat behind the front passenger seat so that the child can exit the vehicle on the pavement side.
- Set the height of the seat belt such that it adapts to the child seat naturally, without twisting. The lowest position of the seat belt height regulator must be used with rear-facing child seats.
- To correctly use a child seat in the back, the front backrest must be adjusted so that there is no contact with the child seat in the back in the case that it goes opposite to the direction of the car. In the case of front facing restraint systems, the front backrest must be adjusted so that there is no contact with the child's feet.
- If a semi-universal type chair is to be installed, in which the method of attachment to the car is through the seat belt and support

bracket, it should never be installed in the central rear seat as the ground clearance is lower than in other places and the support bracket will not allow the seat to remain sufficiently stable.

- When fitting a child seat on the front passenger seat, the seat must be moved backwards as far as possible and placed in the highest position. The backrest must also be put in a vertical position<sup>1)</sup>.

### Important information about the front passenger front airbag

A sticker with important information about the passenger airbag is located on the passenger's sun visor and/or on the passenger side door frame »» **Fig. 21**.

Read and always observe the safety information included in the following chapters:

- Safety distance with respect to the passenger airbag »» **page 20**.
- Objects between the passenger and the passenger side airbag »» **△ in Front airbags on page 23**.

The passenger side front airbag, when enabled, is a serious risk for a child that is facing backward since the airbag can strike the seat

<sup>1)</sup> Compliance with current national legislation and the manufacturer's instructions is required when using or installing child seats.

with such force that it can cause serious or fatal injuries. Children up to 12 years old should always travel on the rear seat.

Therefore we strongly recommend you to transport children on the rear seats. This is the safest location in the vehicle. Alternatively, the front passenger airbag can be disabled with a key-operated switch »» page 23. When transporting children, use a child seat suitable for the age and size of each child »» page 27.

### WARNING

- If a child seat is secured to the front passenger seat, the risk to the child of sustaining critical or fatal injuries in the event of an accident increases.
- An inflating front passenger airbag can strike the rear-facing child seat and project it with great force against the door, the roof or the backrest.
- Never install a child seat facing backwards on the front passenger seat unless the front passenger front airbag has been disabled. Risk of potentially fatal injuries to the child! However, if necessary, the front passenger front airbag must be deactivated »» page 23. If the passenger seat has a height adjustment option, move it to the highest, most upright position. If you have a fixed seat, do not install any child restraint system in this location.

- For those vehicles that do not include a key lock switch to deactivate the airbag, the vehicle must be taken to a technical service. Do not forget to reconnect the airbag when an adult wants to sit in the front passenger seat.
- Never allow a child to be transported in a vehicle without being properly secured, or to stand up or kneel on a seat while travelling. In an accident, the child could be flung through the vehicle, causing possibly fatal injuries to themselves and to the other vehicle occupants.
- Never leave a child alone in the child seat or in the vehicle.
- Children who are less than 1.5 metres tall must not wear a normal seat belt without a child seat, as this could cause injuries to the abdominal and neck areas during a sudden braking manoeuvre or in an accident.
- When a child seat is mounted in the rear seats, the door child-proof lock should be activated »» page 73.

### Attachment systems

Depending on the country, different attachment systems are used for safely installing child seats.

### Attachment systems overview

• **ISOFIX:** ISOFIX is a standardised attachment system allowing quick and safe attachment of child seats in the vehicle. ISOFIX attachment establishes a rigid connection between the child seat and the car body.

The child seat has two rigid attachment clips, called connectors. These connectors are fitted into the ISOFIX attachment rings found between the seat cushion and the backrest of the vehicle's back seat (on the sides). ISOFIX attachment systems are used mainly in Europe »» page 30. If necessary, ISOFIX attachment may have to be supplemented with a Top Tether belt or a support bracket.

• **Automatic three-point seat belt.** Whenever possible, it is preferable to attach the child seats with the ISOFIX system rather than attaching them with an automatic three-point seat belt »» page 33.

Additional attachment:

• **Top Tether:** the Top Tether belt is guided over the back of the rear seat and attached to an anchor point with a hook. Anchor points are located at the back of the rear seat backrest on the boot side »» page 32. The rings for retaining the Top Tether belt are marked with an anchor symbol.

• **Support bracket:** some child seats rest on the floor of the vehicle with a support bracket. The support bracket prevents the child seat »»

from tipping forward in the event of impact. Child seats fitted with a support bracket should only be used in the passenger seat and side rear seats » » » ⚠. For the assembly of this type of seat you should also consult the list of approved vehicles for this assembly, available in the instructions for child restraint systems.

### Recommended systems for attaching child seats

SEAT recommends attaching child seats as follows:

- **Baby carriers or child seats in the opposite direction of travel:** ISOFIX and support bracket or i-Size.

- **Child seats in the direction of travel:** ISOFIX and Top Tether.

### ⚠ WARNING

Incorrect use of the support bracket can cause serious or fatal injury.

- **Make sure the support bracket is correctly and safely installed.**

## Fit a child seat with the ISOFIX / i-Size and Top Tether\* system



**Fig. 23** Rear seat: ISOFIX/i-Size securing rings.

Child seats can be secured quickly, easily and safely on the rear seats with the ISOFIX/i-Size\* and Top Tether system.

Two "ISOFIX" retaining rings are fitted on each rear side seat. The "ISOFIX" rings are located

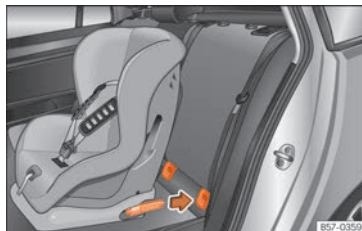

**Fig. 24** Rear seats: fitting a child seat with the ISOFIX system.

between the rear seat backrest and the seat cushioning » » » **Fig. 23**. The Top Tether\* rings are located on the rear part of the backrests of the rear seats (behind the seat backrest or in the boot) » » » **page 32**.

To understand the compatibility of the ISOFIX/i-Size systems in the vehicle, check the table below.



Age group	Class according to size <sup>a1</sup>	Front passenger seat	Rear seats
Group 0: up to 10 kg	E	X	IL-SU
Group 0+: up to 13 kg	E	X	IL-SU
	D	X	
	C	X	
Group 1: 9 to 18 kg	D	X	IL-SU IUF
	C	X	
	B	X	
	B1	X	
	A	X	
Group 2: 15 to 25 kg	-	X	IL-SU
Group 3: 22 to 36 kg	-	X	IL-SU
i-Size child restraint system	-	X	i-U

**X:** space not suitable for fixing an ISOFIX or i-Size child seat in this group.

**IL-SU:** space suitable for installing an ISOFIX child seat with semi-universal approval. Take the child seat manufacturer's vehicle list into account.

**IUF:** suitable place for installing an ISOFIX child seat with universal approval.

**i-U:** space suitable for fitting a forward- or rear-facing i-Size child seat with universal approval.

**i-UF:** space suitable for fitting a forward-facing i-Size child seat with universal approval.

<sup>a1</sup> The indication of class according to size corresponds to the authorised bodyweight for the child seat. In child seats with universal or semi-universal approval, the class according to size is indicated on the ECE approval label. The indication of class according to size is stated on the corresponding child seat.

### Securing the child seat with the "ISOFIX/i-Size" system

You are obliged to follow the seat manufacturer's instructions.

- Press the child seat onto the "ISOFIX/iSize" retaining rings until the child seat is heard to engage securely »» Fig. 24. If the child seat is equipped with Top Tether\* anchor points, secure it to the correspondent ring »» page 32. Observe the manufacturer's instructions.

- Pull on both sides of the child seat to ensure that it is properly anchored.

Child seats with the "ISOFIX" and Top Tether\* attachment system are available from Technical Services. »

### **⚠ WARNING**

The retaining rings are designed only for use with "ISOFIX" and Top Tether\* system child seats.

- Never secure other child seats that do not have the "ISOFIX" or Top Tether\* system, or retaining belts or objects to the fastening rings - this can result in potentially fatal injuries to the child.
- Ensure that the child seat is secured correctly using the "ISOFIX" and Top Tether\* securing rings.

### **Top Tether\* securing belts**

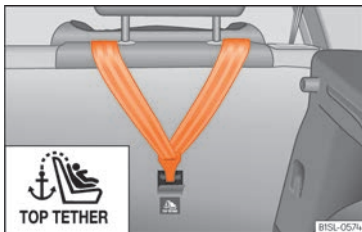

**Fig. 25** Back of the rear seats: Top Tether ring concealed underneath a cut in the carpet.

Child seats with the Top Tether system come with a strap for securing the seat to the vehicle anchor point, located at the back of the rear seat backrest and provide greater restraint.

The objective of this strap is to reduce forward movements of the child seat in a crash, to reduce the risk of injuries to the head from hitting the inside of the vehicle.

### **Using the Top Tether in rear-facing mounted seats**

Currently, there are very few rear-facing child safety seats that have Top Tether. Please carefully read and follow the seat manufacturer instructions to learn the proper way to install the Top Tether strap.

### **Securing the retainer strap**

- Follow the manufacturer's instructions to deploy the child seat Top Tether retaining strap.
- Place the belt under the headrest of the back seat (depending on the instructions of the chair itself, lift or remove the headrest if necessary).

- Slide the strap and secure it properly with the anchorage of the backrest »» Fig. 25.
- Firmly tighten the strap following the manufacturer's instructions.

### **Releasing the retaining strap**

- Loosen the strap following the manufacturer's instructions.
- Push the lock and release it from the anchoring support.

### **⚠ WARNING**

An undue installation of the safety seat will increase the risk of injury in the event of a crash.

- Never tie the retainer strap to a hook in the luggage compartment.
- Never secure or tie luggage or other items to the lower anchorages (ISOFIX) or the upper ones (Top Tether).

## Fitting a child seat using the seat belt

If you want to fit a universal approval category (U) child seat in your vehicle, you must check that the seat is approved for your vehi-

cle. You will find any necessary information on the child seat's orange ECE approval la-

bel. The following table shows the different fitting options.

Age group		Weight of the child	Front passenger seat		Rear seats
			Front passenger air-bag activated	Front passenger air-bag deactivated	
Group 0		Up to 10 kg	X	U	U
Group 0+		Up to 13 kg	X	U	U
Group 1	Rear-facing	From 9 to 18 kg	X	U	U
	Forward-facing	From 9 to 18 kg	U	X	U
Group 2		From 15 to 25 kg	U	X	U
Group 3		From 22 to 36 kg	U	X	U

U: universal.

X: vehicle seat unsuitable for fitting this group of child seat.

### Fitting a child seat using the seat belt

- Set the height of the seat belt such that it adapts to the child seat naturally, without twisting. The lowest position of the seat belt height regulator must be used with rear-facing child seats.
- Put the seat belt in place and pass it through the child seat according to the instructions of the child seat manufacturer.
- Make sure that the seat belt is not twisted.

- Insert the latch plate into the seat's buckle until you hear the engagement click.

#### WARNING

**When travelling, children must be secured in the vehicle with a restraint system suitable for age, weight and size.**

- **Read and always observe information and warnings concerning the use of child seats»» page 28.**

# Emergencies

## Self-help

### Emergency equipment

#### First aid kit, warning triangle and fire extinguishers\*

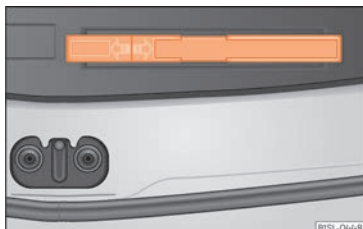

**Fig. 26** In the luggage compartment: warning triangle.

#### Warning triangle

The use of reflective warning triangles is obligatory in emergencies in some countries. As are the first aid kit and a set of spare light bulbs.

Depending on the vehicle's equipment, the warning triangle can be found in a compartment located under the floor panel of the

load area in the luggage compartment  
»» Fig. 26.

#### First aid kit

The first aid kit must comply with legal requirements. Check the expiry date of the contents of the first aid kit.

#### Fire extinguisher

A fire extinguisher can be stored in a holder in the passenger seat footwell.

The fire extinguisher must conform to legal requirements, be ready for use and be checked regularly. Check the certification seal on the extinguisher.

#### **⚠ WARNING**

Loose objects in the vehicle interior can be violently thrown in case of a sudden manoeuvre or braking and especially in accidents causing serious injury.

- Secure or store fire extinguishers, first aid kit, reflective vests and warning triangle securely in the vehicle.

#### **i Note**

- The first aid kit, warning triangle, reflective vests and fire extinguishers are not part of the vehicle's standard equipment.
- The warning triangle should meet legal requirements.

- Before acquiring accessories and emergency equipment see the instructions in "Accessories and spares" »» page 202.

### Vehicle tool kit

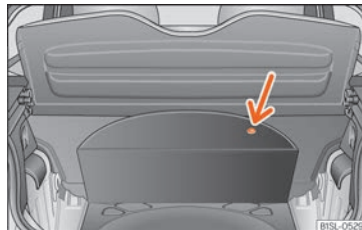

**Fig. 27** In the luggage compartment: carpet raised.

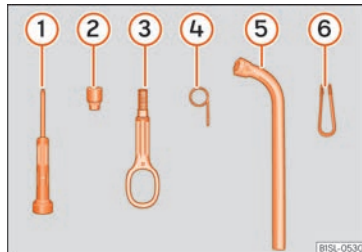

**Fig. 28** Underneath the floor panel of the luggage compartment: vehicle tool kit.

The vehicle tool kit is located under the floor panel in the luggage compartment »» Fig. 27. To access the vehicle tools »» page 90.

The tool kit includes:

- ① Screwdriver with hexagon socket in the handle for screwing and unscrewing the wheel nuts
- ② Adapter for the anti-theft bolt
- ③ Towing eye, removable
- ④ Hook for extracting the central wheel trims\*
- ⑤ Wheel spanner
- ⑥ Clip for removing the wheel bolt caps

Some of the items listed are only provided in certain model versions, or are optional extras.

#### WARNING

If loose, the vehicle tool kit and anti-puncture kit could be thrown violently in the passenger compartment in case of sudden manoeuvres, sudden braking and accidents, and could cause serious injuries.

- Always check that the vehicle tool kit and the anti-puncture kit are securely fastened in the luggage compartment.

#### WARNING

Unsuitable or damaged vehicle tools can cause injury or accidents.

- Never work with inappropriate or damaged tools.

## Tyre repairs

### TMS (Tyre Mobility System)\*

The Anti-puncture kit \* (Tyre Mobility System) will reliably seal punctures caused by the penetration of a foreign body of up to about 4 mm in diameter. **Do not remove foreign objects, e.g. screws or nails, from the tyre.**

After inserting the sealant residue in the tyre, you must again check the tyre pressure about 10 minutes after starting the engine.

You should only use the tyre mobility set if the vehicle is parked in a safe place, you are familiar with the procedure and you have the necessary tyre mobility set! Otherwise, you should seek professional assistance.

**Do not use the tyre sealant in the following cases:**

- If the wheel rim has been damaged.
- In outside temperatures below -20°C [-4°F].
- In the event of cuts or perforations in the tyre greater than 4 mm.
- If you have been driving with very low pressure or a completely flat tyre.

- If the sealant bottle has passed its use by date.

#### WARNING

Using the tyre mobility system can be dangerous, especially when filling the tyre at the roadside. Please observe the following rules to minimise the risk of injury:

- Stop the vehicle safely as soon as possible. Park it at a safe distance from surrounding traffic to fill the tyre.
- Ensure the ground on which you park is flat and solid.
- All passengers and particularly children must keep a safe distance from the work area.
- Turn on the hazard warning lights to warn other road users.
- Use the tyre mobility system only if you are familiar with the necessary procedures. Otherwise, you should seek professional assistance.
- The tyre mobility set is intended for temporary emergency use only until you can reach the nearest specialised workshop.
- Replace the repaired tyre with the tyre mobility set as soon as possible.
- The sealant is a health hazard and must be cleaned immediately if it comes into contact with the skin.
- Always keep the tyre mobility set out of the reach of small children.

»

- Always stop the engine, apply the hand brake and put it in gear when using a manual gearbox, in order to reduce the risk of involuntary movement of the vehicle.

### **WARNING**

A tyre filled with sealant does not have the same performance properties as a conventional tyre.

- Never drive faster than 80 km/h (50 mph).
- Avoid heavy acceleration, hard braking and fast cornering.
- Drive for only 10 minutes at a maximum speed of 80 km/h (50 mph) and then check the tyre.

### **For the sake of the environment**

Dispose of used or expired sealant observing any legal requirements.

### **Note**

A new bottle of sealant can be purchased at SEAT dealerships.

### **Note**

Take into account the separate instruction manual of the tyre mobility set \* manufacturer.

### Anti-puncture kit contents\*

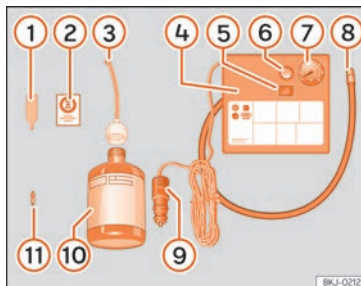

**Fig. 29** Standard representation: anti-puncture kit contents.

The anti-puncture kit is located underneath the floor covering in the luggage compartment. It includes the following components

»» **Fig. 29:**

- 1 Valve insert remover
- 2 A sticker to be adhered to the instrument cluster, within the driver's visual field, to remind that the maximum advisable speed "max. 80 km/h" or "max. 50 mph"
- 3 Filler tube with cap
- 4 Air compressor
- 5 ON/OFF switch
- 6 Air bleed screw (it can also be integrated in the inflator tube).

7 Warning provided by tyre pressure monitoring system (it can also be integrated in the inflator tube).

- 8 Tube for inflating tyres
- 9 12 volt connector
- 10 Bottle of sealant
- 11 Spare tyre valve

The **valve insert remover** 1 has a gap at the lower end for a valve insert. The valve insert can only be screwed or unscrewed in this way. This also applies to its replacement part 11.

### Sealing and inflating a tyre

#### Sealing the tyre

- Unscrew the tyre valve cap and insert. Use the »» **Fig. 29** 1 tool to remove the insert. Place it on a clean surface.
- Shake the tyre sealant bottle vigorously »» **Fig. 29** 10.
- Screw the inflator tube »» **Fig. 29** 8 into the sealant bottle. The bottle's seal will break automatically.
- Remove the lid from the filling tube »» **Fig. 29** 3 and screw the open end of the tube into the tyre valve.
- With the bottle upside down, empty **all** of the contents into the tyre.

- Remove the bottle from the valve.
- Place the insert back into the tyre valve using the tool »» Fig. 29 ①.

### Inflating the tyre

- Screw the compressor tyre inflator tube »» Fig. 29 ⑧ into the tyre valve.
- Check that the air bleed screw is closed »» Fig. 29 ⑥.
- Connect the vehicle's drive system.
- Insert the connector »» Fig. 29 ⑨ into the vehicle's 12-volt socket »» page 97.
- Turn the air compressor on with the ON/OFF switch »» Fig. 29 ⑤.
- Keep the air compressor running until it reaches 2.0 to 2.5 bar (29-36 psi/200-250 kPa).

#### A maximum of 8 minutes.

- Disconnect the air compressor.
- If it does not reach the pressure indicated, unscrew the tyre inflator tube from the valve.
- Move the vehicle 10m so that the sealant is distributed throughout the tyre.
- Screw the compressor tyre inflator into the valve.
- Repeat the inflation process.
- If the indicated pressure still cannot be reached, the tyre is too badly damaged. Stop and request assistance from an authorised technician.

- Disconnect the air compressor. Unscrew the tyre inflator tube from the tyre valve.
- When the tyre pressure is between 2.5 and 2.0 bars, continue driving without exceeding 80 km/h (50 mph).
- Attach the sticker »» Fig. 29 ② to the instrument cluster, within the driver's visual field.
- Check the pressure again after 10 minutes »» page 37.

### ⚠ WARNING

When inflating the wheel, the air compressor and the inflator tube may become hot.

- Protect hands and skin from hot parts.
- Do not place the hot flexible inflator tube or hot air compressor on flammable material.
- Allow them to cool before storing the device.
- If it is not possible to inflate the tyre to at least 2.0 bars (29 psi / 200 kPa), the tyre is too badly damaged. The sealant is not in a good condition to seal the tyre. Do not continue driving. Seek specialist assistance.

### ⓘ CAUTION

Switch off the air compressor after a maximum of 8 operational minutes to avoid overheating! Before switching on the air compressor again, let it cool for several minutes.

### Check after 10 minutes of driving

Screw the inflator tube »» Fig. 29 ⑤ again and check the pressure on the gauge ⑥.

#### 1.3 bar (19 psi / 130 kPa) and lower:

- **Stop the vehicle!** The tyre cannot be sealed sufficiently with the tyre mobility set.
- You should obtain professional assistance »» ⚠.

#### 1.4 bar (20 psi / 140 kPa) and higher:

- Set the tyre pressure to the correct value again.
- Carefully resume your journey until you reach the nearest specialised workshop without exceeding 80 km/h (50 mph).
- Have the damaged tyre replaced.

### ⚠ WARNING

Driving with an unsealed tyre is dangerous and can cause accidents and serious injury.

- Do not continue driving if the tyre pressure is 1.3 bar (19 psi / 130 kPa) and lower.
- Seek specialist assistance.

## Changing a wheel

### What to do first

- Park the vehicle on a horizontal surface and in a safe place as far away from traffic as possible.
- Apply the handbrake.
- Switch on the hazard warning lights.
- Position the selector lever in **N** or **P**.
- Keep the vehicle tool kit »»» page 34 and the spare wheel\* available.
- Observe the applicable legislation for each country (reflective vest, warning triangles, etc.).
- All occupants should leave the vehicle and wait in a safe place (for instance behind the roadside crash barrier).

### ⚠ WARNING

- Always observe the above steps and protect yourself and other road users.
- If you change the wheel on a slope, block the wheel on the opposite side of the car with a stone or similar to prevent the vehicle from moving.

### Integral wheel trim



Fig. 30 Remove the wheel cover.

The wheel covers must be removed for access to the wheel bolts.

### Removing

- Take the wheel brace and the wire hook from the vehicle tool kit »»» page 34.
- Hook the wire through one of the grooves of the trim.
- Insert the box spanner through the hook, rest it on the tyre and remove the wheel trim »»» Fig. 30.

### Fitting

- Press the trim against the wheel so that the hole for the valve fits over the tyre valve.
- Make sure that the trim is correctly fitted all the way around the wheel. If you are using an

anti-theft wheel lock, screw it in the opposite position to the valve.

### Wheel bolt caps\*



Fig. 31 Wheel: wheel nuts with caps.

### Removal

- Fit the plastic clip (vehicle tools »»» Fig. 28) over the cap until it clicks into place »»» Fig. 31.
- Remove the cap with the plastic clip.

The caps protect the wheel bolts and should be remounted after changing the tyre.

The **anti-theft wheel locking bolt** has a special cap. This only fits on anti-theft locking bolts and is not for use with standard wheel bolts.



## Anti-theft wheel nuts

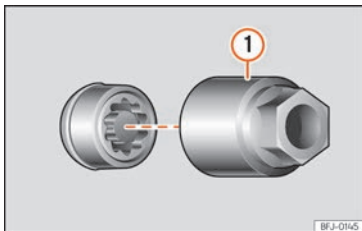

**Fig. 32** Anti-theft wheel bolt with cap and adapter.

### Loosening the anti-theft wheel bolt

- Remove the wheel cover\* or the cap\*.
- Insert the special adapter »» Fig. 32 ① (vehicle tools »» page 34) onto the anti-theft wheel bolt and push it on as far as it will go.
- Insert the wheel brace (vehicle tools) onto the adapter as far as it will go.
- Remove the wheel bolt »» page 39.

#### **i** Note

Make a note of the code number of the anti-theft wheel bolt and keep it in a safe place, but not in your vehicle. If you need a new adapter, you can obtain it from the SEAT Official Service, indicating the code number.

## Loosening wheel bolts



**Fig. 33** Wheel change: loosen the wheel nuts.

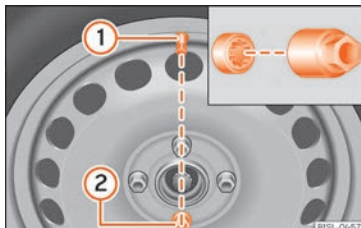

**Fig. 34** Wheel change: tyre valve ① and the correct position for the anti-theft wheel locking bolt ② or ③.

Use only the wheel wrench belonging to the car to loosen the wheel bolts.

Loosen the wheel bolts only about one turn before raising the vehicle with the jack.

If the wheel bolt is very tight, carefully push on the end of the wheel wrench with your foot. Hold on to the vehicle for support and take care not to slip during this operation.

### Loosening wheel bolts

- Fit the wheel wrench on as far as it will go »» Fig. 33.
- Hold the wrench at the end and rotate the bolt approximately *one* turn anticlockwise »» ⚠.

### Important information about wheel bolts

Factory-fitted rims and wheel bolts are specially matched during construction. Therefore, if different rims are fitted, the correct wheel bolts with the right length and heads must be used. This ensures that wheels are fitted securely and that the brake system functions correctly.

In certain circumstances, you should not even use wheel bolts from vehicles of the same model.

In wheels with full hubcaps, the anti-theft locking bolt must be threaded onto positions »» Fig. 34 ② or ③, taking the tyre valve's position as reference ①. Otherwise it will not be possible to mount the hubcap.

#### **⚠ WARNING**

If the wheel bolts are not properly tightened, they could come loose while driving »

and cause an accident, serious injury and loss of vehicle control.

- Use only wheel bolts which correspond to the rim in question.
- Never use different wheel bolts.
- Wheel bolts and threads should be clean, free of oil and grease, and it should be possible to screw them easily.
- To loosen and tighten wheel bolts, only use the wheel wrench that came with the car from the factory.
- The wheel bolts should only be loosened slightly (about one turn) before raising the vehicle with the jack. Risk of accident!
- Never apply grease or oil to wheel bolts or to the wheel hub threads. Even if the bolts have been tightened to the prescribed torque, they could come loose while driving.
- Never loosen the screwed joints of wheel rims with bolted ring trims.
- If wheel bolts are tightened below the prescribed torque, the bolts and rims could come loose while driving. If tightening torque is too high, the wheel bolts or threads can be damaged.

### Raise the vehicle



**Fig. 35** Jack position points.

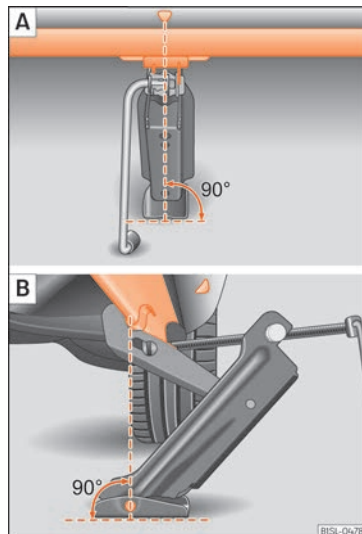

**Fig. 36** Cross member: positioning the jack on the vehicle.

- Rest the jack (vehicles tools) on firm ground. If necessary use a large, strong board or similar support. If the surface is slippery (for example tiles) place the jack on a rubber mat or similar to prevent it from slipping »» » ⚠.

- Find the support point on the strut (sunken area) closest to the wheel to be changed »» Fig. 35.
- Raise the jack with the crank handle until it can be inserted just below the support point of the vehicle.
- Make sure that the base of the jack rests firmly on the ground and that it is exactly below the vertical support point »» Fig. 36.
- Centre the jack and continue to raise it using the crank handle until the claw grasps the reinforcement located under the vehicle »» Fig. 36.
- Keep raising the jack until the wheel comes slightly off the ground.

### ⚠ WARNING

The factory-supplied jack is only designed for changing wheels on this model. On no account attempt to use it for lifting heavier vehicles or other loads. Risk of injury.

- Make sure the jack remains stable. If the surface is slippery or soft, the jack could slip or sink, respectively, with the consequent risk of causing injuries.
- Lift the vehicle using only the jack supplied from the factory. Other jacks, even those approved for other SEAT models could slip, with the consequent risk of injury.
- Place the jack only at the support points provided on the strut and align it. Other-

wise, the jack could slip because it does not have sufficient grip on the vehicle: risk of injury!

- You should never place a body limb such as an arm or leg under a raised vehicle that is solely supported by the jack.
- If you have to work underneath the vehicle, you must use suitable stands additionally to support the vehicle, there is a risk of accident!
- Never raise the vehicle if it is tilting to one side or the engine is running.
- Never start the engine when the vehicle is raised. The vehicle may come loose from the jack due to the engine vibrations.

### ⓘ CAUTION

The vehicle must not be raised on the crossbar. Place the jack only at the support points provided on the strut and align it. Otherwise, the vehicle may be damaged.

## Removing and installing a wheel



**Fig. 37** Wheel change: loosen wheel nuts using the socket in the handle of the screwdriver.

Change the wheel after loosening the wheel bolts and raising the vehicle with the jack.

When removing/fitting the wheel, the rim may hit and damage the brake disc. For this reason, please take care and get a second person to assist you.

### Taking off the wheel

- Using the hexagonal socket in the wheel brace »» Fig. 37, unscrew the slackened wheel bolts and place them on a clean surface.
- Take off the wheel.

### Putting on the spare wheel

Check the direction of rotation of the tyre »» page 42.

»

- Place the spare wheel or temporary spare wheel into position.
- Replace the wheel bolts and tighten *slightly* using the hexagonal socket on the end of the wheel brace.
- To tighten the anti-theft locking wheel bolts use the corresponding adaptor.
- Carefully lower the vehicle using the jack.
- Use the wheel spanner to tighten all of the wheel nuts clockwise. Tighten the bolts in diagonal pairs (not in a circle).
- Put the caps or full hubcap back on.

The wheel bolts should be clean and turn easily. Before fitting the spare wheel, inspect the wheel condition and hub mounting surfaces. These surfaces must be clean before fitting the wheel.

### Tightening torque of the wheel nuts

The prescribed tightening torque for wheel bolts for steel and alloy wheels is **110 Nm**. After changing a wheel, have the tightening torque checked immediately with a torque wrench that is working perfectly.

**Before checking** tightening torque, have any rusty wheel bolts that are difficult to screw replaced and clean the wheel hub threads.

Never apply grease or oil to wheel bolts or to the wheel hub threads. Even if the bolts have

been tightened to the prescribed torque, they could come loose while driving.

### WARNING

**The hexagonal socket in the wheel brace should be used for turning wheel bolts only. Do not use it to loosen or tighten the wheel bolts.**

### Tyres with directional tread pattern

Tyres with directional tread pattern have been designed to operate best when rotating in only one direction. An arrow on the tyre sidewall indicates the direction of rotation on tyres with directional tread. Always observe the indicated direction of rotation in order to guarantee optimum grip and help avoid aquaplaning, excessive noise and wear.

If the tyre is mounted in the opposite direction of rotation, drive with extreme caution, as the tyre is no longer being used correctly. This is of particular importance when the road surface is wet. Change the tyre as soon as possible or remount it with the correct direction of rotation.

### Works after changing a wheel

- *Alloy wheels*: replace the wheel bolt caps.
- *Plate wheels*: replace the wheel hubcap .

- Return all tools to their proper storing location.
- If the replaced wheel does not fit in the spare wheel housing, store it safely in the luggage compartment »» page 89.
- Check the tyre pressure of the newly mounted tyre as soon as possible.
- In vehicles fitted with a tyre pressure indicator, adjust the pressure and store it in memory »» page 192.
- Have the tightening torque of the wheel nuts checked as soon as possible with a torque wrench »» page 42. Meanwhile, drive carefully.
- Have the flat tyre replaced as quickly as possible.

## Changing the windscreen wiper blades

### Wiper service position

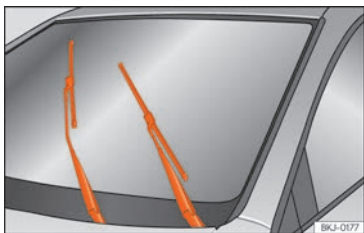

**Fig. 38** Wipers in service position.

The wiper arms can be raised when the wipers are in service position »» **Fig. 38**.

- Close the bonnet »» **page 176**.
- Switch the ignition on and off.
- Press the windscreen wiper lever downwards briefly »» **page 82** (4).

Before driving, always lower the wiper arms. Using the windscreen wiper lever, the windscreen wiper arms return to their initial position.

### Note

- The windscreen wiper arms can be moved to the service position only when the bonnet is properly closed.
- You can also use the service position, for example, if you want to fix a cover over the windscreen in the winter to keep it clear of ice.

### Changing the wiper rear wiper blades

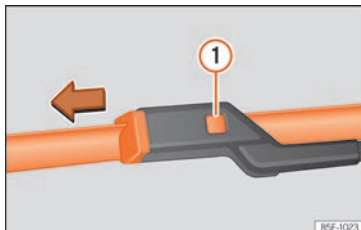

**Fig. 39** Changing the windscreen wiper blades

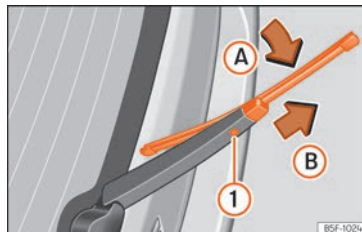

**Fig. 40** Removing and fitting the rear window wiper blade.

The windscreen wiper blades are supplied as standard with a layer of graphite. This layer is responsible for ensuring that the wipe is silent. If the graphite layer is damaged, the noise of the water as it is wiped across the windscreen will be louder.

Check the condition of the wiper blades regularly. **If the wipers scrape across the glass**, they should be changed if they are damaged, or cleaned if they are dirty »» (1).

If this does not produce the desired results, the setting angle of the windscreen wiper arms might be incorrect. They should be checked by a specialised workshop and corrected if necessary.

Damaged windscreen wiper blades should be replaced immediately. These are available from qualified workshops. »»

### Raising and lowering windscreen wiper arms

- Place the windscreen wipers in the service position »» page 43.
- Grip the wiper arms **only** by the blade's fastening point.

### Cleaning windscreen wiper blades

- Raise the wiper arms.
- Use a soft cloth to remove dust and dirt from the windscreen wiper blades.
- If the blades are very dirty, a sponge or damp cloth may be used »» ❶.

### Changing the windscreen wiper blades

- Lift and unfold the wiper arms.
- Press and hold release button »» Fig. 39 ❶ and pull gently on the wiper blade in the direction of the arrow.
- Fit a new wiper blade of the **same length and design** on to the wiper arm and hook it into place.
- Rest the wiper arms back onto the windscreen.

### Changing the rear wiper blade

- Lift and fold the wiper arm.
- Turn the blade slightly »» Fig. 40 (arrow A).

- Hold down the release button ❶ while gently pulling the blade in the direction of arrow B.
- Insert a new blade of the **same length and type** in the rear wiper arm in the opposite direction to the arrow B and hook into place button ❶.
- Replace the wiper arm on the rear window.

### ⚠ WARNING

**Worn or dirty windscreen wiper blades reduce visibility and increase the risk of accident and serious injury.**

- Always replace damaged or worn windscreen wiper blades or blades that no longer clean the windscreen properly.

### ❗ CAUTION

- Damaged or dirty windscreen wipers could scratch the glass.
- If products containing solvents, rough sponges or sharp objects are used to clean the blades, the graphite layer will be damaged.
- Never use fuel, nail varnish remover, paint thinner or similar products to clean the windows.
- In icy conditions, always check that the wiper blades are not frozen to the glass before using the wipers. In cold weather, it may help to leave the vehicle parked with the wipers in service position »» page 43.

### ❗ CAUTION

- To prevent damage to the bonnet and the wiper arms, only leave them in the service position.
- Before driving, always lower the wiper arms.

## Jump start

### Jump leads

The jump lead must have a sufficient wire cross section.

If the engine fails to start because of a discharged battery, the battery can be connected to the battery of another vehicle to start the engine.

Jump leads must comply with standard **DIN 72553** (see cable manufacturer's instructions).

### ❗ Note

- The vehicles must not touch each other, otherwise electricity could flow as soon as the positive terminals are connected.
- The discharged battery must be properly connected to the on-board network.

## Jump start: description

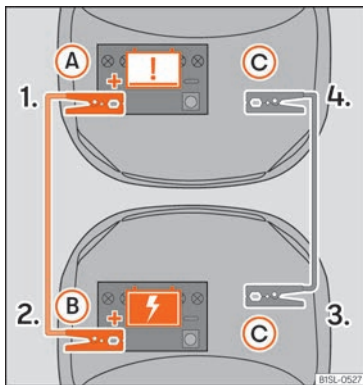

Fig. 41 Connection diagram.

### Jump lead terminal connections

The jump leads should only be connected following the order »» Fig. 41 1. > 2. > 3. > 4.

- Switch off the ignition of both vehicles »» ⚠.
- Connect one end of the *red* jump lead to the positive + terminal of the vehicle with the flat battery (A) »» Fig. 41.
- Connect the other end of the *red* jump lead to the positive terminal + in the vehicle providing assistance (B).

- Connect one end of the *black* jump lead (C), to a suitable earth terminal, to a piece of solid metal that is bolted to the crankcase or to the crankcase of the vehicle itself that supplies the power.
- Connect the other end of the *black* jump lead (C), in to the vehicle with the discharged battery, to a piece of solid metal that is bolted to the crankcase or to the crankcase itself but as far as possible from the battery (A). Do not connect the black jump lead to the negative pole – of the 12-volt battery. If it is connected, this may cause an erroneous evaluation of the state of the battery inside the electronic system of the vehicle.
- Position the leads in such a way that they cannot come into contact with any moving parts in the engine compartment.

Make sure the battery clamps have sufficient metal-to-metal contact with the battery terminals.

### Starting

- Start the engine of the vehicle with the boosting battery and let it run at idling speed.
- Connect the vehicle's drive system with the discharged 12-volt battery.

### Removing the jump leads

- Before you remove the jump leads, switch off the dipped beam headlights if they are switched on.

- When the engine is running, disconnect the leads in reverse order to the details given above.

If the engine fails to start after about 10 seconds, switch off the starter and try again after about 1 minute.

### ⚠ WARNING

- Please note the safety warnings referring to working in the engine compartment »» page 176.
- The battery providing assistance must have the same voltage as the flat battery (12V) and approximately the same capacity (see imprint on battery). Failure to comply could result in an explosion.
- If one of the batteries is frozen, do not attempt to start the engine with the jump leads, as this may cause an explosion. Even after the battery has thawed, battery acid could leak and cause chemical burns. If a battery freezes, it should be replaced.
- Keep sparks, flames and lighted cigarettes away from batteries, danger of explosion. Failure to comply could result in an explosion.
- Observe the instructions provided by the manufacturer of the jump leads.
- Do not connect the negative cable from the other vehicle directly to the negative terminal of the flat battery. The gas emitted from the battery could be ignited by sparks. Danger of explosion.

»

- Never attach the negative cable to fuel system components or the brake lines in the other vehicle.
- The non-insulated parts of the battery clamps must not be allowed to touch. The cable that goes to the positive pole of the battery should never come into contact with electrically conductive parts of the vehicle, as this may cause a short circuit.
- Do not lean on the batteries. This could result in chemical burns.

**Note**

The vehicles must not touch each other, otherwise electricity could flow as soon as the positive terminals are connected.

## Tow start and towing

### Tow start

The vehicle is not suitable for starting other vehicles by towing.

Due to technical reasons it is not possible to start the vehicle by towing. Try connecting the drive system with the jump start »» page 44.

### Front towline anchorage



**Fig. 42** Right side of the front bumper: remove the cover.



**Fig. 43** Right side of the front bumper: towline anchorage in position.

The housing of the screw towing eye is on the right side of the front bumper behind a lid »» Fig. 42.

The towing eye should always be kept in the vehicle.

### Fitting the towline anchorage

- Remove the towing eye from the vehicle tool kit in the luggage compartment »» page 34.
- Remove the cover by pressing down on the top and leave it hanging from the vehicle »» Fig. 42.
- Screw the towing eye in the housing by turning it as far as it will go **anticlockwise** »» Fig. 43 »» ❶. Use a suitable object that can completely and securely tighten the towing eye in its housing.
- After towing, unscrew the towing eye **clockwise** with a suitable object.
- Replace the cover and press on its lower part until the tab snaps into the bumper.
- Clean the towing eye if necessary and then store it in the luggage compartment along with the other vehicle tools.

**❶ CAUTION**

The towing eye must always be completely and firmly tightened. Otherwise, it could be released while towing and tow-starting.



## Fuses and bulbs

### Fuses

#### Introduction

In general, a fuse can be assigned to various electrical components. Likewise, an electrical component can be protected by several fuses.

Only replace fuses when the cause of the problem has been solved. If a newly inserted fuse blows after a short time, you must have the electrical system checked by a specialised workshop as soon as possible.

#### ⚠ WARNING

The high voltages in the electrical system can give serious electrical shocks, causing burns and even death!

- Never touch the electrical wiring of the ignition system.
- Take care not to cause short circuits in the electrical system.

#### ⚠ WARNING

Using unsuitable fuses, repairing fuses or bridging a current circuit without fuses can cause a fire and serious injury.

- Never use a fuse with a higher value. Only replace fuses with a fuse of the same am-

perage (same colour and markings) and size.

- Never replace a fuse by a metal strip, staple or similar.

#### ⚠ CAUTION

To prevent damage to the vehicle's electric system, before replacing a fuse always turn off the ignition, the lights and all electrical elements and remove the key from the ignition.

#### i Note

In the vehicle, there are more fuses than those indicated in this chapter.

#### Fuses inside the vehicle

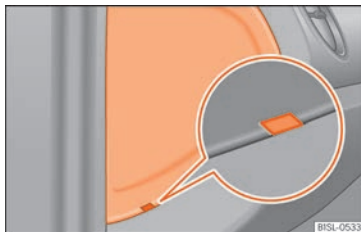

**Fig. 44** On the driver side: the instrument panel fuse box cover.

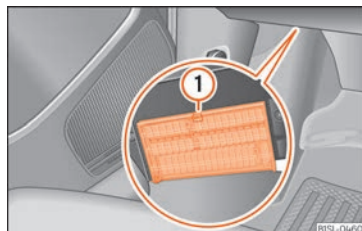

**Fig. 45** On the driver's side underneath the instrument panel: fuse box cover.

#### To open the instrument panel fuse box

- Open the driver's door (front left).
- Fit a flat object, i.e. a screwdriver, in the groove »» Fig. 44 and carefully lever to remove the cover.

#### Opening and closing the fuse box located below the instrument panel

- **Open:** Press the unlock button »» Fig. 45 ① until it is possible to open the cover. Fold the cover down.
- **Close:** Fold the cover up in the opposite direction to the arrow until it clicks into the locking lever ①.



Identifying fuses below the dashboard by colours

Colour	Amp rating
Purple	3
Light brown	5
Brown	7.5
Red	10
Blue	15
Yellow	20
White or transparent	25
Green	30
Orange	40

### ⓘ CAUTION

- Always carefully remove the fuse box covers and refit them correctly to avoid problems with your vehicle.
- Protect the fuse boxes when open to avoid the entry of dust or humidity. Dirt and humidity inside fuse boxes can cause damage to the electrical system.

## Fuses in the engine compartment

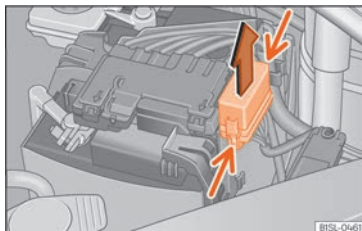
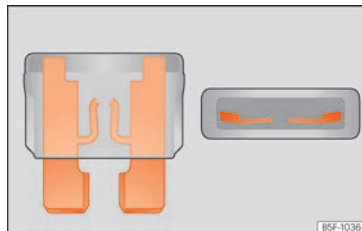

**Fig. 46** In the engine compartment: fuse box cover.

### To open the engine compartment fuse box

- Open the bonnet » page 176.
- Press the locking tabs to release the fuse box cover » **Fig. 46**.
- Then lift the cover out.
- To **fit** the cover, place it on the fuse box. Push the locking tabs down until they click audibly into place.

## Replace a blown fuse



**Fig. 47** Image of a blown fuse.

### Preparations

- Switch off the ignition, lights and all electrical equipment.
- Open the corresponding fuse box » page 47, » page 48.

### Recognise a blown fuse

A fuse is blown if its metal strip is ruptured » **Fig. 47**.

- Point a lamp at the fuse to see if it has blown.

### To replace a fuse

- Remove the fuse.
- Replace the blown fuse by one with an *identical* amperage rating (same colour and markings) and *identical* size.

- Replace the cover again or close the fuse box lid.

## Changing bulbs

### Introduction

Changing bulbs requires a certain degree of practical skill. If you are unsure, SEAT recommends that you consult a technical service or request assistance from a specialist. In general a specialist is needed if, in addition to the bulbs, other vehicle components require removal.

If you choose to change the engine compartment lamps yourself, remember that it is a dangerous area **»** .

Always use identical bulbs with the same designation. The name can be found on the base of the bulb holder.

### Additional bulb specifications

The specifications of some headlamp bulbs and bulbs for the rear lamps fitted at the factory may be different to those of conventional bulbs. Bulb information is displayed on the bulb socket or on the bulb itself.

### Bulbs (12 V)

#### Light source used for each function

Halogen headlights.	Type
Daytime running light/side light	W21/5W
Dipped beam headlights	H4 LL
Main beam headlights	H4 LL
Turn signal	PY21W NA

Rear bulb light	Type
Brake/side lights	P21/5W LL
Side lights	P21/5W LL
Turn signal	PY21W NA LL
Retro fog light	P21W
Reverse lights	R10W

#### WARNING

- Take particular care when working on components in the engine compartment if the engine is warm. Risk of burns.
- The H4, HB4 and H7 bulbs are pressurised. They may explode when being replaced, and there is a danger of injury.
- Only replace the bulbs concerned when they have cooled.

- When changing bulbs, please take care not to injure yourself on sharp edges, in particular on the headlight housing.
- Never replace bulbs alone if you are not familiar with the operations necessary. If you are not sure about procedures then visit a specialised workshop to carry out the necessary work.
- Never touch the bulb glass directly. Fingerprints will be evaporated by the heat of the operating bulb thus "fogging" up the reflector.

#### CAUTION

- If, after replacing a bulb, the rubber cover is not correctly positioned in the headlight housing, water or humidity can enter and damage the electrical system.
- Remove the ignition key before working on the electric system. Otherwise, a short circuit could occur.
- Switch off the lights and the parking light before changing a bulb.
- Take good care to avoid damaging any components.

#### For the sake of the environment

Please ask your specialist retailer how to dispose of used bulbs in the proper manner. **»**

## **i** Note

- Please check at regular intervals that all lighting (especially the exterior lighting) on your vehicle is functioning properly. This is not only in the interest of your own safety, but also that of all other road users.
- Before changing a bulb, make sure you have the correct new bulb.

## Changing the bulbs in the headlights

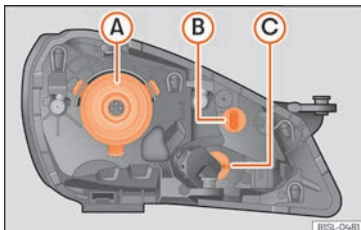

**Fig. 48** In the engine compartment: rear view of the left headlight with rubber cover.

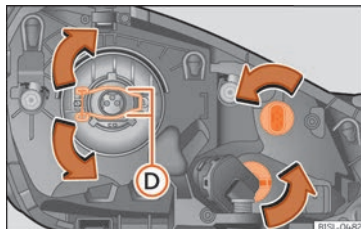

**Fig. 49** Left headlight

- A** Dipped and main beam headlights
- B** Dipped beam lights and daytime running lights
- C** Turn signal

There is no need to remove the headlight to replace bulbs.

### Dipped and main beam headlight **A**

- Open the bonnet **⚠**.
- Remove the H4 lamp connector and the rubber cover from the tabs.
- Press the retaining clip **»» Fig. 49 D** downwards in the direction of the arrow, unclip sideways, and remove it.
- Remove the bulb from the holder. If necessary, press the lock on the bulb holder.
- Replace the faulty bulb with a new identical bulb.

- Insert the bulb, return it to its position and insert the retaining clip **»» Fig. 49 D**.
- Place the rubber cover and check that it is in the correct position. Insert the connector to the bulb H4.

### Dipped beam light and daytime running light **B** / Turn signal **C**

- Open the bonnet **⚠**
- Turn the bulb holder in an **anticlockwise direction** as far as it will go and remove it, along with the bulb, pulling backwards.
- Remove the bulb from the holder. If necessary, press the lock on the bulb holder.
- Replace the faulty bulb with a new identical bulb.
- Insert the bulb holder in the headlight and turn it **clockwise** as far as the stop.

## **i** Note

The images show the left hand headlight from behind. The structure of the right hand side headlight is symmetric.

## Replacing the front bumper bulb

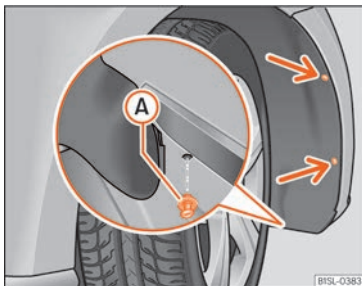

**Fig. 50** Right front wheel arch: access to the bulb

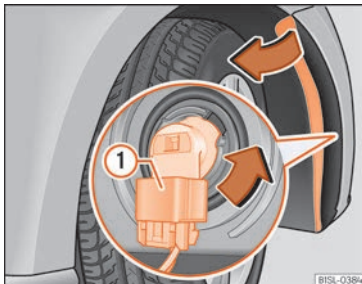

**Fig. 51** Changing the bulbs in the headlights

- Unscrew the 2 retaining screws of the wheel arch trim »» Fig. 50 [arrows] with the screwdriver from the vehicle tool kit »» page 34.
- Unscrew the expansive rivet in the lower front part of the wheel arch trim (A) with the screwdriver from the vehicle tool kit and completely remove it »» page 34.
- Carefully fold the wheel arch trim to the side.
- Release the connector »» Fig. 51 (1) and remove it.
- Turn the bulb holder »» Fig. 51 in the direction of the arrow, **in an anticlockwise direction** as far as it will go and remove it, along with the bulb, pulling backwards.
- Replace the faulty bulb with a new identical bulb.
- Insert the bulb holder in the headlight and turn it **clockwise** as far as the stop.
- Plug the connector (1) into the bulb holder. The connector must audibly click into place.
- Replace the wheel arch trim into its position.
- Place the expansive rivet in the wheel arch trim and bumper and press it completely inwards »» Fig. 50 (A).
- Securely screw the 2 retaining screws »» Fig. 50 (arrows) with a screwdriver.

## Changing the bulbs in the tail lights

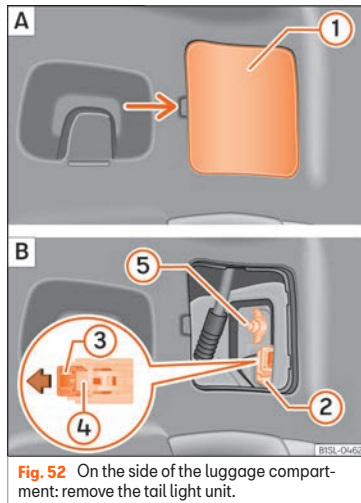

**Fig. 52** On the side of the luggage compartment: remove the tail light unit.

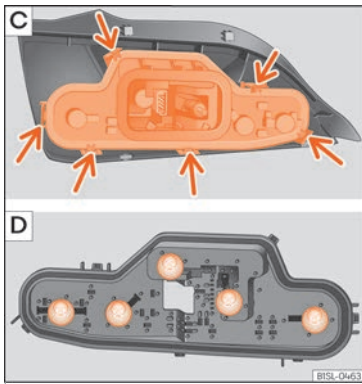

**Fig. 53** Tail light unit: remove the bulb holder

### Removing the rear light units

- Open the rear lid.
- Remove cover ① by carefully levering it »» Fig. 52 [A].
- Pull lock ③ on connector ② in the direction of the arrow »» Fig. 52 [B]. Help yourself with the screwdriver from the vehicle tool kit.
- Press fastener ④ and remove connector ② »» Fig. 52 [B].
- Unscrew wing nut ⑤ »» Fig. 52 [B].
- Remove the tail light from the bodywork by carefully pulling backwards.

- Disassemble the tail light unit and place it on a flat, clean surface.

### To change the bulb

- Unlock the bulb holder on the locking flanges (arrow) »» Fig. 53 [C] and remove the bulb holder from the tail light.
- Replace the damaged bulb with a new identical bulb »» Fig. 53 [D].
- Place the bulb holder in the tail light unit. The locking tabs (arrow) must be heard to engage »» Fig. 53 [C].

### Assembling the rear light units

- Carefully insert the tail light unit into the opening in the bodywork.
- Hold the tail light in the installation position with one hand and tighten the wing nut with the other hand ⑤ »» Fig. 52 [B].
- Ensure that the tail light unit has been correctly fitted and is firmly secured.
- Insert connector ② into the bulb holder and press lock ③ on the connector in the direction opposite to the arrow »» Fig. 52 [B].
- Insert the cover. The cover should lock into place.
- Close the rear lid.

### Changing the number plate bulb

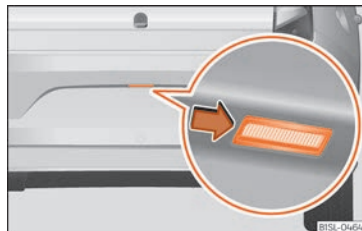

**Fig. 54** In the rear bumper: detach the number plate light.

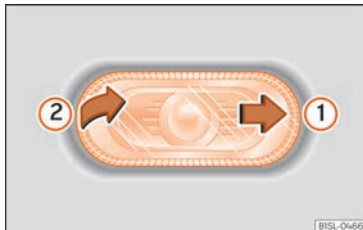

**Fig. 55** Number plate light: remove the bulb holder.

- With one hand, press on the number plate light from left to right and remove it from the bumper »» Fig. 54.
- Detach the number plate light carefully from the bumper.

- Turn the bulb holder with the bulb **anti-clockwise** and remove it in the direction of the arrow »» Fig. 55.
- Replace the faulty bulb with a new identical bulb.
- Place the bulb holder in the number plate light and press in the opposite direction to the arrow as far as possible »» Fig. 55.
- Insert the number plate light carefully into the left edge of the opening on the bumper. During this process, check that the assembly direction of the number plate light is correct, i.e. the spring must be on the right.
- Insert the number plate light into the bumper until it audibly clicks into place.

### Replace the side turn signal bulb



**Fig. 56** Removing the side turn signal

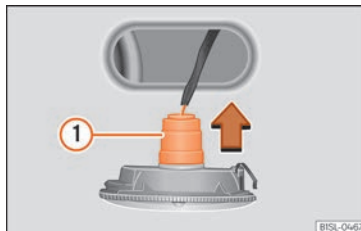
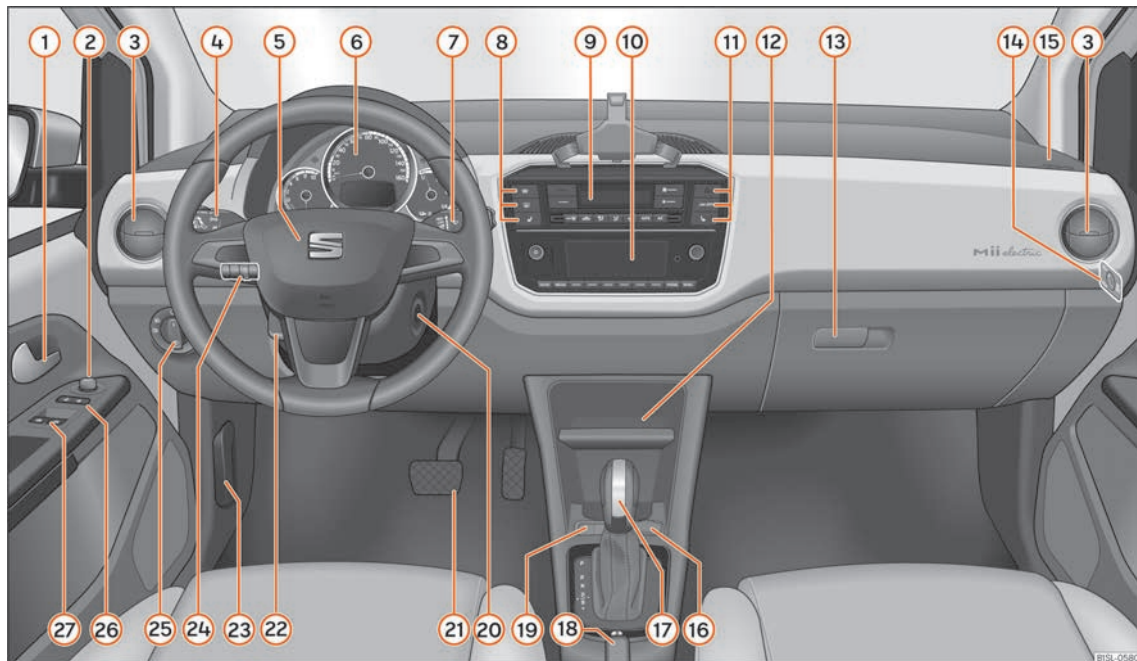

**Fig. 57** Side turn signal: Bulb replacement.

- With one hand move the side turn signal backwards »» Fig. 56 ①.
- Remove the side turn signal from the chassis by leverage ②.
- Remove the bulb holder with the bulb in the direction of the arrow »» Fig. 57 ①.
- Remove the bulb holder bulb in a straight direction.
- Replace the faulty bulb with a new identical bulb.
- Install the bulb holder.
- Place the side turn signal on the chassis on the side situated towards the rear of the vehicle until the spring clicks into the other side of the side turn signal.

### Additional brake light

Taking into account that it consists of LED bulbs, the change should be made at a technical service centre.



**Fig. 58** Instruments and controls.

8TSL-0560



## Operation

### Controls and displays

#### Interior view

##### Overview

① Door handle .....	72	⑩ Radio (factory fitted) .....	107	⑳ Buttons for operating the front electric windows .....	75
② Switch for adjusting the exterior mirrors .....	85	⑪ Buttons for:			
③ Air vents .....	102	– Turn the emergency lights on and off .....	80		
④ Lever for:		– Lane Assist .....	148		
– Turn signals and main beam headlights .....	78	– Right seat heating controls .....	103		
– Cruise control system (CCS) .....	146	⑫ Storage compartment with drink holder in the centre console .....	95		
⑤ Steering wheel with horn and driver airbag .....	22	⑬ Storage glove compartment .....	94		
⑥ Instrument panel .....	56	– Tyre pressure monitoring .....	192		
⑦ Lever for:		⑭ Key switch for switching off the front passenger airbag .....	23		
– Wipers and rear window wiper .....	82	⑮ front passenger front airbag .....	22		
– Multi-function display control .....	63	⑯ 12 volt socket or cigarette lighter* .....	97		
⑧ Buttons for:		⑰ automatic gearbox lever .....	140		
– Windscreen heating .....	101	⑱ Handbrake .....	152		
– Rear window heater .....	101	⑲ Controls for:			
– Left seat heating controls .....	103	– Selecting the driving profile .....	144		
⑨ Controls for the Climatronic .....	100	– Selecting charging mode .....	160		
		⑳ Ignition lock .....	135		
		㉑ Pedals			
		㉒ Steering column adjustment lever .....	13		
		㉓ Open bonnet lever .....	177		
		㉔ Headlight range control .....	80		
		㉕ Light switch .....	76		
		㉖ Central locking button .....	69		

## Instruments and warning/control lamps

### Instrument panel

#### Introduction

#### WARNING

Any distraction may lead to an accident, with the risk of injury.

- Do not operate the instrument panel controls when driving.
- To reduce the risk of accident and injury, only make adjustments to the instructions on the instrument panel display and to the instructions on the Infotainment system display when the vehicle is stationary.

## Analogue instrument panel



**Fig. 59** Front passenger airbag located in instrument panel.

Details of the instruments » **Fig. 59:**

- ① **Speedometer.** Depending on the vehicle in km/h or in mph.
- ② **Power display** » page 57
- ③ **Time set button** » page 59
- ④ **Display indications** » page 59.
- ⑤ **Charge level display:** indicates the level of charge of the high voltage battery » page 163.
- ⑥ **Reset button** for trip recorder [ **trip** ].

**i Note**

Depending on the vehicle, other functions of the multifunction display can be displayed on the screen of a mobile phone.

**Power display and available power**

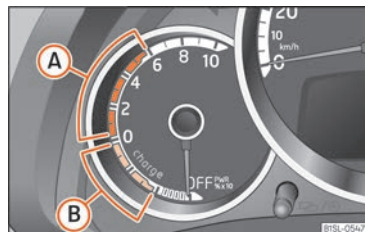

**Fig. 60** On the instrument panel: power display with zones for low consumption operation (A) and for brake energy recuperation (B).

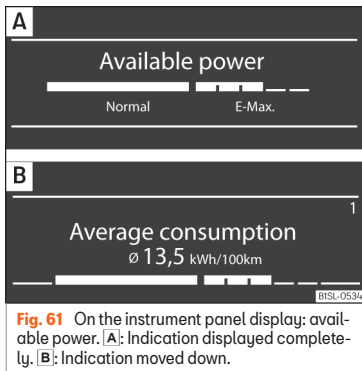

**Fig. 61** On the instrument panel display: available power. **A**: Indication displayed completely. **B**: Indication moved down.

When the drive system is connected and while driving, information on the power used and on the available power is displayed in the instrument panel display.

### Power display

When connecting the drive system before starting to move, the indicator changes from **OFF** to **0** » **Fig. 60**.

When the vehicle is moving, the power used at that moment to move is indicated in the instrument panel display (in % PWR x 10) » **Fig. 60**.

- A** When the indicator needle is in the blue zone, the vehicle is moving with a particularly low energy consumption.
- B** When the indicator needle is in the green zone, the brake energy and kinetic energy are converted into electrical energy (energy recuperation) by the electric drive system and stored in the high-voltage battery.

### Indication of available power

While driving, the current available power of the electric engine is displayed on the instrument panel display » **Fig. 61 A**. When the instrument panel display changes to another indication, the indication of the available power moves downwards » **Fig. 61 B**.

When all segments are displayed, it means that the maximum power of the electric engine is available. Having high power available is necessary for, i.e. accelerating the vehicle quickly to, for example, overtake safely.

If a lot of power is required for a long period of time (it is mainly seen because the power indicator needle is above the low consumption zone » **Fig. 60 A**), the time during which the maximum power is available is reduced. In the indication of the available power, the segments of the **E-Max** zone turn off from right to left.

When all segments of the **E-Max** zone turn off, it means that the maximum power of the

electric engine is no longer available » **A**. If there is still a high demand, the power currently available is reduced, which is indicated by the shortening of the **Normal** zone bar, starting from the right. Based on the length of the bar, it is possible to know how much the drive power has been reduced. If less power is then used, the available power gradually increases once again.

Limited availability of power may be related to driving behaviour, i.e., accelerating the vehicle quickly. In general, the available power is limited under the following conditions:

- The temperature of the high-voltage battery is very low or very high.
- The level of charge of the high-voltage battery is low.

When the charge level of the high-voltage battery approaches the reserve level, in addition to the available power, the maximum speed at which the vehicle can be driven is also reduced. Charge the high voltage battery as soon as possible » **page 160**.

### ⚠ WARNING

**If the vehicle is driven with a very low a charge level of the high-voltage battery, the vehicle may stall in traffic, causing serious damage or accidents and injuries.**

- Always ensure that the charge level of the high-voltage battery is sufficient!

**⚠ WARNING**

When the maximum power reserve is not available or the level of charge of the high voltage battery is low, the driving properties may vary, i.e. the acceleration behaviour of the vehicle.

- Always adapt the speed and driving style to the conditions of visibility, weather, road and traffic, as well as the charge level of the high-voltage battery.

**ⓘ CAUTION**

Leaving the vehicle parked for a long period of time with the high-voltage battery discharged may cause irreversible damage to the battery.

- Always charge the high-voltage battery immediately.

**Status display**

A variety of information can be viewed on the instrument panel display »» Fig. 59 ②, depending on the vehicle equipment:

- Doors, bonnet and rear lid open
- Warning and information messages.
- Current driving profile
- Odometer.
- Indication of available power »» page 57

- Time.
- Outside temperature.
- Selector lever positions »» page 140.
- Multifunction display (MFI) »» page 63
- Service interval display »» page 63.
- Range indication
- Seat belt status display for rear seats »» page 14.
- Remaining charge time when charging the high-voltage battery »» page 169

**Doors, bonnet and rear lid open**

When the vehicle is unlocked and while driving, the instrument panel display shows if any of the doors, the bonnet or rear lid are opened and, in some cases, it is also indicated by an audible warning. The display may vary according to the type of instrument panel fitted.

**Warning and information messages**

The system runs a check on certain components and functions when the ignition is switched on and while the vehicle is moving. The anomalies are displayed on the instrument panel display by means of warning symbols which, depending on the case, may also be accompanied by an acoustic warning. The display may vary according to the type of instrument panel fitted.

**Current driving profile**

You can choose between three different driving profiles. After changing the driving profile, the new selected profile is displayed on the instrument panel display for a few seconds.

**Odometer**

The *odometer* registers the total distance travelled by the car.

The *odometer (trip)* shows the distance travelled since the last odometer reset. The last figure indicates 100 m.

- Briefly press the button **0.0/SET** to change from the trip odometer and the range indication.
- While viewing the trip odometer, press the button **0.0/SET** for longer to reset the trip odometer and, if necessary, other indications of the multifunction display »» page 61. If you press the button for more than 5 seconds, the "old" value of the trip odometer is reset.

**Indication of available power**

While driving, the current available power of the electric engine is displayed on the instrument panel display »» page 57.

**Time**

- Switch the ignition on.
- To adjust the time, if necessary, change to the indication of the same; to do this, press »

the rocker switch on the wiper lever or the adjustment button on the instrument panel.

- Pressed the button and hold pressed to mark the hour field. This will flash.
- To move forward, press the button **0.0/SET**. To move quickly, keep it pressed.
- Briefly press the button to change to the minute field. This will flash.
- To move forward, press the button **0.0/SET**. To move quickly, keep it pressed.
- To finish setting the time, press the button again .

### Outside temperature indicator

When the outside temperature is below +4°C (+39°F), the “ice crystal” (risk of frost warning) symbol is displayed in addition to said temperature. At first this symbol flashes and then it remains lit until the outside temperature rises above +6°C (+43°F) .

When the vehicle is stopped, when the independent air conditioning is connected or when driving at very low speed, the indicated outside temperature may be higher than the real one due to the heat emitted by the electric drive system.

The temperatures measured range from -40°C to +50°C [-40°F to +122°F].

### Selector lever positions

The current position of the selector lever is displayed both next to the lever, using illuminated letters, and on the instrument panel display.

### Range indication

It indicates the approximate distance in km that can still be travelled with the current capacity of the battery charge if the same driving style is maintained. The calculation is made based on current energy consumption, among other factors.

- To change between the indication of the range and the trip odometer, *briefly* press the adjustment button located on the instrument panel.

### Seat belt status display for rear seats\*

The seat belt status display on the instrument panel display informs the driver, when the ignition is switched on, whether any passengers in the rear seats have fastened their seat belts [page 14](#).

#### WARNING

If the warning lamps are ignored, the vehicle may stall in traffic, or may cause accidents and severe injuries.

- Never ignore the warning lamps.

- Stop the vehicle safely as soon as possible.
- A faulty vehicle represents a risk of accident for the driver and for other road users. If necessary, switch on the hazard warning lamps and put out the warning triangle to advise other drivers.
- Park the vehicle away from traffic and ensure that no highly flammable materials are under the vehicle that could come into contact with the exhaust system (e.g. dry grass, fuel).

#### WARNING

Even though outside temperatures are above freezing, some roads and bridges may be icy.

- At outside temperatures above +4°C (+39°F), even when the “ice crystal symbol” is not visible, there may still be patches of ice on the road.
- The outside temperature sensor takes a guideline measurement.

#### CAUTION

Failure to heed the warning lamps when they appear may result in faults in the vehicle.

#### Note

When several warnings are active at the same time, the symbols are shown

successively for a few seconds and will stay on until the fault is rectified.

## Driving data indicator (multifunction display)

The display of the travel data (multifunction display) shows different values about the journey and the consumption.

### Change from one display to another

- Press rocker switch  »» Fig. 62 ② on the windscreen wiper lever.

### Driving data memories

The multifunction display has two automatic memories:

- 1 **Partial memory:** The memory collects journey and consumption data from when the ignition is turned on until when it is turned off. The memory is automatically deleted if the journey is interrupted for more than 2 hours. If the journey is continued in less than 2 hours after the ignition is switched off, the new data is added to the data already stored in the memory.
- 2 **Total memory:** The memory records the values for a specific number of partial trips, up to a total of 19 hours and 59 mi-

nutes, or 1,999.9 km (miles), depending on the model of instrument panel. On reaching either of these limits, the memory is automatically erased and starts to count from 0 again.

The selected memory will be shown in the upper right-hand corner of the display.

### Changing memory

- With the ignition switched on, and displaying memory 1 or 2, briefly press button  »» Fig. 62 ① to change from one memory to another

### Manually erasing memory 1 or 2

- Select the memory that you wish to erase.
- Hold button  pressed for about 2 seconds.

### Possible displays

- **Time:** Current time in hours (h) and minutes (min).
- **Travelling time:** This indicates the hours (h) and minutes (min) since the ignition was switched on.
- **Consumption:** The current energy consumption is indicated. While driving, it is indicated in kilowatt-hours per 100 kilometres (kWh/100 km). When the vehicle is stopped with the drive system on, current energy consumption is indicated in kWh.

- **Average consumption:** Indication of the average power consumption in kilowatt-hour per 100 kilometres (kWh/100 km). The indication appears after travelling approximately 100 meters. Until then, dashes appear. The indicated value is updated every 5 seconds approx.

- **Range:** It indicates the approximate distance in km that can still be travelled with the current capacity of the battery charge if the same driving style and consumption are maintained. The calculation is made based on current energy consumption, among other factors. Keep in mind that autonomy can vary very considerably if, for example, the climate control is switched on or off or if the driving profile is changed. In the calculation of the autonomy, the difference between the temperature of the passenger compartment and the outside temperature when the climate control is connected also influences. The following applies to the forecast autonomy: The more energy the convenience consumers use, such as climate control and seat heating, the less energy will be available for the rest of the journey.

- **Power availability:** While driving, the current available power of the electric engine is displayed on the instrument panel display »» page 57.

- **Distance:** Distance in km travelled since the ignition was switched on.

»

- **Average speed:** After switching on the ignition, the average speed starts to be displayed after travelling approximately 100 meters. Otherwise horizontal lines are displayed. The value shown is updated approximately every 5 seconds.
- **Digital speed display:** Current speed displayed digitally.
- **Digital outside temperature display:** Current outside temperature in digital format.
- **Speed warning at --- km/h:** If the stored speed is exceeded, between 30 km/h (18 mph) and 250 km/h (155 mph), an acoustic warning is sounded and, if necessary, an optical warning also. Depending on the country, this warning also occurs when driving at speeds above 120 km/h (75 mph). This warning is mandatory by law and you are **not** allowed to change it.

### Storing a speed for the speed warning

- Select the display **Speed warning at --- km/h**.
- Press the button **OK/RESET** on the wiper lever to memorise the current speed and deactivate the warning.
- Adjust to the desired speed for 5 seconds using the rocker switch **TRIP** on the wiper lever. Next, press the **OK/RESET** again or wait for a few seconds. The speed is stored and the warning activated.

- To deactivate, press **OK/RESET**. The stored speed is deleted.

## Warning and information messages (Vehicle status)

The system runs a check on certain components and functions when the ignition is switched on and while the vehicle is moving. Faults displayed on the instrument panel as red and yellow warning symbols accompanied with messages and, depending on the case, even an audible warning » **page 65**. The representation of the messages and symbols may vary depending on the version of the instrument panel.

### Priority 1 warning (red)

The symbol lights up or flashes (in part accompanied by audible warnings). **Stop driving!** Danger! Check the fault and eliminate the cause. If necessary, seek professional assistance.

### Priority 2 warning (yellow)

The symbol lights up or flashes (in part accompanied by audible warnings). Operating faults or the lack of operating fluids can cause damage to the vehicle or a fault. Check the faulty function as soon as possible. If necessary, seek professional assistance.

## Information message

It provides information about processes in the vehicle.

## Settings Menu

The actual number of menus available and the names of their options depend on the electronic system and the vehicle's equipment.

### Multifunction display

Information and configuration options of the multifunction indicator » **page 61**.

### Vehicle status

Current warning and information messages. This menu option only appears when there are messages of this type. The number of existing messages is indicated on the display.

### Language

Setting the language of the texts on the display.

### Multifunction display data

Setting the data that must be displayed on the multifunction display of the instrument panel display.



## Time

Hours and minutes of the instrument panel clock. The time can be displayed in 12 or 24 hour format. If necessary, an S appears at the top of the display to indicate that the summer time is set.

## Units

Adjusting the temperature, consumption and distance units.

## Service

Checking service messages.

## Factory settings

The default factory setting of some functions are reset in the **Settings** menu.

## Service intervals

The inspection message appears on the instrument panel display »» Fig. 59 ②.

The dates of the services (i.e. the next Inspection Service or change of brake fluid) are detailed on the sticker on the door pillar or in the Maintenance Schedule.

The set service intervals have been specified with **the service dependent on time/distance travelled**.

## Inspection reminder

If an inspection expires soon, an **Inspection reminder** appears in the form of an abbreviation **InSP** and an indication in **km** appears when the ignition is switched on. The number of kilometres shown is the maximum number that may be driven until the next service.

## Service due

After the **service date**, an audible warning is given when the ignition is switched on and the abbreviation **InSP** will flash on the display for a few seconds.

## Check the service date

With the ignition switched on, the engine off and the vehicle stopped, the current service can be checked:

- Select the menu **Settings**.
- Select the **Information** option from the **Service** submenu. If the service has not been carried out when due, **Service from --- km or --- days** will appear on the instrument panel display.

## Restart the service interval display

If the service has not been performed by a SEAT dealer, the indicator can be reset in the instrument panel as described below:

- Switch the ignition off.

- Press the button **0.0/SET** on the instrument panel and keep it pressed.
- Switch ignition back on.
- Release the button **0.0/SET** and press it again briefly before about 10 seconds have elapsed.

**Do not** restart the indicator between the service intervals, otherwise the information displayed will be incorrect.

### Note

- **The service message disappears after a few seconds, when the engine is started or when the **OK/RESET** button is pressed on the wiper lever.**
- **If the 12-volt battery was disconnected for a long period of time, it will not be possible to calculate the days remaining until the next service. Hence, the indicator may show incorrect calculations. In this case it will be necessary to take into account the maximum maintenance intervals allowed** »» page 194.

## Using the instrument panel

### Introduction

With the ignition switched on it is possible to access different messages via the display on the instrument panel display. »

Some menu options can only be read when the vehicle is stationary.

The number of messages displayed on the instrument panel display will vary according to the vehicle electronics and equipment.

A specialised workshop will be able to programme or modify additional functions, according to the vehicle equipment. SEAT recommends taking your car in for technical service.

## Instrument panel menus

- Multifunction display »»» page 61
- Audio.
- Telephone.
- Vehicle status »»» page 62.
- Setup »»» page 62

## Main menu

- **MFA:** Information and setting options of the multifunction indicator »»» page 61
- **Vehicle status:** Current warning and information messages. This menu option only appears when there are messages of this type. The number of existing messages is indicated on the display. Example: **1/1** or **2/2** »»» page 59.
- **Settings:** Different setting options, i.e. for the time, language and units »»» page 62.

## ⚠ WARNING

**Distracting the driver in any way can lead to an accident and cause injuries.**

- **Never use the menus on the instrument panel display while the vehicle is in motion.**

## i Note

**After loading or changing the 12-volt battery, check the system settings. If the power supply is interrupted, the system settings might be incorrect or deleted.**

## Operation with the wiper lever

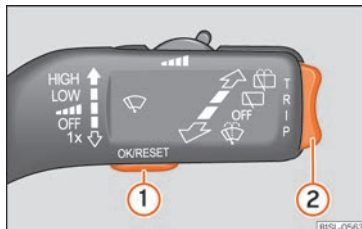

**Fig. 62** Wiper lever: buttons for using the instrument panel menus.

As long as a priority 1 »»» page 62 warning is active, it will not be possible to access any menu. Some warnings can be confirmed and hidden with the button »»» Fig. 62 ①.

## Select a menu or an informative display

- Switch the ignition on.
- If a message or a vehicle pictogram is displayed, press the button **OK/RESET** ①; several times if necessary.
- To display the menus or to return to the menu selection from a menu or from an information displays, press and hold the rocker switch **TRIP** ②.
- To change from one menu to another, press the upper or lower part of the rocker switch.
- To open the menu or the information display that is displayed, press the button **OK/RESET** ① or wait a few seconds until the menu or information display opens automatically.

## Changing menu settings

- In the menu displayed, press the upper or lower part of the rocker switch ② until the required menu option is checked. The option appears framed.
- Press the button **OK/RESET** ① to make the desired modifications. A mark indicates that the system or function is activated.

## Back to menu selection

Select **Back** on the corresponding menu to exit.

## Note

If when switching on the ignition warnings are shown about existing faults, it might not be possible to change the settings or show the information as described. In this case, go to a specialised workshop and request a repair.









## Control lamps







### Control and warning lamps

The control and warning lamps are indicators of warnings , faults or certain functions. Some control and warning lamps come on when the ignition is switched on, and switch off when the engine starts running, or while driving.

















When certain control and warning lamps are lit, an audible warning is also heard.







#### Red warning lamps

	Handbrake  page 150.
	Fault in the brake system  page 150.
	Coolant of the drive system  page 178.
	Fault in the steering system  page 144.









	Driver or passenger has not fastened seat belt  page 14.
	Fault in the generator  page 185.
	Failure in the electric drive system  page 140.

#### Yellow warning lamps



	Fault in ESC or disconnection caused by the system; <b>OR</b> ESC or ASR in operation  page 152.
	Fault in Traction Control* or disconnection caused by the system; <b>OR</b> Traction Control* in operation  page 152.
	Fault in the ABS  page 152.
	Rear fog light switched on  page 76.
<b>EPC</b>	Fault in the engine management  page 135.
	The operation of the electromechanical steering is limited  page 144.
	High-voltage battery charging; <b>OR</b> level of charge of the high-voltage battery is low.
	Fault in airbag system and seat belt tensioners  page 22.
	Failure in the electric drive system  page 140.

	Almost empty high-voltage battery  page 160.
	Tyre pressure monitor system  page 192.
	Lane Assist warning system in operation  page 148.







#### Green indicator lamps

	Turn lights or emergency lights on  page 76.
	Cruise control  page 146.
	Press the foot brake  page 140.
<b>READY</b>	Indication that the drive system is connected  page 136.
	Lane assist warning (Lane Assist)  page 148.

#### Blue indicator lamps

	Main beam on or flasher on  page 76.
--	---

#### Other warning lamps

	Door(s), rear lid or bonnet open or not properly closed  page 59.
	Charging connector plugged in  page 164.
	A passenger in the rear seats has fastened their seat belt  page 14.

»



A passenger in the rear seats has not fastened their seat belt »» page 14.



The outside temperature is below +4°C [+39°F] »» page 60.



Service interval display »» page 63.

### WARNING

If the warning lamps and messages are ignored, faults may occur in the vehicle, it may stall in traffic, or accidents and serious injuries may occur.

- Never ignore warning lamps or text messages.
- Stop the vehicle safely as soon as possible.
- A faulty vehicle represents a risk of accident for the driver and for other road users. If necessary, switch on the hazard warning lamps and put out the warning triangle to advise other drivers.
- In any vehicle, the engine compartment is a hazardous area and could cause severe injuries »» page 176.

## Opening and closing

### Set of vehicle keys

#### Vehicle key



**Fig. 63** Assignment of buttons on the remote control key.

- ① Unlock the vehicle
- ② Lock the vehicle
- ③ Unlock only the rear lid. Press the button until all the turn signals on the vehicle flash briefly. You have 2 minutes to open the rear lid. Once this time has passed, it will lock again. In addition, the lamp on the key flashes.
- ④ Folding the key shaft in and out

With the vehicle key the vehicle may be locked or unlocked remotely » page 69.

The vehicle key includes an emitter and battery. The receiver is in the interior of the vehicle. The range of the vehicle key with remote control and new battery is several metres around the vehicle.

If it is not possible to open or close the vehicle using the remote control key, this should be re-synchronised » page 69 or the battery changed » page 68.

Different keys belonging to the vehicle may be used.

#### Control lamp on the vehicle key

When a button on the vehicle key is pressed, the control lamp flashes » Fig. 63 (arrow) once briefly, but if the button is held down for a longer period the control lamp flashes several times, such as in convenience opening.

If the vehicle key control lamp does not light up when the button is pressed, replace the key's battery » page 68.

#### Spare key

To obtain a spare key and other vehicle keys, the vehicle chassis number is required.

Each new key contains a microchip which must be coded with the data from the vehicle electronic immobiliser. A vehicle key will not work if it does not contain a microchip or the microchip has not been encoded. This is also

true for keys which are specially cut for the vehicle.

The vehicle keys or new spare keys can be obtained from a SEAT Official Service, a specialised workshop or an approved key service qualified to create this kind of key.

New keys or spare keys must be synchronised before use » page 69.

#### ⚠ WARNING

- **Never leave children or disabled persons in the vehicle. In case of emergency, they may not be able to leave the vehicle or manage on their own.**
- **An uncontrolled use of the key could start the engine or activate any electric equipment (e.g. electric windows), causing risk of accident. The doors can be locked using the remote control key. This could become an obstacle for assistance in an emergency situation.**
- **Never forget the keys inside the vehicle. An unauthorised use of your vehicle could result in injury, damage or theft. Therefore always take the key with you when you leave the vehicle.**
- **Never remove the key from the ignition if the vehicle is in motion. Otherwise, the steering could suddenly block and it would be impossible to steer the vehicle.**

»

**ⓘ CAUTION**

All of the vehicle keys contain electronic components. Protect them from damage, impacts and humidity.

**ⓘ Note**

- Only use the key button when you require the corresponding function. Pushing the button unnecessarily could accidentally unlock the vehicle or trigger the alarm. It is also possible even when you are outside the radius of action.
- Key operation can be greatly influenced by overlapping radio signals close to the vehicle working in the same range of frequencies, for example, radio transmitters or mobile telephones.
- Obstacles between the remote control and the vehicle, bad weather conditions and discharged batteries can considerably reduce the range of the remote control.
- If the buttons of the vehicle key are pressed or one of the central locking buttons » page 71 is pressed repeatedly in short succession, the central locking briefly disconnects as protection against overloading. The vehicle is then unlocked. Lock it if necessary.
- Spare remote control keys are available at your Technical Service, where they must be matched to the locking system.
- Up to five remote control keys can be used.

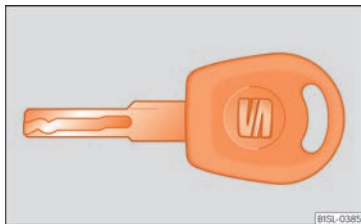
**Vehicle mechanical key**

**Fig. 64** Vehicle mechanical key

The vehicle key set may include a mechanical key » **Fig. 64**.

**Duplicate keys**

To obtain a spare key and other vehicle keys, the vehicle chassis number is required.

Each new key must contain a microchip and be coded with the data from the vehicle electronic immobiliser. A vehicle key will not work if it does not contain a microchip or the microchip has not been encoded. This is also true for keys cut for the vehicle.

The vehicle keys or new spare keys can be obtained from a SEAT dealership, a specialised workshop or an approved locksmith qualified to create them.

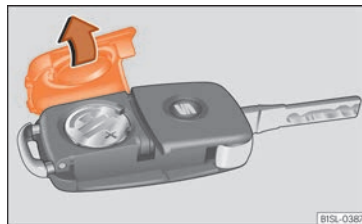
**To change the battery**

**Fig. 65** Vehicle key: opening the battery compartment cover.

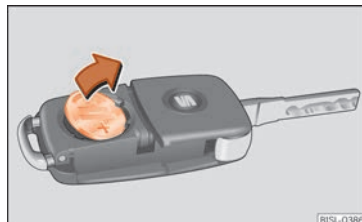

**Fig. 66** Vehicle key: removing the battery.

SEAT recommends you ask a specialised workshop to replace the battery.

The battery is located to the rear of the vehicle key, under a cover.

## Changing the battery

- Unfold the vehicle key blade »» page 67.
- Remove the cover from the back of the vehicle key »» Fig. 65 in the direction of the arrow »» ❶.
- Extract the battery from the compartment using a suitable thin object »» Fig. 66.
- Place the new battery in the compartment as shown »» Fig. 66, pressing in the opposite direction to that shown by the arrow »» ❷.
- Fit the cover as shown »» Fig. 65, pressing it onto the vehicle key casing in the opposite direction to that shown by the arrow until it clicks into place.

### ⚠ WARNING

Swallowing a battery with a 20 mm diameter or any other button battery can cause serious and even fatal injuries within a very short time.

- Keep the vehicle key and key fobs with batteries out of reach of children.
- If you suspect that someone may have swallowed a battery, seek immediate medical attention.

### ❗ CAUTION

- If the battery is not changed correctly, the vehicle key may be damaged.
- Use of unsuitable batteries may damage the vehicle key. For this reason, always re-

place the dead battery with another of the same voltage, size and specifications.

- When fitting the battery, check that the polarity is correct.

### 🌿 For the sake of the environment

The batteries used by the remote control of the ignition key of your vehicle may contain perchlorate. This may involve special handling instructions. Take into account the legal provisions regarding the handling and disposal of these batteries. We recommend ordering this service from a SEAT dealer or a specialised company.

## Synchronize the vehicle key

If the  button is pressed frequently outside of the vehicle range, it is possible that the vehicle can no longer be locked or unlocked using the key. In this case, the key must be re-synchronised as described below:

- Unfold the vehicle key blade »» page 67.
- Press the  button on the vehicle key. For this, it must remain with the vehicle.
- Open the vehicle within one minute using the key shaft.
- Turn on the ignition using the vehicle key. The key has been synchronised.

## Central locking

### Introduction

Central locking functions correctly when all the doors and the rear lid are correctly shut. If the driver door is open, the vehicle *cannot* be locked with the key.

The battery of an unlocked vehicle parked for a long period (e.g. in a private garage) may run down and fail to start the motor.

### ⚠ WARNING

The incorrect use of the central locking system may cause serious injuries.

- The central locking system will lock all doors. A vehicle locked from the inside can prevent any non-authorized individual from opening the doors and accessing the vehicle. Nevertheless, in case of emergency or accident, locked doors will complicate access to the vehicle interior to help the passengers.
- Never leave children or disabled people alone in the vehicle. The central locking button can be used to lock all the doors from within. Therefore, passengers will be locked inside the vehicle. Individuals locked in the vehicle can be exposed to very high or very low temperatures.
- Depending on the time of the year, temperatures inside a locked and closed vehicle can be extremely high or extremely low »»

resulting in serious injuries and illness or even death, particularly for young children.

- Never leave individuals locked in a closed and locked vehicle. In case of emergency, they may not be able to exit the vehicle by themselves or get help.

## Description

Central locking allows all doors, the rear lid and the tank flap to be centrally locked and unlocked:

- From outside, using the vehicle key »» page 70.
- From inside, by pushing the central locking button »» page 71.

The central locking system can be activated or deactivated at a specialised workshop.

In case of a vehicle key fault or central locking system fault, all doors can be locked or unlocked manually.

## Self-locking system to prevent involuntary unlocking

It is an anti-theft system and prevents the unintentional unlocking of the vehicle. If the vehicle is unlocked and none of the doors (including the boot) are opened within 30 seconds, it re-locks automatically.

## Turn signals

The turn signals will flash twice when the vehicle is unlocked and once when the vehicle is locked.

If it does not flash, this indicates that one of the doors, the rear lid or the bonnet is not closed correctly.

## Accidental lock-out

The central locking system prevents you from being locked out of the vehicle in the following situations:

- If the driver door is open, the vehicle cannot be locked with the central locking switch »» page 71.

Lock the vehicle with the remote control key, when all the doors and the rear lid have been closed. This prevents the accidental locking of the vehicle.

### Note

- Never leave any valuable items in the vehicle unattended. Even a locked vehicle is not a safe.
- If the LED on the driver door sill lights up for about 30 seconds when the vehicle is locked, the central locking system is not working properly. You should have the fault repaired at a SEAT Official Service or specialised workshop.

## Unlock and lock from the outside



Fig. 67 Remote control key: buttons.

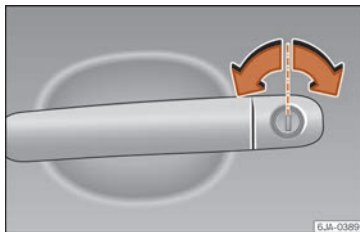







Fig. 68 Driver-side door handle with lock cylinder.

## Unlock and lock using the remote control

- Lock: press the  button »» Fig. 67.
- Locking the vehicle without the "Safe" security system: push the  button again and hold for 2 seconds.
- Unlock: press the  »» Fig. 67 button.



- Unlocking the rear lid: hold down the  button for at least 1 second.

**Attention:** depending on the central locking function set by a specialised workshop, to unlock all the doors and the rear lid it will be necessary to press the  button twice.

### Unlock and lock in the driver's door lock cylinder

- Lock the doors and rear lid: insert the key into the lock cylinder and turn it **clockwise**.
- Unlock the doors and rear lid: insert the key into the lock cylinder and turn it **anticlockwise**.

The vehicle will be locked again automatically if you do not open one of the doors or the rear lid within 30 seconds after unlocking the car. This function prevents the vehicle from remaining unlocked if the unlocking button is pressed by mistake. This does not apply if you press the  button for at least one second.

#### **WARNING**

Observe the safety warnings  in Locking system "Safe"\* on page 72.





#### **Note**

Do not use the remote control key until the vehicle is visible.

### Unlocking and locking from the inside



**Fig. 69** On the driver's door: central locking buttons.

- Lock: press the  button  **Fig. 69**.
- Unlock: press the   **Fig. 69** button.

Please note the following when using the central locking switch to lock your vehicle:

- The "Safe" security system will not activate
- It is not possible to open the doors or the rear lid from the *outside* (for safety reasons, e.g. when stopped at traffic lights).
- You can open the doors individually from the inside by pulling the inside door handle. If necessary, pull the door release lever twice.
- In the event of an accident in which the airbags inflate, doors locked from the inside will be automatically unlocked to facilitate access and assistance.

#### **WARNING**



- The central locking switch also works with the ignition switched off, except when the "safe" system is activated.
- The central locking switch does not operate if the vehicle is locked from the outside and the security system is switched on.
- Locked doors could delay assistance in an emergency. Do not leave anyone, especially children, in the vehicle.

### Locking system "Safe"\*

When the vehicle is locked, the "Safe" security system puts the door handles out of operation and makes it difficult for unauthorized people to enter. The doors cannot be opened from inside .

Depending on the vehicle, when switching the ignition off, a warning may be displayed on the instrument panel display stating that the "Safe" security system is activated.

#### Lock the vehicle and activate the "Safe" security system.

- Press the locking button  once on the vehicle key. 

Lock the vehicle without activating the “Safe” system.

- Press the locking  button on the vehicle key twice.

When the “Safe” security system is disabled, the following needs to be taken into account:

- The vehicle can be opened and unlocked from the inside using an inside door handle.

### “Safe” status

On the driver door, there is warning lamp visible from outside the vehicle through the window which shows the “Safe” system status.

We will know that “Safe” system is activated by the flashing warning lamp.

- “Safe” activated: the warning lamp flashes for about 2 seconds at short intervals; then, more slowly.
- “Safe” deactivated: the warning lamp flashes for about 2 seconds and stops. After 30 seconds, the LED flashes again.
- Locking system fault: the lamp flashes for about 2 seconds at short intervals. Subsequently, the light will remain switched on for about 30 seconds.

### WARNING

Do not leave anyone (especially children) in the vehicle if it is locked from the outside

and the “Safe” security system\* is activated, as the doors and windows cannot then be opened from the inside. Locked doors could delay assistance in an emergency.

## Doors

### Introduction

The doors and rear lid can be locked manually and partially opened, for example if the key or the central locking is damaged.

### WARNING

If a door is not correctly closed, it could open unexpectedly when driving and cause serious injuries.

- Always stop immediately and close the door.
- When closing, ensure that the door has closed correctly. A closed door should be flush with the corresponding parts of the bodywork.
- Open and close doors only when nobody is in the way of the door.

### WARNING

A door held open by its retainer could be blown closed by the wind or close if the vehicle is on a hill, causing injury.

- When opening and closing doors, always use the door handle.

### Locking the passenger door manually

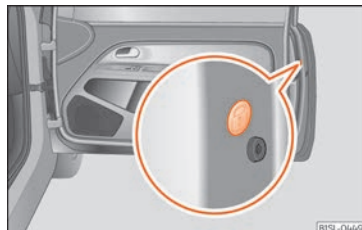

**Fig.70** On the front of the passenger door: emergency lock, hidden by a rubber seal.



**Fig.71** Emergency locking of the vehicle using the vehicle key

The passenger door can be manually locked.

- Open the door.
- Remove the rubber cap to the front of the door. The rubber cap is marked with a lock symbol  »» Fig. 70.
- Unfold the key shaft if necessary »» page 67.
- Insert the key shaft horizontally into the opening and moved the coloured lever forward »» Fig. 71.
- Replace the rubber cap and close the door.
- Check if the door is locked.
- Have the vehicle checked by a specialised workshop.

#### Note

**The doors can be opened and unlocked individually from the inside by pulling the door handle. To open, pull the inner door release lever twice »» page 69.**

## Childproof locks



**Fig. 72** Childproof lock on the left hand side door.

The childproof lock prevents the rear doors from being opened from the inside. This system prevents minors from opening a door accidentally while the vehicle is running.

This function is independent of the vehicle electronic opening and locking systems. It only affects rear doors. It can only be activated and deactivated manually, as described below:

### Activating the childproof lock

- Unlock the vehicle and open the door in which you wish to activate the childproof lock.
- With the door open, rotate the groove in the door using the ignition key, clockwise for the left hand side doors »» Fig. 72 and anti-clockwise for the right hand side doors.

### Deactivating the childproof lock

- Unlock the vehicle and open the door whose childproof lock you want to deactivate.
- With the door open, rotate the groove in the door using the ignition key, anti-clockwise for the left hand side doors »» Fig. 72 and clockwise for the right hand side doors.

Once the childproof lock is activated, the door can only be opened from the outside.

## Rear lid

### Introduction

#### WARNING

**Careless and unsuitable locking, opening and closing of the rear lid can cause accidents and serious injury.**

- **The rear lid must not be opened when the reverse or rear fog lights are lit. This may damage the tail lights.**
- **Do not close the rear lid by pushing it down with your hand on the rear window. The glass could smash. Risk of injury!**
- **Ensure the rear lid is locked after closing it. If not, it may open unexpectedly while driving.**

»

- Closing the rear lid without observing and ensuring it is clear could cause serious injury to you and to third parties. Make sure that no one is in the path of the rear lid.
- Never drive with the rear lid open or half-closed, exhaust gases may penetrate into the interior of the vehicle. Danger of poisoning!
- Never leave the vehicle unattended or allow children to play inside or next to it, especially if the rear lid is open. Children could enter the luggage compartment, close the rear lid and become trapped. A locked vehicle can reach extremely high and low temperatures, depending on the time of year, thus causing serious injuries, illness or even death.

#### ⓘ CAUTION

Before opening or closing the rear lid, make sure that there is enough space to open or close it, e.g. when pulling a trailer or in a garage.

#### ⓘ Note

- Before closing the rear lid, make sure that the key has not been left inside the luggage compartment.
- At outside temperatures of less than 0°C (+32°F), the pressurised gas struts cannot always automatically lift the rear lid. In this case, open the rear lid manually.

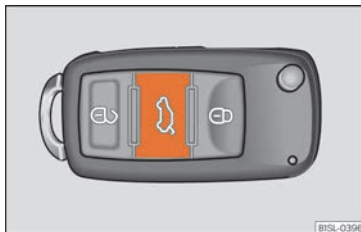

## Opening the rear lid



**Fig. 73** On the vehicle key: button to unlock and open the rear lid.

If bicycles are attached to a rack on the boot hatch, for example, in some cases, it may not open automatically » ⚠ in Introduction on page 73.

### Opening with central locking

- Press the  button on the vehicle key » **Fig. 73** for about one second to unlock the rear lid.
- **OR:** Press the  button on the vehicle key until the rear lid opens automatically several centimetres.
- Open the rear lid using the handle.

### Opening with the key without remote control

- Insert the vehicle key into the lock cylinder of the driver door and turn the key **in an anti-clockwise direction** » page 69.
- Open the rear lid using the handle.

## Closing the rear lid

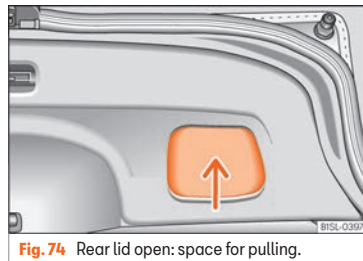

**Fig. 74** Rear lid open: space for pulling.

### Closing the rear lid

- Grab the handgrip inside the rear lid » **Fig. 74** (arrow).
- Push the rear lid downwards until it locks into place in the lock.
- Ensure that it is correctly closed by pulling on it firmly.

**Locking the rear lid with central locking\***

If you unlock the vehicle without opening any doors or the rear lid, it will lock again automatically after about 30 seconds. This function prevents the vehicle from remaining unlocked if the unlocking button is pressed by mistake.

Locking is only possible when the rear lid is correctly and fully closed.

- The rear lid is also locked by a central locking.
- If the vehicle rear lid is locked or unlocked using the  button of the vehicle key, when it is closed again it will lock automatically.
- A closed but not locked rear lid will lock automatically at a speed above about 9 km/h (6 mph).

**Locking the rear lid with the vehicle mechanical key**

Locking is only possible when the rear lid is correctly and fully closed.

- Insert the vehicle key into the lock cylinder of the driver door and turn the key **in a clockwise direction** » page 69.

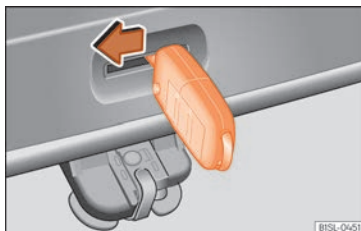

**Emergency unlocking of the rear lid**

**Fig. 75** From the luggage compartment: emergency unlocking of the rear lid.

- If necessary, fold the rear seat bench backrest forward » page 88.
- Remove equipment to access the inside of the rear lid.
- Unfold the key shaft » page 67.
- Insert the key shaft into the rear lid opening » Fig. 75 and press the release lever in the direction of the arrow to unlock the rear lid.

**Window controls****Electrically opening and closing the windows**

**Fig. 76** Detail of the driver's door: window controls.

- Opening the window: press the button .
- Closing the window: pull the button .

**Buttons on the driver door**

- ① Window on the front left door
- ② Window on the front right door

Always close the windows fully if you park the vehicle or leave it unattended » .

** WARNING**

**Incorrect use of the electric windows can result in injury.**

»

- Never close the rear lid without observing and ensuring it is clear, to do otherwise could cause serious injury to you and third parties. Make sure that no one is in the path of a window.
- If the ignition is switched on, the electric equipment could be activated with risk of injury, for example, in the electric windows.
- The doors can be locked using the remote control key. This could become an obstacle for assistance in an emergency situation.
- Therefore always take the key with you when you leave the vehicle.
- The electric windows will work until the ignition has been switched off and one of the front doors has been opened.
- If necessary, use the safety switch to disable the rear electric windows. Make sure that they have been disabled.
- For safety reasons, you should only use the remote control open and close functions within about 2 metres of the vehicle. To avoid injuries, always keep an eye on the windows when pressing the button to close them. The windows stop moving as soon as the button is released.

## Side opening rear windows

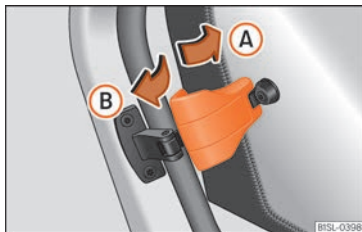

**Fig. 77** Lever to open and close the rear window

### Opening

- Pull the unlocking lever in the direction of arrow **(A)** and press it out, until the lever engages.

### Closing

- Pull the unlocking lever in the direction of arrow **(B)** and press the lever in until it engages.

## Lights

### Vehicle lighting

#### Control lamps

 It lights up

Rear fog light switched on »» page 78.

 It lights up

Left or right turn signal.  
The control lamp flashes twice as fast when a turn signal is faulty.

Hazard warning lights on »» page 80.

 It lights up

Main beam on or flasher on »» page 78.

Several warning and control lamps light up for a few seconds when the ignition is switched on, signalling that the function is being verified. They will switch off after a few seconds.

#### WARNING

Observe the safety warnings »»  in Control and warning lamps on page 66.

## Headlight switch



Fig. 78 Dash panel: lights control.

- Turn the switch to the required position »» Fig. 78.

Symbol	Ignition switch-off	Ignition is switched on
0	Fog lights, dipped beam and side lights off.	Light off or daytime driving light on.
AUTO	The "Coming home" and "Leaving home" guide lights may be switched on.	Automatic control of dipped beam and daytime running light.
↔	Side light on.	
☾	Dipped beam headlight off	Dipped beam switched on.

The driver is personally responsible for the correct use and adjustment of the lights in all situations.

### Automatic dipped beam headlight control AUTO\*

The automatic dipped beam control is merely intended as an aid and is not able to recognise all driving situations.

When the light switch is in position **AUTO**, the vehicle lights and the instrument panel and switch lighting switch on automatically in the following situations »» ⚠:

- The photo sensor detects *darkness*, for example, when driving through a tunnel. They switch off when adequate lighting is detected.
- The rain sensor detects rain and activates the wipers. They switch off when the wipers have not been activated for a few minutes.

### Daytime running lights

The daytime driving light consists of individual lights in the front headlamps.

The DRL LED headlight running lights consist of LED lights. If an LED light fails, go to an authorised workshop for its replacement.

When the daytime driving light is switched on, only the individual lights come on »» ⚠.

The daytime running lights turn on every time the ignition is switched on, if the switch is in position **0** or **AUTO**, according to the level of exterior lighting.

When the light switch is in position **AUTO**, a light sensor automatically switches dipped beam on and off (including the control and instrument lighting) or the daytime running lights depending on the level of exterior lighting.

### Audible warnings to advise the driver that the lights have not been switched off

If the key is not in the ignition and the driver door is open, an audible warning signal is heard in the following cases: this will remind you to turn the light off.

- When the parking light is on »» page 78.
- When the light switch is in position ↔ or ☾.

#### ⚠ WARNING

If the road is not well lit and other road users cannot see the vehicle well enough or at all, accidents may occur.

- The automatic dipped beam control (AUTO) only switches on the dipped beam when there are changes in light conditions but not, for example, when it is foggy.

#### ⚠ WARNING

The side lights or daytime running lights are not bright enough to illuminate the road »»

ahead and to ensure that other road users are able to see you.

- Always use your dipped beam headlights if it is raining or if visibility is poor.
- Never drive with daytime lights if the road is not well lit due to weather or lighting conditions.
- On vehicles with rear lights with bulbs, when activating the daytime running light the rear lights are not switched on. A vehicle which does not have the rear lights on may not be visible to other drivers in the darkness, in the case of heavy rain or in conditions of poor visibility.

### ⚠ WARNING

If the headlights are set too high and not used correctly, there is a risk of dazzling or distracting other road users. This could result in a serious accident.

- Always make sure that the headlights are correctly adjusted.

### **i** Note

- The legal requirements regarding the use of vehicle lights in each country must be observed.
- The dipped beam headlights will only work with the ignition on. The side lights come on automatically when the ignition is turned off.

## Fog lights



Fig. 79 Dash panel: lights control.

The warning lamps ⚡ or ⚡ also show, on the light switch or instrument panel, when the front fog lights are on.

- **Turning on the front fog lights\* ⚡:** pull the light switch out to its first click position >>> Fig. 79 ①, from positions ⚡, ⚡ or AUTO.
- **Turning on the rear fog light ⚡:** pull the light switch fully out ② from position ⚡, ⚡ or AUTO. This control has only one position in vehicles without fog lights.
- To switch off the fog lights, press the light switch or turn it to position 0.

### **i** Note

The rear fog light can dazzle drivers behind you. You should use the rear fog light only when visibility is very poor.

## Turn signal and main beam lever

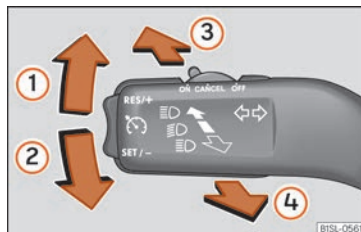

Fig. 80 Turn signal and main beam lever.

Move the lever to the required position:

- ① Right turn light or right-hand parking light (ignition switched off).
- ② Left turn light or left-hand parking light (ignition switched off).
- ③ Main beam on: control lamp ⚡ lit up on the instrument panel.
- ④ Light flash: on with the lever pushed. Control lamp ⚡ lit up.

Push the lever all the way down to turn off the corresponding function.

### Convenience turn signals

When the ignition is switched on, move the lever as far as possible upwards or downwards and release the lever. The turn signal will flash three times.



The convenience indicators can be deactivated at a Specialised workshop.

### Parking light on both sides

- Switch the ignition off.
- Place the light switch in position  $\Rightarrow \Leftarrow$ .
- Lock the vehicle from the outside.

In doing so, only the side lights of both headlights light up, and additionally the tail lights will do so partially.

#### WARNING

Improper or lack of use of the turn signals, or forgetting to deactivate them can confuse other road users. This could result in a serious accident.

- Always give warning when you are going to change lane, overtake or when turning, activating the turn signal in good time.
- As soon as you have finished changing lane, overtaking or turning, switch the turn signal off.

#### WARNING

Incorrect use of the headlights may cause accidents and serious injury, as the main beam may distract or dazzle other drivers.

#### Note

- If the convenience turn signals are operating (three flashes) and the other convenience turn signals are switched on, the active part stops flashing and only flashes once in the new part selected.
- The turn signal only works when the ignition is switched on. The hazard warning lights also work when the ignition is switched off.
- The main beam headlights can only be switched on if the dipped beam headlights are already on.
- In cold or damp weather conditions, the headlights, tail lights and turn signals may mist up inside temporarily. This is normal and in no way effects the useful life of the vehicle lighting system.

### “Coming home” and “Leaving home” function

The “Coming home” and “Leaving home” function lights up the vehicle’s immediate proximity when getting into and out of it in the dark. When switched on, the front position and dipped beam lights, tail lights and license plate light come on.

The “Leaving Home” is controlled by a photo-sensor.

In the vehicle settings menu of the infotainment system you can adjust the duration of the light switch-off delay, and activate and deactivate the function.

#### Activating the “Coming Home” function

- Switch the ignition off.
- Activate the headlight flashers for approximately 1 second.

When the driver door is opened, the “Coming Home” lighting comes on. The delay in switching off the headlights is counted from when the last door or boot hatch is closed.

#### The “Coming Home” lighting turns off in the following cases:

- Automatically, once the headlight turn off delay has elapsed.
- Automatically, when a vehicle door or the rear lid is still open 30 seconds after starting the engine.
- When the rotary light switch is turned to position  $\text{0} \gg \gg$  page 77.
- With the ignition is switched on.

#### Activating the “Leaving Home” function

- Unlock the vehicle using the remote control.
- The “Leaving Home” function is only activated when the light switch is in position **AUTO** and the light sensor detects darkness. **»**

The “Leaving Home” lighting switches off in the following cases:

- Automatically, when the “Leaving Home” delay period ends (default 30 sec).
- When the vehicle is locked using the remote control.
- When the light switch is turned to position 0.
- With the ignition is switched on.

**Note**

To activate the “Coming Home” and “Leaving Home” function, the rotary light switch must be in position AUTO and the light sensor must detect darkness.

**Hazard warning lights** 





**Fig. 81** Dash panel: hazard warning lights switch

The hazard warning lights are used to draw the attention of other road users to your vehicle in emergencies.

If your vehicle breaks down:

1. Park your vehicle at a safe distance from moving traffic.
2. Press the button to switch on the hazard warning lights .
3. Switch the ignition off.
4. Apply the handbrake.
5. Move the selector lever to position P.
6. Use the warning triangle to draw the attention of other road users to your vehicle.
7. Always take the vehicle key with you when you leave the vehicle.

All turn signals flash simultaneously when the hazard warning lights are switched on. The two turn signal turn signal lamps   and the turn signal lamp in the switch  will flash at the same time. The simultaneous hazard warning lights also work when the ignition is switched off.

**WARNING**

The risk of an accident increases if your vehicle breaks down. Always use the hazard warning lights and a warning triangle to draw the attention of other road users to your stationary vehicle.



**Note**

- The battery will run down if the hazard warning lights are left on for a long time, even if the ignition is switched off.
- The use of the hazard warning lights described here is subject to the relevant statutory requirements.

**Light range control**



**Fig. 82** Next to the steering wheel: headlight range control.

The headlight range control  **Fig. 82** is modified according to the value of the headlight beam and the vehicle load status. This offers the driver optimum visibility and the headlights do not dazzle oncoming drivers .

The headlights can only be adjusted when the dipped beam is switched on.

To reset, turn switch »» Fig. 82:

Value	Vehicle load status <sup>a)</sup>
–	Two front occupants, luggage compartment empty
1	All seats occupied, luggage compartment empty
2	All seats occupied, luggage compartment full.
3	Driver only, luggage compartment full

<sup>a)</sup> If the vehicle load does not correspond to those shown in the table, it is possible to select intermediary positions.

## ⚠ WARNING

Heavy objects in the vehicle may mean that the headlights dazzle and distract other drivers. This could result in a serious accident.

- Adjust the light beam to the vehicle load status so that it does not blind other drivers.

## Driving abroad

In those countries where vehicles drive on the other side of the road to the home country, the asymmetric dipped beam may dazzle drivers of oncoming vehicles.

For this reason, stickers may be needed to cover the headlights when driving abroad. For further information, please refer to a specialised workshop. SEAT recommends visiting a technical service.

### **i** Note

The use of stickers to cover headlights is only permitted over a short period. To modify the direction of the headlamps more permanently, please take the vehicle to a specialised workshop. SEAT recommends taking your car in for technical service.

## Interior lights

### Lighting of the instrument panel, displays and switches

When the side lights or dipped beam headlights are switched on, the lighting for instruments and controls lights up at a constant brightness.

## Interior and reading lights

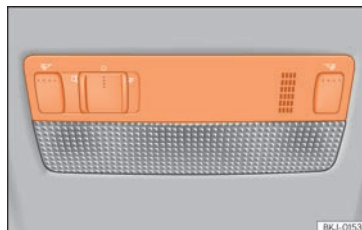

Fig. 83 Detail of roof lining: front lighting of the passenger compartment.

Knob	Function
0	Switching off the reading light.
	Turning the interior lights on or off.
	Door contact connection. The interior lights come on automatically when you unlock the vehicle, open a door or remove the key from the ignition. The light goes out a few seconds after closing all the doors, when locking the vehicle or connecting the ignition.
	Turning the reading light on and off

### Luggage compartment lighting

The light is activated when the rear lid is open, even when the ignition and lights are »

turned off. For this reason, ensure that the rear lid is always closed.

**Note**

If not all the vehicle doors are closed, the interior lights will be switched off after approx. 10 minutes, providing the ignition key has been removed and the courtesy light position selected. This prevents the battery from discharging.

## Visibility

### Windscreen wiper and rear window wiper systems

#### Window washer lever

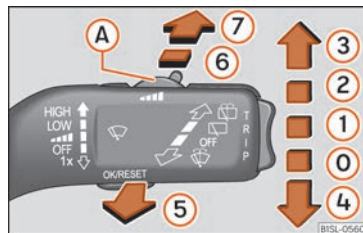

**Fig. 84** Operating the windscreen wiper and rear wiper.

#### More the lever to the required position:

0	<b>OFF</b>	Windscreen wipers off.
1		Wiper intervals. Use control <b>»» Fig. 84 (A)</b> to set the interval (vehicles without rain sensor), or the sensitivity of the rain sensor <b>»» page 83</b> .
2	<b>LOW</b>	Slow wipe.
3	<b>HIGH</b>	Continuous wipe.

#### More the lever to the required position:

4	<b>1x</b>	Short wipe. Brief press, short clean. Hold the lever down for more time to increase the wipe frequency.
5		Windscreen washer. The windscreen washer function is activated by pushing the lever towards the steering wheel, and the wipers operate simultaneously.
6		Interval wipe for rear window. The wiper will wipe the window approximately every six seconds.
7		The rear window wash function is activated by pressing the lever, and the rear wiper starts simultaneously.

#### **WARNING**

In cold conditions you should not use the wash/wipe system unless you have warmed the windscreen with the heating and ventilation system. The windscreen washer fluid could otherwise freeze on the windscreen and obscure your view of the road.

#### **CAUTION**

If the ignition is switched off with the windscreen wipers active, they complete their wipe before returning to the rest position. When switching the ignition back on, the windscreen wiper will continue to operate at the same wiping level. Ice, snow and

other obstacles on the windscreen may damage the wiper and the windscreen wiper motor.

- If necessary, remove snow and ice from the windscreen wipers before starting your journey.
- Carefully lift the frozen windscreen wipers from the glass. SEAT recommends a de-icer spray for this operation.
- Do not switch on the windscreen wipers if the windscreen is dry. Cleaning with the windscreen wipers while dry can cause damage.
- In icy conditions, always check that the wiper blades are not frozen to the glass before using the wipers. In cold weather, it may help to leave the vehicle parked with the wipers in service position »» page 43.

**i Note**

- The windscreen and window wipers only function when the ignition is switched on and the bonnet or rear lid, respectively, are closed.
- The interval wipe speed varies according to the vehicle speed. The faster the vehicle is moving, the more often the windscreen is cleaned.
- The rear wiper is automatically switched on when the windscreen wiper is on and the car is in reverse gear.

**Wiper functions**

**Windscreen wipers performance in different situations**

- If the vehicle is stopped, the activated position temporarily moves to the previous position.
- When wiping at intervals, the intervals vary according to the speed. The higher the vehicle speed the shorter the intervals.

**i Note**

The wiper will try to wipe away any obstacles that are on the windscreen. The wiper will stop moving if the obstacle blocks its path. Remove the obstacle and switch the wiper back on again.

**Rain sensor\***

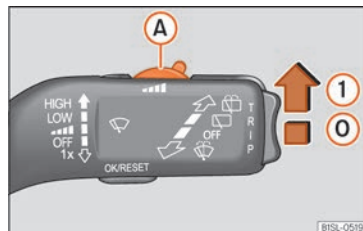

**Fig. 85** Wiper lever: adjust the rain sensor (A)



**Fig. 86** Rain sensor sensitive surface

The rain sensor controls the frequency of the windscreen wiper intervals, depending on the amount of rain »» Δ. The sensitivity of the rain sensor can be adjusted manually. Manual wipe »» page 82.

Move the lever to the required position

»» Fig. 85:

- Rain sensor off.
- ① Rain sensor on; automatic wipe if necessary.
- Ⓐ Setting sensitivity level of rain sensor
  - Set control to the right: high sensitivity.
  - Set control to the left: low sensitivity.

When the ignition is switched off and then back on, the rain sensor stays on and starts operating again when the windscreen wipers are in position ① and the vehicle is travelling at more than 16 km/h (10 mph).



### Modified behaviour of the rain sensor

Possible causes of faults and mistaken readings on the sensitive surface »» Fig. 86 of the rain sensor include:

- Damaged wipers: a film of water on the damaged blades may lengthen the activation time, reduce the washing intervals or result in a fast and continuous wipe.
- Insects: insects on the sensor may trigger the windscreen wiper.
- Salt on the road: in winter, salt spread on the roads may cause an excessively long wipe when the windscreen is almost dry.
- Dirt: dry dust, wax, coating on glass (Lotus effect) or traces of detergent (car wash) may reduce the effectiveness of the rain sensor or make it react more slowly, later or not at all.
- Windscreen crack: the impact of a stone will trigger a single wipe cycle with the rain sensor on. Next the rain sensor detects the reduction in the sensitive surface area and adapts accordingly. The behaviour of the sensor will vary with the size of the damage caused by the stone.

#### **⚠ WARNING**

The rain sensor may not detect enough rain to switch on the wipers.

- If necessary, switch on the wipers manually when water on the windscreen obstructs visibility.

#### **i Note**

- Clean the sensitive surface of the rain sensor regularly and check the blades for damage »» Fig. 86 (arrow).
- To remove wax and coatings, we recommend a window cleaner containing alcohol.
- Do not put stickers on the windscreen in front of the rain sensor\*. This may cause sensor disruption or faults.

## Mirrors

### Interior mirror

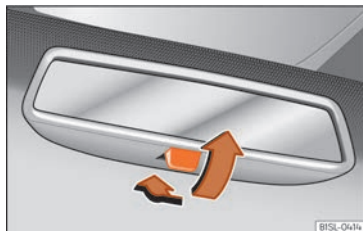
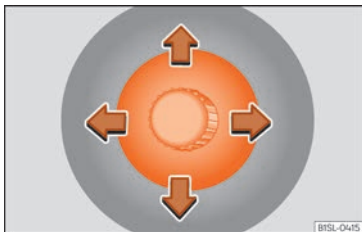

**Fig. 87** Manual anti-dazzle function for rear vision mirror

### Manual anti-dazzle function for interior rear vision mirror

- Basic position: point the lever at the bottom of the mirror forwards.
- Pull the lever to the back to select the anti-dazzle function »» Fig. 87.

## Adjusting the exterior mirrors



**Fig. 88** On the front doors: button to adjust the mechanical exterior rear vision mirror.

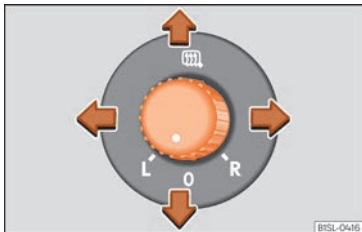

**Fig. 89** On the driver's door: control to adjust the electric exterior rear view mirrors.

The exterior rear view mirrors are adjusted by moving the adjustment control »» Fig. 88 or the rotary control\* »» Fig. 89.

**L/R** By moving the control to the desired position, adjust the rear view mirrors on the

left side [L] and on the right side [R] in the desired direction.

⚠ Depending on the equipment fitted on the vehicle, the mirrors may be heated according to the outside temperature.

### Manually folding the exterior mirrors

Folding in the exterior mirrors and returning them to their original position is possible through a mechanical system. Carefully fold the exterior rear vision mirror casing towards the side window or pull it away from the window until it clicks into place.

#### ⚠ WARNING

Convex or wide-angle\* exterior mirrors give a larger field of vision. However, they make objects look smaller and further away than they really are. If you use these mirrors to estimate the distance to vehicles behind you when changing lane, you could misjudge the distance. Risk of accident!

#### ⚠ WARNING

Fold and unfold the exterior mirror, taking care to avoid injuries.

- Only fold or unfold the exterior mirror when there is no-one in the way of the mirror.
- When moving the mirror, take care not to trap fingers between the mirror and the mirror bracket.

#### ⚠ CAUTION

Before washing the vehicle in an automatic car wash, please make sure to retract the exterior mirrors to prevent them from being damaged.

#### i Note

If the electrical adjustment should fail to operate, both of the mirrors can be adjusted by hand by lightly pressing the edge of the mirror glass.

## Sun protection

### sun blind

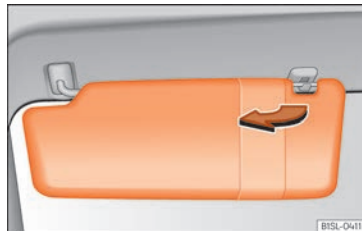

**Fig. 90** Sun visor on the driver side.

### Options for adjusting driver and front passenger sun visors

- Lower the sun visor towards the windscreen.
- The sun visor can be pulled out of its mounting and turned towards the door.
- Swing the sun visor towards the door, longitudinally backwards.

### Vanity mirror\*

There may be a vanity mirror in the folded sun visor on the passenger side and a cardholder in the driver sun visor.

#### **⚠ WARNING**

Folded sun blinds can reduce visibility.

- Always store sun blinds and visors in their housing when not in use.

### Heat-insulating glass windscreen

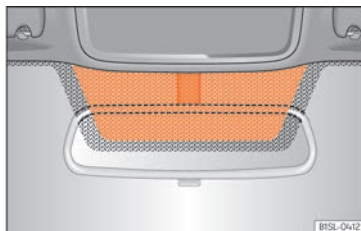

**Fig. 91** Windscreen with reflective infrared and metal coating and small window (red surface)

The heat-insulating windscreens include a reflective infrared coating. The section above the rear vision mirror has been left uncoated (communication window) to allow electric components from the accessories shop to operate correctly »» Fig. 91.

#### **⚠ CAUTION**

When the uncoated surface is covered or has a sticker on the interior or exterior, malfunctions in the electronic components may occur. Never cover the uncoated surface on the interior or exterior.

## Seats and head restraints

### Adjusting seats

#### Manual adjustment of the front seats

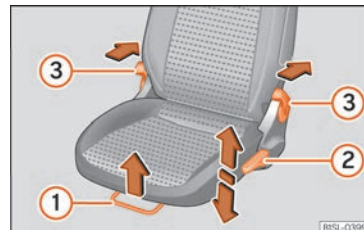

**Fig. 92** Front seats: manual seat settings.

- ① Forwards/backwards: pull the lever and move the seat. The seat must engage when the lever is released!
- ② Raise/lower: pull the lever up or push down (several times if necessary) from its home position.
- ③ Reclining the backrest: press the lever and adjust the backrest inclination at the same time. The seat backrest must be engaged.



### WARNING

Incorrect seat adjustment may lead to accidents and severe injuries.

- Only adjust the seats when the vehicle is stationary, as the seats could move unexpectedly while the vehicle is in motion and you could lose control of the vehicle. Furthermore, an incorrect position is adopted when adjusting the seat.
- Adjust the height, position and inclination of the front seats only when their movement area is empty.
- Make sure there are no objects in that area.
- Make sure that the movement and locking areas of the seats are clean.

## Headrest

### Introduction

The possibilities for the adjustment and disassembly of the headrests are described below. Always make sure that the seats are correctly adjusted »» page 11.

All seats are equipped with a head restraint.

#### Correct adjustment of head restraint

Adjust the head restraint so that its upper edge is at the same level as the top of your

head and under no circumstances below eye level. Keep the back of your head always as close to the head restraint as possible.

#### Adjusting the head restraint for short people

Lower the head restraint completely, even if your head is below its upper edge. In the lowest position, there may be a small distance between the head restraint and the backrest.

#### Adjusting the head restraint for tall people

Push the head restraint up as far as it will go.

### WARNING

If travelling with the head restraints removed or improperly adjusted, the risk of severe or fatal injuries in the event of accidents and sudden braking or manoeuvres increases.

- Always travel with the head restraint correctly installed and adjusted.
- To decrease the risk of cervical injuries in the event of an accident, adjust the head restraint correctly based on your height, always making sure that its upper edge is at the same height as the top of the head, but never below eye level. Keep the back of your head always as close to the head restraint as possible and centred.
- Never adjust the head restraint while the vehicle is in motion.

- Under no circumstances should the rear passengers travel while the head restraints are in the non-use position.

### WARNING

Remove the rear headrests only when it is necessary to fit a child seat. After removing a child seat, refit the headrest immediately.

### CAUTION

When assembling and disassembling the head restraints, do not let them meet the top lining of the vehicle, the back rest of the front seat or other parts of the vehicles. If not, this could damage the vehicle.

## Seat functions

### Folding down and raising the rear seat backrest

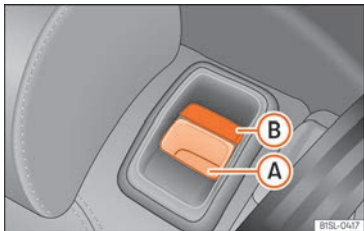

**Fig. 93** Rear seat: unlock button (A); red marking (B).

The rear seat backrest can be folded forward to extend the luggage compartment.

#### Folding the rear seat backrest forwards

- Push the head restraint down as far as it will go or remove it if necessary and store it in a safe place.
- Pull the unlock switch » Fig. 93 (A) forwards whilst simultaneously lifting the rear seat backrest.
- The rear seat backrest is not engaged when the red marking of the button (B) is visible.

- If the rear seat backrest is folded, people (including children) are not permitted to travel in the rear folded seats.

#### Folding up the rear seat backrest

- Lift back the backrest of the rear seat and push it firmly into the lock until it clicks securely into place » » Δ.
- The red marking on the unlock button (B) must not be seen.
- Make sure that the backrest of the rear seat is securely locked in position so that the seat belts can provide proper protection in the rear seats.
- If necessary, reinstall and readjust the head restraints.

#### ⚠ WARNING

**Folding and lifting the backrests of the rear seats carelessly without paying attention could cause serious injury.**

- Never fold or lift the seats while driving.
- Do not trap or damage seat belts when raising the seat backrest.
- Keep hands, fingers, feet and other limbs away from the range of the rear seat backrests when folding and lifting them.
- All seat backrests must engage correctly for the seat belts on the rear seats to work properly. When the backrest of an occupied seat is not correctly locked in place, the passenger can be thrust forward with

the rear seat backrest in case of sudden braking, sudden manoeuvres or an accident.

- A red signal on the button (B) warns that the backrest is not engaged. Always check to make sure that the red mark is not visible when the backrest of the rear seat is in the upright position.
- No seat must be occupied if the backrest of the rear seat is folded or not correctly engaged.

#### ⓘ CAUTION

Before folding the rear seat backrest, adjust the front seats so that neither the head restraint or backrest hit them when folded. If necessary, remove the head restraints and store them safely.

## Transport and practical equipment

### Storing objects

#### Positioning the luggage and cargo

It is possible to transport cargo and luggage in the vehicle and on the roof »» page 92. When doing so, please consider all legal provisions.

#### Placing luggage inside the vehicle safely

- Distribute the load in the vehicle as evenly as possible.
- Always place equipment and heavy objects in the boot »» ⚠.
- Position heavy items in the boot as far forward as possible.
- Take into account the maximum authorised weight per axle, as well as the maximum authorised weight of the vehicle »» page 211.
- Secure the objects to the fastening rings of the boot using appropriate chains or belts »» page 91.
- Also place small objects safely.
- Adapt tyre pressure to the load. Take into account the pressure sticker of the tyres »» page 188.

- In vehicles equipped with tyre control system, adjust to the new load status if necessary »» page 192.

#### ⚠ WARNING

Loose or unsecured objects can cause serious injury in case of sudden manoeuvring or braking or in case of an accident. Particularly if the airbag hits them when deploying and they are thrown across the inside of the vehicle. Please observe the following rules to minimise the risk of injury:

- Place all objects inside the vehicle safely.
- Secure all objects, little and large.
- Place the objects in the cabin in such a way that they can never reach the airbag deployment areas while the vehicle is in motion.
- Keep the storage compartments closed at all times while the vehicle is in motion.
- Place the objects in such a way that they never force any occupant of the vehicle to sit in an incorrect position.
- When transporting objects that take up a seat, never let anyone use that seat.
- Never leave hard, sharp or heavy objects loose in open storage compartment of the vehicle, on the cover behind the rear seat or on the instrument panel.
- Remove all hard, sharp or heavy objects from the fabrics and bags inside the cabin and store them safely.

#### ⚠ WARNING

The transport of heavy object changes vehicle handling and increases braking distance. Heavy objects that are not properly placed or secured may cause loss of control of the vehicle and thus severe injuries.

- Never put too much load in the vehicle. Both the carrying capacity as well as the distribution of the load in the vehicle have effects on the driving behaviour and braking ability.
- When transporting heavy objects, the driving behaviour of the vehicle varies due to the displacement of the centre of gravity.
- Always distribute the load in the vehicle as evenly and horizontally as possible.
- Always place heavy objects in the boot before the rear axle and as far away from it as possible.
- Objects in the luggage compartment that are unsecured could move suddenly and modify the handling of the vehicle.
- Adapt your speed and driving style at all times to suit visibility, weather, road and traffic conditions.
- Accelerate with particular care and caution.
- Avoid sudden braking and manoeuvres.
- Brake earlier than usual.

»

**⚠ WARNING**

- Never leave your vehicle unattended, especially when the rear lid is open. Children could climb into the luggage compartment, closing the door behind them; they will be trapped and run the risk of death.
- Close and lock all the doors and the rear lid when you leave the vehicle. Before you lock the vehicle, make sure that there are no adults or children in the vehicle.

**ⓘ CAUTION**

Electrical wires or, depending on the features, the antenna embedded into the rear windows could be damaged, even irreparably, if they are in contact with objects.

**ⓘ Note**

Straps for securing the load to the fastening rings are commercially available from accessory shops.

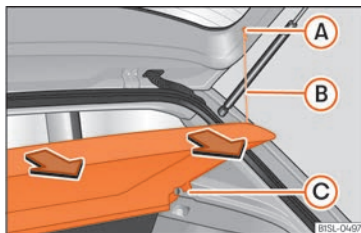
**Luggage compartment****Luggage compartment shelf**

**Fig. 94** In the luggage compartment: removing and fitting the shelf.

**Removing**

- Detach the cord loops »» Fig. 94 (A) from their hooks (A).
- Unclip the shelf from the side supports (C) by pulling it up and removing the shelf.

**Fitting**

- Insert the shelf horizontally to make the "horseshoe" coincide with the axis of supports (C) and press down until it engages.
- Attach the securing straps (B) onto the rear lid.

**⚠ WARNING**

Animals, loose or unsecured objects carried on the rear shelf can cause serious injury in case of sudden manoeuvring or braking or in case of an accident.

- Do not leave hard, sharp or heavy objects or in bags on the rear shelf.
- Never transport animals on the rear shelf.

**ⓘ CAUTION**

- Before closing the rear lid, ensure that the rear shelf is correctly fitted.
- An overloaded luggage compartment could mean that the rear shelf is not correctly seated and it may be bent or damaged.
- If the luggage compartment is overloaded, remove the tray.

**ⓘ Note**

Ensure that, when placing items of clothing on the luggage compartment cover, rear visibility is not reduced.

## Variable luggage compartment floor

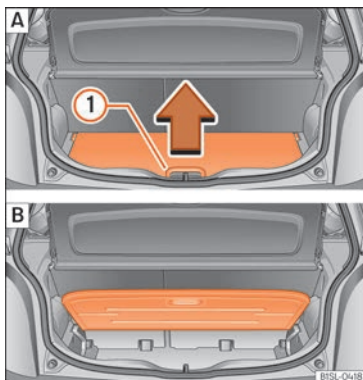

**Fig. 95** Variable luggage compartment floor: **[A]** Raise the adjustable floor; **[B]** adjustable floor raised.

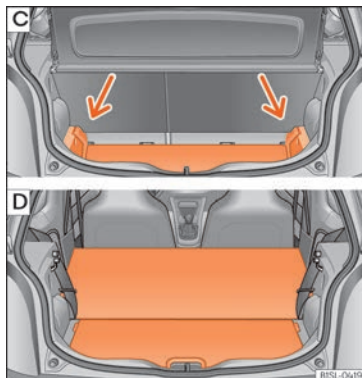

**Fig. 96** Variable luggage compartment floor: **[C]** Enlarge the luggage compartment downwards; **[D]** enlarge the luggage compartment forward.

### Raise and lower the luggage compartment floor

- To raise the floor, lift lever » **Fig. 95 [A]** ① in the direction of the arrow and pull on the floor fully upwards » **Fig. 95 [B]**.
- To lower it, guide the floor downward.

### Extend the luggage compartment downward

- Lift the luggage compartment floor and push it down on the guide » **Fig. 96 [C]** [arrows].

- Place the variable floor over the floor lining.
- If necessary, fold the backrest of the rear seat forward » **page 88**.

### Extending the luggage compartment forward

- Disassemble the luggage compartment tray » **page 90**.
- Remove the rear head restraints.
- Fold the backrest of the rear seat forward » **page 88**.
- If necessary, place the luggage compartment floor at a lower position » **Fig. 96 [C]**.

The luggage compartment is enlarged forward » **Fig. 96 [D]**.

### ⚠ CAUTION

Do not let the luggage compartment floor fall when closing it. Always carefully guide it downward in a controlled manner. Otherwise, the lining and the floor of the luggage compartment could be damaged.

### Fastening rings\*

There are fastening rings on the front and rear of the boot to secure loose objects and luggage with fastening belts and cords. »

**⚠ WARNING**

If unsuitable or damaged belts or retaining straps are used, they could break in the event of braking or an accident. Objects could then be launched across the passenger compartment and cause serious or fatal injuries.

- Always use belts or straps that are suitable and in good condition.
- Tighten the belts and straps in a cross layout over the load placed on the boot floor and secure them to the fastening rings safely.
- Never exceed the maximum tensile load of the fastening rings when securing objects.
- Make sure that, particularly for flat objects, the upper edge of the load is higher than the fastening rings.
- Depending on the features, take into account the instruction panels on the boot on how to place the load.
- Never secure a child seat to the fastening rings.

**i Note**

- The maximum tensile load that the fastening rings can support is approx. 3.5 kN.
- Belts, straps and securing systems for the appropriate load can be obtained from specialised dealerships. SEAT recommends visiting a SEAT dealership for this.

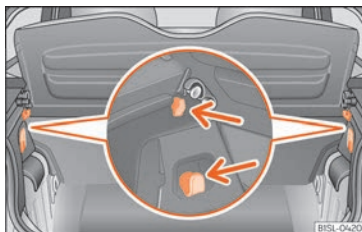
**Bag hooks**

**Fig. 97** In the luggage compartment: bag hooks.

There may be hooks in the upper left and right part of the luggage compartment.

**⚠ WARNING**

Never use these hooks to secure objects. In case of sudden braking or an accident, they could rupture.

**i CAUTION**

The hooks can support a maximum of 2.5 kg each.

**Roof carrier\*****Introduction**

The vehicle roof has been designed to optimise aerodynamics. For this reason, cross bars or conventional roof carrier systems cannot be secured to the roof water drains.

As the roof water drains are integrated in the roof to reduce air resistance, only SEAT-approved cross bars and roof carrier systems can be used.

**Cases in which cross bars and the roof carrier system should be disassembled.**

- When they are not used.
- When the vehicle is washed in a car wash.
- When the vehicle height exceeds the maximum height, for example, in some garages.

**⚠ WARNING**

- Always secure the load properly using belts or retaining straps that are suitable and in a good condition.
- Bulky, heavy, long or flat loads have a negative effect on aerodynamics, the centre of gravity and driving performance.
- Avoid sudden braking and manoeuvres.
- Adapt your speed and driving style at all times to suit visibility, weather, road and traffic conditions.

### ⓘ CAUTION

- Remove the cross bars and the roof carrier system before entering a car wash.
- Vehicle height is increased by the installation of cross bars or a roof carrier system and the load secured on them. For this purpose, check that your vehicle's height does not surpass the headspace limit, for example, for underpasses or for entering garage doors.
- Any cross bars, roof carrier systems or loads secured to them must not interfere with the roof aerial or block the path of the rear lid.
- On opening the rear lid make sure that it does not knock into the roof load.

### 🌿 For the sake of the environment

When crossbars and a roof carrier system are installed, the increased air resistance means that the vehicle uses more energy.

### Securing the crossbars and the roof carrier system

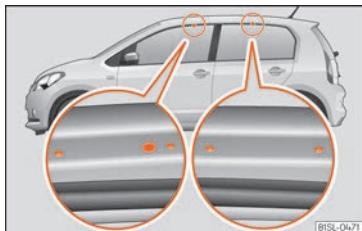

**Fig. 98** Attachment points for the roof railings for the roof carrier system.

The crossbars are the basis of a series of special roof carrier systems. For safety reasons, special fixtures must be used to safely transport luggage, bicycles, skis, surf boards or boats on the roof. Suitable accessories can be acquired at SEAT dealerships.

Always secure the crossbars and the roof carrier system properly. Always take the assembly instructions that come with the crossbars and the roof carrier system in question into account.

The holes or marks indicating the fitting points for base supports are in the lower half of the roof struts and can only be seen with the door open »» **Fig. 98**.

### ⚠️ WARNING

Incorrect attachment and use of the crossbars and the roof carrier system may cause the whole system to detach from the roof and cause an accident and injuries.

- Always take the manufacturer assembly instructions into account.
- Check threaded joints and attachments travelling and if necessary tighten them after you have travelled a short distance. When making long trips, check the threaded joints whenever you stop for a rest.
- Do not modify or repair the crossbars or roof carrier system.

### 📘 Note

Always read the assembly instructions that come with the crossbars and the roof carrier system carefully and keep them in the vehicle.

### Loading the roof carrier system

The load can only be secured if the crossbars and the roof carrier system are properly installed »» ⚠️.

#### Maximum authorised cargo on the roof

The maximum permissible roof load is **50 kg**. This figure comes from the combined weight »»

of the roof carrier, the cross bars and the load itself on the roof »» .

Always check the weight of the roof carrier system, the cross bars and the weight of the load to be transported and weigh them if necessary. Never exceed the maximum authorised roof load.

If you are using cross bars and a roof carrier with a lower weight rating, you will not be able to carry the maximum authorised roof load. In this case, do not exceed the maximum weight limit for the roof carrier which is listed in the fitting instructions.

### Distributing a load

Distribute loads uniformly and secure them correctly »» .

### Check attachments

Once the cross bars and roof carrier system have been installed, check the bolted connections and attachments after a short journey and subsequently with a certain frequency.

#### WARNING

- Never exceed the maximum authorised load on the roof and on the axles or the vehicle's maximum authorised weight.
- Never exceed the load capacity of the cross bars and the roof carrier system,

even if the maximum authorised roof load has not been reached.

- Secure heavy items as far forward as possible and distribute the vehicle load uniformly.

#### WARNING

If the load is loose or not secured, it could fall from the roof carrier system or cause accidents and injuries.

- Always use belts or retaining straps that are suitable and in a good condition.

## Storage compartment

### Introduction

Use the storage compartments only for small or light items.

#### WARNING

Objects in the driver's footwell could difficult the use of the pedals. This may cause loss of control of the vehicle and increases the risk of severe injuries.

- Make sure that nothing prevents you from using the pedals at any time.
- Always secure the mat in the footwell.
- Never place other mats or other type of covers on the factory-fitted mat.

- Ensure that no objects can fall into the driver's footwell while the vehicle is in motion.

- When the vehicle is stationary, remove the objects in the footwell.

#### WARNING

If you leave lighters inside the vehicle, they might be damaged or lit inadvertently. This could lead to severe burns and damage to the vehicle.

- Before moving a seat, make sure there are no lighters in the moving part area of the vehicle.
- Before closing a storage compartment, make sure there are no lighters in the closing area.
- Never leave a lighter inside a storage compartment or any other surface of the vehicle as it could ignite due to the high temperatures on such surfaces, particularly during the summer.

#### CAUTION

- Do not store heat- or cold-sensitive objects, food or medicines in the cabin. Heat and cold could damage them or render them useless.
- Objects made from transparent materials left inside the vehicle, such as glasses, magnifying glasses or transparent suction



pads stuck to the windows can concentrate sunlight and damage the vehicle.

### Glove compartment

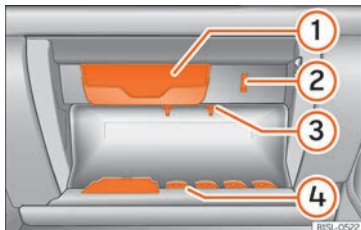

**Fig. 99** On the front passenger side: glove compartment open

- ① Glasses case
- ② Support for a notepad
- ③ Pen holder
- ④ Coin holder

#### Opening and closing the glove compartment

- *Opening:* Pull on the handle and open the glove compartment.
- *Closing:* Press the glove compartment upwards.

### **⚠ WARNING**

If the glove compartment is left open, the risk of causing severe injuries in the event of an accident, sudden braking or manoeuvring increases.

- Always keep the glove compartment closed while the vehicle is in motion.

### Bag support\*



**Fig. 100** Storage compartment on the passenger side: folding hook.

On the glove compartment lever there is a folding hook »»» **Fig. 100** for hanging small pieces of luggage, such as bags, etc.

### **ⓘ CAUTION**

- The maximum weight for the hook is 1.5 kg.

- With the hook folded forward, this automatically folds away when opening the glove compartment.
- We recommend you remove any pieces of luggage hanging from the hook before opening the glove compartment cover.

### Compartment in the front centre console.



**Fig. 101** In the front part of the centre console: storage compartment.

The storage compartment »»» **Fig. 101** can be used to store drinks »»» **page 97**, for the ash-tray\*, or for storing small objects.

### **i Note**

A 12 volt electrical socket »»» **page 97** can be found in the storage compartment.

## Other object holders

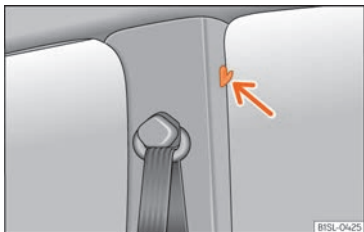

**Fig. 102** On the centre pillars: coat hooks.

You will find more object holders, compartments and supports in other parts of the vehicle:

- Hooks for clothing on the centre pillars  
» **Fig. 102** (arrow).
- On the trims of the front doors.
- Rear shelf for light items of clothing\*.
- Bag hook in the luggage compartment  
» **page 92.**

## Drink holder

### Introduction

#### Bottle holder

The storage compartments of the driver and passenger doors contain a bottle holder.

#### **⚠ WARNING**

Incorrect use of the bottle holders may cause injuries.

- Never put hot drinks in the drink holders. In the event of sudden braking or an accident while driving, hot beverages in the bottle holders might spill and cause burns.
- Ensure that no bottles or other objects are dropped in the driver footwell while driving, as they could get under the pedals and obstruct their working.
- Never place glasses, food or other heavy objects drink holders. These heavy objects may be thrown across the cabin in the event of an accident and cause serious injuries.

#### **⚠ WARNING**

Closed bottles may explode inside the vehicle due to cold or heat.

- Never leave closed bottles in the vehicle if the temperature inside is very high or very low.

#### **ⓘ CAUTION**

Do not leave open cans in the drink holders when the vehicle is in motion. If the drink is spilled (e.g. due to sudden braking) it may damage the vehicle and its electrical system.

#### **ⓘ Note**

The inside elements of the drink holders can be extracted for cleaning.

### Drink holder of the centre console



**Fig. 103** In the front part of the centre console: drinks holder.

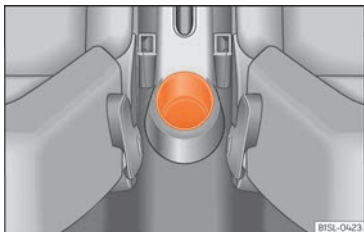

**Fig. 104** In the rear part of the centre console: drinks holder.

There are drink holders in the front and rear parts of the centre console.

### Securing the drink container in the front drink holder

Fold the drink holder »» Fig. 103 forward.

Place the drink container in the drink holder so that it is securely surrounded.

## Power sockets

### Power outlet and USB socket\*



**Fig. 105** Front centre console: 12-volt power outlet on the storage compartment and USB interface.

Electrical equipment can be connected to the socket in the vehicle.

All connected appliances should be in perfect working order without any faults.

### Maximum power consumption

Power socket	Maximum power consumption
12 Volts	120 Watts

The maximum capacity of the socket must not be exceeded. The power consumption is indicated on the rating plate of each appliance.

Where 2 or more appliances are connected at the same time, the total rating of all the connected devices must never exceed 190 Watts »» ⚠.

### 12 volt power socket

The 12 volt socket is located in the storage compartment at the front of the centre console »» Fig. 105 and only works when the ignition is switched on.

With the ignition switched on, the drive system stopped and the electrical appliances switched on, the vehicle's 12-volt battery is discharged. Therefore, electrical devices connected to the socket should only be used when the drive system is operating.

To prevent voltage fluctuations from causing damage, turn off the electrical device connected to the 12-volt socket before connecting and disconnecting the ignition, as well as before starting the drive system. »»

**⚠ WARNING**

Improper use of the socket or electrical devices could lead to a fire and cause serious injuries.

- Never leave children unsupervised in the vehicle. The socket and equipment connected to it can be used when the ignition is switched on.
- Should a connected electrical device overheat, switch it off and unplug it immediately.

**ⓘ CAUTION**

- Take into account the operating instructions of the devices to be connected!
- Never exceed the maximum power rating as this could damage the vehicle's general electrical system.
- To avoid damaging the vehicle's electrical system, never connect accessories supplying power such as solar panels or battery chargers for charging the 12-volt battery to the 12-volt power socket.
- Only use accessories with approved electromagnetic compatibility according to current regulations.
- To avoid damage due to voltage fluctuations, switch off all devices connected to the 12 V power sockets before switching the ignition on or off and before starting the drive system.

- Never connect an appliance to the 12 volt power socket that consumes more than the power indicated in watts. Exceeding the maximum power absorption could damage the vehicle's electrical system.

**ⓘ Note**

- Unshielded equipment can cause interference on the radio equipment and the vehicle's electrical system.
- Interference can occur on the radio's AM waveband if electrical appliances are used near the aerial.

## Smartphone support

### Portable smartphone holder

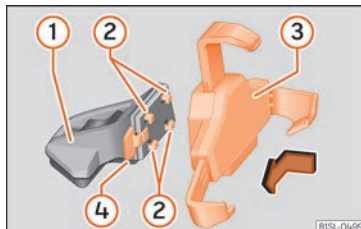

**Fig. 106** Assembling the universal support and the holding arm.

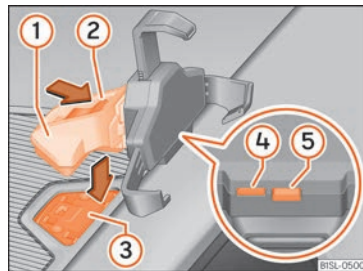

**Fig. 107** In the centre console: close the compartment where the infotainment system is housed.

### Removing the smartphone

- Grip the smartphone firmly with one hand.
- Press the release button **»» Fig. 107 ⑤** until the top arm of the universal holder disengages.
- Remove the smart phone and, as the case may be, unplug any cables.

### Inserting a smart phone

- If necessary, install the smartphone housing **»» ⚠**.
- Connect the smartphone.
- Place the smartphone on the bottom mountings. To adjust the bottom mountings, press button **»» Fig. 107 ④**.

- Press the top arm of the universal holder until the smartphone is securely held in place.

### Disassembling the housing

- If necessary, remove the smartphone.
- Grip the universal holder »» Fig. 106 ③ and press the release button »» Fig. 106 ④.
- Push the universal holder to the right (anti-clockwise) and remove it.
- Grip the holder arm and »» Fig. 107 ① and press the release button »» Fig. 107 ④ in the direction of the arrow.
- Remove the holder from the instrument panel upwards.

### Install the housing

- Insert the universal holder »» Fig. 106 ③ into the slots ② on the holder ①.
- Move the universal holder to the side in the locking direction ④ until it engages audibly »» ⚠.
- Place the holder arm »» Fig. 107 ① in the anchoring plate »» Fig. 107 ③ from above and press down on it until you hear it engage »» ⚠.

#### WARNING

If a smartphone is not secured or is incorrectly secured in the vehicle, it could be flung though the interior during a sudden driving or braking manoeuvre or in the

event of an accident, and could cause injuries.

- The infotainment system holder must be properly secured in the corresponding gap in the instrument panel.
- The infotainment system must always be properly secured in its holder or stored safely in the vehicle.

#### CAUTION

If tilt and angle of visibility are not properly adjusted the smart phone could be damaged.

- When adjusting the smartphone, move it with care and never beyond its limits.

#### CAUTION

At very high or very low temperatures the smartphone might not operate properly, or the actual device could get damaged.

- Take your smart phone with you when you get out of the vehicle to protect it from very high or very low temperatures, and from intense solar radiation.

#### CAUTION

Humidity can damage the electrical contacts for the smartphone on the instrument panel.

- Do not wet the smartphone's housing when cleaning it. Use only a dry cloth.

#### Note

SEAT recommends that you always take your smart phone with you when you get out of the vehicle to avoid possible thefts.

## Air conditioning

### Heating, ventilation and cooling

#### Introduction

The **Climatronic** cools and dehumidifies the air. Its optimum performance is achieved with the windows closed.

To switch a specific function on, press the appropriate button. Press the button again to switch off the function.

The LED on each control lights up to indicate that the respective function of a control has been switched on.

#### Dust and pollen filter

The dust and pollen filter with its activated charcoal cartridge serves as a barrier against impurities in the air taken into the vehicle interior.

The dust and pollen filter must be changed regularly so that air conditioner performance is not adversely affected.

If the filter loses efficiency prematurely due to use in areas with very high levels of air pollution, the filter must be changed more frequently than stated in the Service Schedule.

#### WARNING

Reduced visibility through the windows increases the risk of serious accidents.

- Always ensure that all windows are free of ice and snow, and that they are not fogged, so as to maintain good visibility of everything outside.
- Only drive when you have good visibility.
- Always ensure that you use the air conditioner and heated rear window to maintain good visibility.
- Never leave the air recirculation on for a long period of time. If the cooling system is switched off and air recirculation mode switched on, the windows can mist over very quickly, considerably limiting visibility.
- Switch air recirculation mode off when it is not required.

#### WARNING

Stuffy or used air will increase fatigue and reduce driver concentration possibly resulting in a serious accident.

- Never leave the fresh air fan turned off or use the air recirculation for long periods of time; the air in the vehicle interior will not be refreshed.

#### CAUTION

- To replace the pollen filter, always visit a service centre.

- Switch the air conditioner off if you think it may be broken. This will avoid additional damage. Have the air conditioner checked by a specialised workshop.
- Repairs to the air conditioner require specialist knowledge and special tools. SEAT recommends visiting a SEAT Official Service.

#### Note

- When the cooling system is turned off, air coming from the outside will not be dried. To prevent fogging of the windows, SEAT recommends leaving the cooling system (compressor) turned on. To do this, press the **A/C** button. The button lamp should light up.
- The maximum heat output required to defrost windows as quickly as possible is only available when the engine has reached its normal running temperature.
- Keep the air intake slots in front of the windscreen free of snow, ice and leaves to ensure heating and cooling are not impaired, and to prevent the windows from misting over.
- The air from the vents flows through the vehicle interior and is extracted by slots in the luggage compartment designed for this purpose. Therefore, you should avoid obstructing these slots with any kind of object.

- Do not smoke while air recirculation mode is on, as smoke drawn into the air conditioning system leaves residue on the evaporator, producing a permanent unpleasant odour.

- It is advisable to turn on the air conditioning at least once a month, to lubricate the system gaskets and prevent leaks. If a decrease in the cooling capacity is detected,

a Technical Service should be consulted to check the system.

- When the engine is under extreme strain, switch off the compressor for a moment.

### Climatronic\* controls



**Fig. 108** In the centre console: Climatronic controls.

#### Automatic mode AUTO

Automatic adjustment of temperature, fan, and air distribution. Automatic mode is disabled when the ventilation is modified manually.

#### Cooling mode A/C

Press the button to switch on or off the cooling system.

#### Temperature ①/②

Press buttons ① or ②. The selected temperature is shown on the display of the climate control panel.



#### Blower

The power of the fan is automatically adjusted.

Press the buttons to manually adjust the fan.

#### Air distribution

The airflow adjusts automatically for comfort. It can also be manually distributed to the desired zone by pressing the corresponding button:

-  The airflow is directed towards the chest
-  The airflow is directed towards the footwell.
-  The airflow is directed at the windscreen. »

**Defrost/demist function MAX** 

The air drawn in from outside the vehicle is directed at the windscreen and air recirculation is automatically switched off. To defrost the windscreen more quickly, the air is dehumidified at temperatures over approximately +3°C (+38°F) and the fan runs at maximum output.

**Windscreen heating** 

Press the button to connect and disconnect the windscreen heating with the engine running.

**Heated rear window** 

This only works when the engine is running and switches off automatically after a maximum of 10 minutes.

It should be switched off as soon as the glass is demisted. Lower electricity consumption has a positive effect on energy consumption.

To avoid possible damage to the battery, an automatic temporary disconnection of this function is possible, coming back on when normal operating conditions are re-established.

**Air recirculation** 

» page 103

**Seat heating** 

» page 103

**Switching off**

Press the lower button several times .

**Climate control usage instructions**

The interior cooling system only works when the engine is running and fan is switched on.

**Economic use of the air conditioning**

When the air conditioning is switched on, the compressor consumes engine power and has an influence on energy consumption.

The air conditioner operates most effectively with the windows closed. However, if the passenger compartment has become excessively hot due to being exposed to the sun, it will cool down more quickly by opening the windows for a moment.

**The cooling system cannot be activated**

If the air conditioning system cannot be switched on, this may be caused by the following:

- The engine is not running.
- The fan is switched off.
- The air conditioner fuse has blown.

- The outside temperature is lower than approximately +3°C (+38°F).
- The air conditioner compressor has been temporarily switched off because the engine coolant temperature is too high.
- Another fault in the vehicle. Have the air conditioner checked by a specialised workshop.

**Special characteristics**

If the humidity and temperature outside the vehicle are high, **condensation** can drip off the evaporator in the cooling system and form a pool underneath the vehicle. This is normal and does not indicate a leak!

**Note**

**After starting the engine, any residual humidity in the air conditioner could mist over the windscreen. Switch on the defrost function as soon as possible to clear the windscreen of condensation.**

**Air vents**

To ensure proper heating, cooling and ventilation in the vehicle interior, the air vents must remain open.

- With the fins of the diffusers you can open and close the diffusers, as well as adjust the direction in which you want the air to come



out. To get the best possible air flow towards the windows, open the corresponding diffuser and turn it to the de-icing/demisting position, where it will lock.

There are other additional, non-adjustable air vents in the instrument panel, in the footwells and in the rear area of the passenger compartment.



#### Note

Food, medicine and other heat or cold sensitive objects should never be placed in front of the air outlets as they may be damaged or made unsuitable for use by the air.

### Air recirculation

Air recirculation mode prevents the ambient air from entering the interior.

When the outside temperature is very high, selecting manual air recirculation mode for a short period refreshes the vehicle interior more quickly.

For safety reasons, air recirculation mode is switched off when the button **MAX**  is pressed or the air distributor is turned to .

### Switching the manual air recirculation mode on and off

- Press the button  to connect or disconnect manual air recirculation.

#### WARNING

Observe the safety warnings  in Introduction on page 100.

- If the cooling system is switched off and air recirculation mode switched on, the windows can mist over very quickly, considerably limiting visibility.
- Switch air recirculation mode off when it is not required.

#### CAUTION

Do not smoke when air recirculation is switched on in vehicles with an air conditioner. The smoke taken in could lie on the cooling system vaporiser and on the activated charcoal cartridge of the dust and pollen filter, leading to a permanently unpleasant smell.

#### Note

When reversing, and while the windscreen wipers are running, air recirculation is activated to prevent exhaust gases or unpleasant odours from entering the passenger compartment.

#### Note







If the temperature regulator is turned to the coldest setting (blue point), the air recirculation function and the A/C button are automatically activated.

- If the function is not deactivated by pressing the button, it will deactivate after approximately 20 minutes.

### Seat heating\*

With the engine on, the seat cushion and the seat backrest can be heated electrically.

#### Control seat heating

- Press buttons  or  on the control panel to turn on the seat heating as high as possible.
- Press buttons  or  repeatedly to adjust it to the required level.
- To turn off the seat heating, press button  or  repeatedly until no LEDs are lit.

When the seat heating is at the maximum level, after approx. 15 minutes it is automatically adjusted to the first level.

#### Cases in which the heat seating should not be switched on

Do not switch the seat heating on if any of the following conditions are met: »

- The seat is not occupied.
- The seat has a cover.
- A child seat has been installed on the seat.
- The seat cushion is wet or damp.
- The outdoor or indoor temperature is greater than +25°C (77°F).

### WARNING

People who cannot perceive pain or temperature because of medications, paralysis or chronic diseases (e.g. diabetes) or have a limited perception of these, may suffer burns to the back, buttocks or legs when using seat heating.

- People with limited pain and temperature thresholds must never use seat heating.
- If an abnormality in the device's temperature control is detected, have it checked by a specialist workshop.

### WARNING

If the fabric of the cushion is wet, this can adversely affect the operation of the seat heating, increasing the risk of burns.

- Make sure the seat cushion is dry prior to using the seat heater.
- Do not sit on the seat with clothing that is wet or damp.
- Do not leave clothing that is wet or damp on the seat.
- Do not spill liquid on the seat.

### CAUTION

- To avoid damaging the heating elements of the seat heaters, please do not kneel on the seat or apply sharp pressure to a single point on the seat cushion or backrest.
- Liquids, sharps objects and insulating materials (e.g. covers or child seats) can damage the seat heating.
- In the event of smells, switch off the seat heating immediately and have it inspected by a specialised workshop.

### For the sake of the environment

The seat heating should remain on only when needed. Otherwise, it is unnecessary energy consumption.

## Stationary air conditioning

### Introduction

With the stationary air conditioning you can cool, ventilate and heat the passenger compartment while the vehicle is parked. In winter, you can also demist the windscreen and leave it free of ice and snow (if the layer is thin). The stationary air conditioning receives the necessary energy from the vehicle's high-voltage battery or from the electrical network through a power socket.

With the ignition off, you can manually connect and disconnect the stationary air conditioning with the corresponding application installed on a mobile phone. On the Internet you can check out information about the application, its availability and the necessary requirements for its use, as well as on compatible terminals.

### CAUTION

Never place food, medicines or other temperature-sensitive objects close to the air vents. Food, medicines and other objects sensitive to heat or cold may be damaged or made unsuitable for use by the air coming from the vents.

### Note

If the stationary air conditioning is used without the charging cable plugged in, power is consumed from the high-voltage battery. At extreme temperatures, it is possible that the heating or cooling power of the stationary air conditioning is insufficient to reach the set temperature.

## Managing the stationary air conditioning

The stationary air conditioning can be switched on and off manually (heating, ventilation or immediate cooling) or by means of a

few pre-programmed departure times. The stationary air conditioning is managed through an application installed on a mobile phone.

### Managing the stationary air conditioning

- Automatically by programming and activating a departure time.
- Manually with the corresponding application installed on a mobile phone and the ignition off.

### Managing the stationary air conditioning

- Press the **A/C** button on the air conditioning control panel.
- Automatically at the scheduled departure time or after the programmed operating time has elapsed.
- Automatically when the charge level of the high-voltage battery drops too low  
»» page 158.
- Manually with the corresponding application installed on a mobile phone.

### Air conditioning operating time

The operating time may vary depending on the type of control and the status of the high-voltage battery (whether it is charging or not).

#### *In the event of manual control*

- Charging connector plugged in. 15 minutes
- Charging connector not plugged in. 10 minutes

#### *In the event of a scheduled departure time*

- Charging connector plugged in. 30 minutes of pre-run time
- Charging connector plugged in. 15 minutes of post-run time
- Charging connector not plugged in. 15 minutes of pre-run time
- Charging connector not plugged in. 5 minutes of post-run time

### Operation without the charging connector plugged in

The operation of the stationary air conditioning must be activated with the mobile phone if the charging connector is not plugged in. This setting is memorised in the vehicle.

The stationary air conditioning will not start even if it has been programmed if the option that allows air conditioning without the charging connector being plugged in has not been activated.

When the charging connector is not plugged in, the stationary air conditioning receives the necessary electrical power from the high-voltage battery.

### Operation with the charging connector plugged in

When the charging connector is not plugged in, the stationary air conditioning receives the necessary electrical power from the high-voltage battery. The operating possibilities of the stationary air conditioning depend on the type of charging process:

- *Charging with alternating voltage (charging with AC):* The vehicle can only be charged or heated. If a departure time has been programmed, the high-voltage battery is charged first and the passenger compartment is then heated or cooled. The charging process is prolonged if the stationary air conditioning is manually connected with the corresponding application installed on the mobile phone.
- *Charging with direct current (charging with DC):* The vehicle can only be heated/cooled during the charging process. The charging station may be disconnected as soon as the high-voltage battery is fully charged. The passenger compartment will only be heated/cooled if the air conditioning option without external power is activated.

If a departure time has been programmed through the corresponding application, the vehicle will calculate the previous time that the stationary air conditioning needs. It can be a maximum of 30 minutes.

»

### Programming a departure time

What is programmed is the desired temperature in the passenger compartment for the planned departure time. Starting from the desired temperature, the vehicle calculates the time necessary to reach it and, therefore, the time at which the stationary air conditioning has to be connected. It is possible to schedule up to three departure times.

### Maximum cooling or heating power

The maximum cooling or heating power can be adjusted by the corresponding application installed on a mobile phone.

- *Maximum cooling power:* set the temperature below +18 °C (+64 °F).
- *Maximum heating power:* set the temperature above +28 °C (+82 °F).

When the maximum cooling or heating power is set, the temperature is adjusted. Therefore, depending on the outside temperature, the opposite function may briefly turn on.

Thus, for example, if the stationary air conditioning has been set to the maximum cooling power, the heating may be switched on if the outside temperature is too low. The red silhouette of a vehicle will be shown on the display while the function opposite to the adjusted one is active.

So, if the stationary air conditioning has been set to the maximum heating power, the cool-

ing system may be switched on if the outside temperature is too high. The blue silhouette of a vehicle will be shown on the display while the function opposite to the adjusted one is active.

#### Note

- **If the charge level of the high-voltage battery drops excessively, the stationary air conditioning switches off automatically or cannot be switched on.**
- **Noises will be heard while the stationary air conditioning is running.**
- **The longer or the more often the stationary air conditioning is used without external power, the more the high-voltage battery will be discharged.**

# Infotainment System

## Introduction

### Safety warnings

#### Safety warnings regarding the Infotainment system

Only operate the infotainment system and its various functions when the traffic situation really permits this.

#### WARNING

- Before starting the trip, you should familiarise yourself with the different infotainment system functions.
- High audio volume may represent a danger to you and to others. Hearing may be impaired if the volume is too high, even for short periods of time.
- Changes to the Infotainment system settings should be made when the car is stopped, or by a passenger.

#### WARNING

Current traffic requires maximum attention from public road users. Distracting the driver in any way can lead to an accident and cause injuries. Operating the Infotainment

system can distract your attention from the traffic.

- Always drive carefully and responsibly.
- Select volume settings that allow you to hear sounds from outside the vehicle at all times (e.g. emergency services sirens and horns).

#### WARNING

The volume level may suddenly change when you switch audio source or connect a new audio source.

- Lower the basic volume before connecting or switching audio sources.

#### WARNING

The driving recommendations and traffic indications shown on the navigation system may differ from the current traffic situation.

- Traffic signs and traffic regulations have priority over the recommendations and displays provided by the navigation system.

#### WARNING

Connecting, inserting or removing a data medium while driving can distract your attention from the traffic and cause an accident.

#### WARNING

Place the connecting cables of external equipment so that they do not interfere with the driver's mobility.

#### WARNING

External devices that are loose or not properly secured could move around the passenger compartment during a sharp manoeuvre or accident.

- Avoid placing external devices on the doors, windscreen, steering wheel, instrument panel, the backs of the seats, on top of or near the area marked "AIRBAG" or between these areas and the occupants. They could cause serious injury in an accident, especially when the airbags inflate.

#### WARNING

The armrest\* must always remain closed during the journey as it could restrict the driver's movements.

#### CAUTION

The Infotainment system can be damaged by the incorrect insertion of a data storage device or the insertion of an incompatible data storage device.

- When inserting a data storage device, make sure it is correctly positioned.



- Applying force may irreparably damage the memory card slot locking mechanism.
- Only use compatible memory cards.

### ⓘ CAUTION

The vehicle loudspeakers may be damaged if the volume is too high or the sound is distorted.

### ⓘ Note

For the proper functioning of the Infotainment system it is important that the date and time set in the vehicle are correct.

## Overview of the unit

### You&Mii Colour Connection

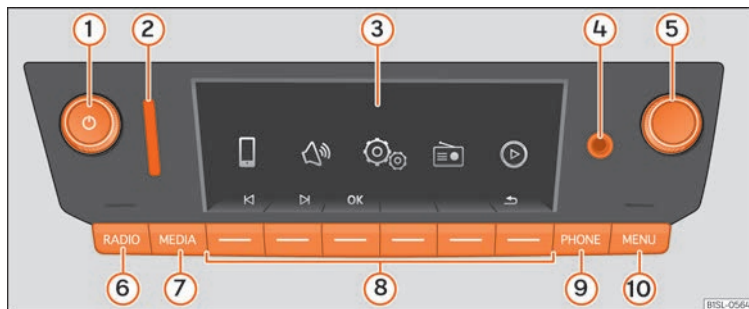



Fig. 109 Overview of the controls

- ① Volume. Off and on »» page 111, »» page 111
- ② Slot for SD cards »» page 122
- ③ Screen
- ④ AUX-IN multimedia socket »» page 124
- ⑤ Settings button (search and selection) »» page 111
- ⑥ Radio mode (change of band frequency) »» page 115
- ⑦ Media mode (audio sources) »» page 120
- ⑧ Function buttons »» page 111
- ⑨ Telephone mode »» page 125
- ⑩ Selecting the main menu »» page 110 »

## Main menus

- To access the main menu, press button .
- To select a function, rotate the setting Button  until it is highlighted and press the set button.

### **Radio** »»» page 115

- RADIO main menu »»» page 115
- RDS »»» page 115
- TP function »»» page 116
- Changing frequency band »»» page 117
- Changing station »»» page 117
- Presetting stations »»» page 118
- Choosing memorised stations »»» page 118
- Digital radio mode »»» page 118

### **Media** »»» page 120

- Media sources and audio files »»» page 120
- Playback order »»» page 121
- Select a Media source »»» page 121
- SD card »»» page 122
- USB port »»» page 123
- Bluetooth »»» page 123
- AUX-IN jack »»» page 124
- Track information »»» page 125
- Changing the playback mode »»» page 125

### **Telephone** »»» page 125

- Connection and operation »»» page 125
- Functions of the phone »»» page 126
- Favourites »»» page 127
- Call by telephone »»» page 127
- Settings of a connected phone »»» page 127

### **Drive Mii App\*** »»» page 128

- Connection and operation »»» page 128

### **Sound**

- Sound and volume settings »»» page 112

### **Setup**

- System and function settings »»» page 112



## General instructions for use

### Additional instructions

Depending on the vehicle, notifications of the factory-fitted driving assistance systems are shown on the display. The notifications close automatically when they are no longer useful.

All notifications are only displayed after completely resetting the radio system.

#### Note

- Pushing the buttons gently is enough to use the equipment.
- Due to country-specific legislation, certain functions may not be available when the vehicle is travelling above a certain speed.
- Using a mobile telephone inside the vehicle may cause noise in the speakers.
- On some vehicles with ParkPilot, the volume of the active audio source is automatically lowered when reverse gear is selected.

## Rotary push buttons, equipment and function buttons

### Overview

- Rotary push buttons.
- **Equipment buttons** named (physical buttons).
- **Function buttons** (virtual buttons).

### Rotary push buttons

The left-hand rotary push button  is known as volume control or the on/off button.

The right-hand rotary push button is known as the settings button.

### Equipment buttons and function buttons

The named buttons of the equipment are known as "equipment buttons" and are shown with a button symbol inside a rectangle, for instance, equipment button .

Unnamed equipment buttons are located below the display. These equipment buttons are known as "function buttons" as their purpose depends on the active function mode.

The function assigned to a function button is explained on the bottom of the display, above the corresponding button.

## Switching on and off

- To manually switch the system on and off, briefly press the rotary push button .

When the unit is switched on the system starts up. The last active audio source will be played with the set volume, as long as this does not exceed the maximum, predefined "switch-on" volume ().

Depending on the equipment and country, when switching off the engine or removing the key from the ignition, the system switches off automatically. If the system is switched on again without switching on the ignition, it will switch off automatically after approximately 30 minutes (switch-off delay).

### Energy management

If the charge of the battery goes below the minimum onboard charge with the ignition switched off and the system active, an audible warning will be emitted and the **LOW BATTERY** message will be displayed. If this happens, you should turn off the equipment.

### Anti-theft password

The password of the anti-theft coding system is stored in the system after entering it for the first time (radio convenience coding). If you have to enter the anti-theft password manually, for instance, because the system has



been installed in a different vehicle, please go to an authorised SEAT dealer.

If only the battery was disconnected, switch on the ignition before turning the system on again.

## Change basic volume



**Increase the volume:** turn the volume control  clockwise.

**Decrease the volume:** turn the volume control  anticlockwise.

Changes in basic volume are indicated by a “volume bar” on the display, which appears briefly.

It is possible to preset certain volume settings and adjustments.

### Mute system sound

- Turn the volume control  anti-clockwise until it displays .
- OR:** press the volume control  briefly to mute or unmute the system.

While the sound of the system is muted (MUTE), the playback Media source stops.



### Note

**If the basic volume has been considerably increased to play a certain audio source,**

**lower the volume again before switching to another audio source.**

## System and function settings (SET-UP)

### Displaying menus settings and changing settings

- Press the button .
- Select the desired adjustment range using the adjustment button and confirm by pressing lightly.
- Select the submenu using the setting button.
- Select the desired adjustment using the setting button.
- Confirm the changes by lightly pressing the setting button.
- Press the device button , function button  to close the *SETUP* menu.



While changing the volume settings, the audio source being played will be heard with the settings you choose.

### Available adjustment menus display

The settings that can be selected varies depending on the country and the equipment in question, and on the vehicle's equipment.

## Menu option: submenus with repercussion

**Radio Settings:** Settings are made here that affect Radio mode.

**Arrow keys:** Set the behaviour of the arrow keys  and  for changing stations in Radio mode  page 115.

**Preset list:** The arrow keys are used to switch between all of the **saved** stations in the selected frequency band.

**Station List:** The arrow keys are used to switch between **all** of the available stations.

**Traffic programme (TP):** Traffic station announcements  page 116.

**Radio text:** Radio text display

**Delete memories:** Delete stored stations.

**Delete all:** Delete all stored stations.

Selecting a special memory only deletes some stations. Memories that contain a station are visibly highlighted, identified with a frequency and have a rubbish bin symbol at the end of the line.

**FM station list<sup>a1</sup>:**

**Alphabetically:** In alphabetical order.

**Group:** Sorted by groups.

**Advanced FM settings:**

**RDS regional<sup>b1</sup>:** In areas without RDS coverage, services requiring RDS may be deactivated (e.g. automatic station tracking)  page 115.

## Menu option: submenus with repercussion

**Automatic:** Automatic change to a regional RDS programme.

**Fixed:** Stations that support RDS are selected manually.

**Automatic frequency change (AF):** Automatic station tracking » page 115.

If the function is active, while driving it is always changed to the frequency of the tuned radio station, which at that time is better tuned. This happens even if a tuned regional broadcast is interrupted.

If the function is disabled, the frequency change is not performed. The tuned frequency remains active until reception is interrupted.

## Advanced DAB settings:

**DAB traffic announcements:** If there are alerts of a traffic station available, they are played directly in the active Radio DAB mode. Traffic announcements of an FM traffic information station are ignored. If this function is disabled, or if the current DAB ensemble does not offer a TP service, the traffic announcements of an FM traffic station are played directly in the active Radio DAB mode » page 116.

**Other DAB announcements:** DAB announcements (news, sports information, weather, warnings, etc.) are played while the DAB Radio mode is active.

## Menu option: submenus with repercussion

**DAB - DAB station tracking:** Automatic station tracking in Radio DAB mode. If the tuned DAB station broadcasts on another channel when you change location, it automatically switches to that channel (factory setting).

**DAB - FM automatic switching:** Switching to the FM frequency band is permitted for automatic station tracking » page 114.

**Media settings:** Here you can set the Media mode settings.

**Mix / Rep. incl. subfolders:** It states that random play and repeat play may include possible existing subfolders. The setting only affects the playback of MP3/WMA files.



**Selecting Bluetooth device:** Selection of the Bluetooth device to be used for playback or for telephony.

**Application connection:** The settings of this menu option are only available when a device is connected.



**Phone settings:** Settings for pairing with a Bluetooth® compatible smartphone.

## Sound settings:

## Volume:

**Maximum switch-on volume:** Here you can set the volume that must be adjusted when the equipment is turned on. For adjusting use the  and  buttons or the setting button.

## Menu option: submenus with repercussion

**Warnings:** Here you can set the volume of traffic station announcements (TP). For adjusting use the  and  buttons or the setting button.

**Speed-dependent adjustment:** The speed-dependent volume increase function automatically adjusts the volume based on the speed of the vehicle » page 114.

**AUX VoLume:** To adapt the **input volume** of an **external audio source (AUX)** to the **playback volume** of the other audio sources.

**BT Audio:** To adapt the **input volume** of an **external audio source (Bluetooth®)** to the **playback volume** of the other audio sources.

**Balance - Fader:** To adjust the sound distribution.

**Bass - Mid - High:** To adjust the sound properties.

## System Settings:

## Screen:

**Switch off screen (in 10 seconds):** The screen turns off automatically when no operation is performed during the set time. As soon as one of the device buttons, function buttons or rotary controls is activated, the display will be active again and will show the last active dialogue.

**Brightness:** Screen brightness selection from **Maximum brightness** to **Maximum darkness**.



## Menu option: submenus with repercussion

**Show clock in standby mode:** When the device is turned off, the current time is shown on the display.

**Colour:** Here you can select marking colours for the screen.

**Language:** Here you can manually set the desired language for the user interface. Alternatively, you can let the instrument panel language be automatically selected.

### Bluetooth:

**Bluetooth:** Press to switch off Bluetooth®. All existing connections are disconnected.

**Visibility:** Switch Bluetooth® visibility on and off.

**Visible:** Bluetooth® visibility is switched on.

**Not visible:** Bluetooth® visibility is switched off. Bluetooth® must be switched on for pairing a Bluetooth® device with the infotainment system.

**Forename:** Display or change the name of the device. This name will be displayed to other Bluetooth® devices in their Bluetooth® settings.

**Paired devices:** Viewing paired devices. Switching Bluetooth® devices and individual Bluetooth® profiles on and off.

**Searching for a device:** Search for visible Bluetooth® devices that are within range of the infotainment system. The **maximum** range is approx. **10 meters**.

## Menu option: submenus with repercussion

**BT Audio (A2DP/AVRCP):** If an external audio source is to be connected to the infotainment system via Bluetooth®, this function must be switched on» page 123.

### Application connection

**Data transfer active**

**Registry**

**Remove source safely:** With this option you can safely remove an inserted SD card or a connected USB device.

**Factory settings:** You can restore the factory settings of **Radio, Media, Sound** and **System** separately or together.

**System information:** Status of technical data of the device.

**Copyright:** Data of the software used.

<sup>a)</sup> Valid only for the FM frequency band.

<sup>b)</sup> This depends on the country and device in question.

## Operation of speed-dependent volume increase

The speed-dependent volume increase function automatically adjusts the volume based on the speed of the vehicle.

The volume increase can be adjusted in levels from **1** to **7**.

If the selected level is low, the volume only increases slightly when the speed increases, if on the contrary it is high, the volume increases considerably. On **0** the speed-dependent volume increase is disconnected.

## DAB-FM LINK operation

If the DAB station being listened to can no longer be tuned in (e.g., there is no DAB coverage), the device will try to find and tune the same station on the FM frequency band.

To allow automatic station tracking on all frequencies, the DAB station and the FM station need to broadcast the station identification, or to signal through DAB which FM station corresponds to the same DAB station.

When the corresponding FM station has been found, **(FM)** is displayed behind the name of the station. If the corresponding DAB station becomes available again, it returns to DAB mode after a while.

If the signal is too weak and the DAB station in question cannot be found again in the FM band, the radio sound is muted.

## Operating modes

### Radio

#### Introduction

The radio system is supplied in different versions depending on the country and the features of the vehicle. Some systems also have a DAB radio receiver. The control overview contains the possible versions of the system »» page 109.

#### Note

- Bear in mind that being in underground parking lots, in tunnels, in areas with tall buildings or mountains can interfere with radio signals.
- Foil or metal-coated stickers attached to the windows may affect reception on vehicles with a window aerial.

#### RADIO main menu



**Fig. 110** RADIO main menu: selecting the frequency band.



**Fig. 111** RADIO main menu: Indication of preset buttons.

- Press equipment button **RADIO** so start the Radio mode.

After switching to Radio mode, the available frequency bands (FM, AM<sup>1)</sup> and DAB<sup>1)</sup>) will be shown on the bottom of the display. Press the

**RADIO** equipment button gain to display more functions for the radio receiver.

The following options are available:

- Search next station.
- Access a previously saved station.
- Switching the TP function on and off
- Save current station »» page 118.

The current station is shown in the middle of the display. If the station allows for RDS and the connection is good, instead of the frequency, the name of the station will be shown, e.g. **RADIO 21**.

#### RDS and automatic station tracking

RDS is a radio data service that enables to display station names, automatic station tracking and TP function (traffic information station »» page 116).

With automatic station tracking, while driving the equipment will switch to the frequency of the radio station you are listening to that currently tunes better. If the tuning is bad, the volume of the equipment may be briefly suppressed while checking the alternative frequencies (AF).

<sup>1)</sup> This depends on the country and unit in question.

RDS is not available in all places or on all radio stations.

Depending on the country and the equipment, RDS and switching to alternative frequencies (AF) can be deactivated in the system settings » page 112.

## TP function (traffic information station)



Fig. 112 TP function activated.

The TP function is an RDS radio data service » page 115. If your equipment is fitted with DAB » page 118, you can also use the TP function without having RDS » page 116.

Using the TP function to track traffic information is only possible if a station providing traffic information can be tuned.

If the tracking of a traffic station is active (indication: **TP** » Fig. 112) traffic announcements are played directly in Audio mode.

Tracking of traffic stations is **not** possible in the AM frequency band <sup>1)</sup>.

Some stations without their own traffic information support the TP function by broadcasting traffic information from other stations (EON). Traffic announcements of the corresponding traffic station are played directly during the active audio mode.

### Activating and deactivating the TP function

- Press the **TP** function button.

If the **TP** function is activated in areas where **there is no support for TP**, the following warning will appear on the screen: **NO TP**.

- Press the **TP** function button again to deactivate the TP function again.

### TP function active

While the traffic station tracking is active and ready for operation, in the FM mode the **TP** » Fig. 112 function button is displayed.

In **Radio mode** the station being listened to must support the TP function, or there must

be a DAB or EON station available that supports the TP function. If neither of the requirements are met, it is not possible to track the traffic station.

If the traffic station being listened to can no longer be tuned, you will have to start a manual search using the arrow buttons **◀** and **▶** » page 115.

If you search for a station using the arrow buttons, the **NO TP** indication appears if the station currently tuned is not compatible with TP.

In **Media mode** or while the equipment volume has been suppressed (mute), a traffic station is automatically tuned in the background, as long as the station has a good signal. Depending on the situation, this operation may take some time.

### Incoming traffic announcement (INFO)

In Audio mode, traffic announcements are played directly when they are received.

- If necessary, the radio gives way to the traffic station (EON) while the announcement is playing.
- Media mode is interrupted and the volume is set as adjusted.

<sup>1)</sup> This depends on the country and unit in question.

- The volume of the traffic announcements can be changed with the volume control . This setting will also apply for subsequent announcements.
- A pop-up message appears that allows you to cancel the traffic announcement (**Cancel**) or deactivate the TP function (**Deactivate**).

## Changing frequency band

The frequency band selected (FM, AM<sup>1)</sup> or DAB<sup>1)</sup>) is shown on the top left.

- In Radio mode, press the **RADIO** equipment button briefly to display the **FM**, **AM**<sup>1)</sup> and **DAB**<sup>1)</sup> function buttons **>>> Fig. 110**.
- Press one of the function buttons **FM**, **AM** or **DAB** to change the frequency band.
- **OR:** Press the **RADIO** equipment button a few times to cycle through the different lower function buttons.

## Changing station



**Fig. 113** Go to the next available station with the arrow buttons.



**Fig. 114** Changing the stations with the arrow buttons is only possible for saved stations.

- Press the or arrow button on the system or the display.

Based on the mode selected for the search mode (**Arrow buttons:**) you can cycle through either available or saved stations.

## Manually tuning a station frequency

- To select the desired frequency band **>>> page 115**.
- Press the function button of the frequency band **FM**.
- Rotate the setting button until the desired frequency is shown on the display (e.g. **89.9 MHz**).
- **OR:** Press one of the double-arrow buttons **>>> Fig. 116** until the frequency is shown on the screen.

<sup>1)</sup> This depends on the country and unit in question.

## Storing the station on the preset buttons



**Fig. 115** Station on the FM frequency band stored in preset button 6.



**Fig. 116** Additional radio functions.

Stations that are already saved are overwritten if another station is stored in the same preset button.

### Assigning different preset buttons manually

- Select the frequency band »» page 117.
- Select station »» page 117.

- Change to preset buttons. To do this, press button »» Fig. 117
- **Press and hold** the desired preset button until an audible signal is heard.
- The current station (**RADIO 21**) will be saved in this preset button.

You can update the station list by pressing and holding the equipment button or using the function button »» Fig. 116.

## Choosing memorised stations



**Fig. 117** Radio mode indication: changing the station using the arrow buttons.



**Fig. 118** Saved stations.

- Select the frequency band on which the station is saved.
- Press the function button.
- **Press** the preset button in which the station is saved briefly.

Depending on the settings, you can cycle through the stations of a frequency band with the arrow buttons and (**Arrow buttons**:).

The stored stations can only be played if they can be received at the current location.

## Digital radio mode\*

### Introduction

Some systems also have a DAB radio receiver.



The DAB radio tuner supports the DAB, DAB + and DMB audio transmission standards.

The digital radio in Europe is transmitted through band III frequencies (from 174 MHz to 240 MHz) and of band L (from 1,452 MHz to 1,492 MHz).

The frequencies of both bands are called “channels” and have an abbreviation (e.g. **12 A**).

In a channel, several available DAB stations are grouped together in an “ensemble”.

DAB radio is **not currently available everywhere**. DAB radio mode displays  in the areas without DAB coverage. In the system and function settings, it is possible to enable changing to an FM station for this case **»» page 112**. In the system and function settings, other settings can be configured for station tracking and for the reproduction of DAB announcements.

### Note

Stations are responsible for the information they transmit.

## Operation



**Fig. 119** RADIO main menu: Selecting memory level and frequency band.



**Fig. 120** RADIO main menu: Indication of preset buttons.

### Starting the DAB radio mode

- Press the button .
- Press the  **»» Fig. 119** function button to open DAB Radio mode.

After switching to DAB radio mode, the available frequency bands (FM, AM<sup>1)</sup> and DAB<sup>1)</sup> will be shown on the bottom of the display **»» Fig. 119**. After about 5 seconds the “preset keys” **»» Fig. 120** are displayed instead.

The centre line of the screen displays the last DAB radio (**RADIO 21**) tuned and it is played, if it can still be tuned in the current location. The ensemble currently selected (**DAB 5**) is shown on the top line of the screen **»» Fig. 120**.

### Changing the DAB and Autostore radio station

This is operated in the same way as described for FM and AM Radio mode<sup>1)</sup> **»» page 115**.

### Manually changing the DAB frequency band channels

- Turn the adjustment knob.

The selected channel is displayed in the centre of the screen. If the selected channel broadcasts a DAB ensemble, its name will be displayed at the top of the screen and the first DAB station of that ensemble will be played.

<sup>1)</sup> This depends on the country and unit in question.

## Starting the station update



Fig. 121 Additional DAB functions

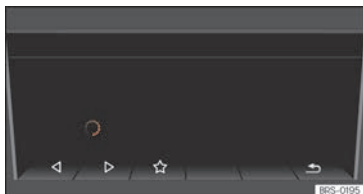





Fig. 122 Active station update.

During the station update, the equipment searches for the available station ensembles in the place where it is located.

- In the preset button view, press the function button  »» Fig. 120 to display the additional functions available »» Fig. 121.
- Press the function button  »» Fig. 121, the message that the station update is active is displayed on the top bar of the screen »» Fig. 122.

- The station update may take a few seconds. The station update ends when the indication  disappears.

During radio update the sound of the radio is suppressed.

## Media

### Introduction

“Media sources” are audio sources containing audio files on various different data storage devices (e.g. external MP3 player). These audio files can be played with their corresponding applications or the radio’s audio inputs.

#### Note

- Do not use memory card adapters.
- SEAT assumes no liability for any deterioration or loss of files on data storage devices.

### Requirements for Media sources and audio files

#### Limitations and indications

Dirt, high temperatures and mechanical damage can cause data media to fail. Con-

sider the indications provided by the manufacturer of the data media.

Consider copyright legislation!

The configuration of data media or of the equipment or programmes used for recording may cause some titles (tracks) or data media to be unreadable. On the Internet, for example, you can find information regarding the best way to create audio files or data media (compression rate, ID3 tag, etc.).

Complex folder structures can slow down data reading.

**Playlists** only establish a certain playback order. The files are **not** saved in them. Playlists **cannot** be played if the files on the data media are **not** saved to the path to which the playlist refers.

## Playback order of files and folders

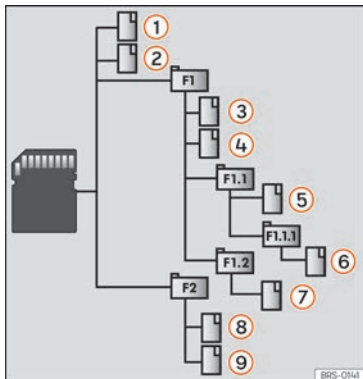

**Fig. 123** Example of the structure of a data media with MP3 files.

The audio files stored on data media are often arranged by file folders and playlists to establish a certain playback order.

Depending on their name on the data media, tracks, folders and playlists are ordered numerically and alphabetically, respectively.

Subfolders are treated as folders and numbered according to the order in which they are found in the data media.

The illustration **Fig. 123** shows an example of a conventional MP3 data media, containing tracks , folders and subfolders .

The tracks and folders of this data media are displayed and played in the following order:

1. Track **1** and **2** in the **root directory (ROOT)** of the data media.
2. Tracks **3** and **4** in the **first F1** folder of the data media root directory (indication: **01**).
3. Track **5** in the **first F1.1** subfolder of folder **F1** (indication: **02**).
4. Track **6** in the **first F1.1.1** subfolder of folder **F1.1** (indication: **03**).
5. Track **7** in the **second F1.2** subfolder of folder **F1** (indication: **04**).
6. Track **8** and **9** in the **second F2** folder (indication: **05**).

Playlists are played in the same order as the folders.

### Note

**The playback sequence can be modified by selecting the playback mode (MIX)**  
 page 125.

## Select a Media source

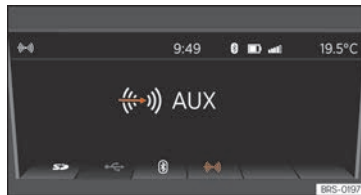

**Fig. 124** Select a Media source





Press the equipment button to switch to the Media mode.

When switching to the Media mode, the bottom of the display shows the available Media sources for a few seconds. The Media source that is currently playing is highlighted.

### Open the Media selection menu manually and select a Media source

- In the Media mode, press the equipment button to display the *Media selection menu* again.
- Enable the Media source you want by pressing the corresponding function button.
- **OR:** Press the equipment button again to cycle through the available Media sources.

## Function button: Media source

	SD card in the slot for SD cards »» page 122.
	USB data storage in the USB socket »» page 123. You can see the location of the connection in »» page 97.
	Smartphone paired through Bluetooth »» page 123
	External audio source connected to the AUX-IN multimedia socket »» page 124.

When a Media source that has already been played is selected again, playback is resumed from the point at which it ended (except for: **AUX** »» page 124).

## SD card playback

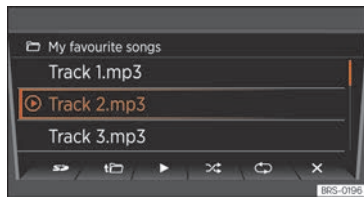





**Fig. 125** SD card playback: List of tracks.

- Insert the SD card first with the cut corner facing up and the title on the left in the slot for SD cards.

- Press the button .

Playback continues with the last Media source selected. To play the SD card press .





In the folder view, browse with the  function button and the settings button. Press  to access a higher folder level and rotate the settings switch to select the desired folder.

To switch to the previous or next track, press either  or .



Hold one of the arrow buttons to fast-forward or rewind the track.

During playback, the following function buttons are available on the bottom of the display. Active function buttons are highlighted.

## Function button: Meaning<sup>a)</sup>

	Playlist notification. Here you can also select a track directly with the settings button »» Fig. 125.
	Previous track or rewind.
	Play. It can also be pressed to stop the playback. In this case, the symbol changes to <b>II</b>
	Next title or fast-forward
	Random play.







## Function button: Meaning<sup>a)</sup>

	To repeat a folder or track. The  symbol indicates that the current track is on repeat.
---	--

<sup>a)</sup> Valid for Media sources: SD card, USB socket and Bluetooth audio

In the list of playlists (button ) the following options are available:

## Function button: Meaning

	To change the main folder of the SD card.
	To access a higher folder level. In the folder list, you can select a different audio source with  »» page 121.
	Play. It can also be pressed to stop the playback.
	Random play.
	To repeat a folder or track. The  symbol indicates that the current track is on repeat.

## Ejecting the SD card

Connected data storage devices must be prepared before their disconnection in order to remove them without damaging it.

- Press the Infotainment button  and then press **System settings**.
- Select **Remove source safely** and then **SD Card**. After correctly ejecting the data

storage device from the system, the function button becomes inactive (grey colour).

- Now you can remove the SD card.

### External data storage device in the USB port

Depending on the country and device, there might be one or several USB ports  in the vehicle.

The location of the USB ports  depends on the vehicle in question.

Audio files on an external data storage device connected to the USB port  can be played and controlled via the Infotainment system.

Where this manual refers to external data storage devices, this means USB mass storage devices containing supported audio files, such as MP3 players, iPods™ and USB sticks.

Only compatible audio files are displayed. Other files are ignored.

The rest of operations to use the external data device storage (changing tracks, selecting tracks and enabling playback modes) are carried out similarly to other audio sources (e.g. "Playback from SD card" **»» page 122**).

### Instructions and restrictions

The number of USB ports  and their compatibility with Apple™ devices as well as with other media players depends on the features.





The USB port  supplies the usual USB voltage of 5 volts for a USB connection.

Due to the large number of different data storage devices and various iPod™ and iPhone™ generations available, it is not possible to guarantee fault-free operation of all functions described here.

Take into account all other instructions and limitations regarding requirements for media sources.

### Disconnecting

Connected data storage devices **must** be prepared before their disconnection in order to remove them.

- Press the Infotainment button  and then press .
- Select  and then . After correctly ejecting the data storage device from the system, the function button becomes inactive (grey colour).
- Now the data storage device can be disconnected.

## Bluetooth® playback\*



### Connection of a safe audio source through Bluetooth

Bluetooth® audio mode allows audio files that are being played on a Bluetooth® audio source (e.g. a mobile phone) connected by Bluetooth® through the vehicle's speakers (Bluetooth® audio playback).

### Requirements

- The Bluetooth® audio source must be compatible with the A2DP Bluetooth® profile.
- In the Bluetooth Settings menu the  must be on.

### Starting Bluetooth® audio transmission

- Switch on Bluetooth® visibility on the external Bluetooth® audio source (e.g. mobile phone).
- Lower the base volume on the Infotainment system.
- Press the button .
- Press the  function button to select Bluetooth® as a media source.
- Start searching for the desired Bluetooth® device.
- Please refer to the instructions on the screen of the infotainment system and on the Bluetooth® audio source regarding the rest of the procedure.

»

You may also need to manually start playback on the Bluetooth® audio source. When playback ends on the Bluetooth® audio source, the infotainment system remains in Bluetooth® mode.

## Controlling playback

The extent to which the Bluetooth® audio source can be controlled via the Infotainment system depends on the Bluetooth® audio source that is connected.

With media players that support the AVRCP Bluetooth® profile, playback on the Bluetooth® audio source can be automatically started or stopped when the unit is switched to Bluetooth® Audio mode or to a different audio source. In addition, it is possible to view or change the track via the Infotainment system.

### WARNING

**Do not perform the pairing and connection process while driving. This may cause an accident!**

### Note

- Due to the large number of possible Bluetooth® audio sources, it is not possible to guarantee fault-free operation of all described functions for all these sources.
- To operate the media and phone with the connected Bluetooth® device, please read

**the manufacturer's electronic Instructions Manual.**

- Only use compatible Bluetooth® devices. You can request information about compatible Bluetooth® products at a SEAT Authorised Service or online.

## External audio source connected to the AUX-IN multimedia socket



The AUX-IN multimedia jack can be found on the front of the radio »» page 109. It can only be used with a 3.5 mm jack connector.

A connected external audio source is played over the vehicle speakers and **cannot** be controlled via the radio system controls.

The AUX-IN multimedia connection must be activated in the system settings so it can be displayed on the *Media selection menu* »» page 121.

### Connecting an external audio source to the AUX-IN multimedia socket

- Lower the base volume on radio.
- Connect the external audio source to the AUX-IN multimedia socket.
- Start playback on the external audio source.

- In the Media mode, press the  equipment button to display the Media source selection menu again »» page 121.
- Press the  function button.

The **output volume** of a connected external audio source should be adjusted to the volume of the other audio sources.

### Adapting the playback volume

If you need to increase the playback volume for the external audio source, first lower the base volume on the radio system.

If the sound from the external audio source is **too low**, increase the **output volume** on the external audio source, if possible. If this is not enough, adjust the **input volume** in the system settings to **Level 2** or **Level 3**.

If the sound from the connected external audio source is **too loud or distorted**, lower the **output volume** on the external audio source, if possible. If this is not enough, change the **input volume** to **Level 2** or **Level 1**.

### Note

- When the playback from the external audio source ends or the connection to the AUX-IN socket is interrupted, the radio goes back to the AUX menu.
- Interference noise may be heard if the external audio source is powered from the 12-volt power socket of the vehicle.

- Please read and observe the manufacturer's instruction manual for the external audio source.

### Track information display

In the case of audio files that contain additional title information (ID3 tag in MP3 files) the different stored title data can be displayed »» Fig. 125.

### Changing the playback mode

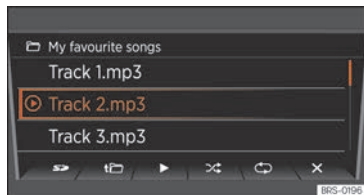

**Fig. 126** SD card playback: Possible playback modes.

Consider the playback order of files and folders »» page 121.

### Selecting playback modes

- Press the function button to start the corresponding playback mode. The function button appears underlined.

⌂ **Random playback:** The tracks are played in random order. Random playback remains active for the corresponding Media source until it is deactivated from that source.

↺ **Repeat:** The tracks of the playlist are repeated.

- Press the function button ⌂ again to end the active playback mode in the track being played.
- Press the function button ↺ again to only repeat the track being played. After pressing once more, the repeat function is deactivated.

## Telephone

### Connection and operation

**Requirements for phone management:** Your mobile phone s connected to the Infotainment System through Bluetooth®.

### Connection between the mobile phone and the Infotainment System

- Please observe the information on the page 123, **Bluetooth® playback\***.
- Press the button **PHONE**.
- On the Bluetooth® menu of your mobile phone, search for the name shown on the display.
- If necessary, take into account the »» page 123 notifications.
- To complete the pairing process, respond to the requests of both devices.

### Changing the volume

Media and phone call playback from a connected mobile phone will be conducted through the speaker of the vehicle.

If voice control is enabled on the mobile phone connected, voice communication will also take place through the vehicle speaker.

The playback volume can be modified with the volume control **Q**.

Moreover, the volume of navigation announcements can be adjusted in the **Sound settings** menu.

If the volume of the system is muted (notification: **⌂**), media sources that are playing on the connected Smartphone are also interrupted. »»

**WARNING**

General, mandatory, legal and country-specific instructions and laws for the use of mobile phones inside the vehicle must always be considered.

**Note**

- To operate the media and phone with your mobile phone plugged in, please read the electronic Instructions Manual of the manufacturer.
- Only use compatible Bluetooth® devices. You can request information about compatible Bluetooth® products at a SEAT Authorised Service or online.

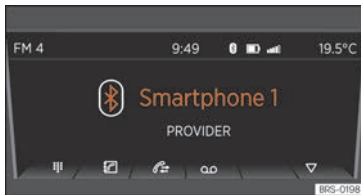
**Functions of the phone**

**Fig. 127** Phone disconnected.

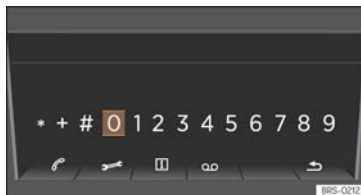

**Fig. 128** Dial a number with the menu button.

After correctly connecting the phone, you can manage the call functions of your paired mobile phone through the Infotainment System »» Fig. 127.

**Dial number:**

Press the »» Fig. 127 function button to display the dial screen »» Fig. 128. Here you can choose a number with the right switch and confirm it by pressing. If the number is correct, the call can be started through the speaker »» Fig. 128.

Moreover, the following options are available here:

- : calls the emergency number<sup>1)</sup>.
- : connects to a SEAT fault service<sup>1)</sup>.
- : connects to the SEAT information hotline<sup>1)</sup>.

- : starts call to your voice mail. For this purpose, your mailbox number will be requested the first time you select it.

**Phonebook:**

Press the »» Fig. 127 function button to display the phonebook. The phonebook contains all the contacts of your mobile phone, which you can select one by one with the right switch and establish a connection by pressing it, or either access a list with available numbers first. For this purpose, during the first connection, you have to confirm the transfer of your mobile phone contacts. With the star button you can save a contact as a fast-dial number.

**Call log:**

Press the »» Fig. 127 function button to display call log. All the calls from your mobile phone will be shown here once you have confirmed the transfer of your contacts from your phone.

- **ALL**: shows all calls in chronological order.
- : only shows missed calls.
- : only shows received calls.
- : only shows outgoing calls.

The function button bookmarks an entry.

<sup>1)</sup> Not available in all countries.



## Voice mail:

Press the **QO** >>> **Fig. 127** function button to access your voice mail inbox. For this purpose, your mailbox number will be requested the first time you select it.

## Emergency call:<sup>1)</sup>

Press the **SOB** >>> **Fig. 127** function button to make an emergency call.

## Favourites

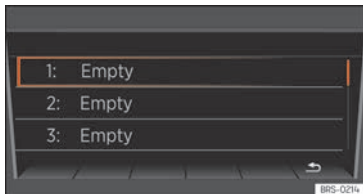

**Fig. 129** Fast-dial

## Fast-dial:

Press the **▽** >>> **Fig. 127** function button to open the fast-dial list >>> **Fig. 129**. Select an empty slot of your fast-dial list to access the phonebook, where you can choose a contact as a fast-dial number. Select a used slot to dial its corresponding phone number.

<sup>1)</sup> Not available in all countries.

## Call by telephone

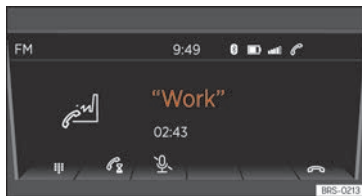

**Fig. 130** Ongoing call.

## Incoming call:

If you receive a call, you have three options:

- accepting the call with the **☎** function button.
- muting the ringtone with the **🔇** function button.
- rejecting the call with the **📞** function button.

## Active call:

If you accept the incoming call, you have the following options during the call >>> **Fig. 130**:

- Press the **📞** function button to emit DTMF tones (e.g. to operate an answering machine).

- Press the **⏸** function button to pause the phone call.
- Press the **🔇** function button to mute the microphone.
- Press **📞** to end the call.

## Settings of a connected phone

Use the **MENU** equipment button to access the phone's settings: The following options are available:

**Hands-free:** If there is an ongoing call, you can continue the call on the mobile phone or transfer it back to the Infotainment System.

**Phone selection:** Cycle through the phones recognised by the Infotainment System or search for new devices.

**User profile:** Change the settings of the phone currently connected:

Manage your fast-dial numbers (e.g. delete one).

Set or change voice mail numbers.

Sort your phonebook.

Download your contacts again.

Activate/deactivate mobile phone notifications when turning off the engine. **>>**

Select a ringtone (only if the phone is not emitting any sounds).

**Bluetooth®:** Here you can change the connection settings of the telephone. For instance, you can delete known devices.

#### Note

- If a device connected by Bluetooth® supports this profile, it will always be used at the same time for calls and audio through Bluetooth®.
- To operate the media and phone with your mobile phone plugged in, please read the electronic Instructions Manual of the manufacturer.

## Drive Mii App\*

### Introduction



Fig. 131 Application connection main menu.

The connected smartphone offers the following options:

- 1) Navigation over the smartphone with navigation announcements on the radio.
- 2) ECOTRAINER display.
- 3) Driving data notifications.
- 4) Notifications from the odometer, etc.
- 5) Search in all fields.

You can also use the telephone function of your connected smartphone over the radio using the right switch.

#### Note

To operate the telephone and multimedia aspects and for navigation with the connected smartphone, read the instructions manual of the manufacturer.

### Connection and operation

**Requirement:** Your smartphone is connected to the radio through USB » page 123 and the SEAT application to connect the smartphone to the radio is installed on your smartphone<sup>1)</sup>.

Place the smartphone in its socket and turn it on. Removal and installation of the equipment and the socket are described in » page 98.

#### Connection between smartphone and radio

- Press the button **MENU** to open the main menu.
- Afterwards, select and enable the **Connection of the application** function with the settings button.

Once the connection is established, you can manage radio music playback with the

<sup>1)</sup> For more information about the application regarding installation and use, take into account the information provided with the vehicle.

smartphone. You can start the navigation on the smartphone and listen to the navigation announcements on the audio system of the vehicle.

### Instructions for navigation

Acoustic navigation announcements will be played on the speakers of the vehicle. Regarding this, take into account the instructions in **Adjusting the volume** »» page 129.

You can manage this from the connected smartphone »» page 129.

### Changing the volume

Multimedia playback, navigation announcements and phone calls emitted by the connected smartphone will be played on the speakers of the vehicle.

The volume of the traffic announcement can be modified with the volume control .

You can also adjust the volume of the navigation announcements on the **Sound settings** menu.

When the volume of the system is muted (notification: ) , playback of multimedia sources played on the connected smartphone is also interrupted.

#### Note

- For more information about the installation and use of the application, see the information provided with the vehicle.
- To operate the media and phone and to navigate with your Smartphone plugged in, please read the electronic **Instructions Manual of the manufacturer**.
- If a device connected by Bluetooth® supports this profile, it will always be used at the same time for calls Bluetooth® audio and the connection for apps.
- Only use compatible Bluetooth® devices. You can request information about compatible Bluetooth® products at a SEAT Authorised Service or online.

## Connectivity

## Cybersecurity

### Introduction

Control units with integrated eSIM card, interfaces and connections for multimedia and diagnosis are connectivity components through which data and information can be exchanged between the vehicle and external devices or the Internet »» . The connectivity components mainly include the following:

- Connection socket for diagnosis
- Control units with integrated eSIM card
- Telephone interface
- Media Control
- App-Connect
- WLAN access point (hotspot)
- Bluetooth connection
- USB connection
- AUX-IN multimedia socket
- Slot for SD cards
- Slot for SIM cards

The connectivity components are key points in cybersecurity. The connectivity components in particular, but also other control units, are fitted with locking mechanisms that »

minimise the risk of unauthorised third parties accessing the vehicle's systems.

Software and locking mechanisms mounted on the vehicle are being developed continuously. As in the case of computers or mobile phone device operating systems, software and locking mechanisms mounted on the vehicle can also be updated non-periodically.

In general, software updates improve the security, stability and speed of execution of vehicle systems that have already been manufactured.

You can actively contribute to reducing the risk of unauthorized third parties accessing the vehicle systems and their functions:

- Do not use data storage devices, Bluetooth devices or mobile phone devices that contain manipulated data or malicious software in the vehicle.
- Only get vehicle repair and maintenance work done at specialised workshops. SEAT recommends visiting a SEAT dealership for this.

### WARNING

**Computers, data storage devices and mobile phone devices that connect to the Internet or that are used on public or private networks can be infected by manipulated data and malicious software.**

- **In addition to taking the generally known precautionary measures when using the Internet, you should protect your computer, your data storage devices and your mobile phone with an appropriate antivirus program and regularly update your login details.**

### WARNING

**The risk of unauthorized third parties accessing the vehicle's functions and control units through malicious software or an Internet attack cannot be ruled out despite the locking mechanisms fitted to the vehicle. If malicious software is introduced into the vehicle, it can influence, deactivate or control the control units and vehicle functions and cause serious accidents and fatal injuries.**

- **Malicious software can also access data and information stored in control units, the infotainment system, connected data storage devices and paired mobile phone devices.**
- **If the vehicle operates differently than usual or reacts or behaves strangely, reduce the speed immediately (whenever possible) in a controlled manner and go to the nearest specialized workshop without delay or request the help of specialized personnel, e.g. to tow the vehicle.**

## SEAT CONNECT

### Introduction

SEAT CONNECT groups together different SEAT CONNECT service portfolios that offer additional functions for your vehicle, e.g. Remote Access. These services can be executed, for example, from home with a computer or away from home with a mobile phone device (smartphone or tablet).

The vehicle and the computer or mobile phone are connected to each other by an Internet connection.

SEAT CONNECT is equipment that is not available in all countries, which is made up of several portfolios. It has to be activated online before it can be used and it is subject to country-dependent time use limitation.

Both the SEAT CONNECT service portfolios offered by SEAT and individual services can be modified, cancelled, deactivated, reactivated, renamed and extended, even without prior notification.

On the website <https://my.seat> you can create a user account, consult descriptions of SEAT CONNECT services and find out more about them.

The availability of SEAT CONNECT services can vary depending on the model and equipment.

## Activating SEAT CONNECT

SEAT CONNECT can be activated at <https://my.seat> or, in some vehicles, directly in the infotainment system:

- First step: create a user account.
- Second step: add your vehicle to the user account.
- Third step: activate SEAT CONNECT.

## Description of services

Before running SEAT CONNECT services, read and take into account the corresponding services description. Descriptions are updated non-periodically and are available online. Always use the most up-to-date version of the corresponding service description.

The initial service allocation shown here corresponds to the first generation of SEAT CONNECT fitted to the Mii electric:

- Vehicle status incl. doors and lights
- Driving data
- Parking position
- Remote air conditioning
- Electrical power manager
- Departure times

### **WARNING**

In areas with insufficient mobile phone and GPS coverage, neither emergency calls or

phone calls can be made, and data cannot be transmitted.

- Change location if possible.

### **CAUTION**

The vehicle may be damaged by factors outside SEAT's control. These may be specifically:

- Insufficient network coverage
- Misuse of mobile terminals
- Data loss during transmission
- Unsuitable or defective third party applications
- Malicious software on data storage devices, computers, tablets or mobile phones

## Legal provisions

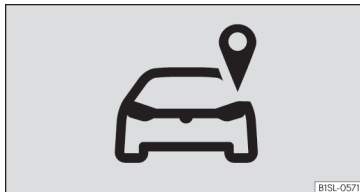

**Fig. 132** Marking for vehicles that send tracking information.

When contracting SEAT CONNECTION services for your vehicle, you are obliged as a contractor, for the purposes of the data protection law, to inform any driver of the vehicle that it can transmit or receive data online. This also applies if the vehicle is sold or lent.



Not taking into account this obligation to inform, can infringe certain rights of the occupants.

### GPS tracking: consult all occupants

Some SEAT CONNECT services need vehicle data to determine at any given time whether the vehicle is being used or moving within defined speed ranges, where it has been parked or if it is being used in an established geographical area. This information is displayed in the MySEAT web portal and in the SEAT CONNECT app.

Therefore, before moving off, ask all the vehicle occupants if they agree with the activated services. If they do not, deactivate the service in question (if possible) or do not allow the occupants to use the vehicle. If you do not take this into account, you may infringe upon certain rights of the occupants.

### GPS tracking: marking

If the vehicle has a factory assembled control unit that transmits its current geographical position and speed, the vehicle usually has this marking    **Fig. 132** (e.g., on the

»

roof console). The absence of this marking »» Fig. 132 in the vehicle does not guarantee that the control unit does not transmit the vehicle's current geographical position and speed.

### Personal data

SEAT collects, processes and uses the user's personal data within the framework of the law. On the SEAT website you can consult the current data confidentiality statement.

### Deactivating SEAT CONNECT services



**Fig. 133** Sticker subsequently affixed to the vehicle that indicates that the SEAT CONNECT services have been permanently disconnected.

To permanently deactivate the SEAT CONNECT functionality, go to a specialized workshop and request the deactivation of the

control unit called "Emergency call module control unit and communication unit".

Once the "Emergency call module control unit and communication unit" has been deactivated, the workshop in question generally affixes the sticker »» Fig. 133 to the vehicle, e.g. to the roof console. The sticker indicates that "Remote Access" services do not work.

If you sell the vehicle or lend it for a long period of time, warn the buyer or the user that the services and the control unit are deactivated.

### Faults

Even if the prerequisites for the use of SEAT CONNECT services are met, there may be factors beyond the control of SEAT that interfere with the execution of such services or prevent them. These may be specifically:

- Maintenance, repair, deactivation, software update and technical expansion of telecommunication equipment, satellites, servers and data banks.
- Change of the mobile telephony standard for the transmission of mobile data by the telecommunications service provider, for example, from UMTS to EDGE or GPRS.
- Disconnection of an existing mobile phone standard by the telecommunications service provider.

- Interference, disturbance or interruption in the reception of the mobile phone and GPS signal due to aspects such as high-speed driving, solar storms, meteorological influences, topography, blocking equipment and the intensive use of mobile phones in the radio cells in question.

- When in areas with zero or insufficient mobile telephony or GPS coverage. Also, for example, in tunnels, confined areas between very tall buildings, garages, underpasses, mountains and valleys.

- External information from third party supplies available with limitations, incomplete or incorrect, e.g. representations of maps.

- Countries and regions where SEAT CONNECT is not offered.

# Driving

## Drive system and driving

### Driving indications

#### Electric drive system functions.

##### Delivery of power from the electric engine

The maximum torque of the electric engine is available immediately after pressing the accelerator pedal.

##### Brake energy recuperation (charging)

When braking the vehicle, electric power is generated through the electric engine and stored in the high-voltage battery

»» page 134. This also occurs to a lesser extent when the vehicle moves by inertia or drives downhill in the deceleration phase.

As the charge level of the high-voltage battery increases, the recuperation reduces and, thus, the effect of the engine brake. When the high-voltage battery is fully charged, no energy recuperation takes place and the effect of the engine brake is not available »» ⚠.

The energy recuperation can be displayed on the instrument panel display or in the application installed on the smartphone.

##### Slow travel function

The slow travel function consists of driving slowly, at about 5 km/h (3 mph), forward or reverse without pressing the accelerator pedal.

The slow travel function is activated automatically:

- When the drive system is connected and the selector lever is placed in the **D/B** position or the reverse gear is engaged **R**.
- Each time the selector lever is changed to position **D/B** or **R**.
- When the vehicle is travelling less than 10 km/h (6 mph) and the driver's door is opened.
- When the vehicle is stopped and the brake pedal is pressed, the driver's door opens or the driver unbuckles the seat belt.

The slow travel function is deactivated if, when the driver's door is closed and the seat belt is in place:

- The vehicle is travelling at more than 10 km/h (6 mph).
- The selector lever is in position **P** or **N**.
- If, after connecting the drive system, the vehicle was once in motion.

- When the drive system is connected and the selector lever is in the **D/B** position or reverse gear is engaged, the vehicle must be stopped by pressing the brake pedal. Even when the drive system is switched off, it is possible that the power transmission is not interrupted completely and the vehicle continues to "move slowly".

- Never leave the vehicle with the selector lever in the **N** or **D/B** position. The vehicle will roll downhill regardless of whether the drive system is connected or not.

#### ⚠ WARNING

As the level of charge of the high-voltage battery increases, the effect of the engine brake caused by the recuperation of the brake energy is reduced and may even be completely cancelled out.

- Slow down before starting a long distance with a steep descent.
- During a long distance with a steep descent, reduce the speed with the vehicle brake.

#### ⚠ WARNING

Any accidental movement of the vehicle could result in serious injury.

## Brake energy recuperation

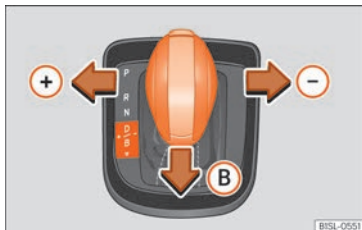

**Fig. 134** On the selector lever: connect the brake energy recuperation.

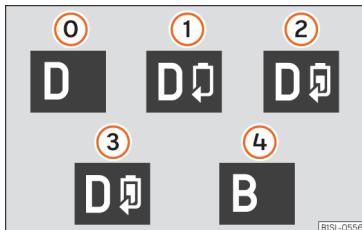

**Fig. 135** On the instrument panel display: indication of recuperation levels.

The brake energy recuperation can generate a braking effect. This braking effect depends on the selected driving programme and the level of charge of the high-voltage battery.

When braking the vehicle and when the vehicle moves by inertia or travels downhill in the deceleration phase, electric power is generated by the electric engine and stored in the high-voltage battery. The electric engine then operates as an alternator and produces an engine brake effect. This process is called brake energy recuperation.

The status of the recuperation is indicated in the power display of the instrument panel »» page 57. When recuperation is active, the needle goes to the green area of the display. The current recuperation level is displayed on the instrument panel display »» Fig. 135.

Given the case, in the application installed on the smartphone you can view a statistic of the energy recuperated over the last 30 minutes. Check the electronic instruction manual of the application for this.

The effect of the engine brake is more or less intense depending on the level of recuperation. If the recuperation is very intense, the brake light of the vehicle may also be switched on. As the charge level of the high-voltage battery increases, the recuperation reduces and, thus, the effect of the engine brake.

When the high-voltage battery is fully charged, no energy recuperation takes place and the effect of the engine brake is not available. When the vehicle detects that road conditions do not allow safe contact between the wheels and the road, the energy recupera-

tion is automatically reduced and, therefore, the effect of the engine brake »»

### Select a recuperation level

There are a total of 4 brake energy recuperation levels. You can switch between recuperation levels 1 to 3 by pressing the selector lever slightly sideways towards »» Fig. 134 and :

- Push the selector lever slightly to the **left** to increase one recuperation level.
- Push the selector lever slightly to the **right** to decrease one recuperation level.
- Push the selector lever to the **right** for a few seconds to disconnect the recuperation.

To increase to recuperation level 4, push the selector lever slightly to position **B**. Pushing it again gently in the direction of the arrow , it is changed back to position **D** and the last recuperation level that was selected is activated.

### Recuperation level »» Fig. 135 and meaning:

D	The vehicle moves by inertia. Recuperation only takes place when braking.
D	Slight recuperation, recuperation level 1
D	Medium recuperation, recuperation level 2



### Recuperation level »» Fig. 135 and meaning:

3 D	Intense recuperation, recuperation level 3
4 B	Very intense recuperation, recuperation level 4

#### ⚠ WARNING

A medium, intense or very intense recuperation of brake energy can cause loss of traction and the vehicle skidding, especially on slippery roads. This could cause loss of control of the vehicle, accidents and serious injury.

- Never use a medium, intense or very intense brake energy recuperation if the conditions of visibility, weather, road and traffic do not allow it, or if it endangers other users on the road due to the acceleration of the vehicle and the driving style.

#### ⚠ WARNING

As the charge level of the high-voltage battery increases, the effect of the engine brake caused by the recuperation of the brake energy is reduced and may even be completely cancelled out. This puts much greater demand on the vehicle's brakes.

- When charging the high-voltage battery in high-altitude locations (e.g. on top of a mountain pass), never fully charge it. In this way, when descending the mountain the

engine braking effect through recuperation will be enabled.

- Slow down before starting a long distance with a steep descent.
- During a long distance with a steep descent, reduce the speed with the vehicle brake.

## Connecting and disconnecting the drive system

### Control lamps

#### EPC It lights up yellow

Failure in engine management.  
Go immediately to a specialised workshop and request the electric drive system be checked.

Several warning and control lamps light up for a few seconds when the ignition is switched on, signalling that the function is being verified. They will switch off after a few seconds.

#### ⚠ WARNING

Observe the safety warnings »» ⚠ in Control and warning lamps on page 66.

### Ignition lock

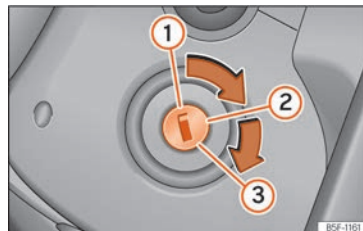



Fig. 136 Ignition key positions.

When there is no vehicle key in the ignition lock, the steering column lock may be activated.

Positions of the vehicle key »» Fig. 136

- 1 Ignition off. The key can be removed.
- 2 Ignition is switched on. The steering lock may be released.
- 3 Press the brake pedal if the control lamp  lights up green. Connection of the drive system. When the drive system is connected, release the key. When it is released, the key returns to position »» Fig. 136 2.

#### Warning that the ignition is connected

When the ignition is connected and the driver's door is open, the warning message **IGNITION ON** may light on the instrument panel »

display. Additionally, a warning acoustic signal may sound.

The purpose of the warning is to remember to switch off the ignition before leaving the vehicle.

### WARNING

If the vehicle keys are used negligently or without proper attention, accidents and serious injuries can occur.

- Never leave any key inside the vehicle when exiting. The key can connect the drive system and certain electrical equipment can be operated, such as electric windows, which can cause serious injuries.
- When locking the vehicle, never leave any child or anyone who may need help inside. They could be trapped in the car in an emergency and will not be able to get themselves to safety. Thus, for example, depending on the season, a closed vehicle can reach very high or very low temperatures that can cause serious injuries and illnesses or even death, especially in the case of young children.
- Never remove the key from the ignition lock when the vehicle is moving. The steering column lock could suddenly become locked and it would be impossible to steer the vehicle.
- The bit of the vehicle key must be completely unfolded and locked.

- Do not fix objects that exceed 100 g in total to the vehicle key.

### Note

- If the vehicle key remains for a long time in position ② of the ignition lock with the electric drive system disconnected, the 12-volt battery will discharge.
- The key can only be removed from the ignition lock if the selector lever is in position P. If necessary, press the lock key on the selector lever and release it again.
- The key can only be removed from the ignition lock if the selector lever is in position P. If necessary, press the lock key on the selector lever and release it again.

### Connecting the drive system

When the electric drive system is connected, the electric engine is connected and the vehicle is ready to move.



#### Requirements for connecting the drive system

The drive system can be connected when the following conditions are met:

- The level of charge of the high-voltage battery is sufficient.
- There is no charging cable plugged in.

- The temperature of the high-voltage battery is within the operating range.

### Connecting the drive system

- Connect the ignition  page 135.
- Press the brake pedal and keep it pressed. If the brake pedal is not pressed, the control lamp comes on  in green and the instrument panel displays the message **The brake pedal is not pressed**.
- Set the selector lever to the **N** position or engage the parking lock.
- Keep turning the key in the ignition lock without stepping on the accelerator. Keep the key in this position until the control lamp **READY** comes on. When the control lamp **READY** comes on in the instrument panel display, release the key. The needle of the power indicator goes from **Off** to **0**.
- If the control lamp **READY** does not turn on, interrupt the process and repeat it.
- When you start to move, release the handbrake.

### Noises before starting to move

When you connect the drive system you may hear a “click”. This is quite normal, and no cause for concern.

### Indication that the drive system is connected

The electric engine does not generate noticeable noises neither when connecting the drive system nor when it is running. Therefore, it is not possible to recognise whether the drive system is running based on the engine noises. Instead, you can recognise that the drive system is connected by the following characteristics:

- The needle of the power display located on the instrument panel is position in **0** » page 57.
- The lighting of the needles of the instrument panel is on, regardless of whether the exterior lighting of the vehicle is on.
- The indicator lamp on the instrument cluster switches on **READY**.
- An acoustic signal sounds.

### Connecting and disconnecting the drive system at very low outside temperatures

If the outside temperature is very low (approximately -27 °C [-16 °F] and lower), the high-voltage battery may freeze and not work. Then it is not possible to connect the drive system.

Once the temperature of the high-voltage battery has risen sufficiently, the drive system can be reconnected.

To ensure that the drive system can be connected at very low outside temperatures, SEAT recommends leaving the vehicle parked in a place that is protected from weather conditions.

### Starting to move with the electric drive system

- Connect the drive system. When doing so, press the brake pedal and keep it pressed.
- Set the selector lever to the **D/B** position or engage the reverse gear » page 140.
- Release the handbrake and brake pedal » page 152.
- Press the accelerator pedal.

#### WARNING

Never leave the vehicle with the drive system connected. The vehicle could suddenly start moving or something unusual could happen that could cause damage, fire or serious injury.

- Always switch off the ignition before leaving the vehicle.
- When leaving the vehicle parked or getting out of it, always check that the selector lever is in the **P** position and that the handbrake is applied and tightened.
- When leaving the vehicle, always make sure that all the doors, the windows, the rear lid and the bonnet are completely closed and locked.

#### Note

If the outside temperature is very low and, therefore, the high-voltage battery is very cold, the electrical driving and autonomy may be limited.

### Disconnecting the drive system

Perform the following operations only in the order indicated:

- Stop the vehicle.
- Park the vehicle » page 154
- Switch the ignition off.
- Bear in mind the indications on the instrument panel » page 57.

#### WARNING

Never leave the vehicle with the drive system connected. The vehicle could suddenly start moving or something unusual could happen that could cause damage, fire or serious injury.

- Always switch off the ignition before leaving the vehicle.
- When leaving the vehicle parked or getting out of it, always check that the selector lever is in the **P** position and that the handbrake is applied and tightened.
- When leaving the vehicle, always make sure that all the doors, the windows, the

»

rear lid and the bonnet are completely closed and locked.

### WARNING

Never disconnect the drive system when the vehicle is in motion. This could cause loss of control of the vehicle, accidents and serious injury.

- Airbags and belt tensioners do not work.
- The brake servo does not work when the electric drive system is disconnected. To stop the vehicle, the brake pedal must be pressed harder.
- The power steering does not work with the electric drive system disconnected and more strength is needed to turn the steering wheel.
- If the key is removed from the ignition lock, the steering lock could block and it would not be possible to control the vehicle.

### WARNING

The components of the high-voltage system become extremely hot and could cause fire and serious injury.

- Never park the vehicle in a manner that any component of the high-voltage system comes in contact with highly flammable materials that may be found under the vehicle, e.g. brush, litter, dry grass, etc.

- Never use additional protection for vehicle underside of the vehicle or anti-corrosive products for thermal insulation elements.

### Note

- The key can only be removed from the ignition lock with the selector lever in position P.
- After disconnecting the electric drive system it is possible that the radiator fan continues to work in the engine compartment for a few more minutes, even with the ignition switched off or the key outside the ignition lock. The radiator fan is automatically switched off.

## Never leave the vehicle with the drive system connected

If, after stopping the vehicle, the driver leaves the vehicle with the drive system switched on, the system switches off automatically.

This protects the vehicle against unauthorised use.

### Warning when leaving the vehicle

When the driver's door is opened or the seat belt is unbuckled, a warning signal sounds and the message **The vehicle may still move** will appear on the instrument panel dis-

play. This is intended to remind the driver to disconnect the ignition before leaving the vehicle.

### Automatic disconnection of the drive system.

In certain situations, the drive system of the vehicle is automatically switched off. In addition, a warning message may appear in the instrument panel. The drive system will switch off when the following conditions are met:

- The vehicle is stopped.
- The selector lever is in **D/B** position.
- The slow travel function is not active.
- The driver unbuckles his seat belt, opens the door and removes his foot from the brake pedal.

### Automatic connection of the drive system

The drive system may automatically reconnect within 30 seconds. To do this, the driver's door must be closed and the seat belt must be buckled, as well as meeting one of the following conditions:

- The handbrake is on or the selector lever is in position **P**.
- **Or**, the brake pedal is pressed if the vehicle is moving.

A short sequence of acoustic signals indicates that the drive system has been reconnected.

If 30 seconds elapse without the drive system being reconnected, the drive system can be reconnected manually as described in **»» page 136**. In this case, bear in mind the messages shown on the instrument panel display.

### **WARNING**

**If the vehicle is left unattended with the drive system connected, accidents and serious injuries can occur.**

- Never leave the vehicle unattended with the drive system connected.
- Always switch off the ignition and place the selector lever in position P before leaving the vehicle.
- When parking or getting out of the vehicle, always check that the selector lever is in the P position and that the handbrake is applied and tightened.
- When leaving the vehicle, always make sure that all the doors, the windows, the rear lid and the bonnet are completely closed and locked.

### **Electronic immobilizer**

The electronic immobiliser helps to prevent the drive system from being connected with

an unauthorised key and, consequently, the vehicle being put in motion.

The vehicle key has a built-in chip. When a valid key is inserted into the ignition lock, the chip automatically deactivates the electronic immobiliser.

The electronic immobiliser will be activated again automatically as soon as you pull the key out of the ignition lock.

For this reason, the vehicle's drive system can only be connected with a properly coded Original SEAT key. This type of keys can be purchased from a SEAT dealer.

### **Note**

**The correct operation of the vehicle is only guaranteed with the original SEAT keys.**

## **Problems and solutions**

### **Cannot remove the vehicle key from the ignition lock**

An unauthorised key has been inserted into the ignition lock.

To remove the key, proceed as follows:

- Press the lock key on the selector lever and release it again.
- Remove the key from the ignition switch.

### **The drive system cannot be connected**

If an unauthorised vehicle key is used or there is a fault in the system, an indication appears on the instrument panel display.

- Use an authorised key.
- If the fault continues, seek specialist assistance.

### **The vehicle has stopped because the high-voltage battery has discharged**

The relevant text message will appear in the instrument panel display.

If the vehicle has stopped because the high-voltage battery has discharged, there is the possibility of reconnecting the electric drive system to travel a few meters and be able to remove the vehicle from the flow of traffic or from a level crossing, etc.

- Switch the ignition off.
- Reconnect the drive system.
- Press the accelerator pedal to start moving.

This process can be repeated a second time, although the distance that can be travelled and the power is reduced considerably.

If the vehicle can no longer move, seek the assistance of specialised personnel.

Charge the high-voltage battery  
**»» page 160**.

## Gear selection

### Control lamps



It lights up red

#### There is a fault in the electrical system.

The instrument panel display shows the message

**Error: Electr. Syst. Stop the vehicle!**

⚠️ **Stop the vehicle immediately** as soon as it is possible and safe, park it outdoors and disconnect the drive system. Seek specialist assistance.



and They light up red

#### The electrical system has overheated.

The instrument panel display shows the message

**Electr. system overheated. Stop! Manual!**

⚠️ **Stop the vehicle immediately** as soon as it is possible and safe, park it outdoors and disconnect the drive system. **Do not pour coolant!** Seek specialist assistance.



and They light up yellow

#### Brake energy recuperation is not possible.

The instrument panel display shows the message

**Error: Recuperation. Check the manual.**

There is a failure in the brake energy recuperation. Autonomy may be limited. Contact a specialised workshop.



They light up yellow

#### Limited braking capacity.

The instrument panel display shows the message

**Error: Limited braking capacity.**

The braking system does not work or has a fault. Contact a specialised workshop.



It lights up green

#### The engine will not start.

The brake pedal is not pressed when changing the position of the selector lever from **N**. To change the position of the selector lever, press the brake pedal.



Flashes green

#### The lock button prevents starting to move.

The vehicle is prevented from moving forwards. The selector lever locking button is not engaged.

Several warning and control lamps light up for a few seconds when the ignition is switched on, signalling that the function is being verified. They will switch off after a few seconds.

### ⚠️ WARNING

Observe the safety warnings »» ⚠️ in Control and warning lamps on page 66.

### Gear selector lever



Fig. 137 Gear selector lever

The vehicle has a forward gear **D/B** and a reverse gear **R**.

The selector lever has a lock. To change the selector lever from position **P** or **N** to another position, switch on the ignition, press the brake pedal and press the lock button on the lever button in the direction of the arrow »» Fig. 137.

#### P – Parking lock

The drive wheels are locked mechanically. Select this position only when the vehicle is stopped.

#### R – Reverse gear

The reverse gear is engaged. Select this position only when the vehicle is stopped.

**N - Neutral**

The electric drive system is in the neutral position. No movement is transmitted to the wheels and the braking effect of the electric engine does not occur.

**D – Permanent forward drive position**

The electric drive system is in the normal programme (brake energy recuperation levels 0-3).

**B – Very intense brake energy recuperation**

Very intense brake energy recuperation is deceleration phases (brake energy recuperation level 4).

**▽ – Change between D and B**

Changed between **D** and **B** by pushing the selector lever gently backwards from position **D/B** » **Fig. 137**. The selector lever always returns to **D/B** position. Pushing it gently back again, it changes back to **D**.

**Selector lever lock**

In positions **P** and **N**, the selector lever lock prevents the position selector lever from being changed by mistake and, as a consequence, stops the vehicle from moving without being desired.

To release the selector lever lock, press the brake pedal and keep it pressed with the igni-

tion switched on. At the same time, press the lock button on the selector lever.

If the selector lever is quickly changed from position moving past **N** (i.e. from reverse gear to **D/B**), the lever does not lock. This allows a stuck vehicle to be "towed", for example. If the selector lever remains for more than approx. 1 second in position **N** without having the brake pedal pressed or travelling at a speed below about 5 km/h (3 mph), the lever locks.

In rare cases it may happen that the selector lever lock does not engage. In this case, the traction is cancelled to prevent the vehicle from moving accidentally. To engage the selector lever lock, proceed as follows:

- Press the brake pedal and release it again.
- **OR:** place the lever in the **P** or **N** position and then select a gear.

**⚠ WARNING**

**If the selector lever is placed in an inappropriate position, vehicle control could be lost and an accident and serious injury could result.**

- **Never accelerate when changing the position lever.**
- **Never engage reverse gear or parking lock while the vehicle is in motion.**

**⚠ WARNING**

**Any accidental movement of the vehicle could result in serious injury.**

- **As a driver, never leave your seat when the drive system is connected and a gear is engaged. If you have to leave the vehicle with the electric drive system connected, always engage the handbrake and always place the selector lever in position P.**
- **Never leave the vehicle with the selector lever in the N, R or D/B positions. The vehicle could be set in motion depending on the inclination of the road.**
- **When the drive system is connected and the selector lever is D/B or R position, the vehicle must be stopped by pressing the brake pedal.**
- **Never engage reverse gear while the vehicle is in motion.**

**ⓘ CAUTION**

- **If the vehicle is stopped but the handbrake is not engaged and the brake pedal is released with the selector lever in position P, the vehicle can move a few centimetres forward or backward.**
- **Never allow the vehicle to move with the lever in the N position, especially when the drive system is disconnected.**

»

**Note**

If the selector lever is left for a long time in a position other than P with the ignition off, the 12-volt battery may discharge.

**Driving with an automatic gearbox****Driving down slopes**

The steeper the slope, the higher the selected brake energy recuperation level will have to be. A high recuperation level increases the braking effect of the electric engine. Never let the vehicle roll downhill with the selector lever in the neutral position **N**.

- You should reduce speed accordingly.
- Set the selector lever to the **B** position.

**Stop and start moving uphill**

When the vehicle stops uphill with the forward gear engaged, this will have to be avoided whenever you go backwards by pressing the brake pedal or engaging the handbrake. Do not release the brake pedal or handbrake until you start moving.

**Kick-down**

The kick-down function enables maximum acceleration by pressing the accelerator pedal fully with the selector lever in the **D/B** position. In the **Eco** and **Eco+** driving profiles,

the limitation of the maximum possible speed is cancelled when the kick-down function is used.

**The vehicle does not move even though a gear range is selected**

If the vehicle does not move in the desired direction, the system may not have recognised the gear range correctly.

- Press the brake pedal and select it again.
- If the vehicle still does not move in the desired direction, there is a fault in the system. Request the help of specialised personnel and have the system checked.

**WARNING**

Rapid acceleration can cause loss of traction and the vehicle skidding, especially on slippery roads. This could cause loss of control of the vehicle, accidents and serious injury.

- Never press down hard or suddenly on the accelerator pedal (kick-down) if the conditions of visibility, weather, road and traffic do not allow it, or if it endangers other users on the road due to the acceleration of the vehicle and the driving style.
- Always adapt the driving style to traffic conditions.
- When the ASR is disconnected, the drive wheels may skid, especially if the road is wet, slippery or dirty. This can cause the

vehicle to be neither steered nor controlled.

**WARNING**

Never move the selector lever from position P if the handbrake is not engaged. Otherwise, if the vehicle is on a slope, it could start moving unexpectedly and cause an accident and serious injuries.

**CAUTION**

- When stopping uphill with a selected gear range, do not step on the accelerator to prevent the vehicle from moving backward. Press the brake pedal to avoid unnecessarily overloading the electric drive system.
- If the vehicle moves with the ignition and electric drive system disconnected or with the 12-volt battery discharged or without a 12-volt battery and the selector lever in the N position for a prolonged period of time or at a high speed, the electric drive system will suffer damages.



## Hill driving assistant

### How it works

The hill start assistant helps start moving uphill while keeping the vehicle actively stopped.

**The hill start assistant is automatically connected if the following conditions are met simultaneously:**

- The vehicle is **stopped** facing a hill by stepping on the brake pedal until the vehicle starts moving.
- The engine rotates correctly.
- The gear range **D** is selected or the reverse gear is engaged.

To start moving, remove your foot from the brake pedal and accelerate immediately.

**When starting to moving, the brake is released progressively.**

**The hill start assistant is immediately disconnected:**

- If any of the conditions mentioned above ceases to be met.
- If the driver door is opened.
- If the electric drive system is disconnected.
- If there is any failure in the electric drive system.

- The selector lever is in **N** position.

### ⚠ WARNING

- **If the vehicle does not start moving immediately after releasing the brake pedal, it could roll backwards under certain circumstances. In this case, immediately press the brake pedal or engage the handbrake.**
- **If the engine stops, immediately press the brake pedal or engage the handbrake.**
- **If, when driving uphill in heavy traffic, you want to prevent the vehicle from rolling backwards when you start moving, before moving press the brake pedal for a few seconds.**

## Steering

### Information relating to different vehicle processes.

Electro-mechanical power steering assists the driver when steering.

Electro-mechanical power steering adapts *electronically* to the speed of the car, torque and turning angle. The electromechanical steering only work with the drive system connected.

If the power steering does not work properly or does not work at all, you will have to use

much more strength than usual to turn the steering wheel.

### Mechanical locking of the steering

To make it hard to steal the vehicle, always lock the steering system before leaving it.

The steering column is locked by removing the key from the ignition lock with the vehicle stopped. Turn the steering wheel slightly until the steering lock has engaged.

To release the steering lock, turn the steering wheel slightly to reduce the pressure. Insert the key in the ignition lock. Hold the steering wheel in this position and switch on the ignition.

### ⚠ WARNING

**If the power steering does not work, you have to use much more strength to turn the steering wheel and this can hinder the control of the vehicle.**

- **The power steering only works with the drive system connected.**
- **Never allow the vehicle to move when the drive system is disconnected.**
- **Never remove the key from the ignition lock when the vehicle is moving. The steering lock could suddenly become blocked and it would be impossible to steer the vehicle.**



**ⓘ CAUTION**

If the vehicle needs to be towed, leave the ignition on so that the steering wheel is not blocked and the turn signals, the horn and the windscreen wiper work.

**Control lamp****⚠ It lights up red**

**⚠ Stop driving!** The electromechanical steering is faulty. Have the steering checked immediately by a specialised workshop.

**⚠ It lights up yellow**

The operation of the electromechanical steering is limited. Have the steering checked immediately by a specialised workshop. If the warning lamp does not come on again after restarting the engine and driving a short distance, it is **not** necessary to check the steering.

The 12-volt battery was disconnected and reconnected. Drive a short distance at 15-20 km/h (9-12 mph).

Several warning and control lamps light up for a few seconds when the ignition is switched on, signalling that the function is being verified. They will switch off after a few seconds.

**⚠ WARNING**

Observe the safety warnings »» ⚠ in Control and warning lamps on page 66.

**Driving profiles****Introduction**

By means of the driving profiles, the driver can adapt different characteristics of the vehicle systems to the current driving situation and to an economic driving style. Among the systems that can be adapted are, for example, engine management and air conditioning.

The degree of influence of the vehicle configuration on the different driving profiles depends on the vehicle's equipment.

You can change the driving profile both with the vehicle stopped and while in motion »» ⚠. After selecting a driving profile, the vehicle, except the engine, is immediately configured according to the new profile. When traffic permits, briefly remove your foot from the accelerator so that the selected driving profile is also activated for the engine.

**⚠ WARNING**

Adjusting the driving profile while driving can distract attention from traffic and cause accidents.

- Always drive as carefully and responsibly as possible.

**Adjusting a driving profile**

**Fig. 138** In the lower part of the centre console: driving profile selection button.

**Selecting a driving profile**

- Switch the ignition on.
- To change the driving profile, press the driving profile select button »» **Fig. 138** several times.

When changing the driving profile, a message is displayed on the instrument panel display for a few seconds.

When **ECO** or **ECO+** profiles are selected, the corresponding inscription »» Fig. 138 remains on in the selection button of the driving profile.

### Characteristics of driving profiles

**Normal** This driving profile is always adjusted when the drive system is connected. All the power of the electric engine is available. The Climatronic works in normal mode. When the **Normal** profile is selected, the **Driving Mode Normal** message appears on the instrument panel display.

**ECO** In the **ECO** driving profile, the power of the electric engine is limited to favour lower energy consumption. The maximum speed is reduced. The Climatronic switches to Eco mode, optimal for low consumption, in which the fan and the defrosting/demisting functions are still available. When the **ECO** profile is selected, the **Driving Mode Eco** message appears on the instrument panel display.

**ECO+** In the **ECO+** driving profile, the power of the electric engine is limited even more to favour even lower energy consumption. The maximum speed is reduced. The heating and cooling functions of the Climatronic are disconnected; the fan and the defrosting/demisting functions are still available. When the

**ECO+** profile is selected, the **Driving Mode Eco+** message appears on the instrument panel display.

### WARNING

The driving properties may change depending on the selected driving profile. Never allow the selection of the driving profile to induce you to take any risk that compromises safety.

- Adapt your speed and driving style at all times to suit visibility, weather, road and traffic conditions.

### Note

The power limitation of the electric engine in the **ECO** and **ECO+** driving profiles can be cancelled temporarily by pressing the accelerator pedal as far as it will go ("kick-down").

## Driving tips

### Running in

#### Running in new tyres and brake pads

- Replacement of wheel rims and new tyres »» page 187.
- Information about brakes »» page 150.

## Driving on flooded roads

To prevent damage to the vehicle driving on flooded roads, take the following into account:

- The water should never come above the lower edge of the bodywork.
- Drive at pedestrian speed.

### WARNING

After driving through flooded zones, braking effectiveness can decrease if the brake discs or pads are damp »» page 150.

### CAUTION

Driving through flooded areas may damage vehicle components such as the drive system, transmission or electrical system.

### Note

- Check the depth of the water before entering the flooded zone.
- Do not stop in the water, drive in reverse, or stop the drive system.
- Vehicles travelling in the opposite direction cause waves that could exceed your vehicle's critical height.
- Avoid driving through salt water (corrosion) »» page 196.

## Trips abroad

In some countries, certain safety regulations can be in force that differ from the vehicle's technical characteristics. Before travelling abroad, SEAT recommends you consult a technical service about the legal requirements and the following points:

- Does the vehicle need technical modifications for driving abroad, for example, adjustment of the headlamps?
- Does the vehicle have all the tools, diagnostics equipment and spare parts required for inspections and repairs?
- Are there any SEAT dealers in the destination country?
- Will it be possible to find operating fluids that meet SEAT specifications in the country of destination?
- Are special tyres required in the destination country?

### ⓘ CAUTION

**SEAT does not accept liability for any damage to the vehicle due to an inadequate service or the non-availability of genuine spare parts.**

## Driver assistance systems

### Cruise control system (CCS)\*

#### Control lamp



#### It lights up green

The Cruise Control System (GRA) is switched on and active.

The control lamps light up when the ignition is switched on and should turn off after approximately 2 seconds. This is the time taken for the function check.

#### ⚠ WARNING

**Observe the safety warnings »» ⚠ in Control and warning lamps on page 66.**

#### Introduction

The cruise control system (CCS) is able to maintain the set speed from 20 km/h (15 mph).

The CSS only reduces vehicle speed by ceasing to accelerate, not by actively braking the vehicle »» ⚠.

#### Travelling down hills with the CCS

If the GRA cannot maintain a constant vehicle speed downhill, brake and connect the brake energy recuperation. The GRA is temporarily disabled by pressing the brake.

#### Automatic off

The GRA disconnects automatically or is temporarily interrupted:

- If the system detects a fault that could affect the working order of the CCS.
- If you press and maintain the accelerator pedal for a certain time, driving faster than the stored speed.
- If the dynamic driving control systems intervene, ASR, ESC, etc.
- If the brake pedal is pressed.
- If the airbag is triggered.
- If the lever is taken out of the D/B position.
- If the emergency braking function in the city brakes the vehicle.

#### ⚠ WARNING

**Use of GRA could cause accidents and severe injuries if it is not possible to drive at a constant speed maintaining the safety distance.**

- **Do not use GRA in heavy traffic, if the distance from the vehicle in front is insufficient, on steep roads, with several bends or**

in slippery circumstances or on flooded roads.

- Never use the CCS when driving off-road or on unpaved roads.
- Adapt your speed and the distance to the vehicles ahead in line with visibility, weather, the condition of the road and the traffic situation.
- To avoid unexpected operation of the cruise control system, turn it off every time you finish using it.
- It is dangerous to use a set speed which is too high for other conditions.
- If driving down a steep gradient, the GRA cannot maintain a constant speed. The speed can increase. In this case, reduce the speed by braking or connecting the brake energy recuperation.

## Operating the cruise control with the turn signal lever

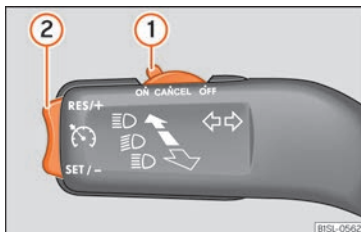

**Fig. 139** On the turn signal lever: controls for operating the GRA.

### Connecting

- Move the control »»» **Fig. 139** ① to **ON**.

If no speed has been programmed, the system will not control it.

### Activating the cruise control

- Press button »»» **Fig. 139** ② in area **SET/-**.

The current speed is stored and the cruise control is activated.

### Temporarily interrupting

- Move the control »»» **Fig. 139** ① to **CANCEL** or step on the brake.

The cruise control system is switched off temporarily. The speed is stored.

### Reinstating the cruise control

- Press button »»» **Fig. 139** ② in area **RES/+**.

Cruise control is activated at the stored speed.

### Adjusting the speed

While the GRA is set, the stored speed can be adjusted with button »»» **Fig. 139** ②:

- To increase in increments of 1 km/h [1 mph] briefly press button »»» **Fig. 139** ② in the area **RES/+**.
- To increase the speed without interruption, keep button »»» **Fig. 139** ② pressed down in the area **RES/+**.
- To reduce in increments of 1 km/h [1 mph] briefly press button »»» **Fig. 139** ② in the area **SET/-**.
- To reduce the speed without interruption, keep button »»» **Fig. 139** ② pressed down in the area **SET/-**.

The vehicle adapts the current speed by accelerating or stopping accelerating. The vehicle does not brake actively.

### Switching off

- Move control »»» **Fig. 139** ① to **OFF**.

»

The system is disconnected and the memorised speed is deleted.

## Lane Assist\*

### Introduction



**Fig. 140** On the windscreen: field of vision of the Lane Assist system.

The Lane Assist System helps the driver stay in their lane. This function is not suitable and is not designed to keep the vehicle automatically in the lane.

Using the camera located in the windscreen, the Lane Assist system detects the possible lines dividing the lanes. When the vehicle involuntarily approaches a dividing line it has detected, the system notifies the driver with a *corrective steering movement*. This movement can be over-regulated at any time.

No warning is produced with the turn signals activated, given that the Lane Assist system understands that a lane change is required.

### System limits

Use the Lane Assist system only on large, well-maintained motorways and highways.

The system is not available under the following conditions:

- The driving speed allowed is below 55 km/h (32 mph).
- The system has not detected any lane lines.
- Temporarily in very sporty driving situations.

### Control lamp



**It lights up green**

Lane Assist system active and available.



**It lights up yellow**

The Lane Assist system intervening with a rectification of the steering.

If the corresponding warning lamp does not light up on the instrument cluster, this can mean that:

- The minimum speed has not been reached.

- The system does not recognise the lane lines.
- Or the system is not available.

If the latter persists, go to a specialised workshop to repair the fault.

Some control and warning lamps will light up briefly when the ignition is switched on to check certain functions. They will switch off after a few seconds.

### ⚠ WARNING

Observe the safety warnings » ⚠ in Control and warning lamps on page 66.

### Operating mode



**Fig. 141** In the centre console: button to connect the lane assist system

### Connecting and disconnecting the lane assist system

The lane assist system is always activated when the ignition is switched on. Pressing the button  **OFF** » Fig. 141 enables to deactivate the assist system until the next time the engine is started.

The button  **OFF** » Fig. 141 is backlit if the system has been disconnected or has a fault.

The Lane Assist system can actively intervene as of approximately 60 km/h (35 mph) if it has detected lane lines.

If the control lamp  of the instrument panel display is off, it means that the assist system is connected but not ready to adjust steering (system in passive state) or disconnected.

When you activate a turn signal, the system temporarily goes into a passive state in order to allow manual lane change.

### Driver intervention prompt

If the steering is not corrected manually, the system prompts the driver through an indication on the instrument panel display and acoustic warnings to actively take the steering wheel.

If no reaction is obtained from the driver, the system switches to a passive state.

Through an indication on the instrument panel display and acoustic warnings, the driver is

also prompted to drive through the centre of the lane if the steering correction lasts more than reasonable.

### Steering wheel vibration

If the system stops displaying the lane lines while assisting with steering, it can cause the steering wheel to vibrate. This situation requires the driver to actively assume control.

### Switching off the Lane Assist system in the following situations

Due to the limits of the Lane Assist system, switch it off in the following situations:

- When more attention is required of the driver
- When driving in a sporty style
- In unfavourable weather conditions
- On roads in poor condition
- In areas of road works

### **WARNING**

The intelligent technology in the Lane Assist system cannot change the limits imposed by the laws of physics and by the very nature of the system. Careless or uncontrolled use of the Lane Assist system may cause accidents and injury. The system is not a replacement for driver awareness.

- Always adapt your speed and the distance to the vehicles ahead in line with visibility, weather conditions, the condition of the road and the traffic situation.
- Always keep your hands on the steering wheel so it can be turned at any time.
- The Lane Assist system does not detect all road markings. The road surfaces, road structures or objects in poor condition can be incorrectly detected as road markings under certain circumstances by the Lane Assist system. In such situations, switch the Lane Assist system off immediately.
- Please observe the indications on the instrument panel and act as is necessary.
- In the following situations there may be counter-productive interventions of the system or it may be that the system does not intervene at all. In these situations, special attention is required from the driver and, where appropriate, the temporary deactivation of the lane assist warning system:
  - In very sporty driving situations.
  - In adverse weather conditions and roads in poor condition.
  - When passing through areas undergoing works.
  - Before gradient changes of grade and river beds.
- Always pay attention to the vehicle's surroundings. »

- When the area of vision of the camera becomes dirty, covered or is damaged, the Lane Assist system function can be affected.

### ⓘ CAUTION

In order to avoid influencing the operation of the system, the following points must be taken into account:

- Regularly clean the area of vision of the camera and keep it in a clean state, without snow or ice »» Fig. 140.
- Do not cover the area of vision of the camera.
- Check that the area of vision of the wind-screen camera is not damaged.

### ⓘ Note

- The Lane Assist system can be automatically disconnected if it registers a fault.
- The lane departure warning system has been exclusively developed for driving on paved roads only.
- If the Lane Assist system does not work as described in this chapter, do not use it and contact a specialised workshop.
- If there is a fault in the system, have it checked by a specialised workshop.

## Braking and parking

### Braking system

#### Control lamps

##### ⓘ It lights up red

Brake fluid level is too low »» page 180; or, failure in the braking system.

⚠ Do not carry on driving!

##### Ⓟ It lights up red

Handbrake applied »» page 152.

The warning lamp turns off when the handbrake is released.

#### ⚠ WARNING

- If the brake warning lamp ⓘ does not go out or if it lights up when driving, the brake fluid level in the reservoir is too low so there is a risk of an accident »» page 180, Brake fluid. Stop the vehicle and do not drive on. Obtain technical assistance.
- If the brake warning lamp lights up ⓘ together with the ABS lamp Ⓜ this could be due to an ABS fault. When this function fails, the rear wheels can lock up. Under certain circumstances, the rear of the vehicle may skid, with the danger of losing control. Stop and seek technical assistance.

### Information about the brakes

#### New brake pads

For the first 200 to 300 km (100 to 200 miles), new brake pads have not yet reached their maximum braking capacity, and need to be "run in" first. However, you can compensate for the slightly reduced braking effect by applying more pressure on the brake pedal. Avoid overloading the brakes while running them in.

#### Wear

The rate of wear on the **brake pads** depends a great deal on how you drive and the conditions in which the vehicle is operated. This is a particular problem in urban traffic and short stretches, or with very sporty driving.

Depending on the speed, the braking force and the environmental conditions (e.g. temperature, air humidity, etc.) noises may be produced when braking.

#### Wet roads or road salt

In certain situations (for example, on driving through flooded areas, in severe downpours or after washing the vehicle) the braking action could be delayed if the discs and pads are damp, or frozen in winter. In this case the brakes should be "dried" by pressing the brake pedal several times.



At high speed and with the windscreen wipers activated, the brake pads will briefly touch the brake discs. This takes place, although unnoticeable to the driver, at regular intervals to improve the response time of the brakes when they are wet.

The effectiveness of the brakes can also be temporarily reduced if the vehicle is driven for some distance without using the brakes when there is a lot of salt on the road in winter. The layer of salt that accumulates on the discs and pads can be removed by gently applying the brakes a few times.

### Corrosion

There may be a tendency for corrosion to form on the discs and dirt to build up on the brake pads if the vehicle is used infrequently or the brakes are not used very often.

If the brakes are not used frequently, or if rust has formed on the disks, it is advisable to clean off the pads and disks by braking firmly a few times at a moderately high speed »» » ⚠.

### Fault in the brake system

If the brake pedal travel should ever increase *suddenly*, this may mean that one of the two brake circuits has failed. Drive immediately to the nearest specialised workshop and have the fault repaired. Drive there slowly and remember that you will have to apply more

pressure on the brake pedal and allow for longer stopping distances.

### Low brake fluid level

Malfunctions can occur in the brake system if the brake fluid level is too low. The brake fluid level is monitored electronically.

### Brake servo

The electromechanical brake servo increases the pressure that you exert when you press the brake pedal. It only works when the vehicle's ignition or drive system is switched on.

### ⚠ WARNING

**Any anomaly in the brake system can increase the braking distance, with the resulting risk of an accident.**

- New brake pads and discs must be run in and do not have the correct friction during the first 200 km (124 miles). This reduced braking capacity may be offset by pressing on the brake pedal a little harder.
- If you are driving on roads which have been salted, braking effectiveness may be decreased.
- Brakes can overheat if used excessively on slopes. Before descending a long, steep gradient, slow down and select a higher recuperation level »» » page 134. Therefore, using the engine brake relieves the brakes.

- Gentle continuous braking causes the brakes to overheat and the braking distance will increase. Apply and then release the brakes alternately.
- Apply the brakes heavily to clean the brake system only in a suitable traffic situation. Do not put other road users in danger: there is risk of causing an accident.
- Ensure the vehicle does not move while in neutral, when the engine is stopped. The braking distance is increased considerably when the brake servo is not active.
- If the brake is subjected to high stresses, vapour bubbles may form in the brake system's pipes. This reduces the efficiency of the brakes.
- Non-standard or damaged front spoilers could restrict the airflow to the brakes and cause them to overheat. Before purchasing accessories please read the relevant instructions.

### ⓘ CAUTION

- Never let the brakes "drag" by leaving your foot on the pedal when it is not necessary to brake. This overheats the brakes, resulting in longer stopping distances and greater wear.
- Before descending a long, steep gradient, we recommend slowing down and selecting a higher recuperation level »» » page 134. This makes use of engine braking and relieves the brakes. If you still have »

to use the brakes, it is better to brake firmly at intervals than to apply the brakes continuously.

#### Note

- If the brake servo is out of action, for example when the car is being towed, you will have to press the brake pedal considerably harder than normal to make up for the lack of servo assistance.
- If you wish to equip the vehicle with accessories such as a front spoiler or wheel covers, it is important that the flow of air to the front wheels is not obstructed, otherwise the brakes can overheat.

## Handbrake



**Fig. 142** Handbrake between the front seats.

The handbrake should be applied firmly to prevent the vehicle from accidentally moving.

Apply the handbrake when you leave your vehicle and when you park.

### Applying the handbrake

- Pull the handbrake lever up »» Fig. 142. The handbrake is set when the control lamp  lights up.

### Releasing the handbrake

- Pull the lever up slightly and press the release knob in the direction of the arrow »» Fig. 142 and guide the handbrake lever down fully »» .

Always pull the handbrake *all the way up*, to avoid driving off while the brake is on »» .

### WARNING

- Never use the handbrake to stop the vehicle when it is in motion. The braking distance is considerably longer, because braking is only applied to the rear wheels. Risk of accident!
- Failure to fully lower the handbrake lever can affect the operation of the system, and can also cause heating and wear of the rear brakes.

### CAUTION

Do not forget to apply the handbrake whenever you leave the vehicle, and put the selector lever in the P position.

## Stabilisation and brake assistance systems

### Control lamps

#### It lights up

Fault in the ESC or ABS, or disconnection caused by the system.  
The ESC works in combination with the ABS. If the ABS fails, the lamp also lights up.

#### Flashes

ESC or ASR activated.

#### It lights up

Fault in the ASR or disconnection caused by the system.

#### Flashes

ASR working.

#### It lights up

ABS faulty or does not work.

The control lamps light up together when the ignition is switched on and should turn off after approximately 2 seconds. This is the time taken for the function check.

**⚠ WARNING**

Observe the safety warnings »» ⚠ in Control and warning lamps on page 66.

**Brake assist systems****Electronic Stability Control (ESC)\***

The ESC helps to improve safety. It reduces the tendency to skid and improves the stability and roadholding of the vehicle. The ESC detects critical handling situations, such as vehicle understeer or oversteer, or wheelspin on the driving wheels. It stabilises the vehicle by braking individual wheels or by reducing the engine torque. The warning lamp will flash on the instrument panel when the ESC is intervening.

The ESC includes the anti-lock brake system (ABS), the hydraulic brake assist (HBA), the traction control system (ASR) and the electronic differential lock (EDS)

ESC also helps stabilise the vehicle by changing the torque.

**Anti-lock brake system (ABS)**

ABS prevents the wheels from locking up under braking until the vehicle has reached a virtual standstill. You can continue to steer the vehicle even when the brakes are on full. Keep your foot on the brake pedal and do not

pump the brakes. You will feel the brake pedal pulsate while the ABS is working.

If the running gear or brake system is modified, the effectiveness of the ABS could be severely limited.

**Hydraulic Brake Assist (HBA)\***

The brake assist system can reduce the required braking distance. The braking force is automatically boosted if you press the brake pedal quickly in an emergency. You must keep pressing the brake pedal until the danger has passed.

**Traction control system (ASR)**

In the event of wheelspin, the traction control system reduces the engine torque to match the amount of grip available. This helps the car to start moving, accelerate or climb a gradient.

**Electronic differential lock (EDL)\***

When the EDL detects wheelspin, it brakes the spinning wheel and directs the power to the other driven wheel. This function is active up to approximately 100 km/h (62 mph).



To prevent the disc brake of the braked wheel from overheating, the EDL cuts out automatically if subjected to excessive loads. The vehicle can still be driven. The EDL will switch on again automatically when the brake has cooled down.

**Electronic brake pressure distribution (EBV)**

In all vehicles, when the brakes are applied, the centre of gravity of the vehicle moves forward. As a consequence, there is a danger that the rear wheels may lock due to their low traction. The electronic brake pressure distribution controls the brake pressure for the rear wheels and ensures that this pressure is distributed optimally between the front and rear axles. Under normal circumstances it prevents the rear part of the vehicle from skidding due to excessive braking of the rear wheels. The function of the electronic brake pressure distribution is incorporated in the ABS function.

**Electromechanical brake servo (eBKV)**

With the ignition switched on, the electromechanical brake servo supports the force of the foot by increasing the pressure that the driver exerts on the brake pedal. After disconnecting the ignition, the assistance of the brake servo is progressively reduced. Once stopped, immobilise the vehicle to prevent it from moving »» page 154.

If the electromechanical brake servo does not work, the yellow control lamps  and  on the instrument panel display light up at the same time. When braking with the faulty electromechanical brake servo, vibration of the brake pedal may occur. »

If the electromechanical brake servo is not working, the brake pedal must be pressed harder, as the braking distance increases due to the lack of assistance from the servo brake.

### Brake blending

The brake energy recuperation can generate a braking effect »» page 134. This braking effect depends on the selected driving programme and the level of charge of the high-voltage battery. If the braking effect caused by the recuperation is very intense, the vehicle's brake lights with turn on. The electric engine, when operating as an alternator, can generate braking torque on the front wheels based on the RPM and the temperature and charge level of the high-voltage battery.

These variable parameters cause fluctuating electric decelerations which are hydraulically compensated according to the driver's desires. This function is called "brake blending" and it combines mechanical braking with the engine brake effect.

### WARNING



**Driving at high speed on icy, slippery wet ground can result in loss of vehicle control and serious injury to the driver and passengers.**

- The ESC, ABS, ASR, EDS or HBA systems are neither in conditions to exceed the limits established by the laws of physics. Always bear this in mind, especially on wet or

slippery roads. If you notice the systems cutting in, you should reduce your speed immediately to suit the road and traffic conditions. Do not be encouraged to take risks by the presence of more safety systems. If you do, an accident may occur.

- Please remember that the accident risk always increases if you drive fast, especially in corners or on a slippery road, or if you follow too close behind the vehicle in front of you. The ESC, ABS, ASR, EDS or HBA system cannot prevent accidents from occurring: risk of accidents!
- Accelerate with caution on slippery surfaces (for example, icy or snow-covered). Despite the control systems, the driven wheels could spin, affecting the stability of the vehicle: risk of accident!

### Note

- The ABS and ASR will only operate correctly if the four wheels have identical tyres. Any differences in the rolling radius of the tyres can cause the system to reduce engine power when this is not desired.
- The regulating processes of the systems can make noises due to their operation.
- If the warning lamp  or  lights up, there could be a fault »» page 65.
- Any modifications made to the vehicle (for example, to the engine, brake system, running gear or to the combination of

wheels and tyres) may affect the operation of the ABS, ASR and EDS.

## Parking

### To park the vehicle

When parking your vehicle, all legal requirements should be observed.

Always note the following points when parking the vehicle:

- Park the vehicle on a suitable surface »» 
- Apply the handbrake »» page 152.
- Set the selector lever to the **P** position.
- Connect the drive system.
- Turn the steering wheel slightly to engage the steering lock.
- When leaving the vehicle, take all keys with you.

### Additionally, on steep slopes and inclines

Before switching off the engine, rotate the steering wheel so that if the vehicle should move, it will be held by the kerb.

- On slopes, turn the front wheels so that they are against the edge of the kerb.
- Uphill, turn the wheels towards the centre of the road.

### WARNING

- Avoid parking the vehicle where the hot exhaust system could ignite inflammable materials, such as dry grass, low bushes, spilt fuel or flammable materials.
- Do not leave passengers inside a closed vehicle, they may not be able to open doors or windows. Locked doors hinder the possibility of a rescue.
- Children should not be left alone in the vehicle. They could tamper with the hand-brake or the gears, which could cause the vehicle to move without control.
- Depending on weather conditions, it may become extremely hot or cold inside the vehicle. This can be fatal.

## Help with parking and manoeuvring

### Parking distance warning system\*

#### Introduction

The parking distance warning system assists the driver when parking. If the rear of the vehicle is approaching an obstacle, an intermittent audible warning is emitted. The shorter the distance, the shorter the intervals between tones. If the vehicle is too close to the obstacle, the audible warning becomes constant.

If you continue to approach an obstacle when the sound is continuous, this means the system can no longer measure the distance.

Sensors situated on the rear bumper transmit and receive ultrasound. Using the ultrasound signal (transmission, reflection from the obstacles and reception), this system continuously calculates the distance between the bumper and the obstacle.

### WARNING

The parking distance warning system cannot replace the driver's assessment of the situation.

- The sensors have blind spots in which obstacles and people are not registered.
- Always observe the area around the vehicle, as the sensors do not always detect small children, animals or objects.
- The surface of certain objects and some clothing do not reflect the ultrasound signals from the parking distance system. The system cannot detect or incorrectly detects these objects and people wearing these types of clothes.
- External sound sources can affect the parking distance aid signals. In this case, under certain circumstances, people and objects will not be detected.

### CAUTION

- The sensors may not always be able to detect objects such as trailer draw bars, thin rails, fences, posts, trees and open boots, etc. This could result in damage to your car.
- Although the parking distance warning system detects and warns of the presence of an obstacle, the obstacle could disappear from the angle of measurement of the sensors if it is too high or low and the system would no longer show it. Therefore, it will not warn you of these objects. Ignoring the warnings of the parking sensor system could cause considerable damage to the vehicle. »

- The bumper sensors may become damaged or misaligned, for example, when parking.
- To ensure that the system works properly, the bumper sensors must be kept clean, free of ice and snow and uncovered.
- When cleaning the sensors with high-pressure or steam cleaning equipment, spray the sensors briefly at a distance of no less than 10 cm.
- Different sources of noise can produce errors in the parking distance warning system, e.g. parking distance warning systems from other vehicles, inductive loops or construction works machines.
- Retrofitting of components to the vehicle, such as a bicycle carrier, may interfere with the function of the parking distance warning system.

### Parking distance warning system

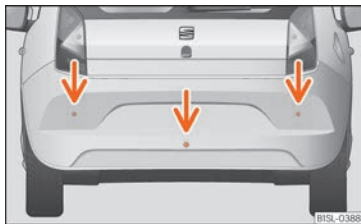

**Fig. 143** Parking distance warning system sensors on the rear bumper

The sensors of the parking distance warning system are situated on the rear bumper  
 ))) **Fig. 143.**

#### Switching the parking distance warning system on and off

- **Switch on:** With the ignition switched on, select reverse gear. A short audible warning confirms that the parking distance warning system is switched on and functioning.
- **Switch off:** Release reverse gear.

#### Special features of the parking distance warning system

- The parking distance warning system sometimes registers water on the sensors as an obstacle.

- If the distance does not change, the warning signal will sound less loudly after a few seconds. If the continuous signal sounds, the volume will remain constant.
- When the vehicle moves away from the obstacle, the beeping sound automatically switches off. When getting close again, it re-connects.
- Your SEAT dealership can adjust the volume of the warning signals.

#### Note

A fault in the parking distance warning system is indicated through a brief audible warning that is constant for about 3 seconds when switching it on the first time. Have the parking distance warning system checked as soon as possible at a specialised workshop.

### Optical parking system\* (OPS)

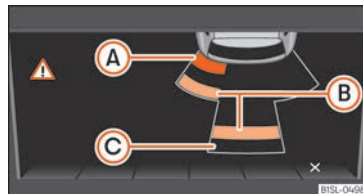

**Fig. 144** On-screen OPS display

- A** An obstacle was detected in the collision area
- B** An obstacle was detected in the segment
- C** Zone behind the vehicle registered

The optical parking system is an extension of the parking distance warning system  
»» page 156.

The radio screen displays the area behind the vehicle recorded by the sensors. Any obstacles are displayed in relation to the vehicle  
»» .

#### Connect the indication

- Activate the parking distance warning system »» page 156. The OPS switches on automatically.

#### Manually disconnect the indication

- Remove reverse gear.

#### Zones explored

The approximate measurement range of the sensors is:

Rear area: 1,50 m

Rear side area: 0,60 m

#### Screen display

The image displayed represents the superimposed zones in several segments. As the vehicle approaches an obstacle, it approaches

the displayed vehicle segment »» Fig. 144 **A** or **B**. Ultimately, when the second-to-last segment is shown, the collision area has been reached. **Stop the vehicle!**

#### Segment colours (colour display)

**Yellow** The distance to the obstacle behind is approximately **31-150 cm**. The audio signal is intermittent.

**Red** The distance to the obstacle behind is approximately **0-30 cm**. The audio signal is continuous.

#### WARNING

**Do not be distracted from traffic to look at the display.**

#### Note

- SEAT recommends practising using the parking distance warning system in a traffic-free zone or in a car park to familiarise yourself with the system and its operation.
- The display on the radio display of the area explored by the sensors may take up to 5 seconds.

## Towing bracket device

### Trailer mode

#### Information on driving with a trailer

The vehicle is **not** certified for trailer coupling. The vehicle is not factory-equipped with a towing bracket, nor is it possible to retrofit it.

#### WARNING

**Installing a towing bracket on the vehicle may cause accidents and serious injuries while operating the vehicle.**

- Never install a towing bracket on the vehicle.
- The trailer may be released from the vehicle when the vehicle is moving.

#### CAUTION

**Any type of towing bracket installed on the vehicle can cause serious and costly damage that are not covered under the SEAT guarantee.**

## Practical tips

### High-voltage battery

#### Safety warnings relating to the high-voltage network and the high-voltage battery

##### Introduction



**Fig. 145** Warning signs [schematic representations]: [A] High-voltage components. [B] General high-voltage warning sign. [C] High-voltage battery warning sign.



**Fig. 146** When charging, in the engine compartment: hot surface warning.

##### Overview of the high-voltage system

The high-voltage system is made up by, among others, the following components:

- High-voltage battery
- Electronic power module
- Electric engine
- High-voltage air conditioning compressor

- High-voltage battery charger
- High-voltage battery charging socket
- Orange coloured high-voltage cables and connectors
- High-voltage heater

The works that are to be carried out on the high-voltage system should be performed exclusively by a specialised workshop with duly



qualified technical staff, trained according to the SEAT guidelines »» page 174 .

Handling the warning signs and stickers »» page 205.

### General high-voltage warning signs

The high-voltage warning signs »» Fig. 145 [A] and [B] warn of the existence of high electrical voltage »» ⚠. The following vehicle parts may come with these warning signs:

- The covers and lids behind which there are high-voltage components under high-voltage.
- All the high-voltage components, including the high-voltage battery.
- The lock carrier, in the engine compartment.

### High-voltage battery warning sign

The high-voltage battery comes with a sign that warns of its hazards.

Key to »» Fig. 145 [C]

- ① High-voltage can cause serious injuries or even death. Never touch the battery poles with bare fingers, tools, jewellery or other metal objects.
- ② The high-voltage battery contains hazardous liquid and solid substances. In the event of gases emitting from the battery, these could cause serious burns and

blindness. When performing works on high-voltage battery, always use appropriate eye protection and protective clothing to avoid skin and eyes from coming into contact with the battery fluid. If the battery fluid were to come into contact with skin or eyes, immediately rinse the affected area with clean water for at least 15 minutes and seek medical assistance.

- ③ The high-voltage battery may burn. Never expose the high-voltage battery to sources of fire, sparks or unprotected flames. Always handle the high-voltage battery with care to avoid damaging it and, consequently, fluid from leaking.
- ④ Always keep children away from the high-voltage battery.
- ⑤ The instruction manual and the workshop information contain further information and warnings to this regard.
- ⑥ An inappropriate handling of the high-voltage battery can cause serious injuries or death. Never remove the cover from the high-voltage battery and never remove the high-voltage battery.
- ⑦ An inappropriate handling of the high-voltage battery can cause serious injuries or death. All maintenance works involving the high-voltage battery should **only** be performed by duly qualified and trained technical staff ⚠. Never modify the high-voltage battery in any way. When the

high-voltage battery is open, ensure it does not come into contact with water or other liquids. Liquids may cause short circuits, electrical shocks and burns.

### ⚠ WARNING

**The vehicle's high-voltage network and the high-voltage battery are hazardous and can cause burns, other injuries and an electrical shock with deadly consequences.**

- **Always consider that the high-voltage battery is fully charged and that all the high-voltage components are powered. This may be the case even with the electric drive system and the ignition disconnected.**
- **Never touch the high-voltage cables or the high-voltage battery and its poles, and never touch them with jewellery or other metal objects, especially when the cables, battery and its poles are damaged.**
- **Never take it upon yourself to perform any type of work on the high-voltage network, on the high-voltage cables or the high-voltage battery.**
- **Never open the components or parts of the high-voltage network. Never perform any maintenance work on these elements, nor repair or uncouple the high-voltage network.**
- **Never damage, modify or remove the orange coloured high-voltage cables, and**

»

never uncouple them from the high-voltage network.

- Never open, modify or remove the cover from the high-voltage battery.
- Only duly qualified and trained technicians are authorised to perform works on the high-voltage system and on any other systems on which these may have indirect influence.
- To perform works close to high-voltage components and cables which require the use of sharp tools, which may deform or release shavings, or sources of heat, such as works involving welding, soldering, use of hot air or thermal gluing, you must first ensure the system is not powered. Only duly qualified and trained technicians are authorised to leave the high-voltage system without power.
- When performing any work on the high-voltage system and the high-voltage battery, ensure you bear in mind the SEAT guidelines and standards.
- Keep the vehicle key in a safe place at a safe distance from the vehicle to prevent the ignition from turning on by mistake.
- The gases that are released or leaked from the high-voltage battery may be toxic or flammable.
- Any damage caused to the vehicle or the high-voltage battery may lead to an immediate or subsequent leak of toxic gases. These gases can also cause a fire. In the

event of any damage, always open the vehicle windows so the gases can flow out of the vehicle. Do not inhale the gases.

- Never touch the fluids or come into contact with the gases that may be released from the high-voltage battery, especially if the battery has been damaged.
- In the event of a fire, leave the danger area and call the fire department. Inform the fire fighters that the vehicle is fitted with an electric drive system.
- Always inform the emergency service that the vehicle is fitted with a high-voltage battery.

### WARNING

If works are performed on the high-voltage system and on the high-voltage components in an inappropriate manner, this may lead to faults in the operation, accidents and injuries.

- Only duly qualified and trained technicians are authorised to perform works on the high-voltage system and on any other systems on which these may have indirect influence.

### WARNING

Electric vehicles do not make any noise when the vehicle is not moving and very little noise when the vehicle is moving. Hence other road users, such as pedestrians or

children, cannot hear or perceive their presence, or they do so with difficulty. This may lead to accidents and cause injuries, for example, in residential areas, when manoeuvring or moving in reverse gear.

### CAUTION

After an accident or having hit an obstacle with the vehicle underside, the high-voltage battery must be checked by duly qualified and trained technicians.

## Charging the high-voltage battery

### Control lamps



Its lights up yellow. The charge level display needle is in the area marked in red.

The high-voltage battery charge has reached the reserve level.  
Charge the high-voltage battery.



**Its lights up yellow. A text message will also appear on the instrument panel display.**

The **Eco** or **Eco+** driving profile will be active. The power is reduced and certain consumers are automatically switched off, such as the air conditioning system. The vehicle may already be travelling in reserve mode.

The high-voltage battery charge has reached the reserve level. The vehicle autonomy will only be of a few kilometres.

Charge the high-voltage battery immediately.



**Its lights up yellow.**

The power is reduced and there is very little autonomy.

A text message will also appear on the instrument panel display.

The maximum speed is limited to 80 km/h [50 mph]. The **Eco+** driving profile will be active.

The high-voltage battery is discharged. There is only sufficient autonomy for a few hundred metres. Stop the vehicle in a safe place. Charge the high-voltage battery immediately.

The control lamps light up together when the ignition is switched on and should turn off after approximately 2 seconds. This is the time taken for the function check.

### **⚠ WARNING**

**Observe the safety warnings** » **⚠** in Control and warning lamps on page 66.

## Introduction

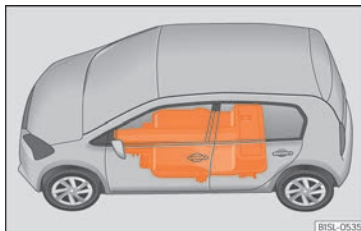

**Fig. 147** On the vehicle floor: location of the high-voltage battery.

The vehicle's electric engine is operated by the high-voltage battery, which is located on the vehicle floor » **Fig. 147**.

The high-voltage battery can either be charged immediately or programmed » **page 167**. Always bear in mind the safety warnings » **⚠**.

Before charging the battery, disconnect the drive system » **page 137**.

### Charge options

- Charge from a power socket or a charging station ("alternating voltage") » **page 164**
- Home charging station (wallbox) ("alternating voltage") » **page 166**
- Fast charge at a charging station ("direct current") » **page 165**

To charge the high voltage battery with alternating current, SEAT recommends using an alternating current charging station with more than 3.6 kW. This charging method is more efficient than using a socket.

### Protection against fault current

The vehicle is fitted with a device to provide protection against fault direct current [fault DC current]. This avoids the fault DC currents, which may be caused during charging, to reach the electrical installation of the home through the charging cable and for them to damage the operation of the differential switch (in Germany, for example, the differential switch is A type) while charging.

### Night power rates

There are electricity suppliers that offer cheaper night power rates that can be used to charge the high-voltage battery. To take advantage of these periods of time, it is possible to programme the preferred time for charging the vehicle using the **Energy management** or at the home charging station (wallbox).

### High-voltage battery warranty

The warranty covering new SEAT vehicles also includes the vehicle's high-voltage battery » **page 196**.

Batteries age based on their use and their operating time. It is advisable that you know certain details regarding the correct handling and care of the high-voltage battery so this remains in good condition for longer and can be used in a reliable manner. Carefully read the following information and take into account the indications when using the vehicle.

### WARNING

If the battery is charged in an inappropriate manner, if no consideration is given to the general safety measures, power sockets and charging cables in poor condition are used or the high-voltage battery is used in an inadequate manner, this could lead to short circuits, electrical shocks, explosions, fires, burns and serious injuries, even death.

- Always respect the stipulated order of the operations to avoid the risk of suffering an electrical shock or serious injuries due to the residual energy in the charge accumulator! Never unplug the connector from the electrical network during the charge process.
- Only connect the charging cable to a power socket that is protected from water, humidity and other liquids.
- When charging, only use power sockets that are appropriately fitted, have been checked and are not damaged, as well as electrical installations that are in perfect working order. Duly qualified technicians

should check the power sockets and the electrical installation on a regular basis.

- Never use damaged charging connectors or cables. Before using the charging connectors or cables, always check they are not damaged.
- Only use the charging cables supplied with the vehicle or the charging station cable. In the event of needing replacement, we recommend you only use SEAT charging cables.
- Never modify or repair the electrical components, especially those belonging to the high-voltage system.
- Never charge the vehicle in places where there is a danger of explosion. The components of the charging cable can cause sparks and, therefore, may ignite flammable fumes or explosives.
- Never use the charging cable in combination with an extension cable, a cable reel, a power strip or an adapter, such as a travel adapter or a timer.
- Always protect the connectors from humidity, water and other liquids.
- For safety reasons, never perform other works on the vehicle while charging.
- Always complete the charging process before unplugging the connector from the electrical network. Otherwise the charging cable and the electrical installation may also be damaged.

- Always remove the charging cable before starting the vehicle. Place the protective caps and close the cover of the battery charging socket.

- Never charge several vehicles simultaneously from the power sockets of the same protected electrical circuit. To charge other vehicles simultaneously, use another electrical circuit. Always take into consideration the maximum capacity of the electrical circuit used. Given the case, contact duly qualified personnel specialised in electrical installations.

### CAUTION

Charging the high-voltage battery frequently with a high charge power could lead to a permanent reduction in the battery's charge capacity. Charge the high-voltage battery preferably using a low charge capacity, i.e. a home charging station (wallbox) or a power socket that have been checked.

### CAUTION

Leaving the vehicle parked for a long period of time with the high-voltage battery discharged may cause irreversible damage to the battery.

- Always charge the high-voltage battery immediately.

**Note**

- The high-voltage battery can only be charged at charging stations that meet the following requirements and regulations:
  - IEC 61851 and IEC 62196 (type 2 connector).
- In the event of very low or very high temperatures, it may only be possible to charge the high-voltage battery in a limited manner.
- To avoid possible compatibility problems with charging infrastructures, SEAT recommends the use of cables and home charging stations recommended by the Volkswagen Group.

**Electric range and charge level display**

**Fig. 148** On the instrument panel: indicator of the high-voltage battery charge level with the reserve area marked in red (arrow).

**Range indication**

The vehicle range can be viewed on the instrument cluster screen »» page 59 and on the application available for mobile phones (SEAT CONNECT services »» page 130). The value shown is calculated and updated based on the driving style. Hence, the autonomy may vary even with the high-voltage battery fully charged.

**High-voltage battery reserve level**

The charge level display located on the instrument panel shows the available charge of the battery and the reserve area, marked in red (arrow) »» Fig. 148.

When the high-voltage battery charge level has reached the reserve level, the control lamp lights up yellow.

In this case, the relevant message »» page 160 will appear in the instrument panel display. Several acoustic warnings are also sounded.

Charge the high-voltage battery as soon as possible to avoid the vehicle from stopping.

**⚠ WARNING**

If the vehicle is driven with a very low a charge level of the high-voltage battery, the vehicle may stall in traffic, causing serious damage or accidents and injuries.

- Always ensure that the charge level of the high-voltage battery is sufficient!

**⚠ WARNING**

When the high-voltage battery charge level reaches the reserve level, it is possible that certain driving properties may vary, i.e. the acceleration behaviour of the vehicle.

- Always adapt the speed and driving style to the conditions of visibility, weather, road and traffic, as well as the charge level of the high-voltage battery.

**ⓘ CAUTION**

The self-discharge of the high-voltage battery, for example due to the vehicle being »»

parked for several months, can cause damage to the battery in the event of high ambient temperature and the battery having a low charge level.

- Always ensure that the charge level of the high-voltage battery is sufficient!

**Note**

If the outside temperature is very low and, therefore, the high-voltage battery is very cold, the autonomy may be reduced.

### Charging from a power socket or a charging station (AC)

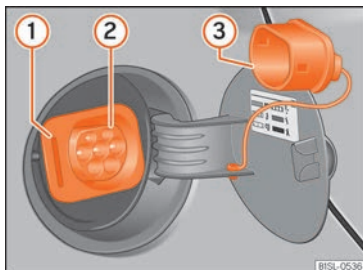

**Fig. 149** Behind the cover of the battery charging socket: charging socket (schematic representation).



**Fig. 150** At the bottom of the centre console: charging mode button.

Key to »» Fig. 149

- ① Charging process display
- ② Charging socket
- ③ Protective cap

The high-voltage battery of the vehicle can be charged using **alternating voltage (AC)** through the corresponding charging socket ②.

Always bear in mind the safety warnings »» page 158 before starting the charging process.

Before charging the battery, always disconnect the drive system »» page 137.

#### Connecting the charging cable

- If on, remove the protective caps.

- First connect the charging cable to the power supply or remove this cable from the charging station.
- Fully unwind the charging cable.
- With the vehicle unlocked, press the cover of the battery charging socket, located at the rear of the right side, to open it »» Fig. 149.
- Plug the charging connector into the charging socket »» Fig. 149 ②.

As soon as the connector is detected, the charging process display lights up yellow »» Fig. 149 ①. The control lamp ② is on in the instrument panel display.

#### Automatic start of the charging process

If the programmed charge is not active, the charging process starts immediately. Make sure the charging station is switched on.

During the charging, the charging connector is locked and cannot be removed.

#### During the charging

During the charging, the charging process display »» Fig. 149 ① flashes green. The control lamp ② flashes yellow on in the instrument panel display.

The remaining charging time is shown on the instrument panel display.

### Pausing or ending the charging process

Press the charging mode button »» Fig. 150 to pause the charging process. The charging connector remains locked. The charging process can be reactivated by pressing the charging mode button again.

If you wish to unplug the charging connector, unlock the vehicle using the key.

### If the charging ends automatically and the high-voltage battery is charged:

- Unlock the vehicle with the ignition switched off.
- Remove the charging connector from the charging socket within 30 seconds.
- Unplug the charging cable from the power supply source.
- If available, replace the protective caps.
- Close the cover of the battery charging socket until you hear it has engaged.

### Charging for the first time and charging after not being used for a long period of time

When the high-voltage battery is new or has not been charged for a long period of time, it is possible that the battery may not reach its maximum charge level until it is charged several times. This is due to technical reasons and has nothing to do with any fault in the vehicle.

If you are not going to use the vehicle for a long period of time, make sure you charge the high-voltage battery within a period of 4 months at the latest.

#### Note

**If once the charge is completed you leave the charging cable connected, the high-voltage battery will not discharge due to the use of the vehicle's electricity consumers.**

### Fast charge at a charging station (CC)

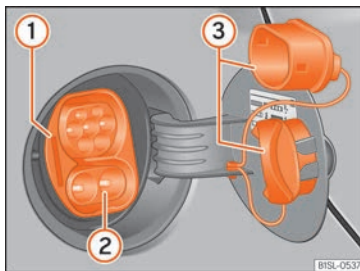

**Fig. 151** Behind the cover of the battery charging socket: charging socket (schematic representation).

Key to »» Fig. 151

- ① Charging process display
- ② Charging socket
- ③ Protective caps

Depending on the equipment, the vehicle can be charged with **direct current (DC)** at a charging station.

Take into account the general information relating to charging the high-voltage battery and the preparations to be carried out before charging »» page 158.

Before charging the battery, always disconnect the drive system »» page 137.

### Connecting the charging cable

Fast charge is carried out through the connection located at the bottom of the charging socket.

- Remove the charging cable from the charging station.
- With the vehicle unlocked, press the cover of the battery charging socket, located on the side panel, to open it »» Fig. 151.
- Remove the two protective caps from the charging socket »» Fig. 151 ③. To remove the bottom protective cap, first remove the top cap.
- Plug the charging connector into the charging socket »» Fig. 151 ②.

»

As soon as the connector is detected, the charging process display lights up yellow. The charging connector is locked. The control lamp  is on in the instrument panel display.



### Automatic start of the charging process

In this case, activate the charging station   
»» .

The charging process will start immediately.



During the charging, the charging connector remains locked and cannot be removed from the charging socket.

### During the charging

During the charging, the charging process display   
»» **Fig. 151**  flashes green. The control lamp  flashes yellow on in the instrument panel display. Do not unplug the charging connector.

The remaining charging time is shown on the instrument panel display.

### Ending the charging process

The charging process can be ended by pressing the charging mode button  located at the bottom of the centre console of the vehicle or directly from the charging station. Unlock the vehicle with the button  on the key or the button  located on the driver's door. The charging process will stop for ap-

proximately 30 seconds and the charging connector will unlock. Remove the charging connector from the charging socket:

- Remove the charging connector from the charging socket.
- Place the protective caps on the charging socket   
»» **Fig. 151** .
- Close the cover of the battery charging socket until you hear it has engaged. The cover should be flush-mounted on the bodywork.

### Emergency release of the charging connector

If it is not possible to remove the charging connector after ending the charging process, perform an emergency release of the same   
»» **page 169** and remove it.

#### CAUTION

To use the charging station, bear in mind the manufacturer's indications and usage instructions.

#### Note

The stationary air conditioning of the vehicle using a charging station is only possible during the charging process. As an alternative, the "Air conditioning without an external power supply" can be set in the energy manager  of the infotainment system.

## Charging at an AC home charging station (wallbox)



**Fig. 152** Home charging station (wallbox).

Charging at a fixed home charging station (wallbox)   
»» **Fig. 152** through the home power supply achieves a higher charging power than using a domestic socket, but not higher than charging with DC   
»» . The charge time diminishes significantly. The device automatically selects the maximum amperage based on the electrical installation of the property.

Bear in mind the procedure to be followed for charging from a power socket or a charging station   
»» **page 164**.

#### CAUTION

The home charging station (wallbox) must be installed by duly qualified technicians.

- Before using the home charging station (wallbox) for the first time, ensure the



property's electrical installation is checked.

- Specialised technicians should check the electrical installation on a regular basis.

### Note

The home charging station (wallbox) can be purchased as an accessory.

- Ask about home charging stations (wallbox) at a SEAT dealer.
- Bear in mind the operating instructions of the home charging station (wallbox) before using it.

## Immediate charging and programmed charging



**Fig. 153** At the bottom of the centre console: charging mode button.

The charge mode button  **Fig. 153** located at the bottom of the centre console can be used to choose between immediate and programmed charging.

### Immediate charging

The charging process of the high-voltage battery starts immediately as soon as the charging cable is connected. The high-voltage battery will fully charge. During this time, the charging mode button  flashes.

Press the charging mode button  to pause the charging process.

If a timer is activated with a departure time, press the charging mode button to change to “programmed charging”.

### Programmed charging

- Open the **e-manager**  in the app (SEAT CONNECT services).
- Select a timer.
- Insert the departure time, being the time at which the high-voltage battery must be charged.
- Activate the timer by ticking the verification box .

If the charge level is very low, the high-voltage battery will start charging immediately until reaching the low charge limit.

If the charging cable is plugged in, the symbol of the charging mode button  **Fig. 153** lights up.

Not all charging stations allow programmed charging.

### Minimum charge limit of the battery

In all charging modes using a power socket, the high-voltage battery will start charging immediately until reaching the low charge limit. This avoids the battery charge level from being too low.

The value can be adjusted in the **e-manager**  of the SEAT CONNECT services.

### Maximum charge limit of the battery

The high-voltage battery will only charge until reaching the set value for the maximum charge limit of the battery. This helps protect the high-voltage battery  **page 160**.

The value can be adjusted in the **e-manager**  of the SEAT CONNECT services.

## Charging process display

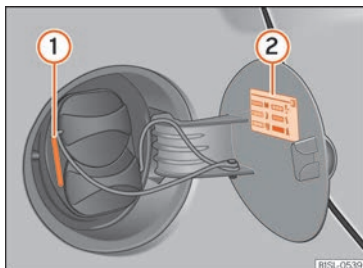

**Fig. 154** Behind the cover of the battery charging socket: charging process indicator ① and information on sticker ②.

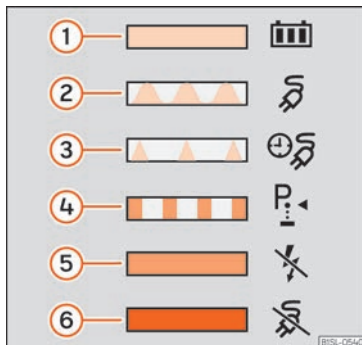

**Fig. 155** On the inside of the cover of the battery charging socket: sticker with information on the charging process display.

The charging process display is a diode (LED) located next to charging socket »» Fig. 154 ① and it indicates the charge level. There is a sticker that explains the different indications »» Fig. 155.

Key to the information sticker of the charging process display »» Fig. 155:

- ① **The green LED lights up permanently:** The charging process of the high-voltage battery is complete. The battery has reached the maximum or set charge level.
- ② **The LED flashes green:** The high-voltage battery is charging.

- ③ **The LED flashes green for about 1 minute:** Programmed charging is active (departure time), but has not yet started »» page 167.
- ④ **The LED flashes yellow:** The parking lock **P** is not engaged.
- ⑤ **The yellow LED lights up briefly:** The charging connector is plugged into the charging socket and the vehicle has detected it.

**The yellow LED lights up permanently:** No electrical network has been detected. Check the power supply and the electrical network. When using the charging cable for the electrical network, the protection device will display the status of the network. Seek specialist assistance.

- ⑥ **The red LED lights up permanently:** It has not been possible to lock the charging connector. Remove the charging connector from the charging socket and plug in again. If the fault continues, seek specialist assistance.

**The LED flashes red:** There is a fault in the charging system. Seek specialist assistance.

When the charging process is active, this is displayed on the instrument panel by means of a control lamp, and on the remaining charge time is also displayed »» page 56.

### Remaining charging time

The vehicle's remaining charging time can be displayed on the instrument cluster display and on the mobile app (SEAT CONNECT services).

The charge can take longer than 10 hours with a charging cable for power sockets.

The e-Manager shows a maximum charging time of 10:30 hours, although it can take longer.

If the charging time is longer than 10:30 hours, the instrument cluster displays >10:30. When the remaining charge time drops below this value, the ">" sign disappears and the time counts down.

While the high-voltage battery is charging, the indicator lamp  (yellow) flashes on the instrument cluster.

### Problems and solutions

#### The charging process will not start or has paused

The relevant text message will appear in the instrument panel display.

- Use another charging source »» page 160.
- **Or:** unplug the charging cable of the vehicle and plug it back in again.

- **Or:** the charging system may be faulty. Contact a specialised workshop.

#### Fast charge is not working

The relevant text message will appear in the instrument panel display.

It is not possible to fast charge using direct current.

Error in the charging system.

- Contact a specialised workshop.
- As an alternative, charge the high-voltage battery using alternating voltage (AC).

#### The charge time is longer when using the fast charge function

The charging current automatically reduces during the charging process.

The high-voltage battery must be protected against overheating when performing several continuous charging cycles, for example, when using the vehicle on a continuous basis and with high ambient temperatures.

### Emergency release of the charging connector



#### Requirements:

- The parking lock **P** is not engaged »» page 140.

- The vehicle is unlocked »» page 69.
- The charging process has ended or has paused »» page 161.

If despite this, it is still impossible to unplug the charging connector, perform an emergency release of the connector.

#### Emergency release of the charging connector

- Press the charging mode button  at the bottom of the centre console and keep it pressed. At the same time, press the central locking button  located on the driver's door.
- Remove the connector from the charging socket.
- Have the vehicle checked by a specialised workshop immediately.

If the problem continues, consult a specialised workshop.

#### Note

**Perform the emergency release of the charging connector only in the event of a fault in the vehicle.**

## Charging cable

### Introduction

The type of charging cable supplied with the vehicle depends on the delivery volume and the specific technical specifications of each country, e.g. charging connector connections for power sockets.

The charging cables supplied from the factory are in the luggage compartment **»» page 89** and should only be transported there.

To charge the high-voltage battery without problems and ensure a long useful life of the charging cables, bear in mind the following information and indications.

SEAT recommends to **only** use the charging cables supplied from the factory.

How to maintain the charging cables in good condition:

- Use them with care.
- Roll them up and roll them out completely.
- Do not twist or bend them over sharp edges.
- Do not crush it and avoid driving the vehicle over it.
- When removing them from the vehicle and from the power supply source, only pull on the connectors.

- Children should not use the charging cable.
- Keep animals away from the charging cable.
- After use, store them safely and without twisting.

How to maintain the protection device and the charging connectors in good condition:

- Do not touch the charging connector's contacts.
- After using the charging cable, replace the protective caps.
- Protect them from intense solar radiation (the outside temperature should not exceed 50°C [122°F]).
- Do not drop them.
- Protect them from immersion in fluids such as rain water.

In the event of operating faults, SEAT recommends the charging cables are checked by one of its dealers.

If there is a fault in the power socket or in the electrical installation, seek assistance from a technician specialised in electrical installations.

### WARNING

**Using a charging cable that has been damaged or tampered with can cause serious injury and fatal electric shocks.**

- Before each use check that the connectors and the charging cable are undamaged, e.g. check for cracks.
- Never use a charging cable that is damaged or has been tampered with.
- If the charging cable does not work properly, get a SEAT dealer to check it.

### WARNING

**Always plug the charging cable for power sockets directly into a power socket. Never use the charging cable in combination with an extension cable, a cable reel, a power strip or an adapter, such as a travel adapter or a timer. Otherwise this could lead to injuries caused by fire or the charging cable or the electrical installation of the property could be damaged.**

### WARNING

**Never charge the battery using unknown power sockets or electrical installations, or those which have not been checked by duly qualified technicians. Even very low charging currents can cause important damages, especially fires, when using power sockets or electrical installations that are in poor condition. In this case, seek assistance from a technician specialised in electrical installations.**

### ⚠ WARNING

Items that are not secured, or incorrectly secured can cause serious injury during sudden manoeuvres or braking, or in the event of an accident.

- Store the charging cable securely in the luggage compartment.
- Use the organizer/protective cover provided with the cable for this purpose.

### ⚠ WARNING

The high voltage system voltage is dangerous and can cause burns, other injuries and fatal electric shocks.

- Only clean the charging cable when it is unplugged.

### ⓘ CAUTION

A specialist in electrical installations should check the charging cable on a regular basis. A tester adapter will be needed to check the charging cables.

### ⓘ CAUTION

The charging cable can be damaged if not cleaned properly.

- Only water should be used for this purpose, and never additional cleaning products.
- Water should be prevented from getting into the contacts.

### ♻ For the sake of the environment

Charging cables must be disposed of in an environmentally friendly way and should not be thrown in the household waste.

### ⓘ Note

Take into consideration the maximum capacity of the electrical circuit used. If the charging cable is plugged in along with other electrical consumers into a power socket on the same electrical circuit, this could cause the fuse to trip. In this case, the high-voltage battery will not charge. Disconnect all other electrical consumers from the electrical circuit or use another circuit. In this case, seek assistance from a technician specialised in electrical installations.

## Charging cable for charging stations (AC)

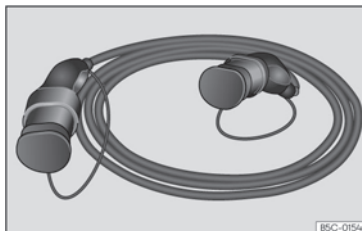

**Fig. 156** In the luggage compartment: charging cable for charging stations (depending on the equipment).

The maximum charging current is 16 or 32 amps, depending on the vehicle's features and the charging cable that is supplied » ⚠

### ⚠ WARNING

Charging the high-voltage battery with an inappropriate charging cable could cause short circuits, serious injuries and fatal electrical shocks.

### ⚠ WARNING

The charging cable should not be used as an extension lead. The charging process could be affected. »

**ⓘ CAUTION**

Follow the manufacturer's instructions and indications when using the charging station.

**i Note**

Charging with a 16 A charging cable is not possible in some charging stations that support 32 A. This depends on the features of the charging station.

- Before charging the vehicle, find out about the available charging technology.

**Charging cable for power sockets**

**Fig. 157** Charging cable for electrical sockets

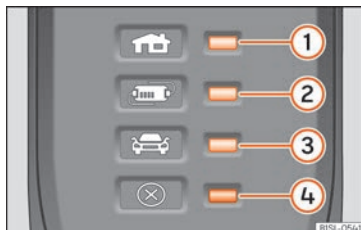

**Fig. 158** On the charging cable for power sockets: protection device.

Key to the »»» **Fig. 158**:

- ① Control lamp of the power connector
- ② Control lamp of the protection device
- ③ Control lamp of the vehicle
- ④ Failure warning lamp

The supplied charging cable is for charging the high-voltage battery using alternating voltage [AC] from a power socket »» page 164.

Also bear in mind the safety information and indications on the charging cable label.

**Protection device**

Due to the electronic protection device »» **Fig. 158**, the charging connector does not receive current until it is plugged into the charging socket of the vehicle. When the charging cable is plugged into the power

socket, the protection device automatically performs a self-check. The control and warning lamps then briefly light up and turn off. Then the current operating status is displayed.

**Operating displays**

The control lamps that indicate the operation turn on or flash green.

Display »»» Fig. 158	Meaning
① on	Charging cable connected to the electrical network.
①, ② on, ③ flashes <sup>a)</sup>	High-voltage battery charging.
①, ② and ③ on	Charging process complete. The high-voltage battery is charged.

<sup>a)</sup> The available supply voltage depends on each country.

**Display in the event of the charging cable heating**

The charging cable is fitted with a temperature supervision system. The temperature supervision is activated if the charging cable is too hot due to, for example, overheating in the luggage compartment where it is stored or exposure to intense solar radiation.

If it is still possible to charge, in addition to the operating display flashing, the red warning lamp »» Fig. 158 will also appear. The charging current is automatically **reduced**. The charging current will increase again when the charging cable has cooled down sufficiently.

In the event of the charging process having **paused** due to the protection device, the operating display will turn off and a green warning lamp will flash. The red warning lamp will flash. Unplug the charging cable and let it cool down. If the fault occurs again, consult a specialised workshop.

### Limiting the charging current

The charging cable limits the charging current based in the existing power supply. Depending on the power socket of the country in question, the maximum charging current may be 6, 8 or 10 A.

The management of the battery charge enables to select a lower or maximum charging current.

### Failure indications

If the warning lamp ④ flashes or is red without the operating display ①, ② or ③ remaining on, this indicates there is a failure. The charging process will pause or cancel. Check the failure display and consult a specialised workshop if necessary.

Display »» Fig. 158	Meaning
① flashes, ④ on or flashing	Failure in the power supply.
② flashes, ④ on or flashing	Failure in the protection device.
③ flashes, ④ on or flashing	Failure in the vehicle.

### ⓘ CAUTION

Seek information regarding the appropriate charging cable and the maximum permitted charging current before travelling abroad. If possible, use the charging cable supplied in the country in question.

### ⓘ Note

The charging cables supplied in countries other than Norway are often not appropriate for charging from power sockets. Norwegian charging cables are not fitted with control lamp ① because they use a different electrical network.

### ⓘ Note

If there is another consumer connected simultaneously to the electrical network during the charging process or if the vehicle is in the vicinity of high-voltage cables, it is possible that the charge cannot be per-

formed from a power socket. Simultaneous connections to the electrical network:

- Connection of a charger for the 12-volt starter battery.
- Contact with a working equipment connected to the electrical network, i.e. an elevating platform.

## Verification and replacement

### Engine compartment

#### Safety warnings for performing works in the engine compartment

The engine compartment of the vehicle is a dangerous area. You should only perform works in the engine compartment if you have good knowledge of the necessary operations and the general safety measures, and if you have adequate tools, means and operating fluids. Works performed inadequately, could lead to serious injuries »» » ⚠. In this case, seek a specialised workshop to perform all the works. SEAT recommends visiting a SEAT dealership for this.

Before performing any work in the engine compartment, always park the vehicle on level and firm ground, taking all necessary safety precautions.

Only specialised workshops qualified according to the SEAT guidelines are authorised to perform works on the high-voltage system »» » ⚠.

#### ⚠ WARNING

The voltage of the high-voltage system and of the high-voltage battery could be fatal!

Touching damaged high-voltage cables (orange colour) and the high-voltage battery could cause an electrical shock with deadly consequences. The high-voltage system may be active even with the ignition disconnected!

- Never perform any type of work on the high-voltage system, on the orange coloured high-voltage cables, on the high-voltage components or on the high-voltage battery. Only specialised workshops that are qualified and approved for performing works on high-voltage systems are authorised to perform works on the high-voltage network.
- Never modify, damage or remove the orange coloured high-voltage cables, the high-voltage components or the high-voltage battery, or uncouple them from the high-voltage system.
- To perform works close to high-voltage components and cables, as well as on the high-voltage battery, which require the use of sharp tools, which may deform or release shavings, or sources of heat, such as works involving welding, soldering, use of hot air or thermal gluing, it is essential you first ensure the system is not powered. The voltage to the high-voltage battery cannot be disconnected. Only duly qualified and trained technicians are authorised to leave the high-voltage system without power.
- When there is a fault in the high-voltage system, the engine may automatically de-

activate and the relevant display may appear on the instrument panel. In this case, the engine will remain deactivated until duly qualified and trained technicians resolve the fault.

- When performing works on the high-voltage system, especially on the orange coloured high-voltage cables, on the high-voltage components or on the high-voltage battery, ensure you bear in mind the SEAT guidelines.

#### ⚠ WARNING

If works are performed on the high-voltage system and on the high-voltage components in an inappropriate manner, this may lead to faults in the operation, accidents and injuries.

- Only duly qualified and trained technicians are authorised to perform works on the high-voltage system and on any other systems on which these may have indirect influence.

#### ⚠ WARNING

Any accidental movement of the vehicle during maintenance work could cause serious injuries.

- Never perform works underneath the vehicle without having first immobilised it to prevent it from moving. When performing works underneath the vehicle with the wheels on the ground, the vehicle must be



on level ground, the wheels must be locked and, where appropriate, the vehicle key must be removed from the ignition lock.

- If work must be performed underneath the vehicle, take the extra precaution of supporting it safely using suitable assembly support. The jack is not suitable for this purpose and may not withstand, which could lead to serious injuries.

### WARNING

The engine compartment of any vehicle is a dangerous area in which serious injuries can be caused!

- When performing any type of work, always ensure you are extremely cautious, and bear in mind the general safety measures. Never put yourself at risk.
- Never perform works in the engine compartment if you do not have solid knowledge of the necessary operations. If you are unsure of what needs to be done, seek a specialised workshop to perform the works. Works performed inadequately, could lead to serious injuries.
- Never open the bonnet if the engine compartment is discharging steam or engine coolant. Steam or hot coolant can cause severe burns. Always wait until you stop hearing or seeing the steam or coolant discharging from the engine compartment.

- Before opening the bonnet, always wait until the electric drive system and the high-voltage components have cooled down.

- If you touch hot parts of the electric drive system, you may suffer skin burns.

- When the electric drive system has cooled down, before opening the bonnet bear in mind the following:

- Engage the handbrake, tighten it and place the selector lever in position P or the gear lever in neutral.

- Switch off the ignition, remove the key from the ignition lock and store it in a safe place at a safe distance from the vehicle to prevent the ignition from turning on by mistake or power the electrical system.

- Always keep children away from the engine compartment and never leave them unsupervised.

- When the electric drive system is hot, its cooling system is under pressure. Never open the coolant expansion tank cap when the drive system is hot. Otherwise the coolant could splash and cause severe burn and other injuries.

- Turn the coolant expansion tank cap slowly and very carefully anticlockwise while pressing it down slightly.

- Always protect your face, hands and arms from the hot coolant and steam with a large thick cloth.

- When refilling operating fluids, ensure they do not spill onto the components of the engine or onto the exhaust system. These liquids could cause a fire.

### WARNING

The electrical system is under high voltage and can cause electrical shocks, burns, serious injuries and even death!

- Never short circuit the electrical system. The 12-volt battery may explode.

- To reduce the risk of suffering a fatal electrical shock and serious injuries, while the drive system is connected or is connecting, never touch the high-voltage components, the high-voltage battery or the high-voltage system, especially the orange coloured high-voltage cables.

### WARNING

The engine compartment contains rotating parts that could cause serious injuries.

- Never insert your hand in the radiator fan or around that area. All the rotor blades can cause serious injuries. The fan activates depending on the temperature and can switch on automatically, even with the ignition disconnected and with the key removed from the ignition lock.

- If you have to perform works during the disconnection of the drive system or which it connected, bear in mind that the rotating



parts (i.e. the radiator fan) represent a fatal hazard. Always act with extreme care.

- Always ensure that no part of your body, or any jewellery or tie, loose clothing, loose long hair can become trapped in the rotating parts of the engine. Before performing works in the engine compartment, remove any jewellery or tie you may be wearing, tie up your hair if it is long and gather any loose clothing to prevent them from becoming tangled with the engine parts.
- Never step on the accelerator pedal without paying attention, always do so with extreme care. The vehicle could move, even if the electronic parking brake is activated.
- Never leave any object in the engine compartment, i.e. cloths or tools. These objects could cause functional failures, damage to the electric drive system and even a fire.

### WARNING

If additional insulating elements (i.e. blankets) are placed in the engine compartment, this could prevent the electric drive system from operating correctly, could cause a fire and lead to serious injuries.

- Never cover the electric drive system with blankets or other insulating materials.

### WARNING

The operating fluids and some materials of the engine compartment are highly flammable and could cause a fire and serious injuries! · Never smoke in the vicinity of the engine compartment.

- Never perform works close to unprotected flames or sparks.
- Never spill operating fluids on the electric drive system. The liquids could ignite upon coming into contact with the hot parts of the electric drive system and cause injuries.
- When you must perform works on the on-board 12-volt electrical system, bear in mind the following:
  - Always disconnect the 12-volt battery. Ensure the vehicle is unlocked when disconnecting the 12-volt battery, otherwise the anti-theft alarm will trigger.
  - Never perform works in the vicinity of heating elements, water boilers or unprotected flames.
- Always have a fire extinguisher close-by, ensuring it is operational and had been checked.

### CAUTION

When refilling or changing the operating fluids, ensure you pour the correct fluids into their corresponding filler caps. Using the wrong operating fluids could cause severe

functional failures and damage to the engine.

### CAUTION

After an accident or having hit an obstacle with the vehicle underside, the high-voltage battery must be checked by duly qualified and trained technicians.

### For the sake of the environment

Operating fluids that overflow from the vehicle contaminate the environment. Therefore, check underneath the vehicle on a regular basis. If there are marks left by operating fluids on the ground, consult a specialised workshop and request the vehicle be checked. If any operating fluid leaks out, dispose of it in the correct manner.

## Working in the engine compartment

Before performing works in the engine compartment, always perform the following operations in the order indicated »» :

- Place the vehicle on level and firm ground, taking all necessary safety precautions.
- Press the brake pedal and keep it pressed until you disconnect the drive system.
- Engage the handbrake and tighten it.

- Place the selector lever to the P  
»» page 140 position.
- Disconnect the drive system »» page 137.
- Remove the vehicle key outside the vehicle and keep it at a distance to prevent the drive system from connecting by mistake and powering the electrical system »» page 138.
- Wait for the electric drive system to cool down.
- Keep children and other people away from the engine compartment.
- Ensure the vehicle cannot go into motion unexpectedly.

### **⚠ WARNING**

For your own safety, do not ignore this important check list, otherwise this could cause accidents and serious injuries.

- Always follow the indications on the check list and always bear in mind the general safety measures.

### Opening and closing the bonnet

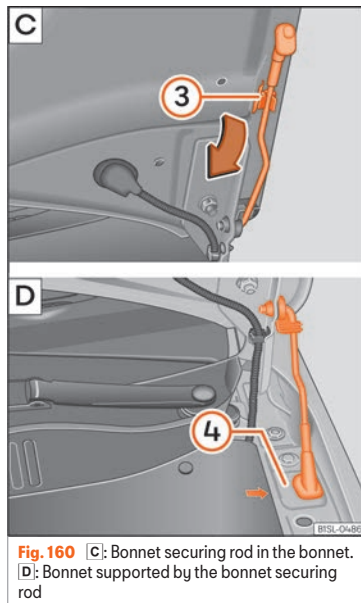
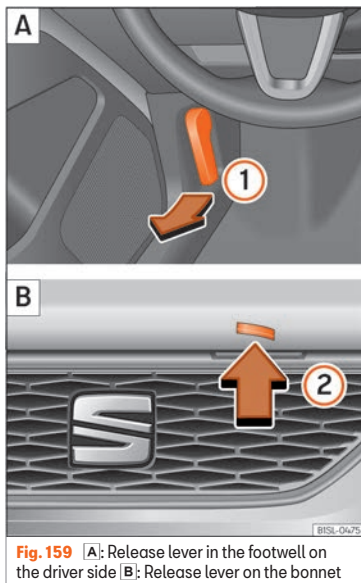

### Opening the bonnet

The bonnet is released from inside the vehicle.

Before opening the bonnet, make sure that the windscreen wiper arms are in place against the windscreen. »

- Open the door and pull the lever under the dashboard »» Fig. 159 ①.
- Lift the bonnet up slightly while pressing the release lever »» Fig. 159 ② in the direction of the arrow to completely open the bonnet.
- Take out the bonnet support rod from its clip in the direction of the arrow »» Fig. 160 ③ and place it in the corresponding open position ④ [arrow].

### Closing the bonnet

- Slightly lift the bonnet.
- Release the bonnet stay and replace it in its support.
- At a height of approximately 30 cm let it fall so it locks.

If the bonnet does not close, do not press downwards. Open it again and let it fall as mentioned above.

### WARNING

**If the bonnet is not properly closed, it could open unexpectedly while in motion and impede forward visibility. This could cause accidents and lead to serious injuries.**

- After closing the bonnet, ensure that the lock is duly engaged in the lock carrier. The bonnet must be at the same level as the adjacent parts of the bodywork.

- If while in motion you notice the bonnet is not properly closed, stop the vehicle immediately and close the bonnet.
- Open and close the bonnet only when there is nobody in its path.

### CAUTION

- To avoid damage to the bonnet and to the wiper arms, open the bonnet only when the wiper is disconnected and the wiper arms are positioned on the windscreen.
- Before starting to move, always place the wiper arms on the windscreen.

## Cooling system

### Control lamp

#### Flashes red

Excessive engine coolant temperature.

 **Stop the vehicle!** Stop the vehicle safely as soon as possible. Disconnect the drive system and allow to cool until the lamp switches off. If the lamp does not switch off once the drive system has cooled down, seek specialist assistance.

Insufficient engine coolant level.

 **Stop the vehicle!** Check the coolant level once the drive system has cooled down and, if it is low, refill with engine coolant »» page 179.



**Flashing red next to the display -- - on the instrument panel.**

Engine coolant system faulty.

 **Stop the vehicle!** Seek specialist assistance.

Several control and warning lamps light up for a few seconds when the ignition is switched on while the function is verified. They will switch off after a few seconds.

### WARNING

**Observe the safety warnings »»  in Control and warning lamps on page 66.**

### Coolant specifications

The engine cooling system is supplied from the factory with a specially treated mixture of water and at least 40 % of the additive **G12evo** (TL-VW 774 J), purple. This mixture gives the necessary frost protection down to -25°C (-13°F) and protects the light alloy parts of the engine cooling system against corrosion. It also prevents scaling and considerably raises the boiling point of the coolant.

To protect the cooling system, the percentage of additive must always be at least 40 %, even in warm climates where anti-freeze protection is not required.

If for weather reasons further protection is necessary, the proportion of additive may be increased, but only up to 60 %; otherwise anti-freeze protection will diminish and this will worsen cooling.

When the coolant is topped up, use a mixture of **distilled water** and at least 40 % of the additive **G12evo** for optimal protection against corrosion. Mixing **G12evo** with G13 (TL-VW 774 J), G12 plus-plus (TL-VW 774 G), G12 plus (TL-VW 774 F), G12 (red) or G11 (green blue) engine coolants decreases protection again corrosion and should be avoided.

### ⚠ WARNING

If there is not enough anti-freeze in the coolant system, the engine may fail leading to serious damage.

- Ensure that the percentage of additive is correct for the lowest expected ambient temperature in the zone in which the vehicle is to be used.
- When the outside temperature is very low, the coolant could freeze and the vehicle would be immobilised.

### ⓘ CAUTION

The original additives should never be mixed with coolants which are not approved by SEAT.

- If the fluid in the expansion tank is not purple but is, for example, brown, this indicates that the G12evo additive has been mixed with an inadequate coolant. The coolant must be changed as soon as possible if this is the case!

### ♻ For the sake of the environment

Coolants and additives can contaminate the environment. If any fluids are spilled, they should be collected and correctly disposed of, with respect to the environment.

## Refilling coolant



**Fig. 161** In the engine compartment: marking on coolant expansion tank.



**Fig. 162** Engine compartment: coolant expansion tank cap.

The coolant tank is located in the engine compartment » page 174.

Top up coolant when the level is below the **MIN** (minimum) mark.

### Checking coolant level

- Park the vehicle in a horizontal position.
- Switch the ignition off.
- Read off the coolant level on coolant expansion tank. When the drive system is cold, the coolant level should be between the marks » **Fig. 161**. With the drive system hot, the level may be slightly above the top mark.

### Topping up coolant

- Allow the drive system to cool.

»

- Unscrew the cap slowly and carefully while pressing downwards on the cap. » » ⚠.
- Only refill the coolant if the coolant expansion tank still contains coolant; otherwise you could **damage the drive system**. If there is no coolant in the expansion tank, do not continue driving. You should obtain professional assistance » » ❶.
- If there is still some coolant in the expansion tank, top up to the upper mark.
- Top up with coolant until the level becomes stable.
- Screw the cap back on correctly.

If there is a coolant leak, take the vehicle specialised workshop to have the cooling system examined.

### ⚠ WARNING

- The cooling system is under pressure. Do not open the coolant expansion tank cap when the drive system is hot: risk of burns!
- Store the antifreeze in its original container and keep it out of reach of children.
- If working inside the engine compartment, remember that, even when the ignition is switched off, the radiator fan may start up automatically, and therefore there is a risk of injury.

### ❶ CAUTION

If you run out of coolant in the expansion tank, park the vehicle in a safe place and do not continue driving. Obtain technical assistance.

## Brake fluid

### Check and refill the brake fluid



**Fig. 163** Engine compartment: brake fluid reservoir cap.

The brake fluid reservoir is located in the engine compartment.

### Checking the brake fluid level

The brake fluid level must be between the **MIN** and **MAX** markings.

However, if the brake fluid level goes down noticeably in a short time, or drops below the **MIN** mark, there may be a leak in the brake system. Seek specialist assistance. A warning light on the instrument panel display monitors the brake fluid level » » page 65.

### Changing brake fluid

We recommend that you have the brake fluid changed by a Technical Service.

### ⚠ WARNING

If the brake fluid level is low or unsuitable/old brake fluid is used, the brake system may fail or braking power may be reduced.

- Check the brake system and the brake fluid level regularly!
- When the brake fluid is used and brakes are subjected to extreme braking forces, bubbles of vapour form in the brake system. These bubbles can significantly reduce braking power, notably increasing braking distance, and could result in the total failure of the brake system.
- Be sure to always use the correct brake fluid. Only use brake fluid that expressly meets the VW 501 14 standard.
- You can buy VW 501 14 standard brake fluid in a SEAT dealership or a SEAT Official Service. If none is available, use only high-quality brake fluid that meets DIN ISO 4925

CLASS 4 standards, or USA Standards FMVSS 116 DOT 4.

- The replacement brake fluid must be new.
- Brake fluid should be stored in the closed original container in a safe place out of reach of children. Risk of poisoning!

#### ⓘ CAUTION

Brake fluid should not come into contact with the vehicle paintwork, as it is abrasive.

#### ♻️ For the sake of the environment

Brake fluid is an environmental pollutant. Collect any spilt service fluids and allow a professional to dispose of them.

## Windscreen washer reservoir

### Checking the level of the window washer tank and refilling it



**Fig. 164** In the engine compartment: window washer tank cap.

The windscreen washer reservoir is in the engine compartment.

Check the water level in the windscreen washer reservoir regularly and top up as required.

The window washer tank contains liquid detergent for the windscreen and rear window.

- Open the bonnet **▲** » page 176.
- The window washer tank is marked with the **♻️** symbol on the cap.
- Check there is enough windscreen water in the reservoir.

Plain water is not enough to clean the windscreen and headlights. We recommend that you always add a product to the windscreen washer fluid.

#### Recommended windscreen wipers

- For the hottest seasons we recommend summer G 052 184 A1 for clear glass. Proportions of the mixture in the washer fluid tank: 1:100 (1 part concentrate per 100 parts water).
- All year round, G 052 164 A2 for clear glass. Approximate proportion of the winter mixture, up to -18°C (0°F): 1:2 (1 part concentrate per 2 parts water); otherwise, a 1:4 proportion of mixture in the washer fluid tank.

The capacity of the window washer tank can be found in » page 211.

#### ⓘ CAUTION

If the water from the windscreen washer does not contain enough anti-freeze, it may freeze on the windscreen and rear window, reducing forward and rear visibility.

- In winter, ensure the windscreen washer contains enough anti-freeze.
- In cold conditions, you should not use the windscreen wiper system unless you have warmed the windscreen with the ventilation system. The antifreeze could freeze on the windscreen and reduce visibility. »

### ⓘ CAUTION

Never mix an unsuitable antifreeze or other similar additives with the windscreen washer water. A greasy layer may be formed on the windscreen which will impair visibility.

- Use clean water with a window cleaner recommended by SEAT.
- If necessary, add a suitable antifreeze to the water in the reservoir.

### ⓘ CAUTION

Do not mix cleaning products recommended by SEAT with other products. This could lead to flocculation and may block the windscreen washer jets.

- When topping up service fluids, make absolutely certain that you fill the fluids into the correct reservoirs. Using the wrong fluids could cause serious malfunctions and engine damage!
- Not having windscreen wiper fluid reduces visibility through the windscreen, and leads to loss of visibility in headlights in models with headlight washer.

## 12-volt battery

### Introduction

The 12-volt battery is part of the electrical system and in the event of a high-voltage

system failure it supplies power to safety-critical vehicle systems. The 12-volt battery is checked as part of inspection work and replaced if necessary.

You may only work on the electrical system if you are familiar with the necessary procedures and general safety measures, and if you have the correct fluids and operating equipment, as well as the right tools. Work done incorrectly can cause serious injuries »» ⚠ in Location of the 12 volt battery on page 182. Get a qualified establishment to do all work. Seat recommends Seat dealerships for this purpose.

You will find information about any warning and control lamps that may light up in the “Problem solving” section at the end of the chapter »» page 185.

### Location of the 12 volt battery

The 12 volt battery is located in the engine compartment.

### Explanation of the warning indications on the 12-volt battery



Wear eye protection.



Battery acid is extremely corrosive. Wear protective gloves and eye protection. Rinse any splashes of electrolyte with plenty of water.



Fires, sparks, open flames and smoking are prohibited.



The 12-volt battery should only be charged in a well-ventilated zone. Risk of explosion!



Keep children away from acid and the 12-volt battery.



Always follow the instruction manual.

### ⚠ WARNING

Work on the 12 volt battery and electrical system can cause severe burns, fires, and electric shock. Before doing any work, the following warning instructions must be read and followed, and the following precautions must be taken:

- Before doing any work on the 12-volt battery, switch off the ignition and all electrical consumers and disconnect the negative cable from the 12-volt battery.
- Keep children away from electrolyte and the 12-volt battery at all times.
- Always wear protective goggles and gloves.
- Electrolyte is highly corrosive. It can cause skin burns and blindness. When handling the 12-volt battery you must particularly protect your hands, arms and face from splashes of electrolyte.
- Never smoke or work close to naked flames or sparks.



- Avoid generating sparks when handling cables and electronic devices, or as a result of an electrostatic discharge.
- Never short the battery terminals.
- Never use a damaged 12 volt battery. It could explode. A damaged 12 volt battery should be replaced immediately.
- Never use a frozen 12 volt battery. A discharged 12 volt battery may freeze at a temperature of just 0 °C (+32 °F). A frozen 12 volt battery should be replaced immediately.

### ⓘ CAUTION

The 12 volt battery should not be exposed to direct sunlight for a long time.

- Ultraviolet rays could damage the battery case.

### ⓘ CAUTION

If it is not going to be used for a long period of time, the 12 volt battery should be protected from frost.

- The 12 volt battery can freeze and become unusable.

### ⓘ Note

When turning on the drive system with a drained or newly replaced 12-volt battery, or after a jump start, it is possible that some system settings (time, date, personal

comfort options and programs) may be lost or deleted. Check and correct these settings once the 12-volt battery is sufficiently charged.

### Check the 12-volt battery electrolyte level

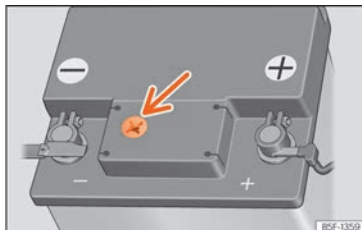

**Fig. 165** Sight glass on the top of the 12 volt battery (schematic representation).

The electrolyte level of the 12 volt battery should be checked periodically in cases of high mileage, in countries with hot climates and if an old 12-volt battery is used. Otherwise, the 12-volt battery is maintenance-free.

### Preparations

- Prepare the vehicle for work in the engine compartment »» page 176
- Open the bonnet »» page 177

### Check the electrolyte level (12-volt batteries with a sight glass)

- Ensure sufficient lighting to clearly identify the colour indication displayed in the circular sight glass located at the top of the 12-volt battery (arrow) »» Fig. 165. Never use naked flames or objects that burn without a flame as lighting.
- The colour displayed in the circular sight glass changes depending on the electrolyte level in the 12-volt battery.

There are two different colours:

*Yellow or colourless:* The electrolyte level of the 12-volt battery is too low. Go to a specialised workshop to have the battery checked and replaced if necessary.

*Black:* The electrolyte level of the 12-volt battery is correct.

### ⚠ WARNING

**Working on 12-volt batteries can cause severe burns, explosions and electric shock.**

- Always wear protective goggles and gloves.
- Electrolyte is highly corrosive. It can cause skin burns and blindness. When handling the 12-volt battery you must particularly protect your hands, arms and face from splashes of electrolyte. »»

- Never turn the 12-volt battery over. Electrolyte could leak out of the vents and cause burns.
- Never open a 12-volt battery.
- If the electrolyte splashes onto the skin or eyes, rinse the affected area with cold water for a few minutes. Then seek medical care immediately.
- Seek medical care immediately if you ingest the acid.

### Charging, replacing, disconnecting and connecting the 12-volt battery

If the 12-volt battery is suspected of being damaged or defective, have it checked by a qualified establishment.

#### Charging the 12-volt battery

The 12-volt battery must be charged at a qualified establishment, as the factory fitted 12-volt battery technology requires a voltage limited charge »» » ⚠. SEAT recommends visiting a SEAT dealership for this.

#### Replacing the 12-volt battery

The 12-volt battery is developed to suit its location and has special safety features. When a 12-volt battery needs to be replaced, before buying a new one you must ask a SEAT

dealership about electromagnetic compatibility, size and maintenance, power and safety requirements that the new battery must meet. The 12-volt battery's vent must always be on the side of the negative terminal and the vent on the positive terminal must always be closed.

A maintenance-free battery that meets the TL 825 06 and VW 7 50 73 standards must always be used. These standards must be dated October 2014 or later.

The 12-volt battery must always be replaced by a qualified establishment, as it is necessary to adjust the vehicle's electronic system as part of its replacement. Only a qualified establishment has the appropriate technology to make this adjustment correctly. SEAT recommends that the 12-volt battery be replaced by a SEAT dealer.

#### Disconnecting the 12-volt battery

If the 12-volt battery needs to be disconnected from the vehicle's electrical system, these steps should be followed:

- Switch off the ignition and all electrical consumers.
- Before disconnecting the battery, unlock the vehicle or theft alarm system will activate.
- First disconnect the negative cable and then the positive cable »» » ⚠.

#### Connecting the 12-volt battery

- Before reconnecting the 12-volt battery, disconnect all electrical consumers and the ignition.
- First reconnect the positive cable and then the negative one »» » ⚠.

After connecting the 12-volt battery and turning on the ignition, different indicator lights may come on. They will turn off when a short distance is driven at approximately 15-20 km/h. If the warning indicators remain lit, please visit a qualified establishment to have the vehicle checked.

If the 12-volt battery has been disconnected for a long time, it's possible that the next service appointment might not be displayed or calculated correctly. »» » page 63. Respect the maximum service intervals permitted »» » page 194.

#### Automatic disconnection of consumers

Thanks to the smart management of the on-board network, when the 12-volt battery is overcharged different measures are taken to prevent the 12-volt battery from discharging:

- If necessary, the power in the largest consumers is limited, or they are disconnected completely in an emergency.

However, on-board network management cannot always prevent the 12-volt battery

from discharging. For example, if the ignition is kept on for a long time with the engine stopped or if the parking or side light is left on for a long time.

### The 12-volt battery discharges

- if electrical consumers are used while the drive system is switched off.

#### WARNING

Incorrectly installing the 12-volt battery or using an inappropriate 12-volt battery can cause short circuits, fires and severe injuries.

- Maintenance-free and leak-protected 12-volt batteries must always be used, and they must have the same characteristics, specifications and dimensions as the factory-fitted 12-volt battery.

#### WARNING

A highly explosive gas mixture is generated during the charging process of the 12-volt battery.

- Only charge the 12-volt battery in a well-ventilated place.
- Never charge a frozen or thawed 12-volt battery. A discharged 12 volt battery may freeze at a temperature of just 0 °C (+32 °F).
- Any 12-volt battery that has frozen must be replaced.

- **Incorrectly connected connection cables can cause a short circuit. First connect the positive cable and then the negative one.**

#### CAUTION

Never connect power supply accessories, such as solar panels or battery chargers, to the 12-volt socket or cigarette lighter to charge the 12-volt battery. This could damage the vehicle's electrical system.

#### For the sake of the environment

- 12-volt batteries contain toxic substances such as sulphuric acid and lead. The 12 volt battery must be disposed of in accordance with current regulations.
- Electrolyte can contaminate the environment. Used vehicle fluids must be collected and disposed of properly.

### Troubleshooting

 The indicator lamp lights up red and this text message is displayed: **12 volt power supply interrupted.**

 **Stop the vehicle!** The vehicle should be stopped as soon as it is possible and safe to do so. The 12-volt battery does not charge while driving.

- Disconnect any unnecessary electrical consumers.
- Go to a qualified establishment to get the system checked.

The following text message is displayed:  
**Error: 12 volt power system.**

The connection between the on-board network and the 12-volt battery has been interrupted. If the drive system switches off in this situation, it should not be switched on again and the vehicle should be jump started **» page 45** or professional assistance should be sought.

- Go to a qualified establishment to get the system checked.

The following text message is displayed:  
**Error: Switching off the 12 volt battery.**

The 12-volt battery supervision system does not work.

- Go to a qualified establishment to get the system checked.

The following text message is displayed:  
**Error: 12-volt battery: Workshop.**

The 12 volt vehicle battery has almost reached the end of its useful life. **»**

- Go to a qualified establishment and request a check and, if necessary, the replacement of the 12-volt battery »» page 184.

**The following text message is displayed:  
Check the 12-volt battery!**

The connection between the on-board network and the 12-volt battery has been interrupted.

- Go to a qualified establishment to get the system checked.

**The following text message is displayed:  
12-volt battery low.**

Deficient charging of the 12-volt battery due to circumstances such as low temperatures.

- Go for a short drive to re-charge the 12-volt battery.

## Wheels

### Wheels and tyres

#### General notes

- When driving with **new tyres**, be especially careful during the first 500 km (300 miles).
- If you have to drive over a kerb or similar obstacle, drive very slowly and as near as possible at a right angle to the obstacle.
- Check from time to time if the tyres are damaged (punctures, cuts, cracks or dents). Remove any foreign objects embedded in the treads.
- Damaged wheels and tyres must be replaced immediately.
- Keep grease, oil and fuel off the tyres.
- Replace any missing valve caps as soon as possible.
- Mark the wheels before taking them off so that they rotate in the same direction when put back.
- When removed, the wheels or tyres should be stored in a cool, dry and preferably dark place.

#### Low profile tyres

Low profile tyres have a wider tread, a larger wheel diameter and a lower sidewall height. Therefore, its driving behaviour is more agile.

Low profile tyres may deteriorate more quickly than standard tyres, for instance due to strong knocks, potholes, manhole covers and kerbs. Correct tyre pressure is very important »» page 189.

To avoid damage to tyres and wheels, drive with special care when driving on roads in poor condition.

Visually check your wheels every 3000 km.

If the tyres or rims have received a heavy impact or have been damaged, have a specialised workshop check whether or not it is necessary to change the tyre.

Low profile tyres may deteriorate more quickly than standard tyres.

#### Concealed damage

Damage to tyres and rims is often not readily visible. If you notice unusual **vibration** or the car **pulling to one side**, this may indicate that one of the tyres is damaged. Reduce speed immediately if there is any reason to suspect that damage may have occurred. Inspect the tyres for damage. If no external damage is visible, drive slowly and carefully to the nearest specialised workshop and have the car inspected.

### Foreign objects inserted in the tyre

- Do not remove foreign bodies if they have penetrated through the tyre wall!
- If the vehicle comes with a tyre mobility system, where necessary seal the damaged tyre as shown in section »» page 35. Use a specialised workshop for repair or replacement. SEAT recommends visiting a SEAT dealership for this.

The sealant at the lower part of the tyre tread wraps around the foreign body and provisionally seals the tyre.

### Tyres with directional tread pattern

An arrow on the tyre sidewall indicates the direction of rotation on single drive tyres. Always note the direction of rotation indicated when mounting the wheel. This makes sure that optimal use is made of tyre properties in terms of aquaplaning, grip, excessive noise and wear.

### Subsequent fitting of accessories

If you wish to change or fit wheels, rims or wheel trims, we recommend that you consult with a SEAT Official Service centre for advice regarding current techniques.

### Speed symbols

The speed rating indicates the maximum speed permitted for the tyres.

P	max. 150 km/h [93 mph]
Q	max. 160 km/h [99 mph]
R	max. 170 km/h [106 mph]
S	max. 180 km/h [112 mph]
T	max. 190 km/h [118 mph]
U	max. 200 km/h [124 mph]
H	max. 210 km/h [130 mph]
V	max. 240 km/h [149 mph]

Some manufacturers use the letters "ZR" for tyres with a maximum authorised speed above 240 km/h [149 mph].

#### WARNING

- **New tyres do not have maximum grip during the first 500 km. Drive particularly carefully to avoid possible accidents.**
- **Never drive with damaged tyres. This may cause an accident.**
- **If you notice unusual vibrations or if the vehicle pulls to one side when driving, stop the vehicle immediately and check the tyres.**
- **Never use old tyres or those with an unknown history of use.**

### New wheels and tyres

It is best to have all wheels and tyres serviced by a specialised workshop. There they have the required knowledge, the special tools and the corresponding spare parts.

- Even winter tyres lose their grip on ice. If you have installed new tyres, drive the first 500 km carefully and at a moderate speed.
- All four wheels must be fitted with tyres of the same type, size [rolling circumference] and, if possible, tread pattern.
- When changing tyres, do not change just one; change at least two on the same axle.
- If you want to equip your vehicle with a combination tyres and rims that are different to those fitted in the factory, inform your specialised workshop before purchasing them »» 

The sizes of the rims and tyres approved for your vehicle are listed in the vehicle documentation (e.g. EC Certificate of Conformity or COC document<sup>1)</sup>). The vehicle documentation varies depending on the country of residence.

If the type of spare wheel is different from the normal wheels — e.g. in the case of winter tyres or particularly wide tyres — the spare wheel should only be used temporarily in the »

<sup>1)</sup> COC = certificate of conformity.

event of a puncture, and the vehicle should be driven with care. Refit the normal road wheel as soon as possible.

### Manufacturing date

The manufacturing date is also indicated on the tyre sidewall (or on the inside face of the wheel):

DOT ... 2218 ...

it means, for example, that the tyre was manufactured in the 22nd week of 2018.

### ⚠ WARNING

- Use only combinations of tyres and rims, as well as suitable wheel nuts, approved by SEAT. Otherwise the vehicle may be damaged, causing an accident.
- For technical reasons it is not possible to use wheels of other vehicles; in some cases not even wheels from the same vehicle model should be used.
- Always ensure that the tyres you have chosen have adequate clearance. When selecting replacement tyres, do not rely entirely on the nominal tyre size marked on the tyre, since the nominal tyre size can differ significantly depending on the manufacturer. Lack of clearance can damage the tyres or the vehicle and, as a result, endanger road safety. Risk of accident!
- Only use tyres that are over 6 years old in an emergency, and drive with due care.

- The fitting of tyres with run-flat properties is not permitted on your vehicle! Prohibited use can cause accidents or can damage your vehicle.
- If decorative hubcaps are subsequently fitted, make sure that they allow enough air in to cool the braking system. Risk of accident!

### ♻ For the sake of the environment

Old tyres must be disposed of according to the laws in the country concerned.

### i Note

- A SEAT Service Centre should be consulted to find out whether wheels or tyres of different sizes to those originally fitted by SEAT can be fitted, and to find out about the combinations allowed between the front axle (axle 1) and the rear axle (axle 2).
- Never mount used tyres if you are not sure of their "previous history".

## Tyre life

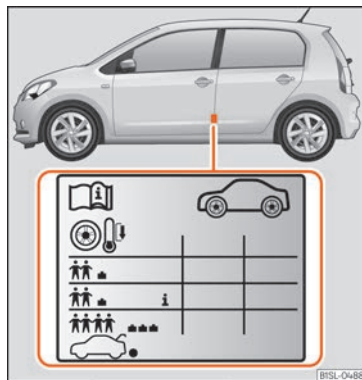

Fig. 166 Location of the tyre pressure sticker.

Correct inflation pressures and sensible driving habits will increase the useful life of your tyres.

- Check tyre pressure at least once a month, and also prior to any long trip.
- The tyre pressure should only be checked when the tyres are cold. Do not reduce the pressure of warm tyres.
- Adjust tyre pressure to the load being carried by the vehicle »» Fig. 166.
- In vehicles with a tyre pressure indicator, save the modified tyre pressure »» page 192.

- Avoid fast cornering and hard acceleration.
- Inspect the tyres for irregular wear from time to time.

### Tyre pressure

The tyre inflation pressures are listed on a sticker on the rear of the front left door frame »» Fig. 166.

Insufficient or excessive pressure greatly reduces the useful life of the tyres and adversely affects vehicle performance and ride. Correct inflation pressures are very important, especially at **high speeds**.

Depending on the vehicle, tyre pressure can be adjusted to medium load to improve driving comfort (tyre pressure **i**) »» Fig. 166). When driving with comfort tyre pressure, energy consumption may increase slightly.

The tyre pressure must be adjusted according to the load the vehicle is carrying. If the vehicle is going to carry the maximum load, the tyre pressure should be increased to the maximum value indicated on the sticker »» Fig. 166.

Do not forget the spare wheel when checking the tyre pressures: Keep this spare wheel inflated to the highest pressure required for the road wheels.

In the case of a minimised temporary spare wheel (125/70 R16 or 125/70 R18), inflate to a

pressure of 4.2 bar as indicated on the tyre pressure label »» Fig. 166.

### Driving style

Fast cornering, heavy acceleration and hard braking (squealing tyres) all increase tyre wear.

### Wheel balance

The wheels on new vehicles are balanced. However, certain circumstances may lead to imbalance (run-out), which is detected as vibrations in the steering wheel.

Unbalanced wheels should be rebalanced, as they otherwise cause excessive wear on steering, suspension and tyres. A wheel must also be rebalanced when a new tyre is fitted or if a tyre is repaired.

### Incorrect wheel alignment

Incorrect running gear alignment causes excessive tyre wear, impairing the safety of the vehicle. If you notice excessive tyre wear, you should check wheel alignment at a SEAT Official Service.

### WARNING

**Unsuitable handling of the wheels and tyres may lead to sudden tyre pressure losses, to tread separation or even to a blow-out.**

- The driver is responsible for ensuring that all of the vehicle tyres are correctly inflated to the right pressure. The recommended tyre pressure is indicated on the label »» Fig. 166.
- Check tyre pressures regularly and ensure they are maintained at the pressures indicated. Tyre pressure that is too low could cause overheating, resulting in tread detachment or even burst tyres.
- When the tyres are cold, tyre pressure should be that indicated on the label »» Fig. 166.
- Regularly check the cold inflation pressure of the tyres. If necessary, change the tyre pressure of the vehicle tyres while they are cold.
- Regularly check your tyres for damage and wear.
- Never exceed the maximum permitted speed or loads specified for the type of tyre fitted on your vehicle.

### For the sake of the environment

Insufficient tyre pressure increases energy consumption.

## Tread wear indicators



**Fig. 167** Tyre profile: tread wear indicators.

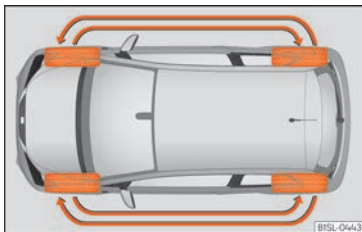

**Fig. 168** Interchanging tyres.

Wear indicators around 1.6 mm high can be found on the base of the original tyre treads, ordered at regular intervals and running across the tread » **Fig. 167**. The letters "TWI"

or triangles on the sidewall of the tyre mark the position of the wear indicators.

The minimum permitted profile depth <sup>1)</sup> have been reached when the tyres have worn down to the wear indicators. Replace the tyres with new ones » **⚠**.

## Changing wheels around

To ensure that the wear is equal on all tyres the wheels should be changed round from time to time according to the system » **Fig. 168**. The useful life of all the tyres will then be about the same time.

### **⚠ WARNING**

**The tyres must be replaced at the latest when the tread is worn down to the tread wear indicators. Failure to follow this instruction could result in an accident.**

- Particularly in difficult driving conditions such as wet or icy roads. It is important that the tyre tread be as deep as possible and be approximately the same on the tyres of both the front and the rear axles.
- The scant driving safety due to insufficient tread depth is particularly evident in vehicle handling, when there is a risk of "aquaplaning" in deep puddles of water

**and when driving through corners, and braking is also adversely affected.**

- **The speed has to be adapted accordingly, otherwise there is a risk of losing control over the vehicle.**

## Wheel nuts

The **wheel bolts** are matched to the rims. When installing different wheels (for instance alloy wheels or wheels with winter tyres) it is important to use the correct wheel bolts with the right length and correctly shaped bolt heads. This ensures that wheels are fitted securely and that the brake system functions correctly.

The wheel bolts must be clean and turn easily.

A special adapter is required to turn the anti-theft wheel bolts\* » **page 39**.

### **⚠ WARNING**

**Wheel nuts should never be greased or oiled.**

- **Use only wheel bolts which belong to the wheel.**

<sup>1)</sup> Follow the regulations of the country you are driving in.



- If the prescribed torque of the wheel bolts is too low, they could loosen whilst the vehicle is in motion. Risk of accident! If the tightening torque is too high, the wheel bolts and threads can be damaged.

### ⓘ CAUTION

See » page 42 to find out the recommended tightening torque for wheel nuts for steel and alloy rims.

## Winter tyres

- Winter tyres must be fitted **on all four** wheels.
- Only use winter tyres that are approved for your vehicle.
- Please note that the maximum permissible speed for winter tyres may be lower than for summer tyres.
- Also note that winter tyres are no longer effective when the **tread** is worn down.
- After fitting the wheels you must always check the tyre pressures. When doing so, take into account the correct tyre pressures listed on the rear of the front left door frame » page 188.

In winter road conditions winter tyres will considerably improve vehicle handling. The design of summer tyres (width, rubber compound, tread pattern) gives less grip on ice and snow. This applies particularly to vehicles equipped with **wide section tyres** or with **high speed tyres** (code letters H, V or Y on the sidewall).

Only use winter tyres of the correct type approved for your vehicle. The sizes of these tyres are specified in the vehicle's documents (e.g. EC Certificate of Conformity or COC<sup>1)</sup>). The vehicle documentation varies depending on the country of residence.

Winter tyres lose a great deal of their properties when the **tread** is worn down to a depth of 4 mm.

The performance of winter tyres is also severely impaired by **ageing**, even if the tread is still much deeper than 4 mm.

A code letter indicating the speed limit is stamped on all winter tyres » page 187.

Vehicles capable of exceeding these speeds must have an appropriate **sticker** attached so that it is visible to the driver. Suitable stickers are available from the SEAT Official Service and specialised workshop. Please note the regulations to this effect in your country.

"All-weather" tyres can also be used instead of winter tyres.

### Using winter tyres with V-rating

Please note that the generally applicable 240 km/h (149 mph) speed for winter tyres with the letter V is subject to **technical restrictions; the maximum permissible speed for your vehicle may be significantly lower**. The maximum speed limit for these tyres depends directly on the maximum axle weights for your car and on the listed weight rating of the tyres being used.

It is best to contact a SEAT Official Service to check the maximum speed which is permissible for the V-rated tyres fitted on your car on the basis of this information.

### ⚠ WARNING

**Exceeding the maximum speed permitted for the winter tyres fitted on your car can cause tyre failure, resulting in a loss of control of the vehicle – risk of accident.**

### 🌿 For the sake of the environment

**When winter is over, change back to summer tyres at an appropriate moment. In temperatures above +7°C (+45°F), performance will be improved if summer tyres are** »

<sup>1)</sup> COC = certificate of conformity.

used. Rolling noise, wear and energy consumption will all be reduced.

### Snow chains

Snow chains should **only be used on the front wheels**.

- Check that they are correctly seated after driving for a few yards; correct the position if necessary, in accordance with the manufacturer's fitting instructions.
- Keep your speed below 50 km/h (30 mph).

Snow chains will improve *braking ability* as well as *traction* in winter conditions.

For technical reasons snow chains may only be used with the following wheel rim/tyre combination.

165/70 R14	Chains with links of maximum 15 mm
175/65 R14	

Remove any central wheel trims and the rim ring before fitting snow chains.

### ⚠ WARNING

**The use of unsuitable or incorrectly fitted chains could lead to serious accidents and damage.**

- Always the appropriate snow chains.

- Observe the fitting instructions provided by the snow chain manufacturer.
- Never exceed the maximum permitted speeds when driving with snow chains.

### ⓘ CAUTION

- Remove the snow chains to drive on roads without snow. Otherwise they will impair vehicle handling, damage the tyres and wear out very quickly.
- Wheel rims may be damaged or scratched if the chains come into direct contact with them. SEAT recommends the use of covered snow chains.

## Tyre pressure monitor system\*

### Control lamp

#### ⓘ It lights up

The tyre pressure of a wheel is much lower than the value set by the driver » ⚠ in Tyre pressure monitor system\* on page 193.

Several control and warning lamps light up for a few seconds when the ignition is switched on while the function is verified. They will switch off after a few seconds.

### ⚠ WARNING

Observe the safety warnings » ⚠ in Control and warning lamps on page 66.

### Tyre pressure monitor system\*



**Fig. 169** In the glove box: tyre pressure loss indicator button.

The tyre pressure loss indicator compares the revolutions and thus the wheel diameter of each wheel using the ESC. If the wheel diameter of a wheel changes, the control indicator of the tyres informs of this fact ⓘ. The wheel diameter changes when:

- Tyre pressure is insufficient.
- The tyre structure is damaged.
- The vehicle is unbalanced because of a load.

- The wheels of one axle are under more pressure (for example, driving with a trailer or on steep slopes).
- The vehicle is fitted with snow chains.
- The temporary spare wheel is fitted.
- The wheel on one axle is changed.

### Tyre pressure setting

On adjusting tyre pressure or changing one or more wheels, the **»» Fig. 169** button must be kept pressed down, with the ignition on, until an acoustic signal is heard.

If the wheels are under excessive load (for example, driving with a trailer or heavy load), the tyre pressure must be increased to the recommended value for a full load (see the sticker **»» Fig. 166**). If the tyre monitor system button is pressed down, the new tyre pressures are confirmed.

### WARNING

When the tyres are inflated at different pressures or at a pressure that is too low then a tyre may be damaged resulting in a loss of control of the vehicle and a serious or fatal accident.

- If the lamp  lights up, reduce speed immediately and avoid any sudden turning or braking manoeuvre. Stop when possible, and check the tyre pressure and status.

- The tyre monitoring system can only operate correctly if all of the tyres are inflated to the correct pressure when cold.
- If a tyre has not been punctured and it does not have to be changed immediately, drive to the nearest specialised workshop at a moderate speed and have the tyre checked and inflated to the correct pressure.

### Note

- Driving for the first time with new tyres at a high speed can cause them to slightly expand, which could then produce an air pressure warning.
- Do not only rely on the tyre monitoring system. Regularly check your tyres to ensure that the tyre pressure is correct and that the tyres are not damaged due to puncture, cuts, tears and impacts/dents. Remove objects from the tyres only when they have not pierced the tyres.
- The tyre monitoring indicator does not function when there is a fault in the ESC or ABS **»» page 153**.
- If the battery is disconnected, the yellow warning lamp  lights up after turning the ignition on. This should turn off after a brief journey.

# Maintenance

## SEAT Maintenance Programme

### Service intervals

#### Service work and the Digital Maintenance Plan

##### Log of services performed (“Digital Maintenance Plan”)

The SEAT dealership or a specialised workshop records Service receipts in a central system. Thanks to this comprehensive documentation of the service history, it is possible to reproduce the services performed any time. SEAT recommends requesting a Service receipt after every service carried out containing all the services carried out on the system.

Whenever there is a new service the receipt is replaced with a current one.

**The Digital Maintenance Plan is not available in some markets. In this case, your SEAT dealer will inform you about the current documentation of the work.**

#### Service works

In the Digital Maintenance Plan, your SEAT authorised service or specialised workshop documents the following information:

- When each one of the services was carried out.
- Whether a specific repair has been suggested, e.g. changing the brake pads in the near future.
- If you have expressed a special request for the maintenance. Your Service Advisor will write the work order.
- The components or fluids that were changed.
- The date of the next service.

The Long Life Mobility Warranty is valid until the next inspection. This information is documented in all checks performed.

The type and the volume of the service may vary from one vehicle to another. A specialised workshop will be able to provide specific information on the jobs for your vehicle.

#### WARNING

**If the services are insufficient or not performed and if the service intervals are not observed, the vehicle may be immobilised in traffic cause an accident and severe injuries.**

- **Make sure that any repairs are carried out by a SEAT authorised service or specialised workshop.**

#### CAUTION

**SEAT cannot be held liable for any damage to the vehicle due to insufficient work or of lack of availability of spare parts.**

#### Note

**Regular services on the vehicle not only maintain its value, but also its correct operation and road safety. For this reason, conduct the services in accordance with SEAT guidelines.**

### Set Service Intervals

#### Service interval display

At SEAT, the dates of the services are indicated by the service intervals display of the instrument panel  **page 63**.

The service intervals display informs of the dates of the services. When it is time to perform the corresponding service, other necessary additional work may also be done, such as changing the brake fluid.

## Information about the terms of use

The service intervals and groups are usually based on **normal conditions of use**.

If, on the other hand, the vehicle is under **adverse conditions of use**, some of the work must be carried out before the next service period or even between service intervals.

### Conditions of use adverse include:

- Using the vehicle in areas with thick dust.
- Using the vehicle mostly in situations with a lot of traffic and stops (e.g. in a city).
- Using the vehicle mostly in winter.

### This applies especially for the following parts (depending on equipment):

- Dust and pollen filter
- Air Care allergen filter

**The Service Advisor of your specialised workshop will gladly inform you** about the need of performing service work between normal service intervals, always considering the conditions of use of your vehicle.

## Additional service offers

### Approved spare parts

Original SEAT Spare Parts have been conceived for their vehicles and approved by SEAT, with a special emphasis on safety. These parts correspond exactly to the manufacturer's requirements in terms of design, accuracy of the measurements and materials. The original SEAT Spare Parts have been conceived exclusively for your vehicle. For this reason, we always recommend the use of Original SEAT Spare Parts. SEAT cannot be held liable for the safety and suitability of parts from other manufacturers.

### Approved spare parts

The approved exchange parts, following the manufacturer's instructions, constitute another service available to you, offering the possibility of replacing complete sets, among which the best known are: control units, electrical elements, etc.

These parts are, **approved parts**, and are the same as the factory parts, which are also approved spare parts.

## Original accessories

We recommend you only use SEAT Original Accessories and SEAT approved accessories for your vehicle. The reliability, safety and suitability of these accessories have been inspected specifically for this type of vehicle. SEAT cannot be held liable for the safety and suitability of parts from other manufacturers.

## SEAT Service Mobility

Since the moment you purchase your SEAT vehicle you will be able to enjoy the benefits and coverage of the SEAT Mobility Service.

For the first two years after the purchase, your new SEAT vehicle is automatically covered by the SEAT Mobility Service without additional costs.

If you wish to enjoy this service after this period, you can extend SEAT Mobility as long as you carry out the recommended Inspection and Maintenance Services at a SEAT Authorised Service.

If your SEAT vehicle is immobilised due to a fault or an accident, our assistance services will help you keep moving.

Take into account that the SEAT Mobility Service differs depending on the country in which the vehicle was purchased. For further »

information ask your SEAT dealership or the SEAT website in your country.

## Warranty

### Fault-free operation warranty

SEAT Authorised Services ensure the perfect condition of new vehicles. Check the purchase agreement or complementary additional documentation provided by your Technical Service to see the conditions and the terms of the warranty. Consult further information in this regard in your SEAT Official Service.

### Commercial warranty for the high-voltage battery of electric and hybrid vehicles of SEAT S.A.

1. Complementing the aforementioned warranties, the seller SEAT dealer grants the high-voltage batteries of the vehicles that it has sold an 8-year or 160,000-km warranty, whichever comes first, for any material or finish defect.
2. The reduction of the battery's capacity over time is conditioned by the component itself and does not represent a defect from a warranty point of view, provided said capaci-

ty is not below 70% of the useful capacity before 8 years or 160,000 km have passed, whichever comes first.

3. The warranty for high-voltage batteries will be invalidated when the defect is due to use, handling or maintenance not in accordance with the content of the instruction manual. This is particularly applicable the battery charge.
4. In addition, except for the duration of the warranty, all conditions relating to the legal warranty of the SEAT dealer (requirements, criteria for assessing the absence of defects, exclusion grounds, processing of entitlements to benefits, entry into force, start and scope of the warranty validity period, etc.) shall apply in relation to the high-voltage battery.

## Vehicle maintenance

### Maintenance and cleaning

#### Basic observations

Regular and careful care helps to maintain the value of your vehicle. In addition, it may become a prerequisite to demand the warranty in the event of corrosion damage and deficiencies in the paint coat of the body-work.

Specialised workshops have the necessary care products. Please follow the instructions for application on the packaging.

#### WARNING

- Cleaning products and other materials used for car care can be damaging to your health if misused.
- Always keep care products in a safe place, out of the reach of children. Danger of poisoning!

#### For the sake of the environment

- When purchasing car care products, chose products that are compatible with the environment.
- The waste from car-care products should not be disposed of with ordinary household waste.

### Washing the vehicle

The longer you take to clean the tanks, e.g. remains of insects, bird excrements, tree resin or anti frost salt adhered to your vehicle, the more damage it can cause to the surface. High temperatures, for instance strong sunlight, further intensify the damage.

Before washing the car, soften the dirt using plenty of water.

To remove encrusted dirt such as insects, bird droppings or tree resin, use a lot of water and a microfibre cloth.

Have the underside of the vehicle washed after the end of the anti frost salts in winter.

### High pressure cleaning equipment

When washing the vehicle with a high-pressure cleaner, always follow the operating instructions for the equipment. This applies particularly to the operating pressure and the distance between the spraying water. Do not point the jet directly towards the side windows, doors or covers; the same applies for the tyres, rubber hoses, damping material, sensors\* or camera lenses\*. Keep a distance of at least 40 cm.

Do not remove snow and ice with a high-pressure cleaner.

Do not use a nozzle that sprays the water out in a direct stream or one that has a rotating jet for forcing off dirt.

The water temperature must not exceed 60°C.

### Automatic car washes

Spray the vehicle before starting the car wash.

Make sure that the windows are closed and the windscreen wipers are deactivated. Bear in mind the instructions of the car wash tunnel operator, especially if your vehicle has detachable parts.

Use of car washes without brushes if possible.

### Washing by hand

Clean your vehicle from top to bottom with a soft sponge or with a brush. Only use cleaning products that do not contain solvents.

### Washing vehicles with a matte paint by hand

To prevent damage to the vehicle when washing it, first remove the thicker dust and dirt. To remove traces of insects, grease and fingerprints, it is best to use a special cleaner for matte paint.

Apply the product with a microfibre cloth. To avoid damaging the surface of the paint, do not apply too much pressure.

Rinse with plenty of water. Then clean it with a neutral cleaning product and a soft microfibre cloth.

Rinse the vehicle again with plenty of water and then leave it to dry. Remove traces of water with a leather cloth.

### ⚠ WARNING

- Only wash the vehicle with the ignition switched off or according to the specifications of the car wash tunnel operator. Risk of accident!
- When cleaning the underbody or the inside of the wheel arches, protect yourself from sharp or pointy metal parts. Risk of cut!
- After cleaning the brakes could act more slowly due to moisture or, in winter, the ice on the brake discs and pads. Risk of accident! In this case the brakes should be dried by pressing the brake pedal several times.

### ⓘ CAUTION

- Before washing the vehicle in an automatic car wash, please make sure to retract the exterior mirrors to prevent them from being damaged. The electric folding\* exterior mirrors should only be folded electrically!
- Do not wash the vehicle in direct sunlight. Risk of damaging the paint job!

»

- Do not use sponges, abrasive household sponges or similar to clean insect remains. Risk of damaging the surface!

- Vehicle parts with matte paint:

- Do not use polish or hard wax. Risk of damaging the surface!
- Never select washing programmes that include the use of wax. This could damage the appearance of matte paint.
- Do not put stickers or magnets on parts with matte paint, as removing them may damage the paint.



#### For the sake of the environment

The car should only be washed in special wash bays. These places are designed to prevent the water that is used for washing, which may be contaminated, from entering the drains.

## Cleaning and maintenance instructions

The cleaning and maintenance of individual components of the vehicle can be checked in the following tables. The contents should be understood merely as a recommendation. Go to your specialised workshop if you have special questions or parts that are not listed. Take the general considerations into account >>>  in **Take special care with...** on page 201.

## Cleaning the exterior

### Windscreen wipers

Problem	Solution
Dirt	Soft cloth with wipers

### Headlights / Tail lights

Problem	Solution
Dirt	Soft sponge with neutral soap solution <sup>a1</sup>

<sup>a1</sup> Neutral soap solution: two tablespoons maximum in 1 litre of water

### Sensors / Camera lenses

Problem	Solution
Dirt	<i>Sensors:</i> soft cloth with a solvent-free cleaning product <i>Camera lenses:</i> soft cloth with an alcohol-free cleaning product
Snow/ice	Hand brush/Anti frost spray with no solvents

### Wheels

Problem	Solution
Antifreeze salt	Water
Brake abrasion dust	Acid-free special cleaning product

### End exhausts

Problem	Solution
Antifreeze salt	Water, if a steel cleaning product is required

### Covers / Trims

Problem	Solution
Dirt	Neutral soap solution <sup>a1</sup> , if a steel cleaning product is required

<sup>a1</sup> Neutral soap solution: two tablespoons maximum in 1 litre of water

### Paint

Problem	Solution
Paint flaws	Check the paint's colour code in an authorised service and restore with a touch-up pencil
Spilled fuel	Immediately rinse with water
Environmental rust tank	Apply rust remover and then apply hard wax. Go to your specialised workshop if you have any queries
Corrosion	Have your specialised workshop take care of this
The water does not create droplets on the clean paint	Maintain with hard wax (at least 2 times a year)



Problem	Solution
No shine despite sober maintenance/paint	Treat with suitable wax and apply paint preservative afterwards if the wax used does not contain preservative ingredients
Tanks, e.g. insect remains, bird droppings, tree sap, road salt	Immediately soften with water and remove with a microfibre cloth
Fat-based dirt, e.g. cosmetic products or sunscreen	Delete immediately with a neutral soap solution <sup>a1</sup> and a soft cloth

<sup>a1</sup> Neutral soap solution: two tablespoons maximum in 1 litre of water

## Carbon fibre parts

Problem	Solution
Dirt	Clean the same way as painted parts » page 197

## Decoration slides

Problem	Solution
Dirt	Soft sponge with neutral soap solution <sup>a1</sup>

<sup>a1</sup> Neutral soap solution: two tablespoons maximum in 1 litre of water

## Interior cleaning

### Windows

Problem	Solution
Dirt	Apply windscreen cleaner and then dry with a cloth

### Covers / Trims

Problem	Solution
Dirt	Neutral soap solution <sup>a1</sup>

<sup>a1</sup> Neutral soap solution: two tablespoons maximum in 1 litre of water

### Plastic parts

Problem	Solution
Dirt	Damp cloth
Encrusted dirt	Neutral soap solution <sup>a1</sup> , if possible solvent-free plastic cleaner

<sup>a1</sup> Neutral soap solution: two tablespoons maximum in 1 litre of water

### Displays/instrument panel

Problem	Solution
Dirt	Soft cloth with a liquid crystal display cleaner

## Control panels

Problem	Solution
Dirt	Soft brush, then soft cloth with neutral soap solution <sup>a1</sup>

<sup>a1</sup> Neutral soap solution: two tablespoons maximum in 1 litre of water

## Seat belts

Problem	Solution
Dirt	Neutral soap solution <sup>a1</sup> , allowed to dry before retracting

<sup>a1</sup> Neutral soap solution: two tablespoons maximum in 1 litre of water

## Fabrics, artificial, Alcantara leather

Problem	Solution
Particles of dirt stuck to surfaces	Vacuum cleaner
Water-based dirt, e.g. coffee, tea, blood etc.	Absorbent cloth and neutral soap solution <sup>a1</sup>
Grease-based dirt, e.g. oil, makeup, etc.	Apply a neutral soap solution <sup>a1</sup> . Absorb the dissolved grease and paint particles drying with an absorbent cloth, in case you must treat it with water afterwards

»

Problem	Solution
Special dirt, e.g. pens, nail polish, dispersion paint, shoe cream etc.	Special stain remove: dry with an absorbent cloth, if applicable, apply neutral soap solution afterwards <sup>a1</sup>

<sup>a1</sup> Neutral soap solution: two tablespoons maximum in 1 litre of water

### Natural leather

Problem	Solution
Recent dirt	Cotton cloth with neutral soap solution <sup>a1</sup>
Water-based dirt, e.g. coffee, tea, blood etc.	Recent stains: absorbent cloth Dry stains: stain remover suitable for leather
Grease-based dirt, e.g. oil, make-up, etc.	Recent stains: absorbent cloth and suitable stain remover for leather Dry stains: grease solvent spray
Special dirt, e.g. pens, nail polish, dispersion paint, shoe cream etc.	Stain remover suitable for leather
Care	Apply preservative cream regularly to protect from sunlight. Use a colour preservative if required

<sup>a1</sup> Neutral soap solution: two tablespoons maximum in 1 litre of water

### Carbon fibre parts

Problem	Solution
Dirt	Clean like plastic parts

### Take special care with...

#### Headlights/tail lights

- Do not clean the headlights/tail lights with a dry cloth or sponge.
- Do not use cleaning products that contain alcohol. Risk of cracks!

#### Wheels

- Do not use for paint wax or other abrasive products.
- If the protective coating on the paint of the rim has been damaged due to stone impacts, scratches, etc., the damage should be repaired immediately.

#### Camera lenses

- Do not use hot or warm water to remove ice or snow from the camera lenses. Risk of cracking the lens!
- To clean the camera lens, never use abrasive cleaning products or products with alcohol. Risk of scratches and cracks!

### Windows

• Remove snow and ice from windows and exterior mirrors with a plastic scraper only. To avoid scratches, the scraper should only be pushed in one direction and not moved to and fro.

- Never remove snow or ice from windows and rearview mirrors with warm or hot water. Risk of cracks on the windows!
- To prevent damage to the heating of the rear window, do not put stickers over the heating elements.

### Covers/trims

- Do not use cleaning products or chrome based cleaning agents.

### Paint

- The vehicle must be free from dirt and dust before applying wax or care products. Risk of scratches!
- Do not apply wax or care products if the vehicle is exposed to direct sunlight. Risk of damaging the paint job!
- The ambient rust deposits must not be removed through friction. Risk of damaging the paint job!
- Remove cosmetic products and sunlight immediately. Risk of damaging the paint job!

### Displays/instrument panel

- The displays, the instrument panel and the trim around it must not be cleaned dry. Risk of scratches!
- Make sure that the instrument panel is switched off and cooled down before cleaning.
- Make sure that no liquid leaks between the instrument panel and the trim. Risk of damage!

### Control panels

- Make sure that no liquid leaks into the control panels. Risk of damage!

### Seat belts

- Do not remove the seat belts to clean them.
- Seat belts and their components must never be cleaned with chemical products, nor should they be allowed to come into contact with corrosive liquids, solvents or sharp objects. Risk of damaging the fabric!
- If you find any damage to the belt webbing, belt fittings, the belt retractor or the buckle, ask your specialised workshop to replace the belt in question.

### Fabrics/artificial leather/Alcantara leather

- Do not treat artificial leather/Alcantara leather with leather cleaning products, solvents, wax polish, shoe cream, stain removers or similar products.

- If the stain is very hard to remove, take the vehicle to a specialised workshop to have it removed there. This will prevent damage.
- Do not use steam cleaners, brushes, hard sponges, etc. to clean.
- Do not turn on seat heating\* to dry the seats.
- Sharp objects on clothing, such as zips, rivets or belts can damage the surface.
- Open Velcro, e.g. on clothes can damage the seat upholstery. Make sure that Velcro fasteners are closed.

### Natural leather

- Never use solvents, wax polish, shoe cream, spot removers or similar products on leather.
- Sharp objects on clothing, such as zips, rivets or belts can damage the surface.
- Do not use steam cleaners, brushes, hard sponges, etc. to clean.
- Do not turn on seat heating\* to dry the seats.
- Avoid exposing leather to direct sunlight for long periods, otherwise it may tend to lose some of its colour. If the car is left for a prolonged period in the bright sun, it is best to cover the leather.

### WARNING

**Do not use water-repellent coatings on the windscreen. In bad visibility conditions**

**such as humid weather, darkness or when the sun is in its lowest point, visibility may be impacted. Risk of accident! Such coatings can also cause the windscreen wiper blades to make noise.**

### Note

- **Remains of insects can be removed much more easily with previously treated paint.**
- **Regular car care treatments can prevent deposits of ambient rust.**

### Remove the vehicle from traffic

If you want to leave your vehicle stationary for a long period of time, contact a qualified workshop. They will gladly inform you about the necessary measures, such as anti-corrosion protection, Service and storage.

Also bear in mind the indications regarding the vehicle's batteries.

## Accessories and modifications to the vehicle

### Accessories, spare parts and repair work

#### Introduction

Always ask your dealer or specialist retailer for advice before purchasing accessories and replacement parts.

Your vehicle is designed to offer a high standard of active and passive safety. For this reason, we recommend that you ask a SEAT Official Service for advice before fitting accessories or replacement parts. Your SEAT Official Service has the latest information from the manufacturer and can recommend accessories and replacement parts which are suitable for your requirements. They can also answer any questions you might have regarding official regulations.

We recommend only using **SEAT accessories** and **genuine SEAT parts**®. SEAT has tested these parts and accessories for suitability, reliability and safety. SEAT Official Services have the necessary experience and facilities to ensure that the parts are installed correctly and professionally.

Any **retro-fitted equipment** which has a direct effect on the vehicle and/or the way it is driven, such as a cruise control system or **electronically-controlled suspension**, must be approved for use in your vehicle and bear the **e** mark (the European Union's authorisation symbol).

If **any additional electrical devices** are fitted which do not serve to control the vehicle itself (for instance a refrigerator box, laptop or ventilator fan, etc.), they must bear the **CE** sign (manufacturer conformity declaration in the European Union).

#### WARNING

**Accessories, for example telephone holders or cup holders, should never be fitted on the covers, or within the working range of the airbags. Otherwise, there is a danger of injury if the airbag is triggered in an accident.**

#### Technical modifications

Unauthorised modifications to the electronic components, software, wiring or data transfer in the vehicle may cause malfunctioning.

You will appreciate that your SEAT dealership cannot be held liable for any damage caused by modifications and/or work performed incorrectly.

For this reason we recommend asking official SEAT service centres to do any necessary work using **genuine SEAT parts**®.

#### WARNING

**Incorrectly performed modifications or other work on your vehicle can lead to malfunctions and cause accidents.**

### Radio telephones and office equipment

#### Radio transmitters (fixed installation)

Any retrofit installations of radio transmitters in the vehicle require prior approval. SEAT generally authorises in-vehicle installations of approved types of radio transmitters provided that:

- The antenna is installed correctly.
- The aerial is installed on the exterior of the vehicle (and shielded cables are used together with non-reflective aerial trimming).
- The effective transmitting power does not exceed 10 Watts at the aerial base.

A SEAT Official Service and specialised workshop will be able to inform you about options for installing and operating radio transmitters with a *higher* transmitting power.

**Mobile radio transmitters**

Commercial mobile telephones or radio equipment might interfere with the electronics of your vehicle and cause malfunctions. This may be due to:

- No external aerial.
- External aerial incorrectly installed.
- Transmitting power more than 10 W.

You must, therefore, do not operate portable mobile telephones or radio equipment *inside the vehicle* without a properly installed external aerial »»» ⚠.

Please note also that the maximum range of the equipment can only be achieved with an *external* aerial.

**Business equipment**

Retrofit installation of business or private equipment in the vehicle is permitted, provided the equipment cannot interfere with the driver's immediate control of the vehicle and that any such equipment carries the **CE** mark. Any retrofit equipment that could influence the driver's control of the vehicle must have a type approval for your vehicle and must carry the **e** mark.

a properly installed external aerial can create excessive magnetic fields that could cause a health hazard.

**Note**

- The posterior fitting of electric and electronic equipment in this vehicle affects its licence and could lead to the withdrawal of the vehicle registration document under certain circumstances.
- Please use the mobile telephone/radio operating instructions.

**⚠ WARNING**

**Mobile telephones or radio equipment which is operated inside the vehicle without**

## Information for the user

### Information for the user

### Information stored by the control units

#### Description and operation

Your vehicle is fitted with a series of electronic control units that, among others, are responsible for the engine management. In addition, the control units monitor the proper functioning of the airbags.

Therefore, while the vehicle is being driven, these electronic control units are continuously analysing the vehicle data. In the event of faults or deviations from the theoretical values, only this data is stored. Normally, the warning lamps on the instrument panel light up in the event of faults.

This data can only be read and analysed using special equipment.

The storing of the data allows specialised workshops to detect and repair faults. Stored data may include:

- Data referring to the engine
- Speed
- Direction of travel

- Braking force
- Detection of seat belt

The vehicle control units never record conversations held by passengers in the vehicle.

In vehicles equipped with an emergency call function via the mobile phone or other appliances connected in the vehicle, it is possible to send the vehicle position. If the control unit records an accident with airbag activation, the system may automatically send a signal. This will depend on the network operator. Normally, transmission is only possible in areas with good coverage.

#### Event Data Recorder

The vehicle is **not** fitted with an event data recorder.

An event data recorder temporarily stores the vehicle information. Therefore, in the event of an accident, it is possible to obtain detailed information about how the accident occurred. Vehicles with airbag systems can store data relating to impact speed, seat belt status, seat positions and airbag activation times may be stored, etc. The volume of data depends on the manufacturer.

Event data recorders can only be mounted with authorisation from the vehicle owner and, in some countries, they are governed by local legislation.

#### Reprogramming of control units

On the whole, all the data required for the component management is stored in the control units. The programming of certain convenience functions, such as the turn signals, individual door opening and instructions on the display can be modified using special equipment at the workshop. If the comfort functions are reprogrammed, the information and Instruction Manual descriptions will not coincide with the modified functions. Therefore, SEAT recommends that any modifications be recorded in the section "Other workshop notes" in the Maintenance Programme.

The SEAT Official Service must have a record of any modification to the programming.

#### Reading the vehicle's fault memory

There is a diagnostics connector in the vehicle interior for reading the vehicle fault memory. The fault memory documents errors and deviations from the theoretical values of the electronic control units.

The diagnostics connector is in the driver side footwell area, next to the lever for opening the bonnet, below a cover.

The fault memory should only be read and reset by a specialised workshop.

## Other important information

### Environmental compatibility

Environmental protection is a top priority in the design, choice of materials and manufacture of your new SEAT.

#### Constructive measures to encourage recycling

- Joints and connections designed for easy dismantling.
- Modular construction to facilitate dismantling.
- Increased use of single-grade materials.
- Plastic parts and elastomers are marked in accordance with ISO 1043, ISO 11469 and ISO 1629.

#### Choice of materials

- Use of recycled materials.
- Use of compatible plastics in the same part if its components are not easily separated.
- Use of recycled materials and/or materials originating from renewable sources.
- Reduction of volatile components, including odour, in plastic materials.
- Use of CFC-free coolants.

**Ban on heavy metals, with the exceptions dictated by law [Annex II of ELV Directive**

**2000/53/EC):** cadmium, lead, mercury, hexavalent chromium.

#### Manufacturing methods

- Reduction of the quantity of thinner in the protective wax for cavities.
- Use of plastic film as protection during vehicle transport.
- Use of solvent-free stickers.
- Use of CFC-free coolants in cooling systems.
- Recycling and energy recovery from residues (RDF).
- Improvement in the quality of waste water.
- Use of systems for the recovery of residual heat (thermal recovery, enthalpy wheels, etc.).
- The use of water-soluble paints.

### Stickers and plates

Some parts in the engine compartment come from the factory with certificates of safety, labels or plates containing important information regarding the operation of the vehicle, for example, on the battery charging socket flap, on the passenger's sun visor, on the driver door strut, or on the floor of the luggage compartment.

- Never remove these certificates of safety, labels or plates, and ensure they are kept in good condition and are legible.
- If a vehicle part, bearing a certificate of safety, label or plate, is replaced, the specialised workshop should attach the information back in the same place.

#### Certificate of safety

A certificate of safety on the door strut states that all the safety standards and regulations established by the national traffic authorities responsible for road safety were met at the time of manufacture. It may also give the month and year of manufacture, together with the chassis number.

#### Warning of high voltage label

There is a label close to the bonnet lock which warns of high voltage in the vehicle's electrical system.

### Using the vehicle in other countries and continents

The vehicle is manufactured at the factory for use in a particular country in accordance with the national legislation in force at the time of manufacture.

If the vehicle is sold in another country or used in another country for an extended

»

period of time, the applicable legislation of that country should be observed.

It may be necessary to fit or remove certain pieces of equipment or to deactivate certain functions. Service work may also be affected. This is particularly true if the vehicle is used in a different climate for an extended period of time.

#### **ⓘ CAUTION**

- SEAT does not accept liability for any damage to the vehicle due to an inadequate service or the non-availability of genuine spare parts.
- SEAT does not accept liability if the vehicle does not comply in part or in full with the legal requirements of other countries or continents.

#### **Radio and antenna reception**

For factory-fitted radio equipment, the aerial for radio reception is fitted to the roof of the vehicle.

#### **ℹ Note**

If electrical equipment such as mobile telephones, is used near a roof aerial, you may observe interference in the reception of AM stations.

#### **Information about SEAT repairs**

##### **⚠ WARNING**

**Repairs or modifications which are not performed correctly may result in damage or errors in the vehicle operation, affecting the effectiveness of the driver assist and airbag systems. This could result in serious accident.**

- Have any repairs or modifications carried out at a specialised workshop.

#### **Declaration of conformity**

The respective manufacturer hereby declares that the products indicated below comply with basic requirements and the following provisions and important legislation on the date of manufacture of the vehicle, among others FCC Part 15.19, FCC Part 15.21 and RSS-Gen Issue 1:

##### **Radio frequency equipment**

- Electronic gearbox lock.
- Vehicle key

##### **Electrical equipment**

- 12 volt power socket

#### **Collection of end-of-life vehicles and scrapping**

##### **Collection of end-of-life vehicles**

SEAT is already prepared for the moment when you wish to scrap your vehicle and offers you an environmentally-friendly solution. An extensive network of used car reception centres already exists in much of Europe. After the vehicle has been delivered, you will receive a certificate of destruction describing the environmentally friendly scrapping of the vehicle in accordance with applicable legislation.

We will collect the used vehicle free of charge, provided it complies with all national legislation.

Please see your technical service for further information about the collection and scrapping of end-of-life vehicles.

##### **Scrapping**

The relevant safety requirements must be observed when the vehicle or components of the airbag or belt tensioner systems are scrapped. These requirements are known to specialised workshops.



## Recycling of electrical or electronic devices

All electrical or electronic devices (EED) that are not permanently fitted in the vehicle must be marked with the following symbol:



This symbol indicates that EED must not be discarded as home waste but through selective waste collection.

## Information about the EU Directive 2014/53/EU

### Simplified EU compliance declaration

Your vehicle has different radioelectrical devices. The manufacturers of these devices de-

clare that they comply with Directive 2014/53/EU when legally required.

The full text of the EU compliance declaration is available online at the following address:

[www.seat.com/generalinfo](http://www.seat.com/generalinfo)



### Addresses of the manufacturers

According to the Directive 2014/53/EU, all relevant components must include the address of the manufacturer.

The address of the manufacturers of components that, due to their size or nature, cannot include a sticker are listed below, as long as it is legally required:

Radioelectrical equipment fitted in the vehicle	Addresses of the manufacturers
Radiofrequency remote control key	Della KGaA Hueck & Co. Rixbecker Straße 75 59552 Lippstadt, GERMANY
Radio frequency remote control (auxiliary heater)	Digades GmbH Äußere Weberstraße 20 02763 Zittau, GERMANY
Transmitted-Receiver (independent heating)	Webasto Thermo & Comfort SE Friedrichshafener Str. 9 82205 Gilching, GERMANY
Radars sensors for assistance systems	ADC Automotive Distance Control Systems GmbH Peter-Dornier-Straße 10 88131 Lindau, GERMANY
	Robert Bosch GmbH Postfach 16 61 71226 Leonberg, GERMANY

## Frequency bands, station power

Radioelectrical equipment <sup>a)</sup>	Frequency band	Max. station power	Valid for models
Radiofrequency remote control (vehicle)	433.05-434.78 MHz	10 mW (ERP)	All SEAT models
	433.05-434.79 MHz	10 mW	
	868.0-868.6 MHz	25 mW	
	434.42 MHz	32 µW	
Radio frequency remote control (auxiliary heater)	868.7-869.2 MHz (869.0 MHz)	25 mW	Leon, Ateca and Tarraco
	868.0-868.6 MHz (868.3 MHz)	3.1 mW	Alhambra
Transmitted-Receiver (independent heating)	868.0-868.6 MHz (868.3 MHz)	23.5 mW	Alhambra
	868.7-869.2 MHz (869.0 MHz)	23.5 mW	Leon, Ateca and Tarraco
Bluetooth	2402-2480 MHz	6 dBm	All SEAT models
	2400-2483.5 MHz	10 dBm	
Connection to the external antenna of the car	GSM 900: 880-915 MHz	33 dBm	Leon, Ateca, Alhambra and Tarraco
	GSM 1800: 1710-1785 MHz	30 dBm	
	WCDMA FDD I: 1920-1980 MHz	24 dBm	
	WCDMA FDD III: 1710-1785 MHz	21 dBm	Tarraco and Leon
	WCDMA FDD VIII: 880-915MHz	21 dBm	
	LTE FDD1: 1920-1980 MHz	23 dBm	
	LTE FDD3: 1710-1785 MHz	23 dBm	
	LTE FDD7: 2500-2570 MHz	23 dBm	
	LTE FDD8: 880-915 MHz	23 dBm	
	LTE FDD20: 832-862 MHz	23 dBm	

## Information for the user

Radioelectrical equipment <sup>a)</sup>	Frequency band	Max. station power	Valid for models
Wireless hotspot	2400-2483.5 MHz	10 dBm	Leon, Ateca and Tarraco
Keyless Access	434,42 MHz	32 $\mu$ W	Ibiza, Arona, Leon, Ateca and Tarraco
Radar sensors for assistance systems	76 GHz-77 GHz	28.2 dBm	Leon and Alhambra
		35.0 dBm	Ibiza, Arona, Ateca and Tarraco
	24050-24250 MHz	20 dBm	Arona, Ateca, Tarraco and Alhambra
Wireless charging	110-120 kHz	10 W	Ibiza, Arona, Leon, Ateca and Tarraco
	111-120 kHz	10 W	New Leon
Instrument panel	125 kHz	40 dB $\mu$ A/m	Ibiza, Arona, Ateca, Tarraco and Alhambra
Online Connectivity Unit	EGSM900: 880-915 MHz	33 dBm	Ibiza, Arona, Leon, Ateca and Tarraco
	DCS1800: 1710-1785 MHz	31 dBm	
	UMTS FDD 1: 1920-1980 MHz	24 dBm	
	UMTS FDD 3: 1710-1785 MHz	24 dBm	
	UMTS FDD 8: 880-915 MHz	24 dBm	
	E-UTRA FDD 1: 1920-1980 MHz	23.5 dBm	
	E-UTRA FDD 3: 1710-1785 MHz	23.0 dBm	
	E-UTRA FDD 7: 2500-2570 MHz	23.5 dBm	
	E-UTRA FDD 8: 880-915 MHz	23.0 dBm	
	E-UTRA FDD 20: 832-862 MHz	23.5 dBm	
E-UTRA FDD 28: 703-748 MHz	23.0 dBm		

<sup>a)</sup> The commissioning or authorisation of radioelectrical technology may be restricted in some European countries, forbidden or only allowed with additional requirements. »

Hereby, Molex CVS Dabendorf GmbH declares that the radio equipment type LTE-MBC-EU2 is in compliance with Directive 2014/53/EU. The full text of the EU declaration of conformity is available at the following internet address:

<http://www.molex.com/doc>

## Technical data

### Indications about the technical data

### Important information

#### Introduction

The values indicated in the technical data may differ depending on optional equipment or version of the model, as well as in the case of special vehicles and equipment for certain countries.

The information in the official vehicle documentation takes precedence at all times.

#### Abbreviations used in the Technical Specifications section

kW	Kilowatt, engine power measurement.
PS	Horsepower (not currently used), engine power measurement unit.
rpm, 1/min	Revolutions per minute - engine speed.
Nm	Newton metres, unit of engine torque.

#### Vehicle identification data

##### Vehicle identification number

The vehicle identification number (vehicle ID number) can be read from the outside of the vehicle through a window located on the windscreen. This viewer is located in the lower part of the windscreen. The vehicle identification number (chassis number) is also stamped on the right water drain channel. The water drain channel is located between the suspension tower and the wing. Open the bonnet to read the vehicle identification number .

##### Type plate

The type plate is located on the vehicle's right hand door frame. Vehicles for certain export countries do not have a type plate.

#### Filling capacities

##### Capacity of the windscreen washer fluid container

Windscreen washer fluid container	approx. 3 litres
-----------------------------------	------------------

#### Weights

##### Load on the roof

The maximum authorised load on the roof of your vehicle is 50 kg.

##### Empty weight, total weight, axle loads

The empty weight of the vehicle with driver (75 kg) was calculated according to the (EU) 1230/2012 standard. Optional equipment can increase the empty weight, which means that the possible useful load decreases proportionally.

#### WARNING

**The values indicated for the maximum permitted weights must not be exceeded. There is a risk of accident and damage!**

## Engine specifications

Electric engine	
Power kW (CV)	61 (82)
Maximum torque (Nm)	210
Gearbox	automatic
Top speed (km/h)	130
Acceleration from 0-100 km/h (seconds)	12.3
Maximum authorised weight (kg)	1,530

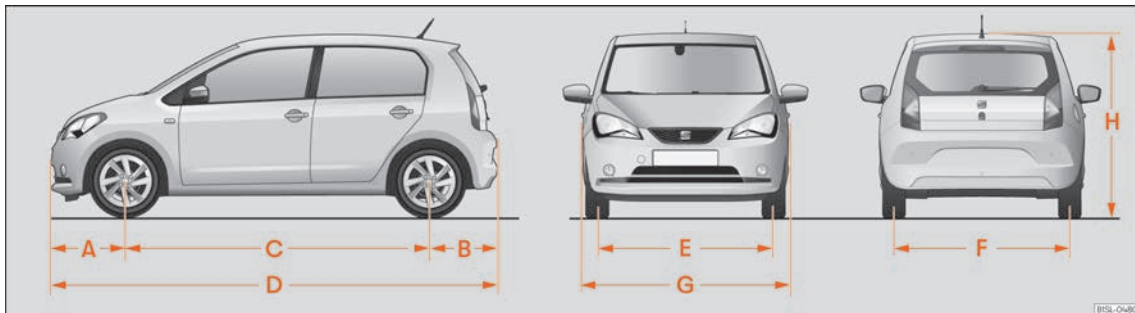
**Dimensions.**

**Fig. 170** Dimensions.

		Mii
A/B	Front and rear projection (mm)	595/542
C	Wheelbase (mm)	2,420
D	Length (mm)	3,557
E/F	Front/rear <sup>a1</sup> track width (mm)	1,428/1,424
G	Width (mm)	1,645
H	Height at kerb weight (mm)	1,478
	Turning radius (m)	approx. 9.8

<sup>a1</sup> This data will change depending on the type of wheel rim. Values for wheel 185/70 R14 ET38.





# Index

## Numbers and Symbols

### 12-volt battery

assisted start .....	44
charging .....	184
disconnect and connect .....	182, 184
electrolyte level .....	183
location .....	182
replacement .....	184
winter operations .....	182

## A

### ABS

see Anti-lock brake system .....	153
----------------------------------	-----

Accessories .....	202
-------------------	-----

### Adjust

front seats .....	86
lights .....	80
seats .....	11

Adjusting the seat belt .....	18
-------------------------------	----

Airbags .....	20
---------------	----

description .....	20
-------------------	----

Airbag system .....	20
---------------------	----

activation .....	21
------------------	----

control lamp .....	22
--------------------	----

deactivation of the front airbag .....	23
--	----

description .....	20
-------------------	----

front airbags .....	22
---------------------	----

how it works .....	21
--------------------	----

### Air conditioning

Climatronic .....	101
-------------------	-----

usage instructions .....	102
--------------------------	-----

Air recirculation .....	103
-------------------------	-----

Air vents .....	102
-----------------	-----

### Alternator

warning lamp .....	185
--------------------	-----

Ambient lighting .....	81
------------------------	----

Antenna .....	206
---------------	-----

Anti-lock brake system .....	153
------------------------------	-----

Anti-puncture .....	35, 36
---------------------	--------

Anti-puncture kit .....	34, 35
-------------------------	--------

check after 10 minutes .....	37
------------------------------	----

components .....	36
------------------	----

inflating the tyre .....	36
--------------------------	----

sealing the tyre .....	36
------------------------	----

Anti-puncture set .....	35
-------------------------	----

Antifreeze .....	178
------------------	-----

Aspects to think about before starting the vehicle .....	10
--	----

ASR .....	
-----------	--

see Traction control system .....	153
-----------------------------------	-----

Assistance systems .....	
--------------------------	--

cruise control .....	146
----------------------	-----

optical parking system (OPS) .....	156
------------------------------------	-----

parking aid .....	156
-------------------	-----

parking distance warning .....	156
--------------------------------	-----

Tyre pressure monitoring .....	192
--------------------------------	-----

Assisted start .....	44
----------------------	----

Audible warning .....	
-----------------------	--

control and warning lamps .....	65
---------------------------------	----

lights .....	76
--------------	----

unbuckled seat belt .....	14
---------------------------	----

Auto Lock (central locking) .....	70
-----------------------------------	----

Automatic car wash .....	197
--------------------------	-----

Automatic dipped beam headlight control .....	77
---	----

Automatic gearbox .....	140
-------------------------	-----

control lamp .....	140
--------------------	-----

driving tips .....	142
--------------------	-----

ignition key extraction lock .....	135
------------------------------------	-----

selector lever lock .....	141
---------------------------	-----

selector lever positions .....	140
--------------------------------	-----

AUX-IN .....	124
--------------	-----

AUX-IN multimedia socket .....	124
--------------------------------	-----

## B

### Backrest of the rear seat

folding .....	88
---------------	----

raise .....	88
-------------	----

Bag hooks .....	92, 96
-----------------	--------

Bag support .....	95
-------------------	----

Battery .....	68
---------------	----

Before starting the vehicle .....	10
-----------------------------------	----

Belt tightening .....	19
-----------------------	----

Blown bulbs .....	
-------------------	--

change a bulb .....	49
---------------------	----

Bluetooth .....	123
-----------------	-----

Bonnet .....	176
--------------	-----

opening and closing .....	177
---------------------------	-----

Brake fluid .....	180
-------------------	-----

Brakes .....	150
--------------	-----

brake fluid .....	180
-------------------	-----

brake servo .....	150
-------------------	-----

braking assistant .....	153
-------------------------	-----

handbrake .....	152
-----------------	-----

new brake pads .....	150
----------------------	-----

Braking assistant .....	153
-------------------------	-----

Braking system .....	
----------------------	--

warning lamp .....	150
--------------------	-----

## C

- Camera
  - Lane Assist ..... 148
- Capacities
  - window washer water ..... 181
- Central locking ..... 69
  - central locking switch ..... 71
  - emergency lock ..... 72
  - remote control key ..... 70
  - selective unlocking system ..... 70
- Change a bulb ..... 49
  - front bumper ..... 51
  - headlights ..... 50
  - number plate light ..... 52
  - side turn signal ..... 53
  - tail lights ..... 51
- Change the wiper blades ..... 43
- Changing a wheel ..... 38
  - subsequent work ..... 42
  - wheel nuts ..... 39
- Changing parts ..... 202
- Charging cable ..... 170
  - for charging stations (AC) ..... 171
  - for sockets ..... 172
- Charging the high-voltage battery ..... 160
  - at a charging station (DC) ..... 165
  - charging process display ..... 168
  - emergency release of the charging connector ..... 169
  - from a socket or a charging station (AC) .. 164
  - home charging (wallbox) ..... 166
  - immediate charging and programmed charging ..... 167
  - problems and solutions ..... 169
- Childproof locks
  - electric windows ..... 75
- Child seats
  - group classification ..... 27
  - ISOFIX system ..... 30
  - safety instructions ..... 28
  - securing with the seat belt ..... 33
  - Top Tether system ..... 30, 32
- Cleaning the vehicle
  - Alcantara ..... 199
  - carbon fibre ..... 199, 200
  - control panels ..... 199
  - covers/ trims ..... 198, 199
  - decorative sheets ..... 199
  - end exhausts ..... 198
  - exterior ..... 198
  - fabrics ..... 199
  - headlights/tail light units ..... 198
  - high pressure cleaning equipment ..... 197
  - interior ..... 199
  - leather ..... 200
  - paint ..... 198
  - plastic parts ..... 199
  - radio screen ..... 199
  - seat belts ..... 199
  - sensors / camera lenses ..... 198
  - special care ..... 200
  - wash the vehicle ..... 197
  - wheels ..... 198
  - windows ..... 199
  - wiper blades ..... 198
- Climatronic ..... 101
- Closing ..... 69
  - bonnet ..... 177
  - luggage compartment ..... 74
  - windows ..... 75
- Coming Home ..... 79
- Connectivity ..... 129
- Contact ..... 135
- Control and warning lamps ..... 65
  - airbags ..... 23
  - airbag system ..... 22
  - alternator ..... 185
  - anti-lock brake system ABS ..... 152
  - ASR ..... 152
  - audible warning ..... 65
  - braking system ..... 150
  - cooling system ..... 178
  - cruise control (GRA) ..... 146
  - drive system ..... 135
  - EDL ..... 152
  - electromechanical steering ..... 144
  - ESC ..... 152
  - high-voltage battery ..... 160
  - Lane Assist ..... 148
  - lights ..... 76
  - replacement ..... 140
  - seat belt ..... 14
  - steering column lock ..... 144
  - tyre pressure loss indicator ..... 192
- Controls and displays
  - overview ..... 55
- Control units ..... 204
  - reprogramming ..... 204

- Cooling system  
 check the coolant ..... 179  
 control lamps ..... 178  
 refilling coolant ..... 179
- Correct driver position ..... 11
- Cruise control ..... 146  
 control and warning lamp ..... 146  
 operation ..... 147
- Cybersecurity ..... 129
- D**
- DAB ..... 118  
 main menu ..... 119  
 station update ..... 120
- Dangers of not using the seat belt ..... 16
- Data logger ..... 204
- Data transmissions ..... 129
- Deactivation of the front airbag ..... 23
- Declaration of conformity ..... 206
- Diagnostic connector ..... 204
- Digital clock ..... 57
- Digital radio  
 see DAB ..... 118
- Disposal  
 airbag system ..... 206  
 seat belt tensioners ..... 19  
 vehicle at the end of its useful life ..... 206
- Door handle  
 interior ..... 55
- Doors ..... 72  
 child lock ..... 73
- Drink holder ..... 96  
 bottle holder ..... 96  
 centre console ..... 97
- Driver ..... 11
- Drive system  
 automatic connection ..... 138  
 automatic disconnection ..... 138  
 brake energy recuperation ..... 134  
 connecting ..... 136  
 control lamp ..... 135  
 disconnecting ..... 137  
 functions ..... 133  
 problems and solutions ..... 139  
 starting ..... 135
- Driving  
 data storage ..... 204  
 driving on flooded roads ..... 145  
 parking on inclines ..... 154  
 park on upward slopes ..... 154  
 safe ..... 10  
 trips abroad ..... 81, 146
- Driving data ..... 61
- Driving data indicator ..... 61
- Driving on flooded roads ..... 145
- Driving profiles ..... 144
- Duplicate keys ..... 67
- Dust and pollen filter ..... 100
- Dynamic headlight range control ..... 80
- E**
- EDL  
 see Electronic differential lock ..... 153
- Electric devices ..... 97
- Electric range ..... 163
- Electric windows ..... 75
- Electrolyte ..... 183
- Electromechanical steering  
 control lamp ..... 144  
 lamp ..... 143  
 steering column lock ..... 143
- Electronic differential lock ..... 153
- Electronic immobilizer ..... 139
- Electronic self-locking ..... 153
- Electronic Stability Control (ESC) ..... 153
- Emergencies ..... 34  
 anti-puncture kit ..... 35  
 changing a wheel ..... 38  
 changing the battery ..... 184  
 fire extinguishers ..... 34  
 first aid kit ..... 34  
 hazard warning lights ..... 80  
 jump leads ..... 44  
 replace a blown fuse ..... 48  
 vehicle tool kit ..... 34  
 warning triangle ..... 34
- Emergency closing and opening  
 front passenger door ..... 72  
 rear lid ..... 75
- Emergency locking of the front passenger  
 door ..... 72
- Emergency opening  
 rear lid ..... 75
- Emergency release of the charging connec-  
 tor ..... 169
- energy recuperation ..... 134
- Engine  
 assisted start ..... 44  
 running in ..... 145

- Engine compartment
- battery ..... 182
  - brake fluid ..... 180
  - coolant ..... 178, 179
  - opening and closing ..... 177
  - safety instructions ..... 176
  - safety warnings ..... 174
  - window washer tank ..... 181
  - working in the engine compartment ..... 176
- Engine coolant ..... 178
- check the level ..... 179
  - G 12 plus-plus ..... 178
  - G 13 ..... 178
  - specifications ..... 178
- Engine specifications ..... 212
- Enlarge
- the luggage compartment ..... 88
- Environment
- environmental compatibility ..... 205
- Equipment ..... 202
- ESC (electronic stability control) ..... 153
- Event data recorder ..... 204
- Event Data Recorder ..... 204
- Exterior lighting
- change a bulb ..... 49
- Exterior mirrors
- fold manually ..... 85
  - settings ..... 85
- Exterior view ..... 7
- External antenna ..... 202
- Extinguisher ..... 34
- F**
- Fabrics: clean ..... 199
- Factors that have a negative influence on
- safe driving ..... 10
- Fastening rings ..... 91
- Fault memory
- connector ..... 204
  - reading ..... 204
- Filling capacities
- window washer tank ..... 211
- First aid kit
- housing ..... 34
- Front airbags ..... 22
- control lamp ..... 22
- Full-LED headlights ..... 49
- Fuses ..... 47
- colour coded ..... 48
  - fuse box ..... 47, 48
  - preparations for replacing fuses ..... 48
  - recognise blown fuses ..... 48
  - replace ..... 48
- G**
- Glove compartment ..... 95
- H**
- Handbrake ..... 152
- Hangers ..... 96
- Hazard warning lights ..... 80
- Head-on collisions and the laws of physics ... 16
- Head-protection airbags
- safety instructions ..... 25
- Headlights
- change a bulb ..... 49
  - headlight washer ..... 83
  - trips abroad ..... 81
- Headrest ..... 87
- High-voltage battery
- charging cable ..... 170
  - control lamps ..... 160
  - fast charge (DC) ..... 165
  - home charging (wallbox) ..... 166
  - immediate charging and programmed charging ..... 167
  - loading ..... 161
  - socket (AC) ..... 164
  - state of charge ..... 163
  - warnings ..... 158
- Hill driving assistant ..... 143
- Horn ..... 55
- I**
- Ignition ..... 135
- Ignition key extraction lock ..... 135
- Ignition lock ..... 135
- Information for the user ..... 204
- Infotainment System ..... 107
- adapting the playback volume ..... 124
  - anti-theft password ..... 111
  - AUX-IN connection ..... 124
  - Bluetooth ..... 123
  - calling by telephone ..... 127
  - changing station ..... 117
  - Drive Mii App ..... 128
  - energy management ..... 111
  - frequency bands ..... 117
  - frequency change ..... 117
  - general operating information ..... 111
  - Media ..... 120
  - overview of the unit ..... 109
  - preset buttons ..... 118

- radio ..... 115
  - safety instructions ..... 107
  - saving stations ..... 118
  - SD card ..... 122
  - switching Media source ..... 121
  - switching on and off ..... 111
  - tuning station frequency ..... 117
  - USB ..... 123
  - INFO (traffic announcement) ..... 116
  - Inspection ..... 194
  - Instrument panel ..... 56, 57
    - control and warning lamps ..... 65
    - display ..... 57, 59
    - instruments ..... 57
    - service intervals display ..... 63
    - use with the wiper lever ..... 64
  - Instrument panel lighting ..... 81
  - Interior mirror
    - anti-dazzle ..... 84
  - Interior view ..... 9
  - Interlock button ..... 141
  - ISOFIX ..... 30
  - ISOFIX system ..... 30
- J**
- Jack ..... 34
    - position points ..... 40
  - Jump leads ..... 44
  - Jump start ..... 44
    - description ..... 45
- K**
- Keys
    - assign a key ..... 67
    - changing the battery ..... 68
    - duplicates ..... 68
    - mechanical key ..... 68
    - remote control ..... 67
    - spare key ..... 67
    - synchronise ..... 69
    - unlock and lock ..... 70
    - vehicle key ..... 67
  - Key switch ..... 23
- L**
- Lane Assist ..... 148
    - control and warning lamp ..... 148
  - Lane Assist system
    - see Lane Assist ..... 148
  - Leather: clean ..... 199
  - Leaving Home ..... 79
  - Legal provisions ..... 131
  - Levels control ..... 211
  - Lift the vehicle ..... 40
  - Light range control ..... 80
  - Lights ..... 76
    - audible warnings ..... 76
    - AUTO ..... 77
    - change a bulb ..... 49
    - coming home ..... 79
    - control and warning lamps ..... 76
    - control lighting ..... 81
    - controlling the lights ..... 76
    - daylight ..... 77
    - dipped beam headlights ..... 76
  - fog light ..... 78
  - headlight range control ..... 80
  - instrument lighting ..... 81
  - interior lights ..... 81
  - leaving home ..... 79
  - main beam headlights ..... 76, 78
  - reading lights ..... 81
  - side lights ..... 76
  - switch ..... 77
  - switching on and off ..... 77
  - turn signals ..... 78
- Loading the luggage compartment
- bag hooks ..... 92
  - fastening rings ..... 91
  - general advice ..... 89
  - luggage compartment ..... 74, 89
  - positioning the load ..... 89
  - positioning the luggage ..... 89
  - roof carrier system ..... 93
- Load on the roof ..... 93
  - technical data ..... 93
- Lock and unlock
- luggage compartment ..... 74
  - with the central locking switch ..... 71
- Luggage compartment ..... 74, 89
  - closing ..... 74
  - emergency unlocking ..... 75
  - luggage compartment lighting ..... 81
  - storing the rear shelf ..... 90
  - variable luggage compartment floor ..... 91
- Luggage compartment floor ..... 91
- Luggage compartment shelf
  - storing ..... 90
- Lumbar support ..... 86

**M**

Main beam headlight lever .....	78
Maintenance	
see Service .....	194
Mats .....	13
Media .....	120
External data storage device connected to a USB port .....	123
smartphone .....	128
MFD	
see Multifunction display .....	61
Mirrors .....	84
adjusting the exterior mirrors .....	85
anti-dazzle interior .....	84
see also Mirrors .....	84
Mobile phone .....	125, 202
Multifunction display .....	61

**N**

Navigation	
smartphone .....	128
Noise	
brakes .....	150
ESC .....	154
tyres .....	187, 191
Number of seats .....	12

**O**

Odometer	
partial .....	57
total .....	57
Opening .....	69
bonnet .....	177
windows .....	75

Opening and closing .....	69
bonnet .....	177
by remote control .....	70
doors .....	72
rear lid .....	74
windows .....	75
with the central locking switch .....	71
Operation in winter	
battery .....	182
salt on the roads .....	84
snow chains .....	192
tyres .....	191
Optical parking system (OPS) .....	156
Original SEAT Spare Parts .....	195
Overseas	
longer stay with the vehicle .....	205
selling the vehicle .....	205
Overview (left hand drive) .....	8

**P**

Painting the vehicle	
care .....	198
Parking .....	154
Parking aid .....	156
optical parking system (OPS) .....	156
sensors and camera: clean .....	198
Parking aid system	
see Parking aid .....	156
Parking distance warning system .....	155
fault .....	156
see also Parking aid .....	156
ParkPilot	
see Parking aid .....	156
Pedals .....	11, 13
Power display and available power .....	57

Power socket .....	97
12 Volts .....	97
Power steering	
see Electromechanical steering .....	143
Power windows .....	75

**R**

Radio	
main menu .....	115
station name .....	115
Radio-operated remote control	
see Keys .....	67
Radio reception	
antenna .....	206
malfunctions .....	206
Radio telephones .....	202
Rain sensor .....	83
function control .....	84
Raise the vehicle .....	40
RDS .....	115
TP (traffic information station) .....	116
Rear fog light	
control lamp .....	76
Rear lid .....	74
emergency closing and opening .....	75
Rear seat	
folding down and raising the backrest .....	88
Rear windows .....	76
Rear window wiper .....	82
Recycling .....	206
Releasing the seat belt .....	17
Repairs .....	206
Repair work .....	202
Reprogramming of control units .....	204
Reverse (automatic gearbox) .....	140

- Revolution counter ..... 57
- Roof carrier ..... 92
  - fix the crossbars ..... 93
- Roof carrier system ..... 92
- Roof rack ..... 92
- Rotation direction
  - tyres ..... 42
- Running in
  - new brake pads ..... 150
  - new engine ..... 145
  - new tyres ..... 186
- S**
- Safe ..... 139
- Safe driving ..... 10
- Safe security system ..... 71
- Safety
  - child safety ..... 26
  - child seats ..... 26
  - safe driving ..... 10
- Safety equipment ..... 11
- Safety instructions
  - Head-protection airbags ..... 25
  - seat belt tensioners ..... 19
  - side airbags ..... 24
  - using child seats ..... 28
  - using seat belts ..... 15
- Scrapping ..... 206
- Screen ..... 57, 59
  - clean ..... 199
- SD card ..... 122
- Seat belts ..... 14
  - adjustment ..... 17
  - control lamp ..... 14
  - fitting the seat belt strap ..... 18
  - protective function ..... 15
  - purpose ..... 14, 20
  - safety instructions ..... 15
  - unfastened ..... 16
- Seat belt tensioners ..... 19
  - control lamp ..... 22
- SEAT CONNECT
  - activation ..... 131
  - deactivate ..... 132
  - faults ..... 132
  - legal provisions ..... 131
- Seat heating ..... 103
- SEAT information system ..... 63
- Seats
  - backrest of the rear seat ..... 88
  - heating ..... 103
  - incorrect positions ..... 12
  - manual adjustment ..... 86
  - number of seats ..... 12
- SEAT Service Mobility ..... 195
- Selective unlocking system ..... 70
- Selector lever lock ..... 141
- Selector lever (automatic gearbox)
  - positions ..... 140
- Selling the vehicle ..... 131
  - in other countries/continents ..... 205
- Service
  - Digital Maintenance plan ..... 194
  - inspection ..... 194
  - proof of Service ..... 194
  - service works ..... 194
  - set service intervals ..... 194
  - terms of use ..... 195
- Service interval display ..... 194
- Service intervals ..... 63
- Set of vehicle keys ..... 67
- Side airbags
  - safety instructions ..... 24
- Smartphone ..... 128
- Smartphone support
  - removing and attaching ..... 98
- Snow chains ..... 192
- Spare parts ..... 202
- Special characteristics
  - towing ..... 46
  - tow start ..... 46
- Speed symbol ..... 187
- Start the engine by towing ..... 46
  - special characteristics ..... 46
- Stationary air conditioning ..... 104
  - connecting ..... 104
  - programming ..... 106
- Status display ..... 59
  - doors, bonnet and rear lid open ..... 59
  - driving profiles ..... 144
  - odometer ..... 59
  - reminder ..... 63
  - seat belt status ..... 60
  - selector lever positions ..... 60, 140
  - service intervals ..... 63
  - temperature ..... 60
  - warning and information messages ..... 62
- Steering wheel
  - adjust ..... 13
- Stickers and plates ..... 205
- Storage compartment ..... 94
  - front centre console ..... 95
  - glove compartment ..... 95
  - glove compartment light ..... 81
  - on-board documentation ..... 95

- on the front passenger side ..... 95
  - other object holders ..... 96
  - Storage compartment accessories
    - see Storage ..... 94
  - Storage of trip data ..... 204
  - Storing objects ..... 89
    - fastening rings ..... 91
    - positioning the load ..... 89
    - positioning the luggage ..... 89
    - roof carrier ..... 92
    - roof carrier system ..... 92, 93
    - trailer ..... 157
  - sun blind ..... 85
  - Sun protection ..... 85
- T**
- Tail lights
    - change a bulb ..... 49
  - Technical data ..... 211
    - load on the roof ..... 93
    - vehicle dimensions ..... 213
    - weights ..... 211
  - Technical modifications ..... 202
  - Telephone
    - Bluetooth ..... 125
    - favourites ..... 127
    - functions ..... 126
    - to call ..... 127
  - To change the battery
    - of the vehicle key ..... 68
  - To park the vehicle ..... 154
  - Top Tether ..... 30, 32
  - Top Tether System ..... 30, 32
  - Torque
    - wheel nuts ..... 42
  - Towing bracket device
    - description ..... 157
  - Towing the vehicle ..... 46
    - front towline anchorage ..... 46
    - special characteristics ..... 46
  - TP (traffic information) ..... 116
    - traffic announcement (INFO) ..... 116
  - Traction control system ..... 153
  - traffic announcement (INFO TP) ..... 116
  - Trailer ..... 157
  - Trailer mode
    - see Trailer ..... 157
  - Transportation of children ..... 26
  - Trips abroad
    - headlights ..... 81
  - Turning off the lights ..... 76
  - Turning on the lights ..... 76
  - Turning the ignition on and off ..... 135
  - Turn signal lever ..... 78
  - Turn signals
    - Comfort function ..... 78
  - Type plate ..... 211
  - Tyre Mobility System
    - see Anti-puncture kit ..... 35
  - Tyre pressure ..... 188
  - Tyre pressure monitor system
    - control lamp ..... 192
  - Tyre profile ..... 190
  - Tyre repair kit ..... 34
    - see also Anti-puncture kit ..... 35
  - Tyre repairs ..... 35
  - Tyres ..... 186
    - accessories ..... 187
    - change ..... 38
    - directional tread pattern ..... 42
    - foreign objects inserted ..... 187
    - new tyres ..... 187
    - speed symbol ..... 187
    - tread wear indicators ..... 190
    - tyre pressure ..... 188
    - useful life ..... 188
    - with directional tread pattern ..... 187
  - Tyre tread depth ..... 190
  - Tyre wear ..... 190
- U**
- Unlock and lock
    - by remote control ..... 70
    - doors ..... 72
    - with the central locking switch ..... 71
  - USB
    - connecting external data media ..... 123
    - location ..... 97
    - USB connection ..... 97
- V**
- Vanity mirror ..... 85
  - Variable luggage compartment floor ..... 91
  - Vehicle
    - identification number ..... 211
    - lending or selling ..... 131
    - parking on inclines ..... 154
    - parking on upward slopes ..... 154
    - raise ..... 40
    - recycling ..... 206
    - type plate ..... 211
  - Vehicle care
    - wiper blade service position ..... 43
  - Vehicle conservation products ..... 196



- Vehicle dimensions ..... 213
- Vehicle location ..... 131
- Vehicle maintenance ..... 196
- antenna built into the glass ..... 206
  - see also *Cleaning the vehicle* ..... 196
- Vehicle seats ..... 12
- Vehicle tool kit ..... 34
- Vehicle wallet compartment ..... 95
- W**
- Wallbox ..... 166
- Warning symbols
- see *Control and warning lamps* ..... 65
- Warning triangle ..... 34, 80
- Warranty ..... 196
- Washing the vehicle
- conserving the exterior of the vehicle ..... 197
  - high pressure cleaning equipment ..... 197
  - sensors ..... 155
- Weights ..... 211
- Wheel balance ..... 188
- Wheel bolts ..... 39, 190
- anti-theft device ..... 39
  - caps ..... 38
  - torque ..... 42
- Wheels ..... 186
- change ..... 38, 41
  - changing ..... 190
  - changing a wheel ..... 38
  - new wheels ..... 187
  - snow chains ..... 192
  - wheel trim ..... 38
- Wheel spanner ..... 34
- Wheel trim ..... 38
- remove ..... 38
- Window controls ..... 75
- Window washer
- window washer lever ..... 82
- Window washer system ..... 181
- Window washer water
- check ..... 181
  - filling quantities ..... 181
  - refill ..... 181
- Windscreen
- heat-insulating glass ..... 86
  - infrared protection ..... 86
- Windscreen heating ..... 101
- Windscreen washer ..... 82
- Windscreen wipers ..... 82
- functions ..... 83
  - headlight washer system ..... 83
  - lift the blade ..... 43
  - rain sensor ..... 83
  - reposition the blade ..... 43
  - service position ..... 43
  - special characteristics ..... 83
  - thermal washing ejectors ..... 83
- Winter tyres ..... 191
- Wiper and rear window wiper blades
- cleaning ..... 43
  - replacement ..... 43
  - service position ..... 43
- Wiper blades
- cleaning ..... 198



SEAT S.A. is permanently concerned about continuous development of its types and models. For this reason we ask you to understand, that at any given time, changes regarding shape, equipment and technique may take place on the car delivered. For this reason no right at all may derive based on the data, drawings and descriptions in this current handbook.

All texts, illustrations and standards in this handbook are based on the status of information at the time of printing. Except for error or omission, the information included in the current handbook is valid as of the date of closing print.

Re-printing, copying or translating, whether total or partial is not allowed unless SEAT allows it in written form.

SEAT reserves all rights in accordance with the "Copyright" Act.

All rights on changes are reserved.

 This paper has been manufactured using bleached non-chlorine cellulose.

© SEAT S.A. - Reprint: 15.08.20

Inglés 12S012720BB (08.20)



12S012720BB

