



Owner's manual **SEAT Toledo**



Vehicle identification data

Model:
Vehicle Registration:
Vehicle identification number:
Date of vehicle registration or vehicle delivery:
SEAT Official Service:
Service advisor:
Telephone:

Confirmation of receipt of documentation and vehicle keys

The following items were delivered with the vehicle:	YES	NO
On-board documentation	<input type="checkbox"/>	<input type="checkbox"/>
First key	<input type="checkbox"/>	<input type="checkbox"/>
Second key	<input type="checkbox"/>	<input type="checkbox"/>
Correct working order of all keys was checked	<input type="checkbox"/>	<input type="checkbox"/>
Location:		
Date:		
Signature of owner:		

Introduction

Thank you for your trust choosing a SEAT vehicle.

With your new SEAT, you will be able to enjoy a vehicle with state-of-the-art technology and top quality features.

We recommend reading this Instruction Manual carefully to learn more about your vehicle so you can enjoy all its benefits in your daily driving.

Information about handling is complemented with instructions regarding the operation and maintenance of the vehicle in order to ensure its safety and maintain its value. Moreover, we want to give you valuable advice and tips to drive your vehicle efficiently and respecting the environment.

We wish you safe and enjoyable motoring.

SEAT, S.A.

WARNING

Read and always observe safety information concerning the passenger's front airbag »» page 75, Important information regarding the front passenger's airbag.

About this manual

This manual describes the **features** of the vehicle at the time of drafting this text. Some of the features described below will be introduced in the future or will only be available in certain markets.

Some of the features described here are not included in all the types or variations of the model and they can be varied or modified based on technical or marketing requirements without it being considered misleading advertising.

Some details on the **drawings** may vary from its vehicle and must be interpreted as a standard representation.

The **direction indicators** (left, right, forwards, backwards) in this manual refer to the travel direction of the vehicle unless otherwise stated.

The **audiovisual material** is only meant to help the users better understand some features of the car. It is not a replacement for the instruction manual. Access the instruction manual to see the complete information and warnings.

★ The **features marked with an asterisk** are included by default only in certain versions of the model, supplied as optional only for certain versions or only offered in certain countries.

® **Trademarks** are marked with ®. The absence of this symbol does not guarantee that the term is not a trademark.

>> It indicates that the section continues on the next page.

⚠ Important warnings on the page.

📖 More in-depth content on the page.

📄 General information on page indicated.

SOS Emergency information on the page.

You can access the information in this manual using:

- Thematic table of contents that follows the manual's general chapter structure.
- Visual table of contents that uses graphics to indicate the pages containing "essential" information, which is detailed in the corresponding chapters.
- Alphabetical index with many terms and synonyms to help you find information.

⚠ WARNING

Texts after this symbol contain information about safety and warn you about possible accident or injury risks.

ⓘ CAUTION

Texts after this symbol indicate possible damage to the vehicle.

♻ For the sake of the environment

Texts after this symbol contain information about the protection of the environment.

📄 Note

Texts after this symbol contain additional information.

Printed Instruction Manual

The printed instruction manual contains relevant information about the use of the vehicle and the Infotainment System.

The digital version of the manuals contains more in-depth information.

Digital Version of the Infotainment System Manual



The digital version is available on SEAT's official website.

To view the digital version of the manual:

- scan the QR code »» Fig. 1
- **OR** enter the following address in the navigator website:

<http://www.seat.com/owners/your-seat/manuals-offline.html>

choose your vehicle and then "Infotainment".

Related videos



The operation of some of the vehicle's features can be shown as an instruction video:

- scan the QR code »» Fig. 2
- **OR** enter the following address in the navigator website:

<http://www.seat.com/owners/your-seat/manuals-offline.html>

choose your vehicle and then "Multimedia".

Note

Video instructions are only available in certain languages.

Frequently Asked Questions

Before driving

How do you adjust the seat? » page 14

How do you adjust the steering wheel?
» page 16

How do you adjust the exterior mirrors?
» page 15

How do you turn on the exterior lights?
» page 21

How does the automatic gearbox selector lever work? » page 36

How do you refuel? » page 41

How do you activate the windscreen wipers and windscreen washer system? » page 23

Emergency situations

A warning lamp lights up or flashes. What does this mean? » page 34

Where are the first-aid kit and the warning triangle in the vehicle? » page 78

How do you open the bonnet? » page 13

How do you perform a jump start? » page 54

Where is the vehicle tool kit located?
» page 48

How do you repair a tyre with the anti-puncture kit? » page 47

How do you change a wheel? » page 48

How do you change a fuse? » page 45

How do you change a light? » page 46

How do you tow a vehicle? » page 52

Useful tips

How do you set the time? » page 99

When should the vehicle inspection should be performed? » page 33

What functions do the buttons/thumbwheels on the steering wheel perform? » page 103

How do you drive in an economical and environmentally-friendly way? » page 211

How do you check and top up the engine oil?
» page 42

How do you check and top up the engine coolant? » page 43

How do you top up the windscreen washer fluid?
» page 44

How do you check and top up the brake fluid?
» page 43

How do you check and adjust tyre pressure values? » page 256

Vehicle washing tips » page 265

Functions of interest

Easy Connect, CAR menu » page 24

How does the START-STOP system work?
» page 215

What parking assistants are available?
» page 222

How does the rear assist work? » page 227

How does tyre pressure monitoring work?
» page 260

How do you open the vehicle without a key [Keyless Access]? » page 113

Interior lighting and ambient light » page 126

Table of Contents

The essentials	7	Safety	57	Operation	97
Exterior view	7	Safe driving	57	Controls and displays	97
Exterior view	8	Advice about driving	57	General instrument panel	96
Interior view (left-hand drive)	9	Correct position of the vehicle occupants	58	Instruments and warning lamps	98
Interior view (steering wheel on the right)	10	Pedal area	62	Instruments	98
How it works	11	Seat belts	63	Control lamps	103
Unlocking and locking	11	The whys and wherefores of seat belts	63	Multi-function steering wheel*	103
Before driving	14	How to properly adjust your seat belt	66	Opening and closing	108
Airbags	16	Seat belt tensioners	67	Remote control	108
Child seats	19	Airbag system	68	Keys	109
Starting the vehicle	20	Brief introduction	68	Central locking system	110
Lights and visibility	21	Airbag safety instructions	70	Anti-theft alarm*	116
Easy Connect	24	Deactivating airbags	72	Rear lid	117
Driver information system	27	Transporting children safely	75	Controls for the windows	119
Status display	31	Safety for children	75	Lights and visibility	120
Cruise control	34	Child seats	76	Lights	120
Warning lamps	34	Emergencies	78	Interior lights	126
Gearbox lever	36	Self-help	78	Visibility	127
Air conditioning	37	Emergency equipment	78	Windscreen wipers and windscreen washers	128
Fluid level control	41	Changing a wheel	78	Mirrors	130
Emergencies	45	Tyre repairs	79	Seats and head restraints	131
Fuses	45	Towing the vehicle	81	Adjusting seats and head restraints	131
Bulbs	46	Fuses and bulbs	83	Seat functions	132
Action in the event of a puncture	46	Fuses	83	Transport and practical equipment	135
Changing a wheel	48	Changing bulbs	86	Practical equipment	135
Snow chains	52	Changing the fog light bulbs	90	Storing objects	141
Emergency towing of the vehicle	52	Changing the rear lights (on the side panel)	90	Luggage compartment	142
How to jump start	54	Changing the rear lights (on the side panel)	90	Roof rack*	145
Changing the windscreen wiper blades	56	Changing tail lights (on the rear lid)	92	Air conditioning	146
		Changing the side and number plate bulbs	94	Heating and air conditioning	146
				Heating and fresh air	148
				Air conditioning [manual]*	149
				Climatronic* [automatic air conditioning]	151

Infotainment System	154	Rear Assist "Rear View Camera"*	227	Information for the user	271
Introduction	154	Fatigue detection (break recommendation)*	230	Information for the user	271
Safety warnings	154	Towing bracket device	232	Important information	271
Overview of the unit	156	Driving with a trailer	232	Information about the EU Directive 2014/53/EU	271
General instructions for use	158	Towing bracket device	234	Technical data	275
Connectivity	163	Practical tips	240	Technical specifications	275
Data transfer	163	Accessories and modifications to the vehicle	240	Important information	275
Full Link*	163	Accessories and modifications to the vehicle	240	Information on fuel consumption	276
Operating modes	171	Checking and refilling levels	241	Driving with a trailer	277
Radio	171	Fuel	241	Wheels	277
Media	172	Engine compartment	244	Engine data	279
Navigation	178	Engine oil	247	Vehicle data	281
Vehicle Menu	188	Coolant	248	Index	283
Telephone	189	Brake fluid	250		
Multimedia	195	Window washer system	251		
Driving	196	Battery	251		
Start and driving	196	Wheels and tyres	255		
Starting and stopping the engine	196	Tyres	255		
Brakes and brake servo systems	199	Spare wheel	259		
Braking and stability systems	201	Tyre monitoring system	260		
Manual gearbox	203	Winter service	261		
Automatic gearbox	203	Maintenance	262		
Gear-change indicator	208	Service	262		
Steering	209	Service intervals	262		
Run-in and economical driving	210	Additional service offers	264		
Engine management and emission control system	213	Warranty	265		
Driving tips	214	Vehicle maintenance	265		
Driver assistance systems	215	Maintenance and cleaning	265		
Start-Stop system*	215				
Cruise control (CCS)*	217				
Emergency braking assistance system (Front Assist)*	219				
Parking aid	222				

Exterior view

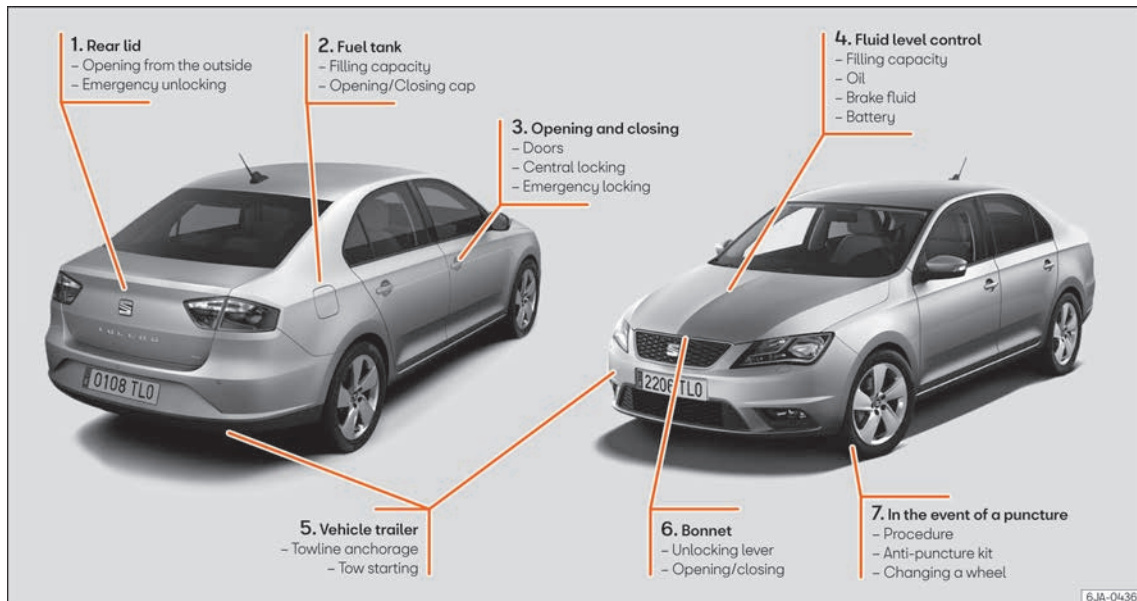

① »» page 12

② »» page 41

③ »» page 11

④ »» page 41

⑤ »» page 52

⑥ »» page 13

⑦ »» page 46

Exterior view

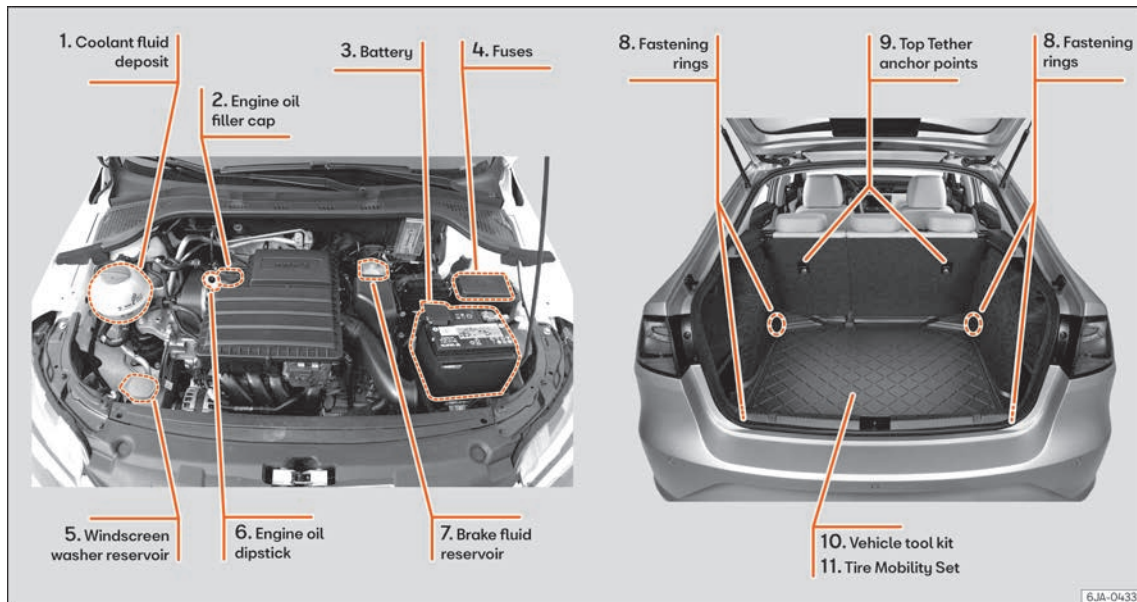

6JA-0433

① »» page 43

② »» page 42

③ »» page 44

④ »» page 45

⑤ »» page 44

⑥ »» page 42

⑦ »» page 43

⑧ »»  page 141

⑨ »» page 20

⑩ »» page 48

⑪ »» page 47

Interior view (left-hand drive)

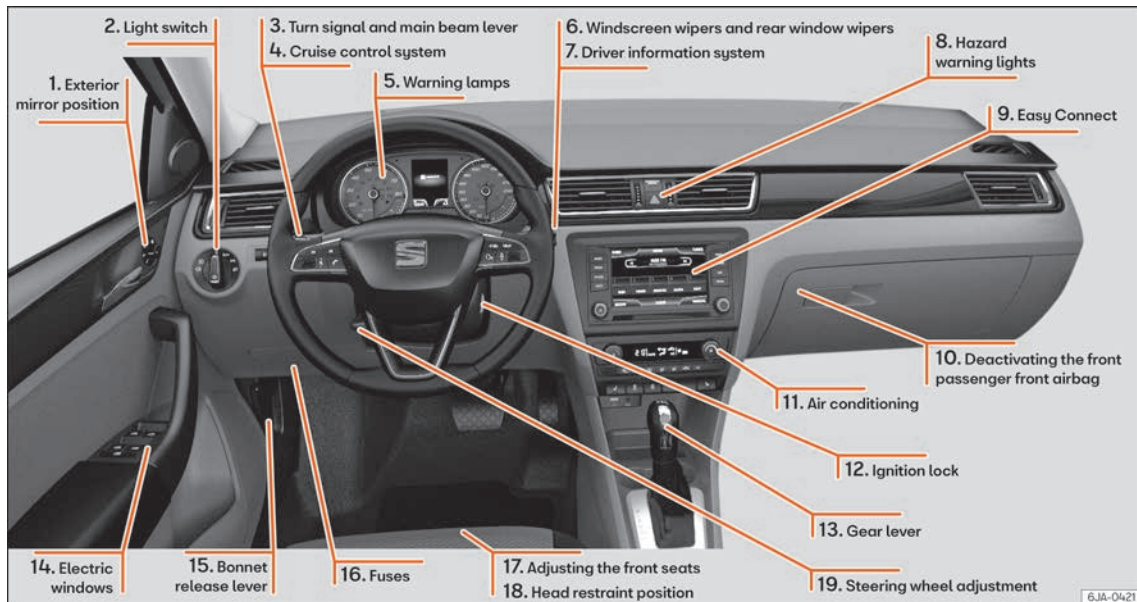

- ① » page 15
- ② » page 21
- ③ » page 21
- ④ » page 34

- ⑤ » page 34
- ⑥ » page 23
- ⑦ » page 27
- ⑧ » page 22

- ⑨ » page 24
- ⑩ » page 17
- ⑪ » page 37
- ⑫ » page 20

- ⑬ » page 36
- ⑭ » page 14
- ⑮ » page 13
- ⑯ » page 45

- ⑰ » page 14
- ⑱ » page 14
- ⑲ » page 16

Interior view (steering wheel on the right)

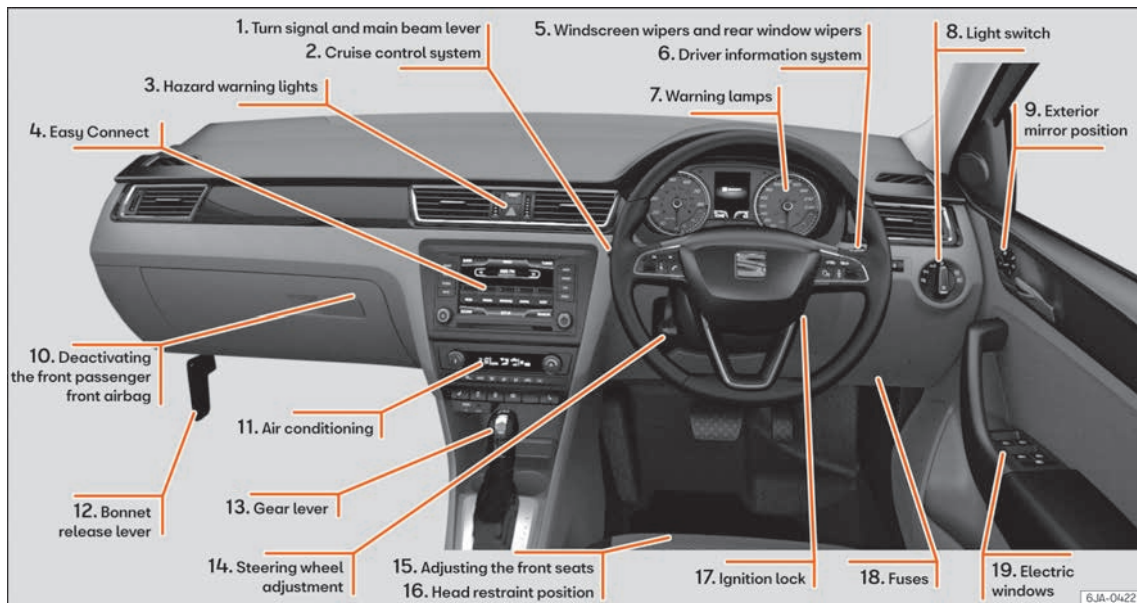

- ① » page 21
- ② » page 34
- ③ » page 22
- ④ » page 24

- ⑤ » page 23
- ⑥ » page 27
- ⑦ » page 34
- ⑧ » page 21

- ⑨ » page 15
- ⑩ » page 17
- ⑪ » page 37
- ⑫ » page 13

- ⑬ » page 36
- ⑭ » page 16
- ⑮ » page 14
- ⑯ » page 14

- ⑰ » page 20
- ⑱ » page 45
- ⑲ » page 14

6JA-0422

How it works

Unlocking and locking

Doors





Fig. 3 Remote control key: keys.





Fig. 4 Centre console: central locking switch.

Locking and unlocking the vehicle using the key

- Locking: press the button  » **Fig. 3**.
- Unlocking: press the button  » **Fig. 3**.
- Unlock rear lid: press the  » **Fig. 3** button until all the turn signals on the vehicle briefly light up.

Locking and unlocking with the central locking switch

- Locking: press the button  » **Fig. 4**. The warning lamp on the button will light up. None of the doors can be opened from the outside. The doors can be opened from the inside by pulling the inside door handle.
- Unlocking: press the button  » **Fig. 4**. The warning lamp on the button will switch off.



»  in **Unlocking and locking the vehicle** on page 109



» page 108

SOS

» page 11, » page 12

Unlocking or locking of driver door

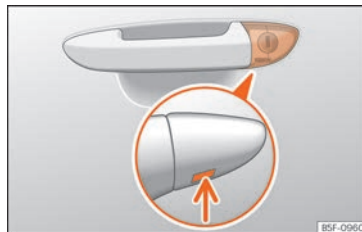



Fig. 5 Driver door lever: hidden lock cylinder.

If the central locking system should fail to operate, the driver door can still be locked and unlocked by turning the key in the lock.

- Unfold the vehicle key shaft.
- Insert the key shaft into the lower opening in the cover on the driver door handle » **Fig. 5** (arrow) then remove the cover upwards.
- Insert the key blade into the lock cylinder to unlock or lock the vehicle.

Special characteristics

- The anti-theft alarm will remain active when vehicles are unlocked. However, it is not triggered »  **page 110**.
- After the driver door is opened, you have 15 seconds to switch on the ignition. Once this time has elapsed, the alarm is triggered. »

- Switch the ignition on. The electronic immobilizer recognises a valid vehicle key and deactivates the anti-theft alarm system.

i Note

The anti-theft alarm is not activated when the vehicle is locked manually using the key shaft »»  page 110.

Locking manually

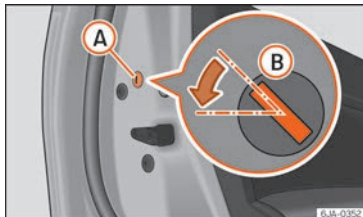

Fig. 6 Rear door: emergency lock.

On the front of a door with no lock cylinder there is an emergency locking device that is only visible when the door is open.

Locking

- Remove the cap **A** »» **Fig. 6**.
- Insert the key in the slot **B** and turn it in the direction of the arrow until horizontal (on the other direction on the right-hand door).

- Replace the cap.

Once the door has been locked, it can no longer be opened from the outside. The door can be opened again from the inside by pulling the door handle.

Rear lid

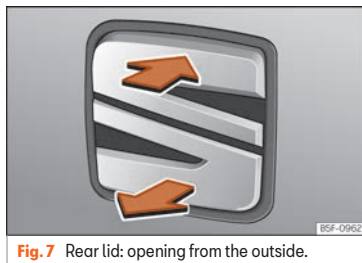



Fig. 7 Rear lid: opening from the outside.

- Opening the rear lid: pull on the release lever and lift it up »» **Fig. 7**. The rear lid opens automatically.
- Close the rear lid: hold it by one of the handles on the interior lining and close it by pushing gently.



»»  in Opening and closing on page 118



»» page 117

SOS

»» page 12

Manual release mechanism for the rear lid



Fig. 8 Luggage compartment: access to manual release.

The rear lid can be unlocked manually from inside in the event of an emergency.

- Insert the key in the opening in the lining of the rear lid and move the key in the direction of the arrow until the lock is released.

Bonnet

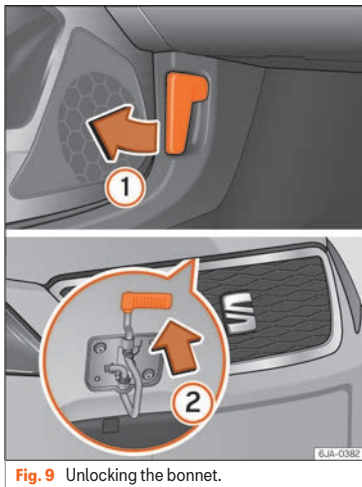

Fig. 9 Unlocking the bonnet.

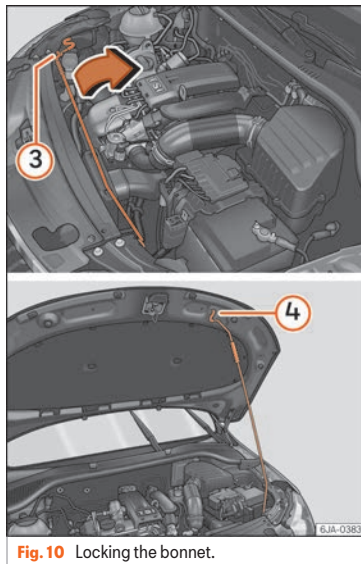

Fig. 10 Locking the bonnet.

Opening the bonnet

The bonnet is released from inside the vehicle.

Before opening the bonnet, make sure that the windscreen wiper arms are in place against the windscreen.

- Open the door and pull the lever under the dashboard »» Fig. 9 ①.
- To lift the bonnet: press the release catch under the bonnet upwards ②. The arrester hook under the bonnet is released.
- The bonnet can be opened. Release the bonnet stay in the direction of the arrow »» Fig. 10 ③ and secure it in the fixture designed for this in the bonnet ④.

Closing the bonnet

- Slightly lift the bonnet.
- Release the bonnet stay and replace it in its support.
- At a height of approximately 30 cm let it fall so it locks.

If the bonnet does not close, do not press downwards. Open it again and let it fall as mentioned above.



»» ⚠ in Working in the engine compartment on page 245



»» page 244

Controls for the windows*

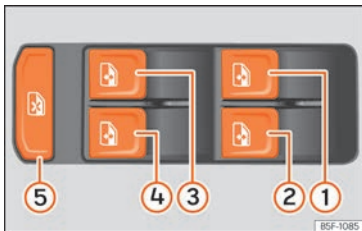



Fig. 11 Detail of the driver door: controls for the windows.

- Opening the window: press the button 
- Closing the window: pull the button 

Buttons on the driver door

- ① Window on the front left door
- ② Window on the front right door
- ③ Window on the rear left door
- ④ Window on the rear right door
- ⑤ Safety switch for deactivating the electric window buttons in the rear doors.



»» »  in Operation of the electric windows on page 119



»» » page 119

Before driving

Manually adjusting the front seats

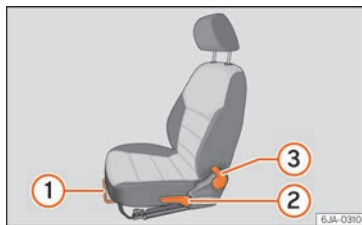

Fig. 12 Front seats: manual seat adjustment.

- ① Forwards/backwards: pull the lever and move the seat.
- ② Raising/lowering: pull/push the lever.
- ③ Tilt backrest: pull the lever back.



»» »  in Introduction on page 131

Adjusting the head restraints

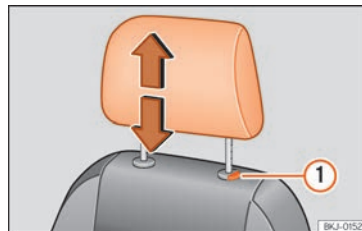

Fig. 13 Front seat: adjusting the head restraint.

Grab the sides of the head restraints with both hands and push upwards to the desired position. To lower it, repeat the same action, pressing the ① button on the side.



»» »  in Head restraints on page 132



»» » page 61, »» » page 132

Adjustment of the seat belt

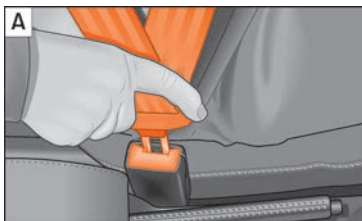

Fig. 14 Positioning and removing the seat belt buckle.

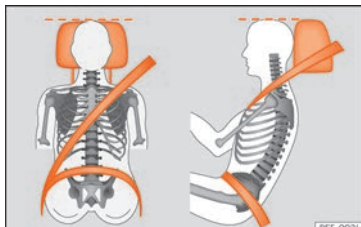

Fig. 15 Correct seat belt and head restraint positions, viewed from front and the side.

To adjust the seat belt around your shoulders, adjust the height of the seats.

The shoulder part of the seat belt should be well centred over it, never over the neck. The seat belt lies flat and fits comfortably on the upper part of the body.

The lap part of the seat belt lies across the pelvis, never across the stomach. The seat belt lies flat and fits comfortably on the pelvis.



»» page 64



»» page 66

Seat belt tensioners

During a collision, the seat belts on the front seats are retracted automatically.

The tensioner can be triggered only once.



»» ⚠ in Maintenance and disposal of belt tensioners on page 68



»» page 67

Adjusting the exterior mirrors

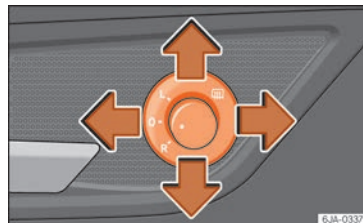

Fig. 16 Detail of the driver door: control for the exterior mirror.

Adjusting the exterior mirrors: Turn the knob to the corresponding position:

L/R Turning the knob to the desired position, adjust the mirrors on the driver side (L, »

left) and the passenger side (R, right) to the direction desired.

- Depending on the equipment fitted on the vehicle, the mirrors may be heated according to the outside temperature.



» » » ⚠ in Exterior mirrors on page 130



» » » page 130

Adjusting the steering wheel

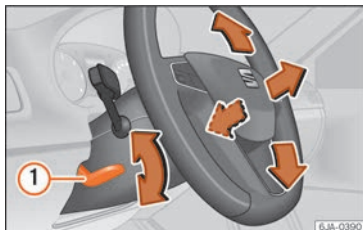

Fig. 17 Lever in the lower left side of the steering column.

Adjusting the position of the steering wheel: pull the » » » **Fig. 17** ① lever down, move the steering wheel to the desired position and lift the lever back up until it locks.



» » » ⚠ in Adjusting the steering wheel position on page 59

Airbags

Front airbags



Fig. 18 Driver airbag in the steering wheel and front passenger airbag in the dash panel

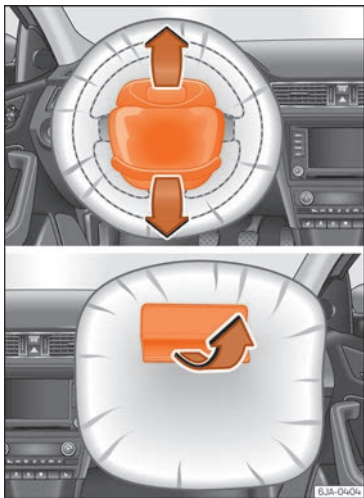

Fig. 19 Airbag covers reacting when the front airbags are triggered.

The front airbag for the driver is located in the steering wheel »» Fig. 18 [A] and the front passenger airbag is located in the dash panel »» Fig. 18 [B]. Airbags are identified by the word "AIRBAG".

When the driver and front passenger airbags are deployed, the covers remain attached to the steering wheel and dashboard, respectively »» Fig. 19.

In conjunction with the seat belts, the front airbag system gives the driver and the front passenger additional protection for the head and chest in the event of a severe frontal collision.

Their special design allows the controlled escape of the propellant gas when an occupant puts pressure on the bag. Thus, the head and chest are protected by the airbag. After the collision, the airbag deflates sufficiently to allow visibility.



»» ⚠ in Front airbags on page 70

Deactivating the front passenger front airbag



Fig. 20 Front passenger front airbag switch.

To deactivate the front passenger front airbag:

- Open the glove compartment on the front passenger side.
- Insert the key blade into the slot provided in the deactivation switch.
- Approximately $\frac{3}{4}$ of the length of the key blade remains inserted (the maximum).
- Turn the key blade, changing its position to **OFF**. Do not force it. If you have difficulty, ensure that you have inserted the key as far as it will go.
- Finally, check the control lamp on the instrument panel where it shows **PASSENGER AIR BAG OFF** ⚠; the following should appear **OFF**.



»» ⚠ in Switch front passenger front airbag on and off on page 73



»» page 73

Side airbags*

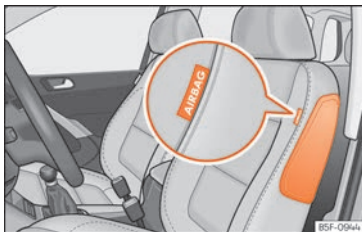

Fig. 21 Side airbag in driver's seat.

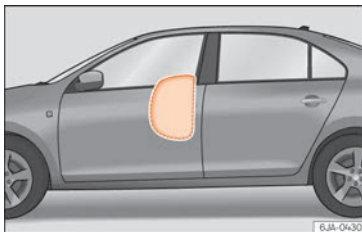

Fig. 22 Illustration of completely inflated side airbag on left side of vehicle.

The side airbags are located in the driver's seat and front passenger seat backrests » **Fig. 21**. The locations are identified by the text "AIRBAG" in the upper region of the backrests.

In conjunction with the seat belts, the side airbag system provides additional protection for the upper body in the event of a severe side collision » **Fig. 20**, **page 63, The whys and wherefores of seat belts.**

In a side collision, the side airbags reduce the risk of injury to passengers to the areas of the body facing the impact. In addition to the normal protection from the front seat belts, passengers are also held fast in the event of a side collision, and this is how these airbags provide maximum protection.



» **Fig. 21** in Side airbags* on page 71

Head-protection airbags*



Fig. 23 Location of head-protection airbags.



Fig. 24 Deployed head-protection airbags.

The head-protection airbags are located on both sides in the interior above the doors » **Fig. 23** and are identified with the text "AIRBAG".

In conjunction with the seat belts, the head-protection airbag system gives the vehicle occupants additional protection for the head and upper body in the event of a severe side collision » **page 18.**



» **Fig. 23** in Head-protection airbags* on page 71

Child seats

Important information regarding the front passenger's airbag



Fig. 25 Passenger side sun blind.

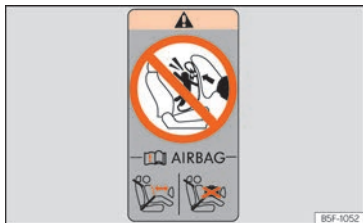

Fig. 26 On the rear frame of the passenger side door: adhesive in relation to the airbag.

A sticker with important information about the passenger airbag is located on the passenger's sun visor and/or on the passenger side door frame.



» » » ⚠ in Important information regarding the front passenger's airbag on page 75



» » » page 75

Possible ways to secure child seats

You can secure a child seat to the rear seat or front passenger seat in the following ways:

- Child seats in groups **0 to 3** can be secured with a seat belt.
- Child seats for groups **0, 0+ and 1** can be fastened without seat belts, using the "ISO-FIX" and Top Tether* system, using the "ISO-FIX" and Top Tether* securing rings

» » » page 20.

Weight group	Seat locations		
	Front passenger ^{a)}	Rear outer	Rear centre
Group 0 <10 kg	U ^{b)}	U/L	U
Group 0+ <13 kg	U ^{b)}	U/L	U
Group 1 9-18 kg	U ^{b)}	U/L	U

Weight group	Seat locations		
	Front passenger ^{a)}	Rear outer	Rear centre
Group II/III 15-36 kg	U ^{b)}	U	U

U: Suitable for universal approved restraining systems for use in this age category (universal retention systems are those fitted using the adult seat belt).
L: Suitable for retention systems using the "ISOFIX" and Top Tether* anchors.

^{a)} Compliance with current national legislation and the manufacturer's instructions is required when using or installing child seats.

^{b)} Move the front passenger seat as far back as possible, as high as possible and always disable the airbag.

The systems include the child restraint system mounting with an upper retaining strap (Top Tether) and lower anchoring points on the seat.



» » » ⚠ in Safety instructions on page 76

Securing child seats with “ISOFIX” and Top Tether*



Fig. 27 ISOFIX securing rings.

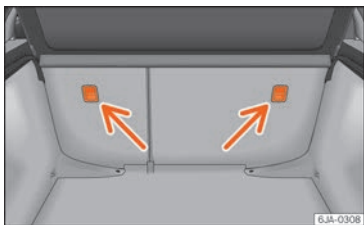

Fig. 28 Top Tether* securing ring.

Child seats with the “ISOFIX” or Top Tether* system can be secured quickly, easily and safely on the rear outer seats.

When removing or fitting the child seat, please be sure to follow the manufacturer's instructions.

- Move the rear seat as far to the rear as it will go.
- Press the child seat onto the “ISOFIX” retaining rings until the child seat can be heard to engage. If the child seat is equipped with Top Tether* anchor points, secure it to the correspondent ring. Observe the manufacturer's instructions.
- Pull on both sides of the child seat to ensure that it is secure.

Two “ISOFIX” retaining rings are fitted on both outermost rear seats. In some vehicles, the rings are secured to the seat frame and, in others, they are secured to the rear floor. Access to the “ISOFIX” rings is between the rear seat backrest and the seat cushioning. The Top Tether* rings are located at the rear of the backrests of the rear seats (behind the seat backrest or in the boot).

Child seats with the “ISOFIX” and Top Tether* attachment system are available from Technical Services.



»» »  in Safety instructions on page 76

Starting the vehicle

Ignition lock

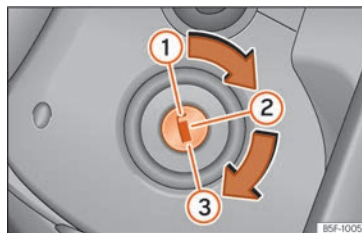

Fig. 29 Ignition key positions.

Turn on the ignition: place the key in the ignition and start the engine.

Locking and unlocking the steering wheel

- Lock the steering wheel: remove the key from the ignition and turn the wheel until it locks. In vehicles with automatic transmission, in order to remove the key, move the gear shift to the **P** position. If necessary, press the gear shift blocking key and release it.
- Unlock the steering wheel: put the key into the ignition and turn it at the same time as the steering wheel in the direction indicated by the arrow. If it is not possible to turn the steering wheel, it may be because it is locked.

Turning on/switching off the ignition, glow plugs reheating

- Turn on the ignition: turn the key to the ② position.
- Turn off the ignition: turn the key to the ① position.
- Diesel vehicles ∞ : the glow plugs reheat when the ignition is switched on.

Starting the engine

- Manual transmission: press the clutch pedal all the way down and move the gearbox lever into neutral.
- Automatic transmission: press the brake pedal and move the selector lever to the P position or into N.
- Turn the key to the ③ position. The key automatically returns to the ② position. Do not press the accelerator.

Start-Stop system*

When you stop and release the clutch pedal, the Start-Stop system* turns off the engine. The ignition remains switched on.



» » » \triangle in Introduction on page 196



» » » page 196

Lights and visibility

Light switch

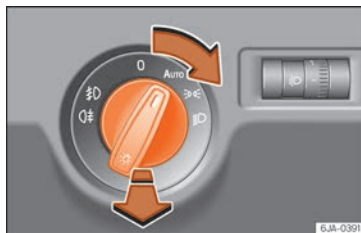

Fig. 30 Instrument console: light panel.

Turn the switch to the required position

» » Fig. 30.

Sym- bol	Ignition switched off	Ignition is switched on
0	Fog lights, dipped beam and side lights off.	Light off or daytime driving light on.
AUTO	The "Coming home" and "Leaving home" guide lights may be switched on.	Automatic control of dipped beam and daytime running light.
$\Rightarrow \Leftarrow$	Side light on.	
\equiv	Dipped beam headlight off	Dipped beam switched on.

∞ Fog lights: move the switch to the first position, from positions AUTO, $\Rightarrow \Leftarrow$ or \equiv .

\Leftarrow Rear fog light: move the switch completely from positions AUTO, $\Rightarrow \Leftarrow$ or \equiv .

Turn on fog lights: push the switch or turn it to the 0 position.



» » » \triangle in Introduction on page 120



» » » page 120

Turn signal and main beam lever

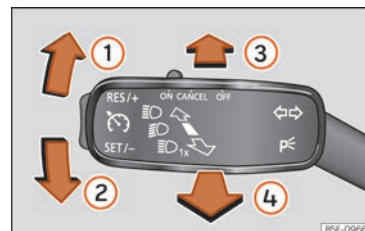



Fig. 31 Turn signal and main beam lever.

Move the lever to the required position:

① Right turn light: right-hand parking light (ignition switched off).

»

- ② Left turn light: left-hand parking light (ignition switched off).
- ③ Main beam on: control lamp  lit up on the instrument panel.
- ④ Light flash: on with the lever pushed. Control lamp  lit up.

Lever all the way down to switch it off.



»» page 122

Hazard warning lights



Fig. 32 Dashboard: switch for hazard warning lights.

Switched on, for example:

- When approaching a traffic jam
- In an emergency
- The vehicle has broken down

- When towing or being towed



»» page 125

Interior lights

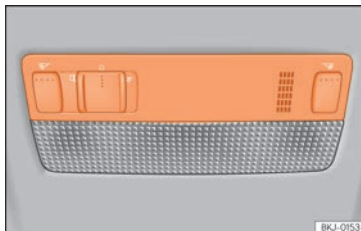

Fig. 33 Detail of headliner: variant 1

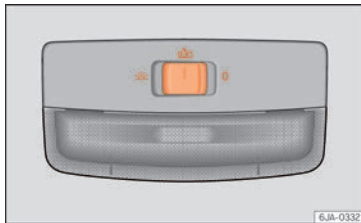





Fig. 34 Detail of headliner: variant 2

Knob	Function
0	Switches interior lights off.
	Switches interior lights on.
	Switches door contact control on (central position). The interior lights come on automatically when the vehicle is unlocked, a door is opened or the key is removed from the ignition. The lights go off a few seconds after all the doors are closed, the vehicle is locked or the ignition is switched on.
	Turning the reading light on and off



»» page 126

Windscreen wipers and window wiper blade

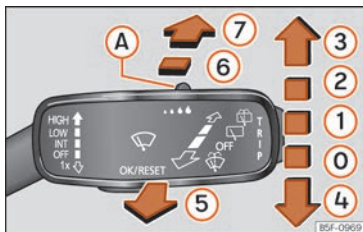

Fig. 35 Operating the windscreen wiper and rear wiper.

More the lever to the required position:

0	OFF	Windscreen wipers off.
1		Windscreen wipers interval wipe. Using the control » Fig. 35 (A) adjust the interval [vehicles without rain sensor], or the sensitivity of the rain sensor.
2	LOW	Slow wipe.
3	HIGH	Continuous wipe.
4	1x	Short wipe. Brief press, short clean. Hold the lever down for more time to increase the wipe frequency.

More the lever to the required position:

5		Automatic wipe. The windscreen washer function is activated by pushing the lever forwards, and simultaneously the windscreen wipers start.
6		Interval wipe for rear window. The wiper will wipe the window approximately every six seconds.
7		The rear window wash function is activated by pressing the lever, and the rear wiper starts simultaneously.



» » ⚠ in Introduction on page 128



» » page 128

SOS

» » page 56

Easy Connect

Menu settings: Vehicle



Fig. 36 Easy Connect: Main menu.

The actual number of menus available and the name of the various options in these menus will depend on the vehicle's electronics and equipment.

- Switch the ignition on.
- If the Infotainment System is off, switch it on.
- Press the Infotainment button **MENU** and then the **Vehicle** function button **»» Fig. 36**,



Fig. 37 Easy Connect: CAR menu.

or, press the Infotainment button **CAR** to go to the **Vehicle** menu **»» Fig. 37**.

- Press the **SETTINGS** function button to open the **Vehicle settings** menu.
- To select a function in the menu, press the desired button.

When the function button check box is activated , the function is active.

Pressing the menu button **↶** will always take you to the last menu used.

Any changes made using the settings menus are automatically saved on closing those menus.

The essentials

Menu	Submenu	Possible setting	Description
ESC system	-	Activation of the Electronic Stability Programme (ESC)	»» page 201
Tyres	Tyre monitor system	Tyre pressure storing (Calibration)	»» page 260
	Winter tyres	Activation and deactivation of the speed warning. Setting the speed warning value	»» page 261
Lights	Light assist	Motorway function, turning-on time, automatic lights when raining, one-touch signalling.	»» page 120
	Vehicle interior lighting	Brightness of instrument panel and controls	»» page 127
	"Coming home/Leaving home" function	Switch-on time of the "Coming home" and "Leaving home" functions	»» page 124
Driver assistance	Front Assist (emergency braking assistance system)	Activation/deactivation: Front Assist, advance warning, distance warning display	»» page 219
	Fatigue detection	Activation/deactivation	»» page 230
Parking and manoeuvring	Parking and manoeuvring settings	Automatically activate front volume, front sound treble, rear volume, rear sound treble	»» page 227
Ambient lighting	-	Background lighting, switch-off, colour	»» page 127
Mirrors and windscreen wipers	Rear view mirrors	Activate/deactivate folding after parking	»» page 130
	Windscreen wipers	Activate and deactivate automatic wipe in case of rain, wipe when reversing	»» page 23
Opening and closing	Electric windows control	Convenience open function, all, only driver	»» page 119
	Central locking	Unlocking doors, automatic lock when driving, interior monitoring	»» page 110
Instrument panel	-	Current consumption, average consumption, convenience consumers, ECO Advice, travelling time, distance travelled, average speed, digital speed display, speed warning, oil temperature, reset data "when setting off", reset data for "total calculation"	»» page 28
Date and time	-	Time source, time, time zone, time format, date, date format	»» page 100

»

The essentials

Menu	Submenu	Possible setting	Description
Units	-	Distance, speed, temperature, volume, fuel consumption, pressure	-
Service	-	Chassis number, date of next SEAT service inspection, date of next oil change service	»» page 33
Factory settings	A11	Restore all settings	-
	Individual	Restore factory settings for lights, driver assistance, parking and manoeuvring	

WARNING

Any distraction may lead to an accident, with the risk of injury. Operating the Easy Connect system while driving could distract you from traffic.

Driver information system

Introduction

With the ignition switched on, it is possible to read the different functions of the display by scrolling through the menus.

In vehicles with multifunction steering wheel, the multifunction display can only be operated with the steering wheel buttons.

The number of menus displayed on the instrument panel will vary according to the vehicle electronics and equipment.

A specialised workshop will be able to programme or modify additional functions, according to the vehicle equipment. SEAT recommends visiting a SEAT Official Service.

Some menu options can only be read when the vehicle is at a standstill.

As long as a priority 1 warning is displayed, it will not be possible to read the menus » **page 32**. Some warning messages can be confirmed and made to disappear with the windscreen wiper lever button or the multifunction steering wheel button.

The information system also provides the following information and displays (depending on the vehicle's equipment):

Driving data » **page 28**

- Since start

- Since refuelling
- Long-term

Assistance systems » **page 30**

Navigation » **page 178**

Audio » **page 171**

Telephone » **page 189**

Vehicle status » **page 31**

WARNING

Any distraction may lead to an accident, with the risk of injury.

- Do not operate the instrument panel controls when driving.

Operating the instrument panel menus



Fig. 38 Windscreen wipers lever: control buttons.



Fig. 39 Right side of the multifunction steering wheel: control buttons.

The driver information system is controlled with the multifunction steering wheel buttons » **Fig. 39** or with the windscreen wiper lever » **Fig. 38** (if the vehicle is not equipped with multifunction steering wheel).

Enabling the main menu

- Switch the ignition on.
- If a message or vehicle pictogram appears, press button » **Fig. 38** (1) on the windscreen wiper lever or button **OK** on the multifunction steering wheel » **Fig. 39**.
- If using the wiper lever: to display the main screen or to return to the main menu from another menu, hold down the rocker button » **Fig. 38** (2).
- If handled with the multi-function steering wheel: the main menu list will not be displayed. To go from point to point in the main »

menu, press button  or  several times »» Fig. 39.

Select a submenu

- Press the rocker switch »» Fig. 38 ② on the windscreen wiper lever up or down or turn the thumbwheel of the multifunction steering wheel »» Fig. 39 until the desired option appears marked on the menu.
- The selected option is displayed between two horizontal lines. In addition, a triangle is displayed on the right: ◀
- To consult the submenu option, press button »» Fig. 38 ① on the windscreen wiper lever or button  on the multifunction steering wheel »» Fig. 39.

Making changes according to the menu

- With the rocker switch on the windscreen wiper lever or the thumbwheel of the multifunction steering wheel, make the desired changes. To increase or decrease the values more quickly, turn the thumbwheel faster.
- Mark or confirm the selection with button »» Fig. 38 ① on the windscreen wiper lever or button  on the multifunction steering wheel »» Fig. 39.

Selection menu

Menu	Function
Driving data	Information and possible configurations of the multifunction display (MFD) »» page 28.
Assistance systems	Information and possible configurations of the driver assistance systems »» page 30.
Navigation	Information of the enabled navigation system: when a route guidance is activated, the turning arrows and proximity bars are displayed. The appearance is similar to the Easy Connect system. If route guidance is not activated, the direction of travel (compass) and the name of the street along which you are driving are shown »» page 178.
Audio	Station display on the radio. Track name on the CD. Track name in Media mode »» page 172.
Telephone	Information and possible pre-installation settings for mobile phone »» page 189.
Lap timer*	In a racing circuit, measurement and memorisation of lap times by the vehicle and comparison with previously measured best times »» page 30.

Menu	Function
Vehicle status	Display of the current warning or information texts and other system components, according to equipment »» page 31.

Driving data

The multifunction display (MFA) shows different values for the journey and the consumption.

Changing between display modes on the MFD

- In vehicles without multifunction steering wheel: press the rocker switch  on the windscreen wiper lever »» Fig. 38.
- In vehicles with multi-function wheel: rotate the thumbwheel »» Fig. 39.

Multifunction display memory

The multifunction display is equipped with three memories that work automatically:

- since start
- since refuelling
- total value.

On the screen display, you can read which memory is currently displayed.

Toggle between memories with the ignition on and the memory displayed

- Press the **OK/RESET** button on the windscreen wiper lever or the **OK** button of the multifunction steering wheel.

Menu	Function
Since start	Display and storage of the values for the journey and the consumption from when the ignition is switched on to when it is switched off. If the journey is continued in less than 2 hours after the ignition is switched off, the new data is added to the data already stored in the memory. The memory will automatically be deleted if the journey is interrupted for more than 2 hours.
Since refuelling	Display and storage of the values for the journey and the consumption. By refuelling, the memory will be erased automatically.
Long-term	The memory records the values for a specific number of partial trips, up to a total of 19 hours and 59 minutes or 99 hours and 59 minutes, or 1999.9 km or 9999 km, depending on the model of instrument panel. On reaching either of these limits ^{a1} , the memory is automatically erased and starts to count from 0 again.

^{a1} It varies according to the instrument panel version.

Erasing a memory manually

- Select the memory that you wish to erase.
- Hold the **OK/RESET** button of the multifunction steering wheel or the **OK** button of the multifunction wheel pressed down for about 2 seconds.

Personalising the displays

In the Easy Connect system you can adjust which of the possible displays of the multifunction display (MFD) can be shown on the instrument panel display with the **CAR** button and the **SETTINGS** function button
>>> page 24.

Data summary

Menu	Function
Current fuel consumption	The current fuel consumption display operates throughout the journey, in litres/100 km; and with the engine running and the vehicle stopped, in litres/hour.
Average fuel consumption	After turning on the ignition, average fuel consumption in litres/100 km will be displayed after travelling about 100 metres. Otherwise horizontal lines are displayed. The value shown is updated approximately every 5 seconds. ACT[®]* : Depending on the equipment, number of active cylinders.

Menu	Function
Operating range	Approximate distance in km that can still be travelled with the fuel remaining in the tank, assuming the same style of driving is maintained. This is calculated using the current fuel consumption.
Travelling time	This indicates the hours (h) and minutes (min) since the ignition was switched on.
Journey	Distance covered in km (m) after switching on the ignition.
Average speed	The average speed will be shown after a distance of about 100 metres has been travelled. Otherwise horizontal lines are displayed. The value shown is updated approximately every 5 seconds.
Digital display of speed	Current speed displayed in digital format.
Speed warning at --- km/h or Speed warning at --- mph	If the stored speed is exceeded (between 30 - 250 km/h, or 19 - 155 mph), an audible warning is given together with a visual warning.
Oil temperature	Updated engine oil temperature digital display
Coolant temperature gauge	Digital display of the current temperature of the liquid coolant. >>

Menu	Function
Convenience consumers	Information about the vehicle's main convenience consumers. It is displayed by means of a consumption indicator bar.
Eco tips	Tips on how to save fuel.
Reset data "when setting off"	Reset journey data when setting off.
Reset data for "total calculation"	Reset travel journey to zero.

Storing a speed with the speed warning

- Select the display **Speed warning at --- km/h (--- mph)**
- Press the button **OK/RESET** on the windscreen wiper lever or the button **OK** on the multifunction steering wheel to store the current speed and activate the warning.
- Activate: adjust to the desired speed within 5 seconds using the rocker switch **TRIP** on the windscreen wiper lever or by turning the thumbwheel on the multifunction steering wheel. Next, press the button **OK/RESET** or **OK** again or wait several seconds. The speed is stored and the warning activated.
- Deactivate: press the button **OK/RESET** or **OK**. The stored speed is deleted.

Assistance systems menu

Menu	Function
Front Assist	Switching the monitoring system on and off » page 219.
Fatigue detection*	Switching the fatigue detection on or off [pause recommendation] » page 230.

Timer*

You can access the timer via the selection menu » page 28.

It allows you to manually time lap times on a racing circuit, memorise them and compare them to the vehicle's previous best times.

The following menus can be displayed:

- **Stop**
- **Lap**
- **Pause**
- **Partial time**
- **Statistics**

Change from one menu to another

- *Vehicles without multifunction steering wheel:* press the rocker switch **TRIP** on the windscreen wiper lever.

- *Vehicles with multi-function wheel:* press the key **Δ** or **▽**.

Menu "Stop"	
Start	The timer starts. If there are existing laps and they are included in the statistics, it will begin with the number of laps in question. It is only possible to begin with a new first lap if the statistics have been reset first in the Statistics menu.
Since start	The timer begins when the vehicle sets off. If the vehicle is already moving, the timer begins once the vehicle has stopped.
Statistics	The Statistics menu is displayed on the screen.
Menu "Lap"	
New lap	The timer of the current lap stops and a new lap starts immediately. The time for the lap you have just completed is included in the statistics.
Partial time	For approx. 5 seconds a partial time is displayed. The timer continues in parallel.
Stop	The current lap timer will be interrupted. The lap does not end. The Pause menu is displayed.

Menu "Pause"

Continue	The interrupted timer continues.
New lap	A new timer starts. The halted lap ends and is included in the statistics.
Interr. Lap	The timer of the current lap ends and is cancelled. It is not included in the statistics.
End	The current timer ends. The lap is included in the statistics.

Menu "Partial time"

Partial time	For approx. 5 seconds a partial time is displayed. The timer continues in parallel.
New lap	The timer of the current lap stops and a new lap starts immediately. The time for the lap you have just completed is included in the statistics.
Stop	The current lap timer will be interrupted. The lap does not end. The Pause menu is displayed.

Menu "Statistics"

	View of the latest lap times: – total time – best lap time – worst lap time – average lap duration A maximum of 10 laps is possible, and a total duration of 99 hours, 59 minutes and 59 seconds. If one of the 2 limits is reached, you will have to reset the statistics in order to begin a new timer.
Back	This returns to the previous menu.
Resetting to zero	All the memorised statistical data are reset.

⚠ WARNING

Do your best to avoid handling the timer while driving.

- Only set the timer or consult statistics when the vehicle is stationary.
- While driving, do not handle the timer in complicated driving situations.

Status display





Bonnet, rear lid and doors open

Fig. 4.0 A: bonnet open; B: rear lid open; C: left front door open; D: right back door open (only in 5-door vehicles).

When the ignition is switched on or when driving, the bonnet, rear lid or doors that are »

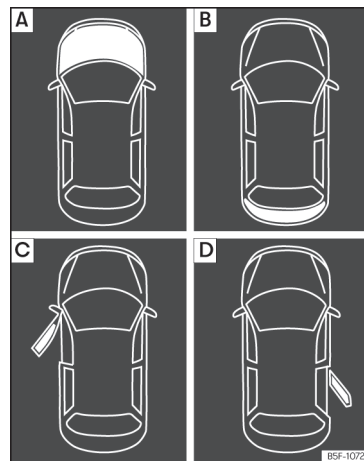
open will be indicated on the instrument panel display, and, as applicable, this will be indicated audibly. The display may vary according to the type of instrument panel fitted.

Illustration	Key to »» Fig. 40
A	 Do not continue driving! The bonnet is open or is not properly closed »» page 244.
B	 Do not continue driving! The rear lid is open or is not properly closed »» page 12.
C, D	 Do not continue driving! A vehicle door is open or is not properly closed »» page 110.





»» page 99

Warning and information messages

The system runs a check on certain components and functions when the ignition is switched on and while the vehicle is moving. Faults in the operation are displayed on the screen using red and yellow symbols and messages on the instrument panel display (»» page 34, »» page 34) and, in some cases, with audible warnings. The display may vary according to the type of instrument panel fitted.

Priority 1 warning (red symbols)

Symbol flashing or lit; partly combined with audible warnings.

 **Stop the vehicle!** It is dangerous »»  in Control and warning lamps on page 103!

Check the function that is faulty and repair it. If necessary, request assistance from specialised personnel.

Priority 2 warning (yellow symbols)

Symbol flashing or lit; partly combined with audible warnings.

A faulty function, or fluids which are below the correct levels may cause damage to the vehicle! »»  in Control and warning lamps on page 103

Check the faulty function as soon as possible. If necessary, request assistance from specialised personnel.

Informative text

Information relating to different vehicle processes.

Saving tips

Tips on how to save fuel will be displayed in conditions that increase fuel consumption. Follow them to reduce consumption. The indications appear automatically only with the efficiency programme. After a time, the tips will disappear automatically.



If you wish to hide a saving tip immediately after it appears, press any button on the

windscreen wiper lever*/multifunction steering wheel*.

Note

- If you hide a saving tip, it will reappear after you switch the ignition on again.
- The saving tips do not appear in all situations, but rather with a large separation of time.

Speed warning device

The speed warning device warns the driver when they have exceeded the pre-set speed limit by 3 km/h (2 mph). An audible warning signal sounds, and the warning lamp  and the driver message **Speed Limit exceeded!** will be displayed simultaneously on the instrument panel. The warning lamp  switches off after reducing speed below the stored maximum limit.

Speed warning programming is recommended if you wish to be reminded of a maximum speed, such as when travelling in a country with different speed limits or for a maximum speed for winter tyres.

The warning limit can be set from 30 to 250 km/h (19 to 155 mph) »» page 30. The adjustment is made at 5 km/h (3 mph) intervals.

Note

- Please bear in mind that, even with the speed warning function, it is still important to keep an eye on the vehicle speed with the speedometer and to observe the legal speed limits.
- The speed limit warning function in the version for some countries warns you at a speed of 120 km/h (75 mph). This is a factory-set speed limit.

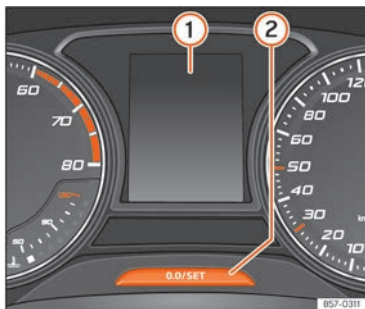
Service intervals**Fig. 41** Instrument panel

The service interval indication appears on the instrument panel display »» **Fig. 41 1**.

SEAT distinguishes between services with engine oil change (e.g. Oil change service) and services without engine oil change (e.g. Inspection).

In vehicles with **Services established by time or mileage**, the service intervals are already pre-defined.

In vehicles with **LongLife Service**, the intervals are determined individually. Thanks to technological progress, maintenance work has been greatly reduced. Because of the technology used by SEAT, with this service you only need to change the oil when the vehicle so requires. To calculate this variation (max. 2 years), the vehicle's conditions of use and individual driving styles are considered. The advance warning first appears 20 days before the date established for the corresponding service. The kilometres (miles) remaining until the next service are always rounded up to the nearest 100 km (miles) and the time is given in complete days. The current service message cannot be viewed until 500 km after the last service. Prior to this, only lines are visible on the display.

Inspection reminder

When the Service date is approaching, when the ignition is switched on a **Service reminder** is displayed.

Vehicles without text messages, a spanner symbol  is displayed on the instrument panel and a figure given in **km**.

The kilometres indicated are the maximum number of kilometres that can be travelled until the next service. After a few seconds, the display mode changes. A clock symbol appears and the number of days until the next service is due.

Vehicles with text messages, **Service in --- km (miles) or --- days** is displayed on the instrument panel.

Service due

When **the service date is due**, an audible warning is given when the ignition is switched on and the spanner displayed on the screen flashes for a few seconds .

Vehicles with text messages, **Service in --- km or --- days** is displayed on the instrument panel.

Check a service warning

With the ignition switched on, the engine off and the vehicle at a standstill, the current **service notification** can be read:

Press and hold the button **0.0/SET** for more than 5 seconds to consult the service message »» **Fig. 41 2**.

»

When the **service date has passed**, a minus sign is displayed in front of the number of kilometres or days.

Vehicles with text messages: **Service since --- km or --- days ago** will be shown on the display.

Resetting service interval display

If the service was not carried out by a SEAT dealership, the display can be reset as follows:

- Switch off the ignition, press and hold the button **[0.0/SET]** »» Fig. 41 ②.
- Switch ignition back on.
- Release the button **[0.0/SET]** and press it again for the next 20 seconds.

i Note

- The service message disappears after a few seconds, when the engine is started or when **[OK/RESET]** is pressed on the windscreen wiper lever, or **[OK]** on the multifunction steering wheel.
- In vehicles with the LongLife system in which the battery has been disconnected for a long period of time, it is not possible to calculate the date of the next service. Therefore the service interval display may not be correct. In this case, bear in mind the maximum service intervals permitted »»  page 262.

Cruise control

Operating the cruise control system (CCS)*

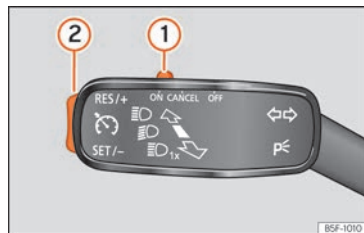

Fig. 42 Left of the steering column: CCS switch and controls.

- Switching on the CCS: Move switch »» Fig. 42 ① to **ON**. The system is on. If no speed has been programmed, the system will not control it.
- Activate the CCS: Press button »» Fig. 42 ② in the **SET/-** area. The current speed is memorised and controlled.
- Temporarily switching off the CCS: Move switch »» Fig. 42 ① to **CANCEL** or push the brake. The cruise control system is switched off temporarily.
- Reactivating the CCS: Press button »» Fig. 42 ② in **RES/+**. The memorised speed is saved and controlled again.

- Increasing stored speed during CCS regulation: press button ② in **RES/+**. The vehicle accelerates until the new stored speed.
- Reducing stored speed during CCS regulation: press button ② in **SET/-** to lower the speed by 1 km/h (1 mph). Speed is reduced until reaching the new stored speed.
- Switching off the CCS: Move switch »» Fig. 42 ① to **OFF**. The system is disconnected and the memorised speed is deleted.



»» ⚠ in Cruise control operation on page 218







»» page 217















Warning lamps





Control and warning lamps

Red warning lamps











	Notification central lamp: additional information on the instrument panel display
	Parking brake on »» page 200.
	Fault in the brake system »» page 200.
	Fault in the steering system »» page 209.
	Driver or passenger has not fastened seat belt »» page 63.





Yellow warning lamps



	Notification central lamp: additional information on the instrument panel display
	Front brake pads worn »»» page 200.
	Fault in ESC or disconnection caused by the system; OR ESC or ASR in operation »»» page 201.
	ASR manually deactivated »»» page 201.
	Fault in the ABS »»» page 201.
	Rear fog light switched on »»» page 120.
	Fault in the emission control system »»» page 213.
	Pre-heating of the diesel engine; OR fault in the management of the diesel engine »»» page 213.
EPC	Fault in the petrol engine management »»» page 213.
	Particulate filter blocked »»» page 213.
	Fault in the steering system »»» page 209.
	Tyre monitor system »»» page 260.
	Fuel tank almost empty »»» page 102.
	Fault in airbag system and seat belt tensioners »»» page 73.
OFF 	Front passenger front airbag is disabled »»» page 73.

	Fault in the lighting of the vehicle »»» page 120.
	Windshield cleaning fluid too low »»» page 128.
	Low engine oil level »»» page 247.
	Fault in the gearbox »»» page 207.

Other warning lamps

	Turn lights or emergency lights on »»» page 120.
	Trailer turn signals »»» page 120.
	Press the foot brake »»» page 204.
	Cruise control »»» page 217.
	Main beam on or flasher on »»» page 120.
	Door(s), rear lid or bonnet open or not properly closed »»» page 31.
	Engine cooling fluid »»» page 248.
	Engine oil pressure »»» page 247.
	Fault in the battery »»» page 253.
SAFE	Electronic immobiliser active »»» page 197.
	Service interval display »»» page 33.
	Mobile telephone is connected via Bluetooth® »»» page 189.

	Mobile telephone battery charge status »»» page 189.
	Risk of freezing »»» page 100.
	Start-Stop system activated »»» page 215.
	Start-Stop system unavailable »»» page 215.
	Low consumption driving status »»» page 100.

	»»  in Control and warning lamps on page 103
	»»» page 103

Gearbox lever

Manual gearbox

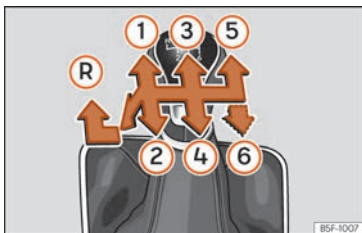

Fig. 43 Gear shift pattern of a 5 or 6-speed manual gearbox.

The position of the gears is indicated on the gearbox lever »» **Fig. 43**.

- Press the clutch pedal and keep your foot right down.
- Move the gearbox lever to the required position.
- Release the clutch.

Selecting reverse gear

- Press the clutch pedal and keep your foot right down.
- With the gearbox lever in neutral, push it downwards, move it to the left as far as it will

go and then forwards to select reverse

»» **Fig. 43** **R**.

- Release the clutch.



»» ⚠ in Changing gears on page 203



»» page 203

Automatic gearbox*

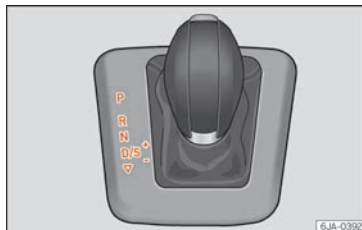

Fig. 44 Automatic transmission: selector lever positions.

- P** Parking lock
- R** Reverse gear
- N** Neutral (idling)
- D** Drive (forward)
- S** Sports program: drive (forward)

+/- Tiptronic mode: pull the lever forwards (+) to go up a gear or backwards (-) to go down a gear.



»» ⚠ in Basic information on page 204



»» page 203

SOS

»» page 36

Manual release of the selector lever



Fig. 45 Manual release of the selector lever.

If there is a fault in the power system to the electronic selector lever lock system (flat battery, blown fuse) or the system itself is faulty, the selector lever cannot be moved from position **P** in the normal manner, which prevents the vehicle from being moved. The

selector lever must be unlocked using the manual release.

- Apply the handbrake.
- Pull gently on both sides at the front of the selector lever cover.

- Also loosen the cover at the rear.
- Press the yellow plastic part with your finger in the direction indicated by the arrow
»» Fig. 45.

- Press the interlock button on the selector lever knob at the same time and move the selector lever to position **N** (if the selector lever is moved back to position **P**, it will lock again).

Air conditioning

How does Climatronic* work?

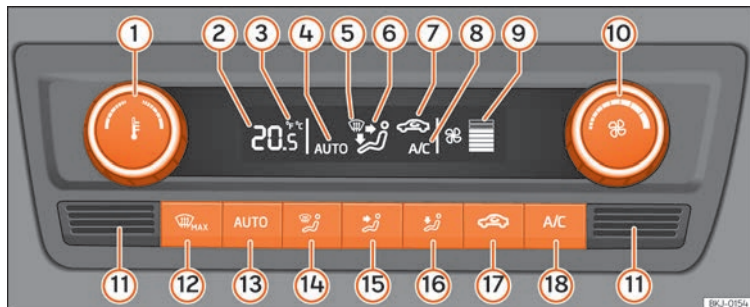

Fig. 46 In the centre console: Climatronic control panel.

Buttons/controls

① Interior temperature setting

Display

② Selected interior temperature

③ Degrees Centigrade or Fahrenheit

④ Automatic air conditioning mode

⑤ Defrost or demist windscreen

⑥ Air flow direction

⑦ Air recirculation

⑧ Cooling on/off

⑨ Selected blower speed

Buttons/controls

⑩ Set blower speed

⑪ Interior temperature sensor

⑫ Defrost or demist windscreen

- 13 Automatic mode
- 14 Air distribution to windows
- 15 Air distribution to upper body
- 16 Air distribution to footwells
- 17 Air recirculation
- 18 Cooling on/off



» » ⚠ in General notes on page 146



» » page 151

How does the manual air conditioning* work?

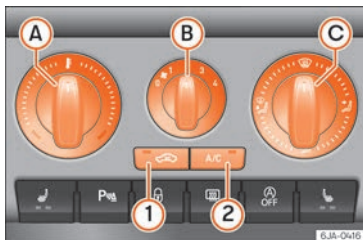

Fig. 47 In the centre console: manual air conditioning control panel.

- A Temperature
 - B Blower
 - C Air distribution
 - ☒ – Air distribution towards the wind-screen in order to demist or defrost.
 - ☒ – Air distribution to upper body.
 - ☒ – Air distribution to footwell.
 - ☒ – Air distribution to the windscreen and the footwell.
- ① Air recirculation
- ② A/C: Switching the cooling system on

Basic positions	Control position			Button		Air vents 4
	A	B	C	①	②	
Windscreen and side window defrost or demist	Full right	3 or 4		Switched off	Switched on automatically ^{a)}	Open and direct towards the side window
Mild heating	Required temperature	2 or 3		Do not switch on	Do not switch on	Opening
Cool as quickly as possible	Anti-clockwise as far as it will go	Briefly 4, then 2 or 3		It is switched on automatically ^{b)}	Switched on	Opening

Basic positions	Control position			Button		Air vents 4
	Ⓐ	Ⓑ	Ⓒ	①	②	
Optimum cooling	Required temperature	1 or 2		Do not switch on	Switched on	Open and direct towards the roof
Fresh air mode - blower	Anti-clockwise as far as it will go	Required position		Do not switch on	Switched off	Opening

a) The lamp in button ② lights up, even if not all of the conditions for cooling system operations are met. Cooling is indicated as available once all of the conditions are met
 »» page 149, Manual operation.

b) In certain conditions, air recirculation mode can switch on automatically »» page 150, a lamp illuminates in the button.



»» in General notes on page 146



»» page 149

How does the heating and the fresh air system work?

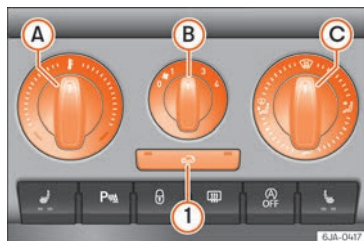

Fig. 48 Centre console: heating system and fresh air controls.

Ⓐ Temperature

Ⓑ Blower

Ⓒ Air distribution

– Air distribution towards the windscreen in order to demist or defrost.

– Air distribution to upper body.





– Air distribution to footwell.

– Air distribution to the windscreen and the footwell.

① Air recirculation



The essentials

Basic positions	Control position			Button ①	Air vents ④
	Ⓐ	Ⓑ	Ⓒ		
Windscreen and side window defrost or demist	Full right	3 or 4		Switched off	Open and direct towards the side window
Mild heating	Required temperature	2 or 3	 / 	Do not switch on	Opening
Fresh air mode - blower	Anti-clockwise as far as it will go	Required position		Do not switch on	Opening



»» ⚠ in General notes on page 146



»» page 148

Fluid level control

Filling capacities

Capacities	
Fuel tank	55 litres, of which 7 litres act as reserve.
Windscreen washer fluid container in version without headlight washer	3.5 litres
Windscreen washer fluid container in versions with headlight washer	5.4 litres

Fuel

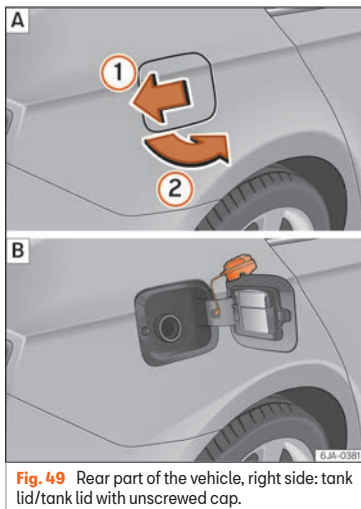

Fig. 49 Rear part of the vehicle, right side: tank lid/tank lid with unscrewed cap.

The flap that covers the tank cap is unlocked and locked automatically using the central locking.

Opening the fuel tank cap

- Press the fuel tank flap in the direction of the arrow ① »» Fig. 49 A and open it in the direction of the arrow ②.

- Unscrew the cap by turning it to the left.
- Rest it on the upper part of the fuel tank flap »» Fig. 49 B.

Closing the fuel tank cap

- Unscrew the cap by turning it to the right as far as it will go.
- Close the lid.



»» ⚠ in Refuelling on page 242



»» page 241

Oil

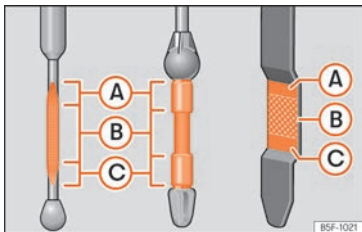

Fig. 50 Engine oil dipstick.



Fig. 51 In the engine compartment: Engine oil filler cap.

The level is measured using the dipstick located in the engine compartment
 »» page 246.

The oil indicator must be between zones **(A)** and **(C)**. It can never go above zone **(A)**.

- Zone **(A)**: do not add oil.
- Zone **(B)**: you can add oil but keep the level in that zone.
- Zone **(C)**: add oil until zone **(B)**.

Topping up engine oil

- Unscrew cap from engine oil filler opening
 »» Fig. 51.
- Add oil slowly.
- At the same time, check the level to ensure you do not add too much.
- When the oil level reaches at least zone **(B)**, unscrew the engine oil filler cap carefully.

Engine oil additives

No type of additive should be mixed with the engine oil. The deterioration caused by these additives is not covered by the warranty.

Engine oil specifications

Diesel engines

Engine type	Type of Service	Specification
With particulate filter [DPF] ^{a)}	Set Service and Flexible Service Intervals	VW 507 00

^{a)} Only use recommended oils, otherwise you may damage the engine.

If the engine oil level is too low

You can get information about the correct engine oil for your vehicle in your specialised shop. If you have to change your engine oil, use this oil.

If the recommended engine oil is not available, in the event of an **emergency** you can change the oil **once** with a maximum of 0.5 L of the next oil until the next oil change:

- *Petrol engines:* standard VW 504 00, VW 502 00, VW 508 00, ACEA C3 or API SN.
- *Diesel engines:* standard VW 507 00, VW 505 01, ACEA C3 or API CK-4.

Have the oil changed by a specialised workshop.

Using engine oil that is compliant with the VW 504 00 standard instead of VW 508 00 could increase consumption and the vehicle's CO₂ emissions.

EDGE PROFESSIONAL

Recommended by SEAT

SEAT recommends using original SEAT oil to guarantee high SEAT engine performance.



»» page 247

Coolant



Fig. 52 Engine compartment: coolant expansion tank cap.

The coolant tank is located in the engine compartment »»»  page 246.

When the engine is cold, replace the coolant when the level is below **MIN**.

Coolant specifications

The engine cooling system is supplied from the factory with a specially treated mixture of water and at least 40 % of the additive **G13** (TL-VW 774 J), purple. This mixture gives the necessary frost protection down to -25°C (-13°F) and protects the light alloy parts of the engine cooling system against corrosion. It also prevents scaling and considerably raises the boiling point of the coolant.

To protect the cooling system, the percentage of additive must always be at least 40 %,

even in warm climates where anti-freeze protection is not required.

If for weather reasons further protection is necessary, the proportion of additive may be increased, but only up to 60 %; otherwise antifreeze protection will diminish and this will worsen cooling.

When the coolant is topped up, use a mixture of **distilled water** and at least 40 % of the G13 or G12 plus-plus (TL-VW 774 G) additive (both are purple) to obtain optimal anti-corrosion protection. The mixture of G13 with G12 plus (TL-VW 774 F), G12 (red) or G11 (green-blue) engine coolants will significantly reduce anti-corrosion protection and should therefore be avoided.



»»»  in Topping up the coolant level on page 250



»»» page 248

Brake fluid



Fig. 53 Engine compartment: brake fluid reservoir cap.

The brake fluid reservoir is located in the engine compartment »»»  page 246.

The level should be between the **MIN** and **MAX** marks. If it is below **MIN**, please visit a Technical Service.



»»»  in Checking brake fluid level on page 250



»»» page 250

Windscreen washer



Fig. 54 In the engine compartment: cap of the windscreen washer tank.

The windscreen washer reservoir is located in the engine compartment »» »  **page 246**.

To top up, mix water with a product recommended by SEAT.

In cold temperatures, add anti-freeze.



»» » **page 251**



»» »  in Introduction on page 252



»» » **page 251**

Battery

The battery is located in the engine compartment »» »  **page 246**. It does not require maintenance. It is checked as part of the Inspection Service.

Emergencies

Fuses

Fuse location



Fig. 55 On the dashboard on the driver side: lid of the fuse box.

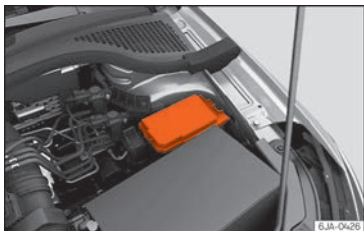

Fig. 56 In the engine compartment: lid of the fuse box.

Underneath the instrument panel

- Carefully tilt the cover in the direction indicated by the arrow and remove it »» Fig. 55.
- After changing the fuse, replace the cover on the dash panel in the direction opposite that is indicated by the arrow so that the cover tabs fit into the slots on the dash panel. Subsequently, press down on the cover to close.

In the engine compartment

Press the locking tabs to release the fuse box cover »» Fig. 56.

Identifying fuses situated below the dash panel by colours

Colour	Amp rating
Black	1
Purple	3
Light brown	5
Brown	7.5
Red	10
Blue	15
Yellow	20
White or transparent	25
Green	30
Orange	40



»» ⚠ in Introduction on page 83



»» page 83

Replacing a blown fuse

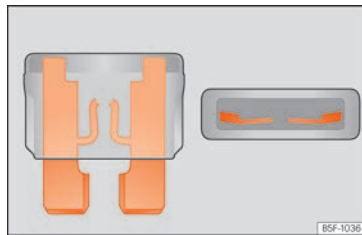

Fig. 57 Image of a blown fuse.

Preparation

- Switch off the ignition, lights and all electrical equipment.
- Open the corresponding fuse box »» 📖 page 84.

Identifying a blown fuse

A fuse is blown if its metal strip is ruptured »» Fig. 57.

Point a lamp at the fuse to see if it has blown. »

To replace a fuse

- Remove the fuse.
- Replace the blown fuse by one with an *identical* amperage rating (same colour and markings) and *identical* size.
- Replace the cover again or close the fuse box lid.

Bulbs**Bulbs (12 V)**

Full-LED headlights are designed to last the lifetime of the car and cannot be replaced. If the headlight becomes damaged, go to a specialised workshop.

Below, the light source used for all functions is broken down.

Halogen headlights.	Type
Daytime running light/side light	P21W SLL
Dipped beam headlights	H7 LL
Main beam headlights	H7 LL
Turn signal	PY21W

Full-LED main head-lights	Type
---------------------------	------

No bulbs may be replaced. All functions are with LEDs

Front fog light	Type
-----------------	------

Fog/cornering lights*

H8

Rear bulb light	Type
-----------------	------

Brake light/tail light

P21/5W

Side lights

P21/5W (side panel)
R5W (rear lid)

Turn signal

PY21W

Retro fog light

P21W

Reverse lights

P21W

LED rear lights	Type
-----------------	------

Turn signal

PY21W

Retro fog light

P21W

Reverse lights



P21W

The remaining functions work with LEDs



»» page 86

Action in the event of a puncture**What to do first**

- Park the vehicle on a horizontal surface and in a safe place as far away from traffic as possible.
- Apply the handbrake.
- Switch on the hazard warning lights.
- *Manual transmission:* select the 1st gear.
- *Automatic transmission:* Move the selector lever to position **P**.
- If you are towing a trailer, unhitch it from your vehicle.
- Have the vehicle tool kit* »»  **page 78** and the spare wheel »»  **page 259** ready.
- Observe the applicable legislation for each country (reflective vest, warning triangles, etc.).
- All occupants should leave the vehicle and wait in a safe place (for instance behind the roadside crash barrier).

⚠ WARNING

- Always observe the above steps and protect yourself and other road users.
- If you change the wheel on a slope, block the wheel on the opposite side of the car

with a stone or similar to prevent the vehicle from moving.

Repairing a tyre with the anti-puncture kit

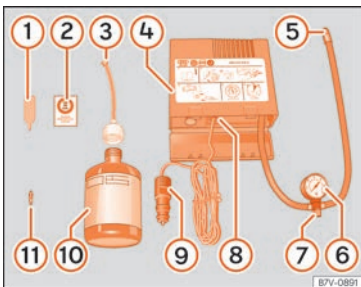

Fig. 58 Standard display: contents of the anti-puncture kit.

The anti-puncture kit is located under the floor panel in the luggage compartment.

Sealing the tyre

- Unscrew the tyre valve cap and insert. Use the »» Fig. 58 ① tool to remove the insert. Place it on a clean surface.
- Shake the tyre sealant bottle vigorously »» Fig. 58 ⑩.

- Screw the inflator tube »» Fig. 58 ③ into the sealant bottle. The bottle's seal will break automatically.
- Remove the lid from the filling tube »» Fig. 58 ③ and screw the open end of the tube into the tyre valve.
- With the tyre sealant bottle upside down, fill the tyre with the contents of the sealant bottle.
- Remove the bottle from the valve.
- Place the insert back into the tyre valve using the tool »» Fig. 58 ①.

Inflating the tyre

- Screw the compressor tyre inflator tube »» Fig. 58 ⑤ into the tyre valve.
- Check that the air bleed screw is closed »» Fig. 58 ⑦.
- Start the engine and leave it running.
- Insert the connector »» Fig. 58 ⑨ into the vehicle's 12-volt socket »»  page 138.
- Turn the air compressor on with the ON/OFF switch »» Fig. 58 ⑧.
- Keep the air compressor running until it reaches 2.0 to 2.5 bar (29-36 psi/200-250 kPa). **A maximum of 8 minutes.**
- Disconnect the air compressor.
- If it does not reach the pressure indicated, unscrew the tyre inflator tube from the valve.

- Move the vehicle 10m so that the sealant is distributed throughout the tyre.
- Screw the compressor tyre inflator into the valve.
- Repeat the inflation process.
- If the indicated pressure still cannot be reached, the tyre is too badly damaged. Stop and request assistance from an authorised technician.
- Disconnect the air compressor. Unscrew the tyre inflator tube from the tyre valve.
- When the tyre pressure is between 2.5 and 2.0 bars, continue driving without exceeding 80 km/h (50 mph).
- Attach the sticker »» Fig. 58 ② to the instrument cluster, within the driver's visual field.
- Check the pressure again after 10 minutes »»  page 81.



»»  in TMS Anti-puncture kit (Tyre Mobility System)* on page 80



»» page 79

Changing a wheel

Vehicle tool kit*

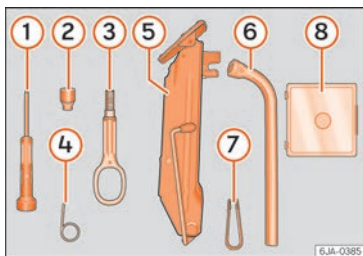

Fig. 59 Vehicle tool kit.

The vehicle tool kit and the jack are stored in a box on the spare wheel or in the spare wheel well. There is also enough space for the towing bracket ball coupling. The box is strapped to the spare wheel with tape.

The vehicle tool kit includes the following parts (depending on equipment):

- ① Screwdriver
- ② Adapter for anti-theft wheel bolts
- ③ Towline anchorage
- ④ Wire hook for removing hub caps
- ⑤ Jack
- ⑥ Box spanner for wheel bolts

- ⑦ Clip for wheel bolt cover
- ⑧ Spare set of bulbs

Before stowing the jack again, screw down the arm as far as it will go.



»» ⚠ in What to do first on page 46



»» page 78

Wheel cover



Fig. 60 Remove the wheel cover.

Removing

- Place the hook from the vehicle tool kit* on the reinforced edge of the wheel trim.
- Insert the box spanner through the hook, supporting it on the tyre and remove the wheel trim.

Fitting

- Press the wheel trim onto the wheel at the cut out designed for the valve.
- Press the wheel trim on both sides in the direction of the valve so that it fits correctly in place around all the perimeter.

ⓘ CAUTION

- Press down by hand, do not hit the wheel trim! Knocking it sharply, particularly at points where the wheel trim has not yet been inserted, could result in damage to the wheel trim guiding and centring elements.
- Before fitting the trim on a steel wheel attached with an anti-theft wheel bolt, make sure the bolt is in the hole in the valve area »» page 49, Anti-theft wheel bolts*.
- Where trim is fitted at a later date, ensure enough air inflow is guaranteed in order to cool the brake system.

Wheel bolt caps

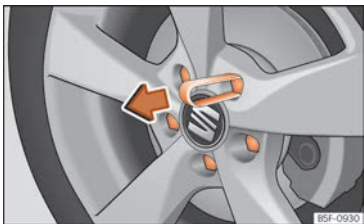

Fig. 61 Pull off the wheel bolt cap.

Removing

- Fit the plastic clip (vehicle tools) over the cap until it clicks into place »» **Fig. 61**.
- Remove the cap with the plastic clip.

Fitting

- Insert the caps as far as they will go over the wheel bolts.

The wheel bolt caps are stored in a box on the spare wheel or in the spare wheel well.

Anti-theft wheel bolts*

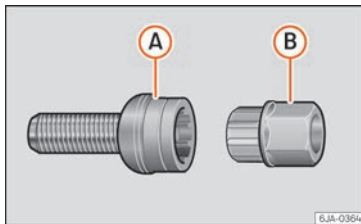

Fig. 62 Anti-theft wheel bolt with adapter.

Anti-theft wheel bolts (one bolt per wheel) can only be loosened or tightened using a factory-supplied adapter.

- Pull off the hub cap or bolt cover.
- Insert the adapter **(B)** »» **Fig. 62** with its toothed side as far as it will go on the interior tothing of the anti-theft wheel bolt **(A)** so that only the outer hexagonal is protruding.
- Fit the box spanner as far as it will go over adapter **(B)**.
- Loosen or firmly tighten the wheel bolt »» **page 49**.
- After removing the adapter, replace the hub cap or the anti-theft wheel bolt cover.

- **Check the tightening torque** as soon as possible with a torque wrench.

Note down the code number stamped on the front of the adapter or of the anti-theft wheel bolt. You will need this number to obtain a spare adapter from the SEAT original accessories programme.

You should always have a wheel bolt adapter as part of your vehicle tools.

Loosening and tightening wheel bolts



Fig. 63 Tyre change: slacken the wheel bolts. »»

Loosening wheel bolts

- Insert the box spanner onto the wheel bolt as far as it will go¹⁾.
- Grip the end of the box spanner and turn the wheel bolt about **one** turn anti-clockwise »» Fig. 63.

Tightening wheel bolts

- Insert the box spanner onto the wheel bolt as far as it will go¹⁾.
- Grip the box spanner as close to the end as possible and tighten the bolt firmly by turning clockwise.

⚠ WARNING

The wheel bolts should only be loosened slightly (about one turn) before raising the vehicle with the jack. Risk of accident!

Raising the vehicle

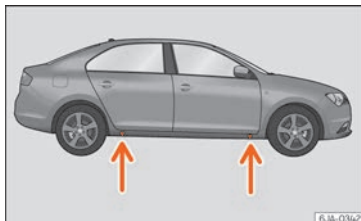

Fig. 64 Wheel change: support points of the jack.

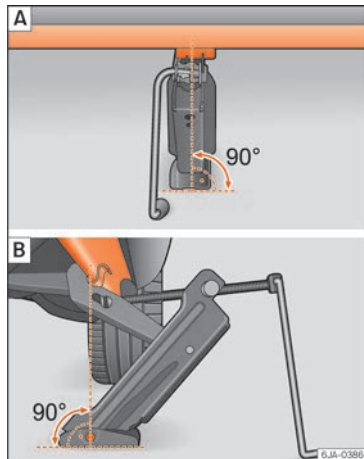

Fig. 65 Fitting the jack.

- Place the jack* (vehicle tools) on firm ground. If necessary use a large, strong board or similar support. If the surface is slippery (for example tiles) place the jack on a rubber mat or similar to prevent it from slipping »» ⚠.

¹⁾ The corresponding adapter is required to unscrew or tighten the anti-theft wheel bolts »» page 49.

- Find the support point on the strut (sunken area) closest to the wheel to be changed »» Fig. 64.
- Turn the jack*, located below the strut support point, to raise it until the tab is below the housing provided »» Fig. 65 [A].
- Align the jack* so that the tab “grips” onto the housing provided on the strut and the mobile base is resting on the ground »» Fig. 65 [B]. The base plate 2 should fall vertically with respect to the support point.
- Continue turning the jack* until the wheel is slightly lifted off the ground.

⚠ WARNING

- **Make sure that the jack* remains stable. If the surface is slippery or soft, the jack* could slip or sink, respectively, with the resultant risk of injury.**
- **Only raise the vehicle with the jack* supplied by the manufacturer. Other jacks, even those approved for other SEAT models could slip, with the consequent risk of injury.**
- **Only mount the jack* on the support points designed for this purpose on the strut, and always align the jack correctly. If you do not, the jack* could slip as it does not have an adequate grip on the vehicle: risk of injury!**
- **The height of the parked vehicle can change as a result of variations in temperature and loading.**

ⓘ CAUTION

The vehicle must not be raised on the crossbar. Only place the jack* on the points designed for this purpose on the strut. Otherwise, the vehicle may be damaged.

Removing and fitting a wheel

Change the wheel after loosening the wheel bolts and raising the vehicle with the jack.

Taking off the wheel

- Unscrew the wheel bolts using the box spanner and place them on a clean surface.
- Take off the wheel.

Putting on the spare wheel

When fitting tyres with a compulsory rotation direction, observe the instructions in »» page 51.

- Mount the wheel.
- Screw on the wheel bolts in position and tighten them loosely with a box spanner.
- Carefully lower the vehicle using the jack*.
- Tighten the wheel bolts in diagonal pairs using the wheel brace.

The wheel bolts should be clean and turn easily. Before fitting the spare wheel, inspect

the wheel condition and hub mounting surfaces. These surfaces must be clean before fitting the wheel.

Tyres with compulsory direction of rotation

A directional tread pattern can be identified by the arrows on the sidewall that point in the direction of rotation. Always observe the direction of rotation indicated when fitting the wheel to guarantee optimum properties of this type of tyres with regard to grip, noises, wear and aquaplaning.



If it is absolutely necessary to fit the spare tyre* against the direction of rotation, drive with care as this means the tyre does not offer optimum driving properties. This is of particular importance when the road surface is wet.

Replace the punctured tyre as soon as possible and restore the obligatory and correct direction of rotation of all tyres.

Subsequent work

- *Alloy wheels:* replace the wheel bolt caps.
 - *Plate wheels:* replace the wheel hubcap
- »» page 48.

»

- Return all tools to their proper storing location.
- If the replaced wheel does not fit in the spare wheel housing, store it safely in the luggage compartment »»»  page 141.
- Check the tyre pressure of the newly mounted tyre as soon as possible.
- In vehicles fitted with a tyre pressure indicator, adjust the pressure and store it in memory »»»  page 260.
- Have the tightening torque of the wheel bolts checked as soon as possible with a torque wrench (it should be 120 Nm). Meanwhile, drive carefully.
- Have the flat tyre replaced as quickly as possible.

Snow chains

Use

Snow chains should only be used on the front wheels.

In winter road conditions, snow chains not only help to improve grip but also improve the braking capacity.

For technical reasons snow chains may only be used on tyres with the following wheel rim/tyre combinations.

Rim size	Rim offset	Tyre size
5J x 14 ^{a)}	35 mm	175/70
6J x 15 ^{b)}	38 mm	185/60
6J x 15 ^{b)}	38 mm	195/55

^{a)} Only use snow chains with fine-pitch links and lock no greater than **9 mm**.

^{b)} Only use snow chains with fine-pitch links and lock no greater than **13 mm**.

Remove the wheel trims before fitting snow chains.

CAUTION

Chains must be removed when roads are free of snow. Otherwise they will impair handling, damage the tyres and wear out very quickly.

Emergency towing of the vehicle

Towing

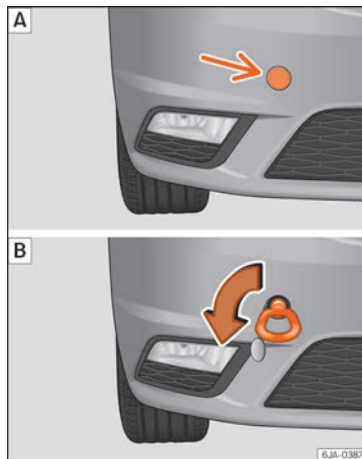

Fig. 66 Right side of the front bumper: towline anchorage screwed in.

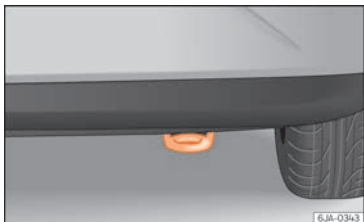



Fig. 67 Right side of the rear bumper: towline anchorage.

Towline anchorages

- Attach the bar or rope to the towline anchorages.

It is located with the vehicle's tools
»  **page 78.**

- Screw the front towline anchorage into the screw connection » **Fig. 66** and tighten it with the wheel brace.

The rear towline anchorage is under the rear bumper, on the right » **Fig. 67.**

Tow rope or tow bar

The tow bar offers increased safety and a lower risk of damage.

The tow rope is recommended when there is no tow bar. It must be elastic so that it does not damage the vehicle.

Notes for the driver of the towing vehicle

- The tow rope must be taut before you drive off.
- Release the clutch very carefully when starting the vehicle (manual gearbox), or accelerate gently (automatic gearbox).

Driving style

Towing requires some experience, especially when using a tow rope. Both drivers should realise how difficult it is to tow a vehicle. Inexperienced drivers should not attempt to tow.

Do not pull too hard with the towing vehicle and take care to avoid jerking the tow rope. When towing on an unpaved road, there is always a risk of overloading and damaging the anchorage points.

The towline anchorages are located under the floor panel in the luggage compartment.

Switch on the ignition so that the turn signals, windscreen wipers and windscreen washer can work. Ensure that the steering wheel is unlocked and moves freely.

Place the gear lever in neutral on vehicles with a manual gearbox. With an automatic gearbox, place the lever in **N**.

To brake, press the brake pedal firmly. The brake servo does not work when the engine is switched off.

The power steering only works when the ignition is switched on and the vehicle is moving, provided that the battery is sufficiently charged. Otherwise, it will need more force.

Ensure that the tow rope remains taut at all times.



» **page 81**

Tow-starting

If the engine will not start, first try starting it using the battery of another vehicle » **page 54.** You should only attempt to tow-start a vehicle if charging the battery does not work. This is done by leveraging wheel movement.

When tow-starting a vehicle with a **petrol engine**, do not tow it more than a *short* distance, otherwise unburned fuel can enter the catalytic converter.

- Engage 2nd or 3rd gear before moving off.
- Press the clutch and hold the pedal down.
- Switch the ignition on.
- Once both vehicles are moving, release the clutch.
- As soon as the engine has started, press the clutch and move the gear lever to neutral.

How to jump start

Jump leads

The jump lead must have a sufficient wire cross section.

If the engine fails to start because of a discharged battery, the battery can be connected to the battery of another vehicle to start the engine.

Both batteries need to have nominal voltage of 12 V. The **capacity** (Ah) of the back-up battery should not be notably less than the drained battery.

Jump leads must comply with standard **DIN 72553** (see cable manufacturer's instructions). The wire cross section must be at least 25 mm² for petrol engines and at least 35 mm² for diesel engines.

Jump leads

Positive cable – usually red

Negative cable – usually black

WARNING

- A flat battery can also freeze at temperatures slightly below 0°C (+32°F). Do not attempt to start the vehicle with a frozen battery. Risk of explosion!

- Please note the safety warnings referring to working in the engine compartment
»»  page 244.

- The non-insulated parts of the battery clamps must not be allowed to touch. Additionally, the jump lead attached to the positive battery terminal must not touch metal parts of the vehicle. Risk of short circuit!

- Do not connect the negative lead to the negative terminal of the discharged battery. In the event of sparks when starting the engine, the explosive gas given off by the battery could catch fire.

- Position the jump leads in such a way that they cannot come into contact with any moving parts in the engine compartment.

- Do not bend over the battery. Risk of acid burns!

- The screw plugs on the battery cells must be screwed in firmly.

- Keep sources of fire (flames, lit cigarettes, etc.) away from the battery) - Danger of explosion!

- Never use the jump leads on batteries in which the electrolyte level is too low. Risk of explosion and acid burns.

Note

- The vehicles must not touch each other, as electricity could flow as soon as the positive terminals are connected.

- The discharged battery must be properly connected to the vehicle electrical system.
- The jump leads should be checked in a specialist vehicle battery shop.

How to jump start: description

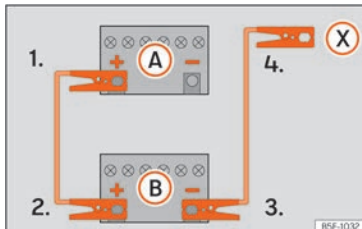

Fig. 68 Diagram of connections for vehicles without Start Stop system

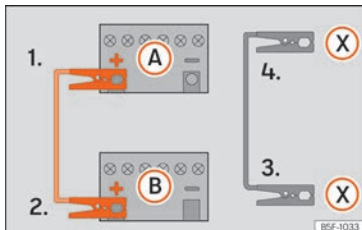



Fig. 69 Diagram of connections for vehicles with Start Stop system

Jump lead terminal connections

- Switch off the ignition of both vehicles
» 
- Connect one end of the *red* jump lead to the positive (+) terminal of the vehicle with the flat battery (A) » Fig. 68.
- Connect the other end of the *red* jump lead to the positive terminal (+) in the vehicle providing assistance (B).
- a. *In vehicles without a Start-Stop system:* connect one end of the *black* jump lead to the negative terminal (-) of the vehicle providing the current (B) » Fig. 68.
- b. *In vehicles with a Start-stop system:* connect one end of the *black* jump lead (X) to a suitable ground terminal, to a solid piece of metal in the engine block, or to the engine block itself » Fig. 69.
- Connect the other end of the *black* jump lead (X) to a solid metal component bolted to the engine block or to the engine block itself of the vehicle with the flat battery. Do not connect it to a point near the battery (A).
- Position the leads in such a way that they cannot come into contact with any moving parts in the engine compartment.

Starting

- Start the engine of the vehicle with the boosting battery and let it run at idling speed.
- Start the engine of the vehicle with the flat battery and wait for 2 or 3 minutes until the engine is running.

Removing the jump leads

- Before you remove the jump leads, switch off the dipped beam headlights if they are switched on.
- Turn on the heater blower and heated rear window in the vehicle with the flat battery. This helps minimise voltage peaks which are generated when the leads are disconnected.
- When the engine is running, disconnect the leads in reverse order to the details given above.

Make sure the battery clamps have sufficient metal-to-metal contact with the battery terminals.

If the engine fails to start after about 10 seconds, switch off the starter and try again after about 1 minute.

WARNING

- Please note the safety warnings referring to working in the engine compartment

»  page 244.

- The battery providing assistance must have the same voltage as the flat battery (12V) and approximately the same capacity (see imprint on battery). Failure to comply could result in an explosion.
- Never use jump leads when one of the batteries is frozen. Danger of explosion! Even after the battery has thawed, battery acid could leak and cause chemical burns. If a battery freezes, it should be replaced.
- Keep sparks, flames and lighted cigarettes away from batteries, danger of explosion. Failure to comply could result in an explosion.
- Observe the instructions provided by the manufacturer of the jump leads.
- Do not connect the negative cable from the other vehicle directly to the negative terminal of the flat battery. The gas emitted from the battery could be ignited by sparks. Danger of explosion.
- Never attach the negative cable to fuel system components or the brake lines in the other vehicle.
- The non-insulated parts of the battery clamps must not be allowed to touch. The jump lead attached to the positive battery terminal must not touch metal parts of the vehicle, this can cause a short circuit.
- Position the leads in such a way that they cannot come into contact with any moving parts in the engine compartment.

»

- Do not lean on the batteries. This could result in chemical burns.

Note

The vehicles must not touch each other, otherwise electricity could flow as soon as the positive terminals are connected.

Changing the windscreen wiper blades

Changing the wiper blades

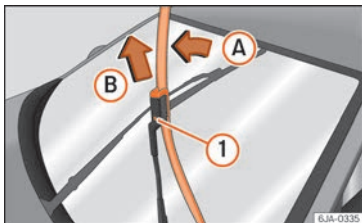

Fig. 70 Windscreen wiper blades.

Set the windscreen wiper arms to the service position before changing the blades.

Service position

- Close the bonnet.

- Switch the ignition on and off.
- Press the lever to position ④
- »» Fig. 140 »» page 129, the windscreen wiper arms are set to the service position.

Taking off the wiper blade

- Lift the windscreen wiper arm away from the glass moving the blade slightly in the direction of the arm – arrow (A) »» Fig. 70.
- Hold the top of the windscreen wiper arm with one hand.
- Unlock the catch ① with the other hand and remove the blade in the direction of arrow (B).

Fitting the wiper blade

- Slide the blade fully until it clicks into position.
- Check that the wiper is correctly secured.
- Fold the windscreen wiper arm back down onto the glass.
- Switch the ignition on and press the lever to position ④ »» Fig. 140 »» page 129, the windscreen wiper arms are set to the basic position.

Changing the rear window wiper blade*

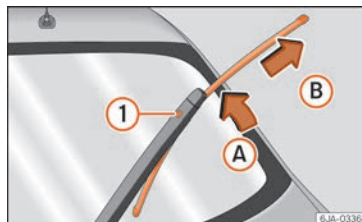

Fig. 71 Rear window wiper blade.

Taking off the wiper blade

- Lift the rear window wiper arm away from the glass moving the blade slightly in the direction of the arm – arrow (A) »» Fig. 71.
- Hold the top of the rear window wiper arm with one hand.
- Unlock the catch ① with the other hand and remove the blade in the direction of arrow (B).

Fitting the wiper blade

- Slide the blade fully until it clicks into position.
- Check that the wiper is correctly secured.
- Fold the rear window wiper arm back down onto the glass.

Safety

Safe driving

Advice about driving

Safety first!

This chapter contains important information, tips, suggestions and warnings that you should read and consider for both your own safety and for your passengers' safety.

WARNING

- This manual contains important information about the operation of the vehicle, both for the driver and the passengers. The other sections of the on-board documentation also contain further information that you should be aware of for your own safety and for the safety of your passengers.
- Ensure that the on-board documentation is kept in the vehicle at all times. This is especially important when lending or selling the vehicle to another person.

Before setting off

For your own safety and the safety of your passengers, always note the following points before every trip:

- Make sure that the vehicle's lights and turn signals are working properly.
- Check tyre pressure.
- Ensure that all windows provide a clear and good view of the surroundings.
- Make sure all luggage is secured »» page 141.
- Make sure that no objects can interfere with the pedals.
- Adjust front seat, head restraint and mirrors properly according to your size.
- Ensure that the passengers in the rear seats always have the head restraints in the in-use position »» page 62.
- Instruct passengers to adjust the head restraints according to their height.
- Protect children with appropriate child seats and properly applied seat belts »» page 75.
- Assume the correct sitting position. Instruct your passengers also to assume a proper sitting position »» page 58.
- Fasten your seat belt securely. Instruct your passengers also to fasten their seat belts properly »» page 63.

Factors influencing safety

As a driver, you are responsible for yourself and your passengers. When your concentration or driving safety is affected by any circumstance, you endanger yourself as well as others on the road »» , for this reason:

- Always pay attention to traffic and do not get distracted by passengers or telephone calls.
- Never drive when your driving ability is impaired (e.g. by medication, alcohol, drugs).
- Observe traffic laws and speed limits.
- Always reduce your speed as appropriate for road, traffic and weather conditions.
- When travelling long distances, take breaks regularly - at least every two hours.
- If possible, avoid driving when you are tired or stressed.

WARNING

When driving safety is impaired during a trip, the risk of injury and accidents increases.

Safety equipment

Never put your safety or the safety of your passengers in danger. In the event of an accident, the safety equipment may reduce the »

risk of injury. The following points cover part of the safety equipment in your SEAT:

- three-point seat belts,
- belt tensioners for the front and rear side seats,
- Belt tensioners for the front seats,
- Belt height adjustment for the front seats
- front airbags,
- side airbags in the front seat backrests,
- side airbags in the rear seat backrests*,
- head-protection airbags,
- active front head restraints*,
- "ISOFIX" anchor points for child seats in the rear side seats with the "ISOFIX" system,
- height-adjustable front head restraints,
- rear head restraints with in-use position and non-use position,
- adjustable steering column.

The safety equipment mentioned above works together to provide you and your passengers with the best possible protection in the event of an accident. However, these safety systems can only be effective if you and your passengers are sitting in a correct position and use this equipment properly.

Safety is everyone's business!

Correct position of the vehicle occupants

Correct sitting position for the driver

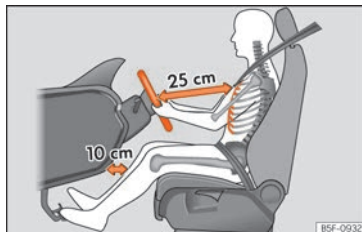

Fig. 72 The proper distance between driver and steering wheel.



Fig. 73 Correct head restraint position for the driver.

For your own safety and to reduce the risk of injury in the event of an accident, we recommend the following adjustments for the driver:

- Adjust the steering wheel so that there is a distance of at least 25 cm between the steering wheel and the centre of your chest »» **Fig. 72.**
- Move the driver's seat forwards or backwards so that you are able to press the accelerator, brake and clutch pedals to the floor with your knees still slightly angled »» **△.**
- Ensure that you can reach the highest point of the steering wheel.
- Adjust the head restraint so that its upper edge is at the same level as the top of your head, or as close as possible to the same level as the top of your head »» **Fig. 73.**
- Move the seat backrest to an upright position so that your back rests completely against it.
- Fasten your seat belt securely »» **page 63.**
- Keep both feet in the footwell so that you have the vehicle under control at all times.

Adjustment of the driver's seat

»»  **page 14.**

⚠ WARNING

- An incorrect sitting position of the driver can lead to severe injuries.
- Adjust the driver's seat so that there is at least 25 cm distance between the centre of the chest and the centre of the steering wheel » Fig. 72. If you are sitting closer than 25 cm, the airbag system cannot protect you properly.
- If your physical constitution prevents you from maintaining the minimum distance of 25 cm, contact a specialised workshop. The workshop will help you decide if special specific modifications are necessary.
- When driving, always hold the steering wheel with both hands on the outside of the ring at the 9 o'clock and 3 o'clock positions. This reduces the risk of injury when the driver airbag is triggered.
- Never hold the steering wheel at the 12 o'clock position, or in any other manner [e.g. in the centre of the steering wheel]. In such cases, if the airbag is triggered, you may sustain injuries to the arms, hands and head.
- To reduce the risk of injury to the driver during sudden braking manoeuvres or an accident, never drive with the backrest tilted far back! The airbag system and seat belts can only provide optimal protection when the backrest is in an upright position and the driver is wearing his or her seat belt correctly.

- Adjust the head restraint properly to achieve optimal protection.

Adjusting the steering wheel position

Read the additional information carefully »  page 16.

⚠ WARNING

- Never adjust the position of the steering wheel when the vehicle is moving, as this could cause an accident.
- Move the lever up firmly so the steering wheel position does not accidentally change during driving. risk of accident!
- Make sure you are capable of reaching and firmly holding the upper part of the steering wheel: risk of accident!
- If you adjust the steering wheel so that it points towards your face, the driver airbag will not protect you properly in the event of an accident. Make sure that the steering wheel points towards your chest.

Correct position for the front passenger

For your own safety and to reduce the risk of injury in the event of an accident, we recom-

mend the following adjustments for the front passenger:

- Move the front passenger seat back as far as possible » 
- Move the seat backrest to an upright position so that your back rests completely against it.
- Adjust the head restraint so that its upper edge is at the same level as the top of your head, or as close as possible to the same level as the top of your head » page 61.
- Always keep both feet in the footwell in front of the front passenger seat.
- Fasten your seat belt securely » page 63.

It is possible to deactivate the front passenger airbag in **exceptional circumstances** » page 72.

Adjusting the front passenger seat »  page 14.

⚠ WARNING

- An incorrect sitting position of the front passenger can lead to severe injuries.
- Adjust the front passenger seat so that there is at least 25 cm between your chest and the dash panel. If you are sitting closer than 25 cm, the airbag system cannot protect you properly. »

- If your physical constitution prevents you from maintaining the minimum distance of 25 cm, contact a specialised workshop. The workshop will help you decide if special specific modifications are necessary.
- Always keep your feet in the footwell when the vehicle is moving; never rest them on the dash panel, out the window or on the seat. An incorrect sitting position exposes you to an increased risk of injury in case of a sudden braking or an accident. If the air-bag is triggered, you could sustain severe injuries due to an incorrect sitting position.
- To reduce the risk of injury to the front passenger in events such as sudden braking manoeuvres or an accident, never travel with the backrest tilted far back! The air-bag system and seat belts can only provide optimal protection when the backrest is in an upright position and the front passenger is wearing his or her seat belt properly. The further the seat backrests are tilted to the rear, the greater the risk of injury due to incorrect positioning of the belt web or to the incorrect sitting position!
- Adjust the head restraint correctly in order to achieve maximum protection.

Correct sitting position for rear seat passengers

To reduce the risk of injury in the event of a sudden braking manoeuvre or an accident,

passengers on the rear seat bench must consider the following:

- Sit up straight.
- Adjust the head restraint to the correct position »» page 62.
- Always keep both feet in the footwell in front of the rear seat.
- Fasten your seat belt securely »» page 63.
- Use an appropriate child restraint system when you take children in the vehicle »» page 75.

WARNING

- If the passengers in the rear seats are not sitting properly, they could sustain severe injuries.
- Adjust the head restraint correctly in order to achieve maximum protection.
- Seat belts can only provide optimal protection when seat backrests are in an upright position and the vehicle occupants are wearing their seat belts correctly. If passengers in the rear seats are not sitting in an upright position, the risk of injury due to incorrect positioning of the seat belt increases.

Examples of incorrect sitting positions

Seat belts can provide optimal protection only when the belt webs are properly positioned. Incorrect sitting positions substantially reduce the protective function of seat belts and increase the risk of injury due to incorrect seat belt position. As the driver, you are responsible for all passengers, especially children.

- Never allow anyone to assume an incorrect sitting position in the vehicle while travelling »» .

The following list contains examples of sitting positions that could be dangerous for all vehicle occupants. The list is not complete, but we would like to make you aware of this issue.

Therefore, whenever the vehicle is in motion:

- Never stand in the vehicle.
- Never stand on the seats.
- Never kneel on the seats.
- Never tilt your seat backrest far to the rear.
- Never lean against the dash panel.
- Never lie on the rear bench.
- Never sit on the front edge of a seat.
- Never sit sideways.
- Never lean out of a window.

- Never put your feet out of a window.
- Never put your feet on the dash panel.
- Never put your feet on the surface of a seat.
- Do not allow anyone to travel in the footwell.
- Never travel without wearing the seat belt.
- Do not allow anyone to travel in the luggage compartment.

⚠ WARNING

- Any incorrect sitting position increases the risk of severe injuries.
- Sitting in an incorrect position exposes the vehicle occupants to severe injuries if airbags are triggered, by striking a vehicle occupant who has assumed an incorrect sitting position.
- Before the vehicle moves, assume the proper sitting position and maintain it throughout the trip. Before every trip, instruct your passengers to sit properly and to stay in this position during the trip
»» page 58, Correct position of the vehicle occupants.

Correct adjustment of front head restraints

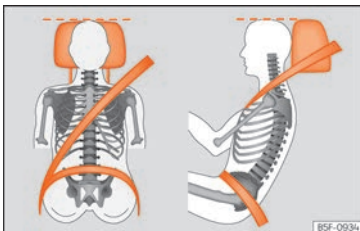

Fig. 74 Correctly adjusted head restraint as viewed from the front and the side.

Properly adjusted head restraints are an important part of passenger protection and can reduce the risk of injuries in most accident situations.

- Adjust the head restraint so that its upper edge is, as far as possible, at the same level as the top of your head, or at the very least, at eye level »» **Fig. 74**.

Adjusting the head restraints »» page 132

Active head restraints*

Vehicle occupants are pressed into their seats during a rear end collision. The resulting body pressure on the seat backrest activates the active head restraint* on the front seat, which moves rapidly forwards and upwards

at the same time. This movement reduces the distance between the occupant's head and the head restraint, thus reducing the risk of injuries such as whiplash.

⚠ WARNING

- Travelling with the head restraints removed or improperly adjusted increases the risk of severe injuries. An improper adjustment of the head restraints may cause death in an accident and increase the risk of suffering injuries during abrupt braking actions or unexpected manoeuvres.
- The head restraints must always be adjusted according to the height of the passenger.

i Note

The active head restraints* could also be triggered if a vehicle occupant applies a high level of pressure to the seat backrest (e.g. by "falling" back into the seat when entering the vehicle) or if pressure is applied to a front seat head restraint from the rear. This accidental activation is, however, not dangerous, as the active head restraints will return to the original position immediately and are thus once again ready.

Correct adjustment of rear head restraints

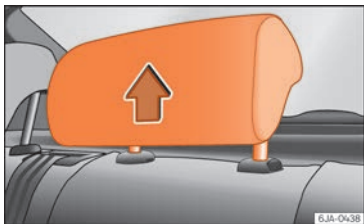

Fig. 75 Head restraints in the correct position.

Properly adjusted head restraints are an important part of passenger protection and can reduce the risk of injuries in most accident situations.

Rear outer seat head restraints

- The rear outer seat head restraints have 4 positions.
- Three positions for **use** »» Fig. 75. In these positions, the head restraints are used normally, and along with the rear seat belts, protect passengers in the rear seats.
- And one position for **non-use**.
- To fit the head restraints in position for use, pull on the edges with both hands in the direction of the arrow.

Centre rear head restraint*

- The centre head restraint only has two positions, **in-use** (head restraint up) and **non-use** (head restraint down).

⚠ WARNING

- Under no circumstances should the rear passengers travel while the head restraints are in the non-use position.
- Do not swap the centre rear head restraint with either of the outer seat rear head restraints. Risk of injury in case of an accident!

ⓘ CAUTION

Note the instructions on the adjustment of the head restraints »» page 132.

Pedal area

Pedals

- Ensure that you can always press the accelerator, brake and clutch pedals unimpaird to the floor.
- Ensure that the pedals can return unimpaird to their initial positions.
- Ensure that the floor mats are securely fastened during the trip and do not obstruct the pedals »» ⚠.

Only use floor mats which leave the pedals clear and which are secured to prevent them from slipping. You can obtain suitable floor mats from a specialised dealership. Fasteners* for floor mats are fitted in the footwells.

If a brake circuit fails, the brake pedal must be pressed down thoroughly in order to stop the vehicle.

Wear suitable footwear

Always wear shoes which support your feet properly and give you a good feeling for the pedals.

⚠ WARNING

- If the pedals are obstructed, an accident may occur. Risk of serious injuries.
- Never lay or fit floor mats or other floor coverings over the original floor mats. This would reduce the pedal area and could obstruct the pedals. Risk of accident.
- Never place objects in the driver footwell. An object could move into the pedal area and impair pedal operation. In the event of a sudden driving or braking manoeuvre, you will not be able to operate the brake, clutch or accelerator pedal. Risk of accident!

Seat belts

The whys and wherefores of seat belts

Number of seats

Your vehicle has **five** seats, two in the front and three in the rear. Each seat is equipped with a three-point seat belt.

In some versions, your vehicle is approved **only** for four seats. Two front seats and two rear seats.

WARNING

- Never transport more than the permitted amount of people in your vehicle.
- Every vehicle occupant must properly fasten and wear the seat belt belonging to his or her seat. Children must be protected with an appropriate child restraint system.

Seat belt control lamp*



It lights up red

Driver or passenger has not fastened seat belt.

The control lamp illuminates to remind the driver to fasten his seat belt.

Before starting the vehicle:

- Fasten your seat belt securely.
- Instruct your passengers to fasten their seat belts properly before driving off.
- Protect children by using a child seat according to the child's height and weight.

When starting to drive, if the vehicle's speed surpasses approx. 25 km/h (15 mph) and the seat belts are not fastened or are unfastened during the drive, a warning sound will be heard for a few seconds. The warning light will also flash .

The lamp  goes out when the driver and passenger seat belts are fastened with the ignition switched on.

The protective function of seat belts



Fig. 76 Drivers with properly worn seat belts will not be thrown forward in the event of sudden braking.

Properly worn seat belts hold the occupants in the proper position. They also help prevent uncontrolled movements that may result in serious injury and reduce the risk of being thrown out of the vehicle in case of an accident.

Vehicle occupants wearing their seat belts correctly benefit greatly from the ability of the belts to absorb kinetic energy. In addition, the front part of your vehicle and other passive safety features (such as the airbag system) are designed to absorb the kinetic energy released in a collision. Taken together, all these features reduce the releasing kinetic energy and consequently, the risk of injury. This is why it is so important to fasten seat



belts before every trip, even when "just driving around the corner".

Ensure that your passengers wear their seat belts as well. Accident statistics have shown that wearing seat belts is an effective means of substantially reducing the risk of injury and improving the chances of survival when involved in a serious accident. Furthermore, properly worn seat belts improve the protection provided by airbags in the event of an accident. For this reason, wearing a seat belt is required by law in most countries.

Although your vehicle is equipped with airbags, the seat belts must be fastened and worn. The front airbags, for example, are only triggered in some cases of head-on collision. The front airbags will not be triggered during minor frontal or side collisions, rear-end collisions, rollovers or accidents in which the airbag trigger threshold value in the control unit is not exceeded.

Therefore, you should always wear your seat belt and ensure that all vehicle occupants have fastened their seat belts properly before you drive off!

Important safety instructions for the use of seat belts

– Always wear the seat belt as described in this section.

– Ensure that the seat belts can be fastened at all times and are not damaged.

WARNING

- If seat belts are worn incorrectly or not at all, the risk of severe injuries increases. The optimal protection from seat belts can be achieved only if you use them properly.
- Fasten your seat belt before every trip - even when driving in town. Other vehicle occupants must also wear the seat belts at all times, otherwise they run the risk of being injured.
- The seat belt cannot offer its full protection if the seat belt is not positioned correctly.
- Never allow two passengers (even children) to share the same seat belt.
- Always keep both feet in the footwell in front of your seat as long as the vehicle is in motion.
- Never unbuckle a seat belt while the vehicle is in motion. Risk of fatal injury.
- The seat belt must never be twisted while it is being worn.
- The seat belt should never lie on hard or fragile objects (such as glasses or pens, etc.) because this can cause injuries.
- Do not allow the seat belt to be damaged or jammed, or to rub on any sharp edges.
- Never wear the seat belt under the arm or in any other incorrect position.

- Bulky and unfastened clothing (such as an overcoat over a sweater) impairs the proper fit and function of the seat belts, reducing their capacity to protect.
- The slot in the seat belt buckle must not be blocked with paper or other objects, as this can prevent the latch plate from engaging securely.
- Never use seat belt clips, fastening rings or similar items to alter the position of the belt webbing.
- Frayed or torn seat belts or damage to the connections, belt retractors or parts of the buckle could cause severe injuries in the event of an accident. Therefore, you must check the condition of all seat belts at regular intervals.
- Seat belts which have been worn in an accident and have been stretched must be replaced by a specialised workshop. Renewal may be necessary even if there is no apparent damage. The belt anchorage should also be checked.
- Do not attempt to repair a damaged seat belt yourself. The seat belts must not be removed or modified in any way.
- The belts must be kept clean, otherwise the retractors may not work properly
»» page 268.

Head-on collisions and the laws of physics

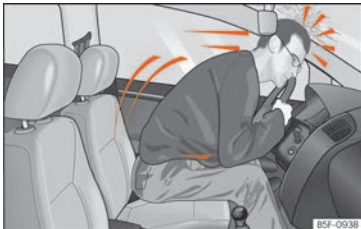

Fig. 77 A driver not wearing a seat belt is thrown forward violently.



Fig. 78 The unbelted passenger in the rear seat is thrown forward violently, hitting the driver wearing a seat belt

The effects of the laws of physics in the case of a head-on collision are easy to explain: the moment a vehicle starts moving, a type of en-

ergy called “kinetic energy” starts acting on both the vehicle and its passengers.

The amount of “kinetic energy” depends on the speed of the vehicle and on the weight of the vehicle and of its passengers. The higher the speed and the greater the weight, the more energy there is to be “absorbed” in an accident.

The most significant factor, however, is the speed of the vehicle. If the speed doubles from 25 km/h (15 mph) to 50 km/h (30 mph), for example, the corresponding kinetic energy is multiplied by four.

Because the vehicle occupants in our example are not restrained by seat belts, in the event of crashing against a wall, all of the occupants’ kinetic energy will be absorbed solely by said impact.

Even at speeds of 30 km/h (19 mph) to 50 km/h (30 mph), the forces acting on bodies in a collision can easily exceed one tonne (1000 kg). At greater speed these forces are even higher.

Vehicle occupants not wearing seat belts are not “attached” to the vehicle. In a head-on collision, they will move forward at the same speed their vehicle was travelling just before the impact. This example applies not only to head-on collisions, but to all accidents and collisions.

Even at low speeds the forces acting on the body in a collision are so great that it is not possible to brace oneself with one’s hands. In a frontal collision, unbelted passengers are thrown forward and will make violent contact with the steering wheel, dash panel, wind-screen or whatever else is in the way
» **Fig. 77.**

It is also important for rear passengers to wear seat belts properly, as they could otherwise be thrown forward violently through the vehicle interior in an accident. Passengers in the rear seats who do not use seat belts endanger not only themselves but also the front occupants » **Fig. 78.**

How to properly adjust your seat belt

Fastening and unfastening the seat belt

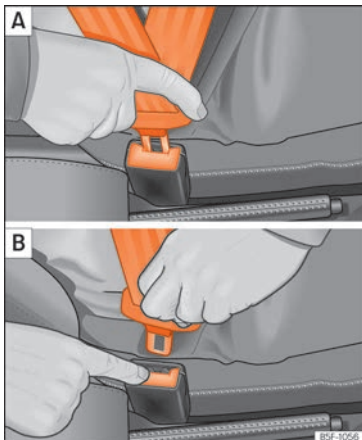

Fig. 79 Positioning and removing the seat belt buckle.



Fig. 80 Placing the seat belt in the shoulder and pelvis area for pregnant women.

Fasten your seat belt

The seat belt cannot offer its full protection if the seat belt is not positioned correctly.

- Adjust the seat and head restraint correctly.
- To fasten the belt, take hold of the latch plate and pull it slowly across your chest and lap.
- Insert the latch plate into the buckle for the appropriate seat and push it down until it is securely locked with an audible click
»» Fig. 79 A.
- Pull the belt to ensure that the latch plate is securely engaged in the buckle.

The seat belts are equipped with an automatic retractor on the shoulder strap. Full freedom of movement is permitted when the

shoulder belt is pulled slowly. However, during sudden braking, during travel in steep areas or bends and during acceleration, the automatic retractor on the shoulder belt is locked.

The automatic belt retractors on the front seats are fitted with seat belt tensioners
»» page 67.

Seat belt release

- Press the red button on the belt buckle
»» Fig. 79 B. The latch plate is released and springs out »» ⚠.
- Guide the belt back by hand so that it rolls up easily and the trim is not damaged.

Positioning seat belts

Seat belts offer their maximum protection only when they are properly positioned.

The following features are available to adjust the seat belt in the shoulder region:

- belt height adjustment for the front seats.
- front seat height adjustment*.

⚠ WARNING

- **The seat belts offer best protection only when the backrests are in an upright position and the seat belts have been fastened properly.**

- Never put the latch plate in the buckle of another seat. If you do this, the seat belt will not protect you properly and the risk of injury is increased.
- Never unbuckle a seat belt while the vehicle is in motion. If you do, you increase the risk of sustaining severe or fatal injuries.
- An incorrectly worn seat belt can cause severe injuries in the event of an accident.
- The shoulder part of the seat belt must lie on the centre of the shoulder, never across the neck. The seat belt must lie flat and fit comfortably on the torso
- The lap part of the seat belt must lie across the pelvis, never across the stomach. The seat belt must lie flat and fit comfortably on the pelvis Pull the belt tight if necessary to take up any slack.
- For pregnant women, the lap part of the seat belt must lie as low as possible over the pelvis, never across the stomach, and always lie flat so that no pressure is exerted on the abdomen »» Fig. 80.
- Always engage the retractor lock when you are securing a child seat in group 0, 0+ or 1 »» page 75.
- Read and observe the warnings »» page 64.

Belt height adjustment

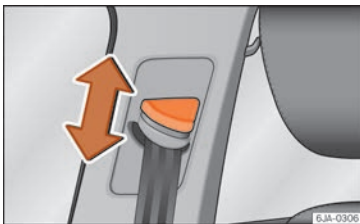

Fig. 81 Location of the belt height adjuster.

The seat belt adjuster for the front seats can be used to adjust the proper belt position at the shoulder.

- Press the upper part of the shoulder belt guide and hold it in this position »» **Fig. 81**.
- Move the shoulder belt guide up or down until you have adjusted the seat belt »» page 66.
- After adjusting, pull the shoulder belt sharply to check that the catch on the shoulder belt guide is engaged securely.

Seat belt tensioners

How the seat belt tensioner works

Read the additional information carefully »» page 15.

The seat belts for the occupants in the front seats are equipped with belt tensioners. Sensors will trigger the belt tensioners only during severe head-on, lateral and rear-end collisions and only if the seat belt is worn. This retracts and tightens the seat belts, reducing the forward motion of the occupants.

The belt tensioners will not be triggered in the event of minor collisions, if the vehicle overturns, or in accidents where no major forces act on the vehicle.

Note

- If the seat belt tensioners are triggered, a fine dust is produced. This is normal and it is not an indication of fire in the vehicle.
- The relevant safety requirements must be observed when the vehicle or components of the system are scrapped. Specialised workshops are familiar with these regulations, which are also available to you.

Maintenance and disposal of belt tensioners

The belt tensioners are components of the seat belts that are installed in the seats of your vehicle. If you work on the belt tensioners or remove and install parts of the system when performing other repair work, the seat belt may be damaged. The consequence may be that, in the event of an accident, the belt tensioners function incorrectly or may not function at all.

So that the effectiveness of the seat belt tensioner is not reduced and that removed parts do not cause any injuries or environmental pollution, regulations, which are known to the specialised workshops, must be observed.

WARNING

- **Improper use or repairs not carried out by qualified mechanics increase the risk of severe or fatal injuries. The belt tensioners may fail to trigger or may trigger in the wrong circumstances.**
- **Never attempt to repair, adjust, remove or install parts of the belt tensioners or seat belts.**
- **The seat belt tensioner, seat belt and automatic retractor cannot be repaired.**
- **Any work on the belt tensioners and seat belts, including the removal and refitting of system parts in conjunction with other re-**

pair work, must be performed by a specialised workshop only.

- **The belt tensioners will only provide protection for one accident and must be changed if they have been activated.**

Airbag system

Brief introduction

Why is it so important to wear a seat belt and to sit correctly?

For the inflating airbags to achieve the best protection, the seat belt must always be worn properly and the correct sitting position must be assumed.

The airbag system is not a substitute for seat belts, but it is an integral part of the vehicle's overall passive safety system. Please bear in mind that the airbag system can only work effectively when the vehicle occupants are wearing their seat belts correctly and have adjusted the head restraints properly. Therefore, it is most important to wear the seat belts at all times, not only because this is required by law in most countries, but also for your safety »» page 63, **The whys and wherefores of seat belts.**

The airbag inflates in a matter of seconds, so if you are not properly seated when the airbag is triggered, you may sustain fatal injuries. Therefore, it is essential that all vehicle occupants assume a correct sitting position while travelling.

Sharp braking before an accident may cause a passenger not wearing a seat belt to be

thrown forward into the area of the deploying airbag. In this case, the inflating airbag may inflict critical or fatal injuries on the occupant. This also applies to children.

Always maintain the greatest possible distance between yourself and the front airbag. This way, the front airbags can completely deploy when triggered, providing their maximum protection.

The most important factors for triggering the airbag are the type of accident, the angle of impact and the vehicle speed.

Whether or not the airbags are triggered depends primarily on the vehicle deceleration rate resulting from the collision and detected by the control unit. If the vehicle deceleration occurring during the collision and measured by the control unit remains below the specified reference values, the front, side and/or curtain airbags will not be triggered. Take into account that the visible damage in a vehicle involved in an accident, no matter how serious, is not a determining factor for the airbags to have been triggered.

WARNING

- **Wearing the seat belt incorrectly or assuming an incorrect sitting position can lead to critical or fatal injuries.**
- **All vehicle occupants, including children, who are not properly belted can sustain critical or fatal injuries if the airbag is trig-**

gered. Children up to 12 years old should always travel on the rear seat. Never transport children in the vehicle if they are not restrained or the restraint system is not appropriate for their age, size or weight.

- **If you are not wearing a seat belt, or if you lean forward or to the side while traveling or assume an incorrect sitting position, there is a substantially increased risk of injury. This increased risk of injury will be further increased if you are struck by an inflating airbag.**
- **To reduce the risk of injury from an inflating airbag, always wear the seat belt properly »» page 63.**
- **Always adjust the front seats properly.**

Description of airbag system

The airbag system mainly comprises (as per vehicle equipment):

- an electronic control and monitoring system (control unit)
- frontal airbags for driver and passenger,
- side airbags,
- curtain airbags,
- a control lamp  on the dash panel »» page 73.
- key-operated switch for front passenger airbag,

- a control lamp for disabling/enabling the front passenger airbag.

The airbag system operation is monitored electronically. The airbag control lamp will illuminate for a few seconds every time the ignition is switched on (self-diagnosis).

There is a fault in the system if the control lamp :

- does not light up when the ignition is switched on »» page 73,
- turns off after 4 seconds after the ignition is switched on,
- turns off and then lights up again after the ignition is switched on,
- illuminates or flashes while the vehicle is moving.

The airbag system is not triggered if:

- the ignition is switched off
- there is a minor frontal collision
- there is a minor side collision
- there is a rear-end collision
- the vehicle turns over.

WARNING

- **The seat belts and airbags can only provide maximum protection if the occupants are seated correctly »» page 58, Correct position of the vehicle occupants.**

»

- If a fault has occurred in the airbag system, have the system checked immediately by a specialised workshop. Otherwise, during a frontal collision the system might not trigger correctly or may fail to trigger at all.

Airbag activation

The airbags deploy extremely rapidly, within thousandths of a second, to provide additional protection in the event of an accident. A fine dust may develop when the airbag deploys. This is normal and it is not an indication of fire in the vehicle.

The airbag system is only ready to function when the ignition is on.

In special accidents instances, several airbags may activate at the same time.

In the event of minor head-on and side collisions, rear-end collisions, overturning or roll-over of the vehicle, airbags **do not activate**.

Activation factors

The conditions that lead to the airbag system activating in each situation cannot be generalised. Some factors play an important role, such as the properties of the object the vehicle hits (hard/soft), angle of impact, vehicle speed, etc.

Deceleration trajectory is key for airbag activation.

The control unit analyses the collision trajectory and activates the respective restraint system.

If the deceleration rate is below the predefined reference value in the control unit the airbags will not be triggered, even though the accident may cause extensive damage to the car.

The following airbags are triggered in serious head-on collisions:

- Driver airbag.
- Front passenger front airbag

The following airbags are triggered in serious side-on collisions:

- Front side airbag on the side of the accident.
- Rear side airbag on the side of the accident.
- Curtain (head) airbag on the side of the accident.

In an accident with airbag activation:

- the interior lights switch on (if the interior light switch is in the courtesy light position);
- the hazard warning lights switch on;
- all doors are unlocked;

- the fuel supply to the engine is cut.

Airbag safety instructions

Front airbags

Read the additional information carefully »  page 16.

WARNING

- The deployment space between the front passengers and the airbags must not in any case be occupied by other passenger, pets and objects.
- The airbags provide protection for just one accident; replace them once they have deployed.
- It is also important not to attach any objects such as cup holders or telephone mountings to the surfaces covering the airbag units.
- Do not attempt to modify components of the airbag system in any way.
- When driving, always hold the steering wheel with both hands on the outside part at the 9 o'clock and 3 o'clock positions. Never hold the steering wheel at the 12 o'clock position, or in any other manner (e.g. in the centre of the steering wheel). In such cases, if the airbag is triggered, you may sustain injuries to the arms, hands and head.

Side airbags*

Read the additional information carefully
 »»  page 18.

⚠ WARNING

- If you do not wear a seat belt, if you lean forward, or are not seated correctly while the vehicle is in motion, you are at a greater risk of injury if the side airbag system is triggered in an accident.
- In order for the side airbags to provide their maximum protection, the prescribed sitting position must always be maintained with seat belts fastened while travelling.
- Occupants of the outer seats must never carry any objects or pets in the deployment space between them and the airbags, or allow children or other passengers to travel in this position. It is also important not to attach any accessories (such as cup holders) to the doors. This would impair the protection offered by the side airbags.
- The built-in coat hooks should be used only for lightweight clothing. Do not leave any heavy or sharp-edged objects in the pockets.
- Great forces, such as hard blows or kicks, must not be exerted upon the backrest bolster because the system may be damaged. In this case, the side airbags would not be triggered.
- Under no circumstances should protective covers be fitted over seats with side

airbags unless the covers have been approved for use in your vehicle. Because the airbag deploys from the side of the backrest, the use of conventional seat covers would obstruct the side airbag, seriously reducing the airbag's effectiveness.

- Any damage to the original seat upholstery or around the seams of the side airbag units must be repaired immediately by a specialised workshop.
- The airbags provide protection for just one accident; replace them once they have deployed.
- Any work on the side airbag system or removal and installation of the airbag components for other repairs (such as removal of the front seat) should only be performed by a specialised workshop. Otherwise, faults may occur during the airbag system operation.
- Do not attempt to modify components of the airbag system in any way.
- The side and head airbags are managed through sensors located in the interior of the front doors. To ensure the correct operation of the side and curtain (head) airbags neither the doors nor the door panels should be modified in any way (e.g. fitting loudspeakers). If the front door is damaged, the airbag system may not work correctly. All work carried out on the front door must be done in a specialised workshop.
- In a side-on collision the side airbags will not work if the sensors do not correctly

measure the pressure increase on the interior of the doors, due to air escaping through the areas with holes or openings in the door panel.

- Never drive the vehicle if the interior panels have been removed.
- Never drive if the interior door panels have been removed or if the panels have not been correctly fitted.
- Never drive the vehicle if the loudspeakers in the door panels have been removed, unless the holes left by the loudspeakers have been closed properly.
- Always check that the openings are closed or covered if loudspeakers or other equipment are fitted inside the door panels.
- Any work carried out to the doors should be made in an authorised specialised workshop.

Head-protection airbags*

Read the additional information carefully
 »»  page 18.

⚠ WARNING

- In order for the head-protection airbags to provide their maximum protection, the prescribed sitting position must always be maintained with seat belts fastened while travelling.

- For safety reasons, the curtain airbag must be disabled in those vehicles fitted with a screen dividing the interior of the vehicle. See your technical service to make this adjustment.
- There must be no other persons, animals or objects between the occupants of the rear seats and the deployment space of the head-protection airbags so that the head-protection airbag can deploy without restriction and provide the greatest possible protection. Therefore, sun blinds which have not been expressly approved for use in your vehicle may not be attached to the side windows
- The built-in coat hooks should be used only for lightweight clothing. Do not leave any heavy or sharp-edged objects in the pockets. Please, do not hang the clothes on coat hangers.
- The airbags provide protection for just one accident; replace them once they have deployed.
- Any work on the head-protection airbag system or removal and installation of the airbag components for other repairs (such as removal of the roof lining) should only be performed by a specialised workshop. Otherwise, faults may occur during the airbag system operation.
- Do not attempt to modify components of the airbag system in any way.
 - The side and head airbags are managed through sensors located in the interior of

the front doors. To ensure the correct operation of the side and curtain airbags neither the doors nor the door panels should be modified in any way (e.g. fitting loudspeakers). If the front door is damaged, the airbag system may not work correctly. All work carried out on the front door must be done in a specialised workshop.

Deactivating airbags

Introduction

The disabling of airbags is only carried out in certain cases, i.e. if:

- a child seat is required in the front passenger seat with the child facing in the opposite direction to the direction of travel (in some countries, due to divergent legal requirements, facing in the direction of travel) » page 76;
- despite the driver's seat being in the correct position, a minimum distance of 25 cm cannot be maintained between the centre of the steering wheel and the driver's torso,
- installation of special devices is required in the steering wheel area due to a physical disability,
- if you have special seats installed (e.g. an orthopaedic seat without side airbags).

The front passenger front airbag can be disabled using the switch » page 73.

We recommend that you contact an authorised SEAT dealer for the disabling of other airbags.



Airbag system control

The airbag system availability is controlled electronically, regardless of whether an airbag is disabled.

If an airbag was disabled using a diagnostics system:

- the airbag system warning lamp  illuminates after switching on the ignition for about 4 seconds, and then flashes for about 12 seconds.

If the airbag has been disabled with the airbag switch on the side of the dash panel:

- the airbag control lamp  will illuminate for about 4 seconds after the ignition is switched on,
- the airbag is disabled, signalled with the warning lamp OFF , which lights up with the word **PASSENGER AIR BAG OFF** , placed in the centre part of the dash panel » Fig. 82 ③.

Note

- Follow the current legislation in your country regarding the disabling of airbags.

- At your authorised SEAT dealer you can find information on which vehicle airbags can be disabled.

Switch front passenger front airbag on and off



Fig. 82 Front passenger front airbag switch/warning lamp for disabling the front passenger airbag.

Read the additional information carefully

»»» page 17.

The switch disables only the front passenger front airbag.

Switching on the airbag

- Switch the ignition off.
- Open the passenger side storage compartment.
- Insert the key into the slot of the switch for deactivating the front passenger airbag »»» **Fig. 82**. About 3/4 of the key should enter, as far as it will go.
- Then turn the key gently to the **ON** position. Do not force it if you feel resistance, and make sure you have inserted the key fully.
- Close the passenger side storage compartment.
- Check, with the ignition switched on, that the **OFF** control lamp does not illuminate, with the words **PASSENGER AIR BAG OFF** in the centre of the dash panel.

Control lamp with the word PASSENGER AIR BAG OFF (front passenger airbag disabled)

If the front passenger front airbag is **disabled**, after switching on the ignition, the control lamp will illuminate for several seconds, then it will switch off for about 1 s and then switch on again.

If the control lamp is flashing, there is a fault in the disabling of the airbag system »»» . **Please go immediately to an Official Service.**

WARNING

- The driver of the vehicle is responsible for disabling or switching on the airbag.
- Always switch off the ignition before disabling the front passenger airbag! Failure to do so could result in a fault in the airbag disabling system.
- Never leave the key in the airbag disabling switch as it could get damaged or enable or disable the airbag during driving.
- If the **OFF** (airbag disabled) control lamp flashes, the front passenger front airbag will not trigger in the event of an accident! Have the system immediately checked by an Official Service.

Airbag and seat belt tensioner control lamp



It lights up on the combi-instrument

Fault in airbag system and seat belt tensioners. Have the system checked immediately by a specialised workshop. »»

OFF  It lights up on the dash panel

Front passenger front airbag disabled.
Check whether the airbag should remain disabled

The control lamp monitors all airbags and seat belt tensioners in the vehicle, including control units and wiring connections.

Monitoring of airbag and belt tensioner system

Both the airbag and belt tensioner systems operation is constantly monitored electronically. Each time the ignition is switched on, the control lamp  illuminates for several seconds (self-diagnosis) and the instrument panel display* shows **AIRBAG/TENSIONER**.

The system must be checked when the control lamp  :

- does not light up when the ignition is switched on,
- turns off after 4 seconds after the ignition is switched on,
- turns off and then lights up again after the ignition is switched on,
- illuminates or flashes while the vehicle is moving.

In the event of a malfunction, the warning lamp stays on continuously. In addition, depending on the malfunction, a fault message appears on the instrument panel display for

approximately 10 seconds and a short audible warning is given. In this event, you should have a specialised workshop check the system immediately.



The airbag system availability is controlled electronically, regardless of whether an airbag is disabled.

If the front airbag, side airbag, head protection airbag or the belt tensioner are disabled using the diagnostics system:

- After switching on the ignition, the  warning lamp illuminates for about 4 seconds and flashes for another 12 seconds.

The informative display indicates:

Airbag/belt tensioner disabled!**If the front passenger airbag has been disabled with the airbag switch located in the storage compartment side:**

- When the ignition is turned on, the  warning lamp illuminates for about 4 seconds.
- The airbag is disabled, signalled with the warning lamp **OFF **, which lights up with the word **PASSENGER AIR BAG OFF **, placed in the centre part of the dash panel »» **Fig. 82** »» page 73.

- If a malfunction occurs, have the system checked immediately by a specialised workshop. Otherwise, in the event of an accident, the airbag system and belt tensioners may not be triggered, or may not be triggered correctly.

 WARNING

- If there is a malfunction, the airbag and belt tensioner system cannot properly perform its protective function.

Transporting children safely

Safety for children

Introduction

For safety reasons, as we have learned from accident statistics, we recommend that children under 12 years of age travel in the rear seats. Depending on their age, height and weight, children travelling in rear seats must use a child seat or a seat belt. For safety reasons, the child seat should be installed in the rear seat, behind the front passenger seat or in the centre back seat.

The physical laws involved and the forces acting in a collision apply also to children »» page 65. But unlike adults, children do not have fully developed muscle and bone structures. This means that children are subject to a greater risk of injury.

To reduce the risk of injuries, children must always use special child restraint systems when travelling in the vehicle.

We recommend the use of child safety products from the SEAT Original Accessories Programme, which includes systems for all ages made by "Peke" (not for all countries).

These systems have been especially designed and approved, complying with the ECE-R44. regulation.

Follow the manufacturer's instructions and observe any statutory requirements when installing and using child seats. Always read and note »» page 75.

We recommend you always carry the manufacturer's Child Seat Instruction Manual together with the on-board documentation.

Important information regarding the front passenger's airbag

Read the additional information carefully »»  page 19.

Read and always observe the safety information included in the following chapters:

- Safety distance with respect to the passenger airbag »» page 68, **Why is it so important to wear a seat belt and to sit correctly?**
- Objects between the passenger and the passenger side airbag »»  in **Front airbags on page 70.**

The passenger side front airbag, when enabled, is a serious risk for a child that is facing backward since the airbag can strike the seat with such force that it can cause serious or

fatal injuries. Children up to 12 years old should always travel on the rear seat.

Therefore we strongly recommend you to transport children on the rear seats. This is the safest location in the vehicle. Alternatively, the front passenger airbag can be disabled with a key-operated switch »» page 72. When transporting children, use a child seat suitable for the age and size of each child »» page 75.

WARNING

- If a child seat is secured to the front passenger seat, the risk to the child of sustaining critical or fatal injuries in the event of an accident increases.
- An inflating front passenger airbag can strike the rear-facing child seat and project it with great force against the door, the roof or the backrest.
- Never install a child seat facing backwards on the front passenger seat unless the front passenger front airbag has been disabled. Risk of potentially fatal injuries to the child! However, if it is necessary, in exceptional cases, to transport a child in the front passenger seat, the front passenger front airbag must always be disabled »» page 72. If the front passenger seat has a height adjustment option, move it to the highest position.
- For those vehicles that do not include a key lock switch to deactivate the airbag, »»

the vehicle must be taken to a technical service.

- All vehicle occupants, especially children, must assume the proper sitting position and be properly belted in while traveling.
- Never hold children or babies on your lap, this can result in potentially fatal injuries to the child!
- Never allow a child to be transported in a vehicle without being properly secured, or to stand up or kneel on a seat while traveling. In an accident, the child could be flung through the vehicle, causing possibly fatal injuries to themselves and to the other vehicle occupants.
- If children assume an improper sitting position when the vehicle is moving, they expose themselves to greater risk of injury in the event of a sudden braking manoeuvre or in an accident. This is particularly important if the child is travelling on the front passenger seat and the airbag system is triggered in an accident; as this could cause serious injury or even death.
- A suitable child seat can protect your child!
- Never leave a child alone in the child seat or inside the vehicle because depending on the season, very high temperatures may be reached inside a parked vehicle, which could be fatal.

- Children who are less than 1.5 metres tall must not wear a normal seat belt without a child seat, as this could cause injuries to the abdominal and neck areas during a sudden braking manoeuvre or in an accident.
- Only one child may occupy a child seat
»» page 76, Child seats.

Child seats

Safety instructions

Read the additional information carefully
»»  page 19.

WARNING

- When travelling, children must be secured in the vehicle with a restraint system suitable for age, weight and size.
- Read and always observe information and warnings concerning the use of child seats »» page 75.

WARNING

- The retaining rings are designed only for use with "ISOFIX" and Top Tether* system child seats.
- Never secure other child seats that do not have the "ISOFIX" or Top Tether* system, or retaining belts or objects to the fas-

tening rings - this can result in potentially fatal injuries to the child.

- Ensure that the child seat is secured correctly using the "ISOFIX" and Top Tether* securing rings.

Categorisation of child seats into groups

Use only child seats that are officially approved and suitable for the child.

Child seats are subject to the regulation ECE-R 44. ECE-R stands for: European Economic Commission.

The child seats are grouped into 5 categories:

Group 0 Up to 10 kg (up to around 9 months)

Group 0+ Up to 13 kg (up to around 18 months)

Group 1 from 9 to 18 kg (up to approx. 4 years old)

Group 2 from 15 to 25 kg (up to approx. 7 years old)

Group 3 from 22 to 36 kg (up to approx. 7 years old)

Child seats that have been tested and approved under the ECE R44 standard bear the test mark on the seat (the letter E in a circle with the test number below it).

Follow the manufacturer's instructions and observe any statutory requirements when installing and using child seats.

We recommend you to always include the manufacturer's Child Seat Instruction Manual together with the on-board documentation.

SEAT recommends you use child seats from the **Original Accessories Catalogue**. These child seats have been designed and tested for use in SEAT vehicles. You can find the right child seat for your model and age group at SEAT dealers.

WARNING

Read and always observe information and warnings concerning the use of child seats
»» page 75.

Emergencies

Self-help

Emergency equipment

First-aid kit and warning triangle*



Fig. 83 Location of the warning triangle.

The warning triangle, measuring max. 436 x 45 x 32 mm, can be secured to the lining on the rear of the luggage compartment with rubber straps »» Fig. 83.

WARNING

The first-aid kit and fire extinguisher must be properly secured so that they are not catapulted through the vehicle during driving and braking manoeuvres or in the event of an accident. Risk of injury.

Note

- Observe the expiry date of the contents of the first aid kit.
- We recommend you use the first-aid kit and the warning triangle from the SEAT Original Accessories programme available in authorised SEAT dealers.

Fire extinguisher*

Read the instructions given on the fire extinguisher carefully.

The fire extinguisher must be checked once a year by an authorised person (take the applicable legal regulations into account).

WARNING

The fire extinguisher must be properly secured so that it is not catapulted through the vehicle, causing injuries, during driving and braking manoeuvres or in the event of an accident.

Note

- The fire extinguisher must comply with local legal requirements.
- Observe the expiry date of the fire extinguisher. The fire extinguisher may not work properly if used after the expiry date.

Vehicle tool kit*

Read the additional information carefully »» page 48

WARNING

- The factory-supplied jack is only designed for changing wheels on this model of vehicle. On no account attempt to use it for lighting heavier vehicles or other loads. Risk of injury!
- Make sure that the vehicle tools are stored properly in the luggage compartment.

Note

- Make sure the box always remains strapped to the spare wheel with tape.
- The jack does not generally require any maintenance. If required, it should be greased using universal type grease.

Changing a wheel

Introduction

Read the additional information carefully »» page 48

⚠ WARNING

- If you have a puncture in moving traffic, switch on the hazard warning lights and place the warning triangle at the obligatory distance. Observe applicable local legal regulations. This is for your own safety and that of other drivers.
- If you have a flat tyre, stop the vehicle as far away as possible from moving traffic. Stop on flat, solid ground.
- If you have to change the tyre on a gradient, block the wheel opposite the wheel being changed by placing a stone or similar object under it to prevent the vehicle from rolling away unexpectedly.
- If the vehicle has been fitted with tyres or alloys that are different to those fitted in manufacture, the instructions »» page 258, New tyres or wheels must be followed.
- Always raise the vehicle with the doors closed.
- Never place parts of your body, e.g. arms and legs, underneath the vehicle when it is supported only by the jack.
- Secure the base of the jack with suitable supports so that it cannot slip. The jack could slide if the ground below it is soft and slippery and the vehicle could slip off it. Therefore, place the jack on a firm surface or use a large, stable base. On a slippery surface, e.g. tile, use a non-slip base such as a rubber mat.

- Never start the engine when the vehicle is jacked. Risk of injury.
- The jack should only be used in the correct jacking points.

ⓘ CAUTION

- The prescribed tightening torque for wheel bolts on steel and alloy wheels is 120 Nm.
- If the anti-theft wheel bolt is overly tightened, this could damage the bolt and the adapter.

ⓘ Note

- The set of anti-theft wheel bolts or the adapter are available from authorised SEAT dealers.
- Please observe the relevant local legal regulations when changing the wheel.

Wheel bolts

The **wheel bolts** are matched to the rims. When installing different wheels, e.g. to fit light alloy wheels or wheels with winter tyres, it is important to use the correct wheel bolts with the right length and correctly shaped bolt heads. This is essential for a secure fit of the wheels and for proper operation of the brake system.

ⓘ Note

- Never grease or oil the wheel bolts!
- If the wheel bolt is very tight, it may be possible to loosen it by pushing down the end of the box spanner carefully with your foot. Hold on to the vehicle for support and take care not to slip.
- If you notice that the wheel bolts are rusty and difficult to turn when changing a wheel, they must be replaced before having the tightening torque checked.

Tyre repairs**TMS Anti-puncture kit (Tyre Mobility System)***

Read the additional information carefully »»  page 47

The Tyre Mobility System is stored in a box under the carpet in the boot.

Using the Tyre Mobility System you can reliably seal tyres damaged by foreign bodies, provided that cuts or punctures are no larger than approx. 4 mm in diameter. Do not remove the foreign bodies, e.g. bolts or nails, from the tyre!

The tyre must be repaired immediately. »

The repair made using the Tyre Mobility System **under no circumstances replaces** permanent tyre repair and should only be used to drive to the nearest official service.

The Tyre Mobility System kit shall not be used:

- If the wheel rim has been damaged,
- when the outside temperature is below -20°C [-4°F],
- on slashes or punctures larger than 4 mm,
- if the sidewall of the wheel has been damaged,
- If you have been driving with very low tyre pressure or a completely flat tyre
- If the best-before date on the air can has expired

⚠ WARNING

Using the tyre mobility system can be dangerous, especially when filling the tyre at the roadside. Please observe the following rules to minimise the risk of injury:

- Stop the vehicle safely as soon as possible. Park it at a safe distance from surrounding traffic to fill the tyre.
- Ensure the ground on which you park is flat and solid.
- All passengers and particularly children must keep a safe distance from the work area.

- Turn on the hazard warning lights to warn other road users.
- Use the tyre mobility system only if you are familiar with the necessary procedures. Otherwise, you should seek professional assistance.
- The tyre mobility set is intended for temporary emergency use only until you can reach the nearest specialised workshop.
- Replace the repaired tyre with the tyre mobility set as soon as possible.
- The sealant is a health hazard and must be cleaned immediately if it comes into contact with the skin.
- Always keep the tyre mobility set out of the reach of small children.
- Always stop the engine, apply the hand-brake lever firmly and engage gear if using a manual gearbox, in order to reduce the risk of vehicle involuntary movement.

⚠ WARNING

A tyre filled with sealant does not have the same performance properties as a conventional tyre.

- Never drive faster than 80 km/h (50 mph).
- Avoid heavy acceleration, hard braking and fast cornering.
- Drive for only 10 minutes at a maximum speed of 80 km/h (50 mph) and then check the tyre.

🌱 For the sake of the environment

Dispose of used or expired sealant observing any legal requirements.

📄 Note

- A new bottle of sealant can be purchased at SEAT dealerships.
- Take into account the separate instruction manual of the tyre mobility set* manufacturer.

Components of the tyre mobility set*

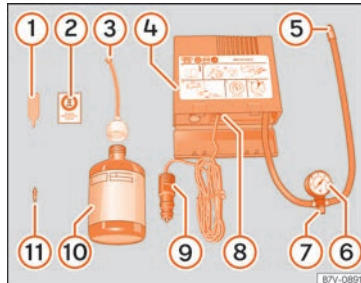

Fig. 84 Standard display: contents of the anti-puncture kit.

The anti-puncture kit is located underneath the floor covering in the luggage

compartment. It includes the following components »» Fig. 84:

- ① Tyre valve remover
- ② A sticker to be adhered to the instrument cluster, within the driver's visual field, to remind that the maximum advisable speed "max. 80 km/h" or "max. 50 mph"
- ③ Filler tube with cap
- ④ Air compressor
- ⑤ Tube for inflating tyres
- ⑥ Warning provided by tyre pressure monitoring system (it can also be integrated in the compressor).
- ⑦ Air bleed screw (in its place, the compressor may have a button).
- ⑧ ON/OFF switch
- ⑨ 12 volt connector
- ⑩ Bottle of sealant
- ⑪ Spare tyre valve

The **valve insert remover** ① has a gap at the lower end for a valve insert. The valve insert can only be screwed or unscrewed in this way. This also applies to its replacement part ⑪.

WARNING

When inflating the wheel, the air compressor and the inflator tube may become hot.

- Protect hands and skin from hot parts.

- Do not place the hot flexible inflator tube or hot air compressor on flammable material.
- Allow them to cool before storing the device.
- If it is not possible to inflate the tyre to at least 2.0 bars (29 psi / 200 kPa), the tyre is too badly damaged. The sealant is not in a good condition to seal the tyre. Do not continue driving. Seek specialist assistance.

CAUTION

Switch off the air compressor after a maximum of 8 operational minutes to avoid overheating! Before switching on the air compressor again, let it cool for several minutes.

Check after 10 minutes of driving

Screw the inflator tube »» Fig. 84 ⑤ again and check the pressure on the gauge ⑥.

1.3 bar (19 psi / 130 kPa) and lower:

- **Stop the vehicle!** The tyre cannot be sealed sufficiently with the tyre mobility set.
- You should obtain professional assistance »» 

1.4 bar (20 psi / 140 kPa) and higher:

- Set the tyre pressure to the correct value again.
- Carefully resume your journey until you reach the nearest specialised workshop without exceeding 80 km/h (50 mph).
- Have the damaged tyre replaced.

WARNING

Driving with an unsealed tyre is dangerous and can cause accidents and serious injury.

- Do not continue driving if the tyre pressure is 1.3 bar (19 psi / 130 kPa) and lower.
- Seek specialist assistance.

Towing the vehicle

Introduction

Read the additional information carefully »»  page 52.

Vehicles with manual gearbox can be towed using a towbar or towrope. They can also be towed with either the front or rear wheels lifted off the road.

Vehicles with automatic gearbox can be towed using a towbar or towrope. They can also be towed with the front wheels lifted off the »

road. If the vehicle is towed with the rear wheels lifted off the road the automatic gearbox will be damaged!

Maximum towing speed is **50 km/h (31 mph)**.

ⓘ CAUTION

- Do not tow-start the engine. Risk of engine damage! In vehicles with a catalytic converter, fuel that has not been burned could reach the catalytic converter and catch fire in it. This could damage and destroy the catalytic converter. You may use the battery from another vehicle to help you start your engine »» » page 54.
- If, due to a fault, there is no oil in the gearbox, the car may only be towed with the driven wheels lifted clear of the road and transported on a special vehicle transporter or trailer.
- If normal towing is not possible or if the vehicle is to be towed for further than 50 km, the vehicle must be transported on a special vehicle transporter or trailer.
- The towrope should be slightly elastic to reduce the load on both vehicles during towing. It is advisable to use a towrope made of synthetic fibre or similar material only.
- Do not pull too hard with the towing vehicle and always take care to avoid jerking the towrope. When towing on a loose surface there is always a risk of overloading and damaging the anchorage points.

- Attach the towrope or towbar only to the towline anchorages or to the removable towing bracket »» » page 232, or »» » page 82.

ⓘ Note

- We recommend you use the towrope or towbar available in the SEAT Original Accessories programme from authorised SEAT dealers.
- Towing a vehicle requires a certain degree of practical skill. Both drivers should be familiar with the technique required for towing. Inexperienced drivers should not attempt to tow away another vehicle or to have their vehicle towed.
- Note the legal regulations concerning towing, particularly those regarding the signalling of the towed and towing vehicle.
- The towrope must not be twisted, as under certain circumstances this could unscrew the front towline anchorage.

Anchoring the front tow line

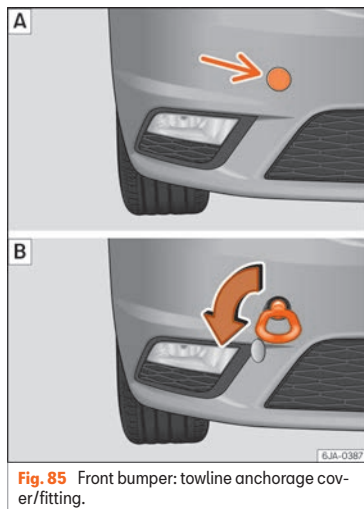

Fig. 85 Front bumper: towline anchorage cover/fitting.

Fitting and detaching the cover

- Press on the left of the cover as indicated by the arrow »» » Fig. 85 A.
- Pull on the cover to remove it from the front bumper.
- To refit the cover after unscrewing the towline anchorage, fit the cover and press

down on its right-hand side. The cover must be securely engaged.

Fitting and detaching the towline anchorage

- Screw in the towline anchorage anti-clockwise by hand as far as it will go »» Fig. 85 [B].

To tighten the towline anchorage, we recommend using the box spanner, the towing eye from another vehicle or a similar object that can be inserted through the anchorage.

- Unscrew the towline anchorage by turning it clockwise.

ⓘ CAUTION

The towline anchorage must be screwed in as far as it will go. Otherwise there is a risk of the screw connection shearing off during towing or tow-starting!

Fuses and bulbs

Fuses

Introduction

Due to the constant updating of vehicles, fuse assignments based on equipment and the use of the same fuse for various electrical components, it is not possible to provide an up-to-date summary of the fuse positions for the electrical components at the time this manual was printed. For detailed information about the fuse positions, please consult a technical service.

In general, a fuse can be assigned to various electrical components. Likewise, an electrical component can be protected by several fuses.

Only replace fuses when the cause of the problem has been solved. If a newly inserted fuse blows after a short time, you must have the electrical system checked by a specialised workshop as soon as possible.

Additional information and warnings:

- Working in the engine compartment »» page 244.

⚠ WARNING

The high voltages in the electrical system can give serious electrical shocks, causing burns and even death!

- Never touch the electrical wiring of the ignition system.
- Take care not to cause short circuits in the electrical system.

⚠ WARNING

Using unsuitable fuses, repairing fuses or bridging a current circuit without fuses can cause a fire and serious injury.

- Never use a fuse with a higher value. Only replace fuses with a fuse of the same amperage (same colour and markings) and size.
- Never repair a fuse.
- Never replace a fuse by a metal strip, staple or similar.

ⓘ CAUTION

- To prevent damage to the vehicle's electric system, before replacing a fuse always turn off the ignition, the lights and all electrical elements and remove the key from the ignition.
- If you replace a fuse with higher-rating fuse, you could cause damage to another part of the electrical system. »»

- Protect the fuse boxes when open to prevent the entry of dust or humidity as they can damage the electrical system.
- Always carefully remove the fuse box covers and refit them correctly to avoid problems with your vehicle.

i Note

- One component may have more than one fuse.
- Several components may run on a single fuse.
- In the vehicle, there are more fuses than those indicated in this chapter. These should only be changed by a specialised workshop.
- Positions not containing a fuse do not appear in the following tables.
- Some of the equipment listed in the tables below pertain only to certain versions of the model or are optional extras.
- Please note that the above lists, while correct at the time of printing, are subject to change.

Fuses in the dash panel

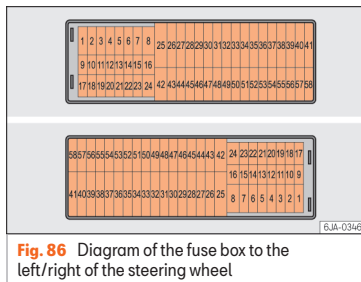

Fig. 86 Diagram of the fuse box to the left/right of the steering wheel

Read the additional information carefully

»» page 45

Only replace fuses with a fuse of the same amperage (same colour and markings) and size.

Fuse placement

No.	Consumer
1	Left light
2	Central locking, windscreen wipers, with Keyless Access
3	Ignition system relay
4	Right light
5	Electric windows - Driver
6	Central control unit - Interior lights

No.	Consumer
7	Horn
8	Towing bracket - Left light
9	Controls on steering column (without Keyless Access only), engine control unit (without Keyless Access only), automatic gearbox control unit (without Keyless Access only), automatic gearbox lever (without Keyless Access only), ESP control unit (without Keyless Access only), trailer hook control unit (without Keyless Access only), electric power steering (without Keyless Access only)
10	Rear left window
11	Headlight washer unit
12	Radio and navigation display
13	Preparation as taxi
14	Control lever under steering wheel, light switch, traction locking with ignition key (automatic transmission), headlight flasher, SmartGate control device, rain/light sensor, rear camera
15	Air conditioning system control unit, automatic gearbox selector lever, diagnostics connection
16	Instrument panel
17	Alarm sensor, horn
22	Windscreen washer system (without Keyless Access)
23	Heated front seats

No.	Consumer
24	Air conditioning fan, heating, control unit for air conditioning, heating
26	Front seat heating switch.
27	Rear window wiper
29	Airbag
30	Electric windows, reversing light switch, air conditioning control unit, Park Assist control unit, exterior mirror, power supply for middle button bar, power supply for the side button bar, interior mirror
31	Fuel pump, radiator fan control unit, cruise control, relay coil for the windscreen and rear window washer system, switch for the lights
32	Diagnostics socket, headlight range regulator, control lever under the steering wheel, ambient lighting regulator
33	Ignition relay coil, clutch pedal switch
34	Heatable washer jets of windscreen washer
36	USB charging socket
37	Radar
39	Additional electric heating
41	Rear window heater
42	Electric windows - passenger
43	Towing bracket - Connector contact

No.	Consumer
44	12 V connection in the interior, 12 V connection in the boot
45	Rear right window
46	Windshield and front window washing system, control lever under the steering wheel
47	Towing bracket - Connector contact
48	Towing bracket - Right hand light
49	Fuel pump control unit
50	Radio
51	Heat for exterior mirrors
52	Keyless Access
53	Steering lock (Keyless Access)
54	ABS/ESC control unit
56	Diagnosis
59	Full LED

Fuses in the engine compartment

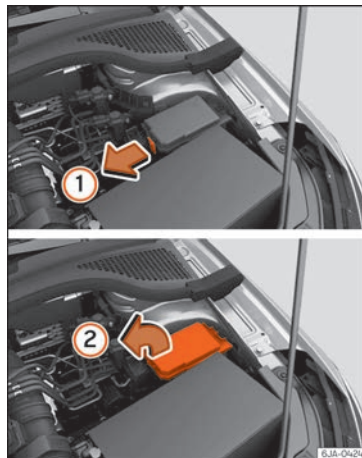

Fig. 87 In the engine compartment: lid of the fuse box - Variant 1

»



Fig. 88 In the engine compartment: lid of the fuse box - Variant 2

Read the additional information carefully
» page 45

Only replace fuses with a fuse of the same amperage (same colour and markings) and size.

Opening the fuse box

- Open the bonnet »» page 244.
- Press lid locking clip upwards in the direction of the arrow **1** »» Fig. 87 or »» Fig. 88.

- Open the cover in the direction indicated by the arrow **2**.
- Remove the plastic clip from the lid of the fuse box.
- Replace the appropriate fuse.
- Place the plastic clip back in its original position.
- Place the lid on the fuse box and press until you hear it click into place.

Fuse placement

No.	Consumer
1	Radiator fan
2	Control unit for the glow system
3	ABS/ESC control unit
4	Additional electric heat - Circuit 2
5	Additional electric heat - Circuit 3
6	Automatic gearbox
7	Engine control unit
8	Front windscreen wipers
9	Central control unit, battery data module
10	ABS/ESC control unit
12	Engine components
13	Brake pedal switch

No.	Consumer
14	Engine components, fuel coil relay, radiator fan, coolant pump
15	Engine control unit
16	Starter motor
17	Engine control unit
18	Engine components, additional electric heat relay coils
19	Lambda probe
20	Control devices for the glow system, heating of the sump fan

Changing bulbs

Introduction

Read the additional information carefully
» page 46.

Depending on how equipped the vehicle is, there are different sets of headlights and tail lights:

- Halogen main headlights (double headlight).
- Full-LED main headlights*.
- Rear bulb light.
- LED rear light*.

Full-LED headlight system*

Full-LED headlights handle all light functions (daylight, side light, turn signal, dipped beam and route light) with light emitting diodes (LEDs) as a light source.

Full-LED headlights are designed to last the lifetime of the car and light bulbs cannot be replaced. In case of headlight failure, go to an authorised workshop to have it replaced.

Double headlight bulb change

Changing bulbs requires a certain degree of practical skill. If in doubt, we recommend you have defective bulbs changed by a specialised service or, in case of an emergency, seek professional assistance.

- Switch off the ignition and all of the lights before changing a bulb.
- Do not touch the glass part of the bulb with your bare hands. The fingerprints left on the glass will vaporise as a result of the heat generated by the bulb, reducing bulb life and causing condensation on the reflector surface, thus reducing effectiveness.
- A bulb must only be replaced by one of the same type. The type is indicated on the bulb, either on the glass part or on the base.
- There is a storage area for the bulb box in the spare wheel well or below the carpet in the luggage compartment.

⚠ WARNING

- Take particular care when working on components in the engine compartment if the engine is warm. Risk of burns.
- Bulbs are highly sensitive to pressure. The glass can break when you touch the bulb, causing injury.
- When changing bulbs, please take care not to injure yourself on sharp parts in the headlight housing.

ⓘ CAUTION

- Remove the ignition key before working on the electric system. Otherwise, a short circuit could occur.
- Switch off the lights and the parking light before changing a bulb.

♻ For the sake of the environment

Please ask your specialist retailer how to dispose of used bulbs in the proper manner.

ⓘ Note

- Depending on weather conditions (cold or wet), the front lights, the fog lights, the rear lights and the turn signals may be temporarily misted. This has no influence on the useful life of the lighting system. By switching on the lights, the area through which the beam of light is projected will

quickly be demisted. However, the edges may continue to be misted.

- Please check at regular intervals that all lighting (especially the exterior lighting) on your vehicle is functioning properly. This is not only in the interest of your own safety, but also that of all other road users.
- Before changing a bulb, make sure you have the correct new bulb.
- Do not touch the glass part of the bulb with your bare hands, use a cloth or paper towel instead. Otherwise, the fingerprints left on the glass will vaporise as a result of the heat generated by the bulb, they will be deposited on the reflector and damage its surface.

Double headlight bulbs

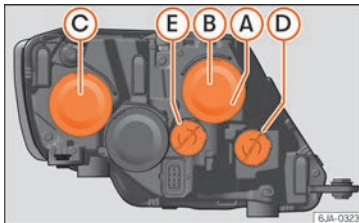

Fig. 89 Main headlight bulbs.

Installation position of double headlight bulbs »

- A** Side lights
- B** Main beam headlights
- C** Dipped beam headlights
- D** Turn signal lights
- E** Daylight

Changing side light bulbs

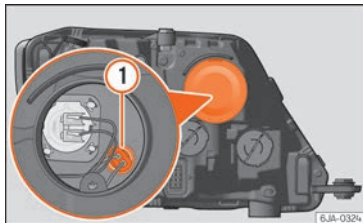

Fig. 90 Changing side light bulbs.

- Raise the bonnet.
- Remove the protective cover »» **Fig. 90**.
- Remove the bulb holder »» **Fig. 90 1** by pulling it outwards.
- Remove the bulb by pulling it out and fit the new one.
- Installation involves all of the above steps in reverse sequence.

- Fit the protective cover. Make sure that the cover fits correctly on the housing during operation.
- Check whether the new bulb is working.

Changing main beam headlight bulb

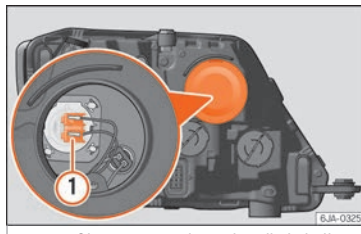

Fig. 91 Changing main beam headlight bulbs.

- Raise the bonnet.
- Remove the protective cover.
- Remove connector »» **Fig. 91 1** by pulling outward.
- Extract the bulb and fit the replacement so that it fits correctly into the recess on the reflector.
- Installation involves all of the above steps in reverse sequence.

- Fit the protective cover. Make sure that the cover fits correctly on the housing during operation.
- Check whether the new bulb is working.

Changing dipped beam light bulbs



Fig. 92 Changing dipped beam headlight bulbs:

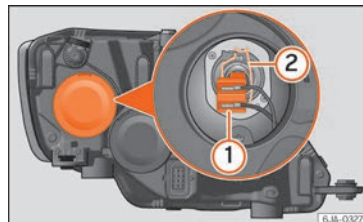

Fig. 93 Changing dipped beam headlight bulbs.arch trim.

- Turn the wheel for access to the wheel housing cover and remove the cover »» Fig. 92.
- Remove the protective cover from the headlight »» Fig. 93.
- Remove connector »» Fig. 93 ① by pulling outward.
- Unclip the retainer spring »» Fig. 93 ② pressing clockwise and inwards.
- Extract the bulb and fit the replacement so that the lug on the base fits into the recess on the reflector.
- Fit the connector.
- Fit the protective cover. Make sure that the cover fits correctly on the housing during operation.
- Replace the wheel housing cover.
- Check whether the new bulb is working.

Changing turn signal bulbs

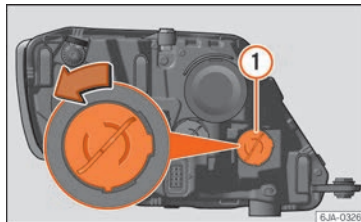

Fig. 94 Changing turn signal bulbs.

- Raise the bonnet.
- Turn the bulb holder »» Fig. 94 ① anti-clockwise and remove it.
- Remove the bulb by pressing on the bulb holder and turning it anti-clockwise at the same time.
- Fit the replacement bulb in the bulb holder and turn clockwise as far as it will go.
- Check whether the new bulb is working.

Changing daytime driving light bulbs

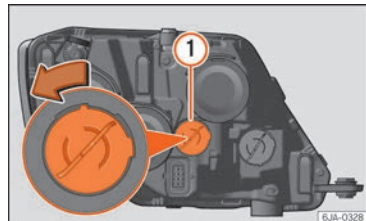

Fig. 95 Changing daytime driving light bulbs.

- Raise the bonnet.
- Turn the bulb holder »» Fig. 95 ① anti-clockwise and remove it.
- Remove the bulb by pressing on the bulb holder and turning it anti-clockwise at the same time.
- Fit the replacement bulb in the bulb holder and turn clockwise as far as it will go.
- Check whether the new bulb is working.

Changing the fog light bulbs

Front fog light bulb

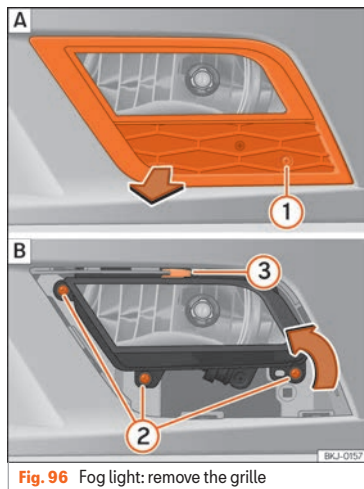

Fig. 96 Fog light: remove the grille

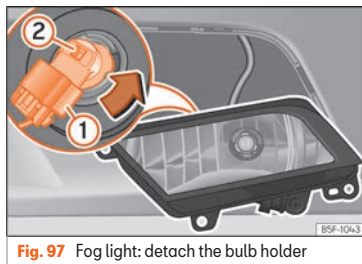

Fig. 97 Fog light: detach the bulb holder

- Remove the bolt »» Fig. 96 ① from the fog light grille with a screwdriver.
- Subsequently, remove the clips located on the edge of the grill with gentle leverage.
- Remove the 3 bolts ②.
- Remove the metal clip situated on the upper part of the fog light by pulling away from the vehicle ③ and extract the fog light.
- Remove connector »» Fig. 97 ① from the bulb.
- Turn the bulb holder »» Fig. 97 ② to the left and pull.

- Remove the bulb by pressing on the bulb holder and turning it counter-clockwise at the same time.
- Installation involves all of the above steps in reverse sequence.
- Check that the bulb works properly.

Changing the rear lights (on the side panel)

Removing the rear light¹⁾

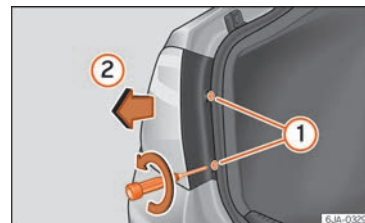

Fig. 98 Remove the rear light unit from side panel.

¹⁾ In the case of LED rear lights of the side panel only the turn signal lamp can be changed. The illustrations in the manual correspond to the bulb version and do not correspond exactly to the LED version.

Check which of the bulbs is defective.

- Open the luggage compartment to access the raïnduct area.
- Take the screwdriver or a Torx 20 key (T20) from the vehicle tool kit and loosen (turning anti-clockwise) and remove the two retaining screws that secure the front of the light »» Fig. 98 ①, taking care not to lose them.
- Pull the rear light unit backward (»» Fig. 98 ②) to remove the light from its housing.

Removing the bulb holder

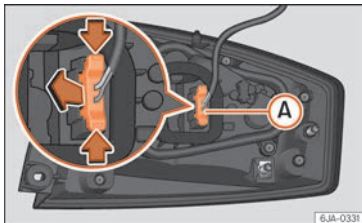

Fig. 99 Light connector at the rear of the rear light unit.

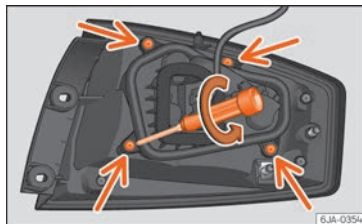

Fig. 100 Retaining screws on reverse side of rear light unit.

- Disconnect the light connector (A) »» Fig. 99 by moving its side levers (arrows) and pulling the connector outwards.
- Place the light on a level, horizontal surface on top of a soft cloth so as not to scratch the outer glass.
- Unscrew the four retaining screws from the bulb holder anti-clockwise using a screwdriver or a Torx 20 key (T20) from the vehicle tool kit »» Fig. 100. Take care not to lose the bulb holder retaining screws.

Changing bulbs

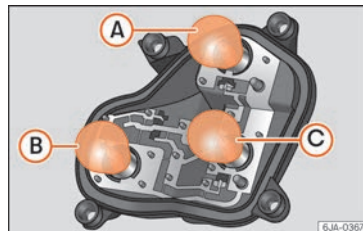

Fig. 101 Position of the bulbs in the bulb holder

The bulbs are secured with a bayonet fastener. The table below gives an overview of the bulb positions.

- Lightly press the defective bulb into the bulb holder, then turn it anti-clockwise and remove it.
- Fit the new bulb, pressing it into the bulb holder and turn it clockwise as far as it will go.
- Use a cloth to remove any fingerprints from the glass part of the bulb.
- Check that the new bulb works properly.
- Replace the bulb holder.
- Screw in the bulb holder using the four screws, turning them clockwise.

»

Position of the bulbs

»» Fig. 101	Bulb function
A	Turn signals: PY21W NA LL
B	Side lights-brake lights: P21/5W
C	Position: P21/5W

i Note

Check the condition of the seal. If damaged, a replacement can be acquired from an Official Service.

Fitting the rear light

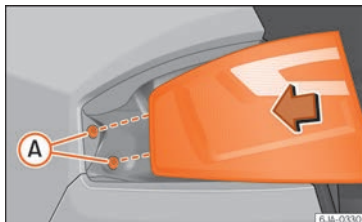

Fig. 102 Fit the tail light unit.

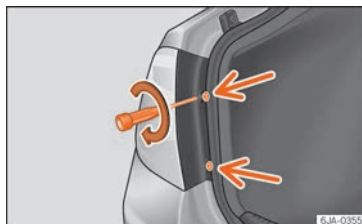

Fig. 103 Fit the tail light unit.

- Make sure the connector is correctly in place.
- Press the rear light unit backwards (driving direction) by fitting the fastenings into the rubber mountings »» Fig. 102 A.
- Take the screwdriver or a Torx 20 key (T20) from the vehicle tool kit and tighten (turning clockwise »» Fig. 103) the two retaining screws that secure the front of the light.

Changing tail lights (on the rear lid)

Removing the bulb holder¹⁾

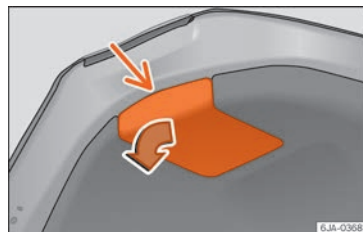

Fig. 104 Remove the cover from the rear lid.

¹⁾ For rear-lid LED rear lights, only the reverse and retro fog bulb can be replaced. The illustrations in the manual correspond to the bulb version and do not correspond exactly to the LED version.

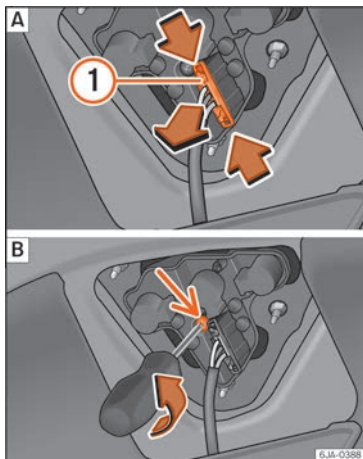

Fig. 105 Remove the bulb holder.

The rear lid must be open to change the bulbs.

You can access the bulb holder for the inner tail lights through the inside of the rear lid.

- Check which of the bulbs is defective.
- Open the cover to access the lights, turning it by hand in the direction indicated by the arrows.
- Access the lights by disconnecting the connector ① »» Fig. 105 [A] and unscrewing

the bulb holder »» Fig. 105 [B]. Take care not to lose the bulb holder retaining screw.

- Change the bulbs »» page 93.

Changing bulbs

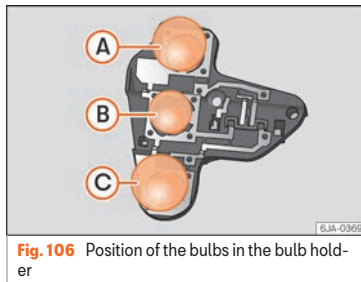

Fig. 106 Position of the bulbs in the bulb holder

The bulbs are secured with a bayonet fastener. The table below gives an overview of the bulbs »» table on page 93.

- Lightly press the defective bulb into the bulb holder, then turn it anti-clockwise and remove it.
- Fit the new bulb, pressing it into the bulb holder and turn it clockwise as far as it will go.
- Use a cloth to remove any fingerprints from the glass part of the bulb.

- Check that the new bulb works properly.
- Re-install the bulb holder »» page 93.
- Screw in the bulb holder.

Position of the bulbs

»» Fig. 106	Bulb function
Ⓐ	Reversing lights: P21W
Ⓑ	Side lights: R5W LL
Ⓒ	Fog lights: P21W

i Note

One of the two sides may not be fitted with a fog light, depending on the country and type of driving. In this case, the hole for the light is covered.

Fitting the bulb-holder

- Position the bulb holder on the tail light and align it so that it is securely seated.
- Screw in the bulb holder using the corresponding screw.
- Make sure the connector is correctly in place.
- Close the inner trim cover. »»

Note

Check the condition of the seal. If damaged, a replacement can be acquired from an Official Service.

Changing the side and number plate bulbs

Side turn signals

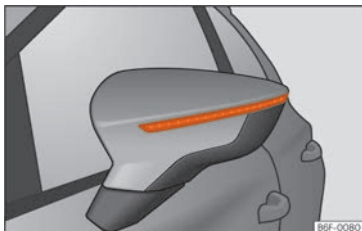

Fig. 107 Turn signal integrated in the rear view mirror

The side turn signals are LEDs and are integrated in the exterior mirrors.

In case of failure, go to an authorised workshop to have them replaced.

Changing the bulb on the number plate



Fig. 108 Removing number plate light

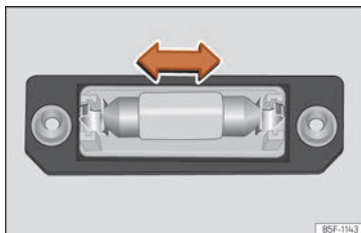

Fig. 109 Changing the bulb.

Removing the bulb holder

- Unscrew the screws to remove the bulb »» Fig. 108.
- Remove the bulb, moving it in the direction of the arrow and outwards »» Fig. 109.

Note

Depending on how equipped the vehicle is, the number plate lights may be LEDs. LEDs have an estimated life that exceeds that of the car. If a light with LEDs fails, go to an authorised workshop for replacement.

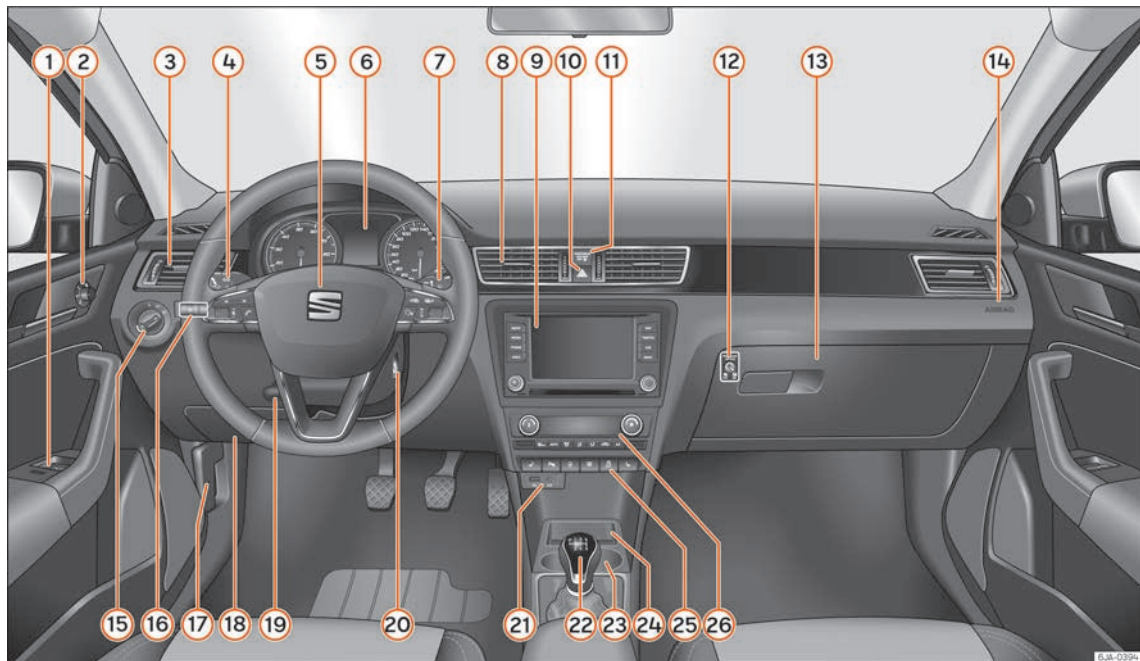

Fig. 110 Interior.

6.18-0394

Operation

Controls and displays

General instrument panel

① Electric window controls	119	– Navigation system		– Driver heated seat	132
② Control for adjusting electric exterior mirrors	130	⑩ Hazard warning lights switch	125	– Park assist system	222
③ Air vents	147	⑪ Control lamp for deactivated front passenger airbag in centre console	73	– Central lock button	113
④ Multifunction switch lever:		⑫ Front passenger airbag switch	73	– Heated rear window	127
– Turn signals, headlights, parking lights, headlight flasher	122	⑬ Depending on the equipment, glove compartment with:	135	– Start-Stop system	215
– Cruise control	217	– CD player* and/or SD card*	175	– Front passenger heated seat	132
⑤ Steering wheel:		⑭ Front passenger airbag	16	⑯ Depending on the equipment:	
– With horn		⑮ Headlight switch	121	– Heating controls	148
– With the driver front airbag	16	⑯ Headlight range control	121	– Air conditioning controls	149
– With controls for audio, navigation system and telephone	103	⑰ Lever for unlocking the bonnet	13	– Climatronic control	151
⑥ General instrument panel: Instruments and warning lamps	97	⑱ Fuse compartment	84		
⑦ Multifunction switch lever:		⑲ Steering column adjustment lever	16		
– Multifunction display	27	⑳ Ignition lock	197		
– Windscreen wipers and windscreen washers	129	㉑ USB/AUX-IN input	195		
⑧ Air vents	147	㉒ Depending on the equipment:			
⑨ Depending on the equipment:		– Gear lever (manual gearbox)	203		
– Audio system		– Selector lever (automatic gearbox)	205		
		⑳ Depending on the equipment:			
		– Drink holder	137		
		– Ashtray holder	138		
		㉔ Storage space	135		
		㉕ Depending on the equipment, controls for:			

Note

The location of the controls of right-hand drive cars differs slightly from the location shown here »» Fig. 110. However, the symbols correspond to the respective controls.

Instruments and warning lamps

Instruments

View of instrument panel

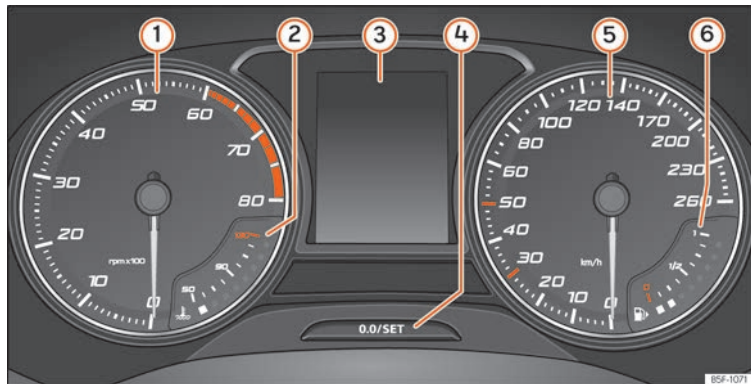

Fig. 111 Instrument panel, on dash panel.

Details of the instruments » **Fig. 111:**

- ① **Revolution counter** (with the engine running, in hundreds of revolutions per minute).

The beginning of the red zone of the rev counter indicates the maximum speed in any gear after running-in and with the engine hot. However, it is advisable to

change up a gear or move the selector lever to D (or lift your foot off the accelerator) before the needle reaches the red zone » ①.

- ② **Engine coolant temperature display** » page 247
- ③ **Displays on the screen.**

- ④ **Adjuster button and display** » page 101.
- ⑤ **Speedometer.**
- ⑥ **Fuel gauge** » page 102.

⚠ WARNING

Any distraction may lead to an accident, with the risk of injury.

- Do not operate the instrument panel controls when driving.

① CAUTION

- To prevent damage to the engine, the rev counter needle should only remain in the red zone for a short period of time.
- When the engine is cold, avoid high revs and heavy acceleration and do not make the engine work hard.

🌿 For the sake of the environment

Changing up a gear in time reduces fuel consumption and noise.

Revolution counter

The rev counter indicates the number of engine revolutions per minute » Fig. 111 ①.

Together with the gear-change indicator, the rev counter offers you the possibility of using the engine of your vehicle at a suitable speed.

The start of the red zone on the dial indicates the maximum engine speed which may be used briefly when the engine is warm and after it has been run in properly. Before reaching this range, you should change to a higher gear for vehicles with a manual gearbox or for automatic gearboxes put the selector lev-

er in "D" or take your foot off the accelerator pedal.

We recommend that you avoid high revs and that you follow the recommendations on the gear-change indicator. Consult the additional information in » page 208.

① CAUTION

Never allow the rev counter needle ① » Fig. 111 to go into the red zone on the scale for more than a very brief period, otherwise there is a risk of engine damage.

🌿 For the sake of the environment

Changing up a gear early will help you to save fuel and minimise emissions and engine noise.

Indications on the display

A variety of information can be viewed on the instrument panel display » Fig. 111 ③ depending on the vehicle equipment:

- Bonnet, rear lid and doors open » Fig. 111 ③
- Information and warning texts.
- Mileage.
- Time.
- Navigation instructions.

- Outside temperature.
- Compass.
- Shift lever position » page 205.
- Recommended gear (manual gearbox) » page 208.
- Multifunction display (MFD) and menus with different setting options » Fig. 111 page 27.
- Service interval display » Fig. 111 page 33.
- Second speed display » page 100.
- Speed warning function » Fig. 111 page 32.
- Start-Stop system status display » page 215.
- Low consumption driving status » page 100
- Identifying letters on engine (LDM) » page 100.

Distance travelled

The odometer registers the total distance travelled by the car.

The odometer (trip) shows the distance travelled since the last odometer reset. The last digit of the trip recorder indicates distances of 100 metres or one tenths of a mile.

- Briefly press the button » Fig. 111 ④ to reset the trip recorder to 0.
- Keep the button ④ pressed for about 3 seconds and the previous value will be displayed.

⚠ WARNING

Observe the safety warnings »» ⚠ in Control and warning lamps on page 103.

⚠ WARNING

Even though outside temperatures are above freezing, some roads and bridges may be icy.

- At outside temperatures above +4°C (+39°F), even when the "ice crystal symbol" is not visible, there may still be patches of ice on the road.
- The outside temperature sensor takes a guideline measurement.

i Note

- Different versions of the instrument panel are available and therefore the versions and instructions on the display may vary. In the case of displays without warning or information texts, faults are indicated exclusively by the warning lamps.
- Depending on the equipment, some settings and instructions can also be carried out in the Easy Connect system.
- When several warnings are active at the same time, the symbols are shown successively for a few seconds and will stay on until the fault is rectified.

Odometer

Fig. 112 Instrument panel: odometer and reset button.

The distance covered is displayed in "kilometres" or miles "m". It is possible to change the measurement units (kilometres "km"/miles "m") in the radio/Easy Connect* »» 🗨 page 24.

Odometer/trip recorder

The odometer shows the total distance covered by the vehicle.

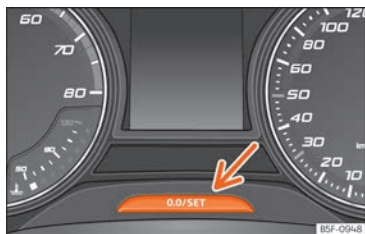
The trip recorder shows the distance that has been travelled since it was last reset. It is used to measure short trips. The last digit of the trip recorder indicates distances of 100 metres or tenths of a mile.

The trip recorder can be set to zero by pressing **0.0/SET** »» **Fig. 112**.

Fault display

If there is a fault in the instrument panel, the letters **DEF** will appear in the trip recorder display. Have the fault repaired immediately, as far as is possible.

Coolant temperature gauge

Fig. 113 Instrument panel: coolant temperature gauge

For vehicles with no coolant temperature gauge, a control lamp 🚗 appears when the coolant temperatures is high »» page 248. Please note »» ⚠.

The coolant temperature gauge only works when the ignition is switched on »» **Fig. 113**. In order to avoid engine damage, please read the following notes for the different temperature ranges. »»

A – Cold zone

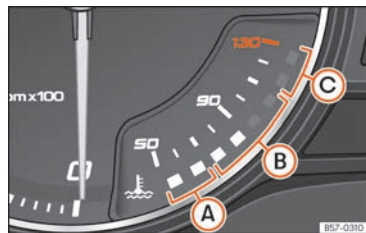
If only the diodes in the lower part of the scale light up, this indicates that the engine has not yet reached operating temperature. Avoid high revs and heavy acceleration and do not make the engine work hard.

B - Normal temperature

If in normal operations, the diodes light up until the central zone, it means that the engine has reached operating temperature. At high outside temperatures and when making the engine work hard, the diodes may continue lighting up and reach the upper zone. This is no cause for concern, provided the control lamp  does not light up on the instrument panel digital display.

C – Heat range

When the LEDs light up in the upper area of the display and the control lamp  appears on the instrument panel display, the coolant temperature is too high **>>> page 248.**

ⓘ CAUTION

• To ensure a long useful life for the engine, avoid high revs, driving at high speed and making the engine work hard for approximately the first 15 minutes when the engine is cold. The phase until the engine is warm also depends on the outside temperature. If necessary, use the engine oil temperature* **>>> page 247 as a guide.**

• Additional lights and other accessories in front of the air inlet reduce the cooling effect of the coolant. At high outside temperatures and high engine loads, there is a risk of the engine overheating.

• The front spoiler also ensures proper distribution of the cooling air when the vehicle is moving. If the spoiler is damaged this can reduce the cooling effect, which could cause the engine to overheat. Seek specialist assistance.

Fuel level gauge

Fig. 114 Fuel gauge.

Control lamp

It lights up, and in addition, the lower diode lights up in red

The fuel reserve level has been reached. When the fuel level is very low, the lower diode flashes in red.

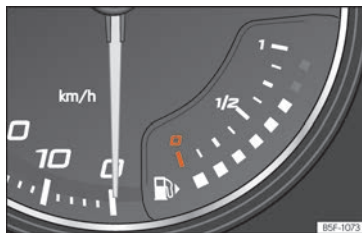
The fuel gauge **>>> Fig. 114** operates only when the ignition is switched on.

The fuel tank has a capacity of approx. 55 litres. When the needle reaches the fuel reserve area there are only approximately 7 litres left in the tank. In the general instrument panel a warning signal lights up  and an audible signal sounds.

The informative display indicates:

Refuel! Fuel range...km...(miles)

ⓘ CAUTION

Never completely empty the tank! An irregularity in the fuel supply system can cause irregularities when the engine is running. Unburned fuel can reach the exhaust gas system, which can cause deterioration of the catalytic converter.

ⓘ Note



• Some vehicles come fitted with the fuel gauge on the general instrument panel.

- The message on the display switches off only after refuelling and carrying out a short journey.

Control lamps

Control and warning lamps

Read the additional information carefully »»  page 34.

The control and warning lamps are indicators of warnings, »» , faults »»  or certain functions. Some control and warning lamps come on when the ignition is switched on, and switch off when the engine starts running, or while driving.

Depending on the model, additional text messages may be viewed on the instrument panel display. These may be purely informative or they may be advising of the need for action »» page 98.

Depending upon the equipment fitted in the vehicle, instead of a warning lamp, sometimes a symbol may be displayed on the instrument panel.

When certain control and warning lamps are lit, an audible warning is also heard.

WARNING

If the warning lamps and messages are ignored, the vehicle may stall in traffic, or may cause accidents and severe injuries.

- Never ignore the warning lamps or text messages.
- Stop the vehicle safely as soon as possible.
- Park the vehicle away from traffic and ensure that there are no highly flammable materials under the vehicle that could come into contact with the exhaust system (e.g. dry grass, fuel).
- A faulty vehicle represents a risk of accident for the driver and for other road users. If necessary, switch on the hazard warning lamps and put out the warning triangle to advise other drivers.
- Before opening the bonnet, switch off the engine and allow it to cool.
- In any vehicle, the engine compartment is a hazardous area and could cause severe injuries »» page 244.

CAUTION

Failure to heed the control lamps and text messages when they appear may result in faults in the vehicle.

Multi-function steering wheel*

General information

The steering wheel includes a multifunction module from where it is possible to control the audio, telephone and radio/navigation functions without needing to distract the driver.

There are two versions of the multifunction module:

- **Voice-controlled audio, phone and navigation version:** for controlling the audio functions available (radio, audio CD, MP3, iPod^{®1)}, USB¹⁾, SD¹⁾) and Bluetooth system from the steering wheel.
- **Voice-controlled audio, phone and navigation version:** for controlling the audio functions available (radio, audio CD, MP3, iPod^{®1)}, USB¹⁾, SD¹⁾) and Bluetooth system from the steering wheel.

¹⁾ Depending on the vehicle equipment.

Operating the audio, telephone and navigation system with voice control

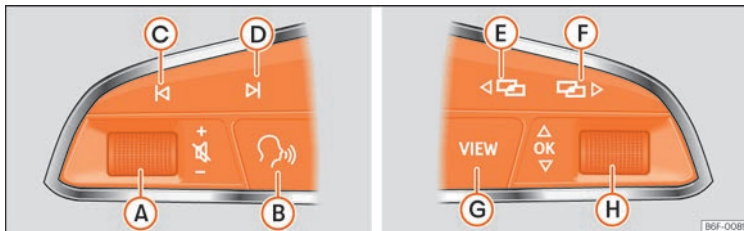





Fig. 115 Controls on the steering wheel.

Button	Radio	Media (except AUX)	AUX	Telephone ^{a)}	Navigation ^{a)}
A Turn	Turn volume up/down. You do not need to be in audio mode (radio).	Turn volume up/down. You do not need to be in audio mode (media).	Turn volume up/down. You do not need to be in audio mode (media).	Turn volume up/down. You do not need to be in telephone mode.	Turn announcement volume up/down. You do not need to be in navigation mode but there has to be an announcement active when you adjust the volume.
A Press	Mute volume.	Mute volume.	Mute volume.	Mute incoming call.	Mute the current navigation announcement.
B ^{a)}	Activate/deactivate voice control. This function can be used from any mode (audio, media, navigation, assistants, vehicle status, travel data). When the system is in telephone mode this button's function is deactivated during the ongoing call, and without Radio/Media functionality (except AUX).				
C / D	Search for the previous/next station ^{b)} .	Short press: Switch to the previous/next song. Hold down: Fast rewind/forward ^{c)} .	No function	- There is no active call: Radio/Media functionality (except AUX) - Active call: no function	No function for the other modes (navigation, assistants, vehicle status, travel data).
E / F ^{a)}	Change instrument panel menu. This function can be used from any mode (audio, media, navigation, assistants, vehicle status, travel data).				

Instruments and warning lamps

Button	Radio	Media (except AUX)	AUX	Telephone ^{a)}	Navigation ^{a)}
	<i>Coloured instrument panel:</i> change to the previous menu. <i>Monochrome Instrument panel:</i> switch to the previous function.				
 Turn	<i>Coloured instrument panel:</i> List of stations available (only if the instrument panel is in audio menu).	<i>Coloured instrument panel:</i> next track (only if the instrument panel is in audio menu).	No function	– <i>There is no active call:</i> List of last calls. – <i>Active call:</i> access the call options list (call on hold, hang up, mute microphone, private number, etc.).	– <i>Active route:</i> access the view to halt guidance to destination. – <i>No active route:</i> list of previous destinations.
 Press	Acts on the instrument panel or confirms the instrument panel menu option depending on the menu option.				

^{a)} According to the vehicle's equipment package.

^{b)} This action can be performed when you are listening to the radio; there is no need to be in audio-radio mode.

^{c)} These actions can be performed when you are listening to media; there is no need to be in audio-radio mode.

Operating the audio, telephone and navigation system with voice control

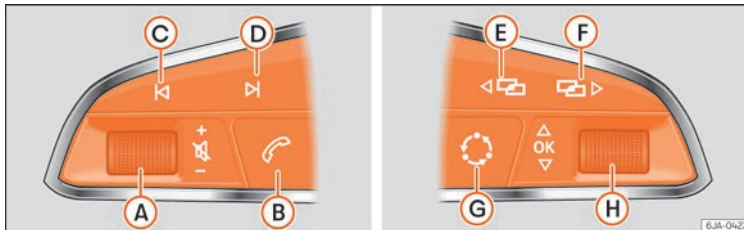





Fig.116 Controls on the steering wheel.

Button	Radio	Media (except AUX)	AUX	Telephone ^{a)}	Navigation ^{a)}
A Turn	Turn volume up/down. You do not need to be in audio mode (radio).	Turn volume up/down. You do not need to be in audio mode (media).	Turn volume up/down. You do not need to be in audio mode (media).	Turn volume up/down. You do not need to be in telephone mode.	Turn announcement volume up/down. You do not need to be in navigation mode but there has to be an announcement active when you adjust the volume.
A Press	Mute volume.	Mute volume.	Mute volume.	Mute incoming call.	Mute the current navigation announcement.
B ^{a)}	- Incoming call: pick up (short press), reject (long press). - Ongoing call: hang up (short press). - No incoming/ongoing call: open phone menu (short press), repeat last ongoing call (long press). These functions can be carried out on any mode (audio, media, navigations, assistants, vehicle status, travel data).				
C / D	Search for the previous/next station ^{b)} .	Short press: Switch to the previous/next song. Hold down: Fast rewind/forward ^{c)} .	No function	- There is no active call: Radio/Media functionality (except AUX) - Active call: no function	No function for the other modes (navigation, assistants, vehicle status, travel data).
E / F ^{a)}	Change instrument panel menu. This function can be used from any mode (audio, media, navigation, assistants, vehicle status, travel data).				

Instruments and warning lamps

Button	Radio	Media (except AUX)	AUX	Telephone ^{a)}	Navigation ^{a)}
	Cycles through the audio source: FM/AM – CD – SD - USB - AUX - BT Audio (only those that are available). This function can be used from any mode (audio, media, navigation, assistants, vehicle status, travel data).				
 Turn	Coloured instrument panel: List of stations available (only if the instrument panel is in audio menu).	Coloured instrument panel: next track (only if the instrument panel is in audio menu).	No function	<ul style="list-style-type: none"> - <i>There is no active call</i>: List of last calls. - <i>Active call</i>: access the call options list (call on hold, hang up, mute microphone, private number, etc.). 	<ul style="list-style-type: none"> - <i>Active route</i>: access the view to halt guidance to destination. - <i>No active route</i>: list of previous destinations.
 Press	Acts on the instrument panel or confirms the instrument panel menu option depending on the menu option.				

^{a)} According to the vehicle's equipment package.

^{b)} This action can be performed when you are listening to the radio; there is no need to be in audio-radio mode.

^{c)} These actions can be performed when you are listening to media; there is no need to be in audio-radio mode.

Opening and closing

Remote control

General notes

Read the additional information carefully
»  page 11

The remote control key can

- Lock and unlock the vehicle
- Unlock or open the rear lid.

The remote control transmitter and the batteries are integrated in the key. The receiver is inside the vehicle. The remote control key has a maximum range of 30 metres. The range is reduced as the batteries start to lose power.

The key includes a foldaway part that can be used to manually lock or unlock the vehicle and to start the engine.

If a lost key is replaced or the receiver is repaired or changed, the remote control key must be adapted by an authorised SEAT dealer. Only then can the remote control key be used again.

Note

- The remote control is automatically deactivated when the ignition is switched on.

- The remote control function may be temporarily limited by interference from other transmitters near the vehicle that operate on the same frequency (e.g. mobile phone, television transmitter).

- If the central locking system or the anti-theft alarm only responds to the remote control at a distance of less than 3 metres, then the battery must be replaced
» page 110.

- If the driver door is open, the vehicle cannot be locked using the remote control.

Unlocking and locking the vehicle

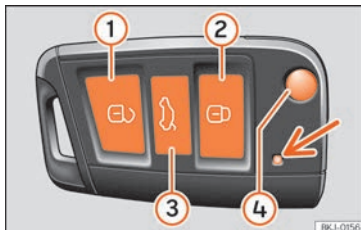

Fig. 117 Remote control key

Unlocking the vehicle

- Press button **1**.

Locking the vehicle

- Press button **2**.

Deactivating the Safe lock

- Press button **2** twice in 2 seconds. Further information » page 110.

Unlocking the rear lid

- Press button **3**. Further information » page 117.

Unfolding the key shaft

- Press button **4**.

Folding the key shaft

- Press button **4** and fold the key shaft back to its original position.

The turn signals will flash twice when the vehicle is unlocked. If the vehicle is unlocked using button **1** and none of the doors or the rear lid is opened in the following 30 seconds, the vehicle will automatically relock and the Safe lock or the anti-theft alarm will be activated. This function prevents the vehicle from being unlocked by mistake.

Locking indication



The turn signals will flash if the vehicle has been correctly locked.

Should any of the doors or the rear lid remain open when the vehicle is locked, the turn signals will only flash when they are closed.

⚠ WARNING

Do not leave people or animals in vehicles locked from outside with the Safe lock activated: the doors and windows cannot then be opened from the inside. Doors locked in this manner could delay assistance in an emergency. Risk of death!

i Note

- Only use the remote control when the doors and the rear lid are locked and the vehicle is within sight.
- Do not press the lock button  on the remote control before inserting the key in the ignition, otherwise the vehicle could be locked by mistake. Should this occur, press the unlock button  on the remote control.

Remote control synchronisation

If the vehicle cannot be locked or unlocked using the remote control, the key code may not match that of the control unit. This can occur when the remote control buttons are frequently pressed outside the range of the system or if the remote control battery has been replaced.

In this case, it must be synchronised as follows:

- Press any key on the remote control key.
- Open the door using the key within the next minute.

Keys

General notes

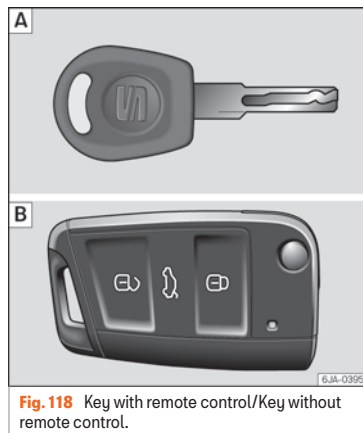

Fig. 118 Key with remote control/Key without remote control.

Two keys are always supplied with the vehicle. Depending on the model version, your

car may include keys without remote control >>> Fig. 118 A or with remote control >>> Fig. 118 B.

⚠ WARNING

- Never leave the key inside whenever you leave the vehicle - even if only for a moment. This is particularly important if children are to remain in the vehicle. Children might start the engine or some other electrical component, e.g. electric windows. Risk of injury!
- Wait until the vehicle has completely stopped before taking the key out of the ignition. Otherwise the steering wheel may lock suddenly. Risk of accident!

ⓘ CAUTION

- Each key contains electronic components and must, therefore, be protected from dampness and strong vibrations.
- Keep the grooves in the key shaft clean. Any dirt (fibre from clothing, dust, etc.) has a negative impact on locks, ignition, etc.

i Note

Should a key be lost, request a duplicate key from an Authorised SEAT dealer.

Replacing the battery in the remote control key

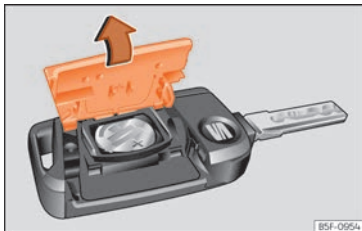

Fig. 119 Vehicle key: opening the battery compartment.

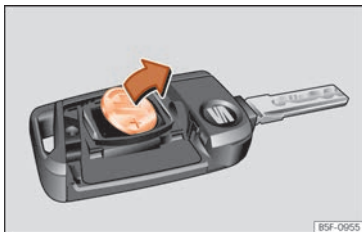

Fig. 120 Vehicle key: removing the battery.

SEAT recommends you ask a specialised workshop to replace the battery.

The battery is located to the rear of the vehicle key, under a cover.

Changing the battery

- Unfold the vehicle key shaft.
- Remove the cover from the back of the vehicle key »» Fig. 119 in the direction of the arrow »» ⚠.
- Extract the battery from the compartment using a suitable thin object »» Fig. 120.
- Place the new battery in the compartment as shown »» Fig. 120, pressing in the opposite direction to that shown by the arrow »» ⚠.
- Fit the cover as shown »» Fig. 119, pressing it onto the vehicle key casing in the opposite direction to that shown by the arrow until it clicks into place.

⚠ CAUTION

- If the battery is not changed correctly, the vehicle key may be damaged.
- Use of unsuitable batteries may damage the vehicle key. For this reason, always replace the dead battery with another of the same voltage, size and specifications.
- When fitting the battery, check that the polarity is correct.

♻ For the sake of the environment

Please dispose of your used batteries correctly and with respect for the environment.

ℹ Note

If it is not possible to unlock or lock the vehicle with the remote control key once the battery has been replaced, it will need to be re-synchronised »» page 109.

Central locking system

General notes

All of the doors, the rear lid and the fuel cap flap¹⁾ will unlock at the same time when the central locking system is used.

Warning lamp on the driver door

Once the doors are locked, the warning lamp will flash quickly for 2 seconds and then at a slower rate.

If the vehicle is locked with Safe lock engaged »» page 112, the warning lamp on the

¹⁾ Valid for vehicles with a keyless fuel tank cap.

driver door will flash quickly for 2 seconds before switching off for 30 seconds and then flashing at a slower rate.

If the warning lamp flashes quickly for 2 seconds and then remains switched on before flashing at a slower rate after 30 seconds, there is a fault in the interior monitor and tow-away protection system »» page 117. Go to a technical service.

⚠ WARNING

- Locking from the outside carelessly or without good visibility may lead to bruising, particularly in the case of children.
- When locking a vehicle, never leave children unaccompanied inside, as from the outside it will be difficult to provide assistance if required.
- Having the doors locked prevents intruders from getting in, for example when stopped at a traffic light.

Individualised settings

Unlocking single doors

This optional function unlocks the driver door only. The other doors remain locked and are only unlocked when the next command is given (unlock).

¹⁾ Valid for vehicles with a keyless fuel tank cap.

Automatic unlock and lock

The doors and the rear lid are locked automatically when the vehicle reaches a speed of about 15 km/h (9 mph).

The doors unlock automatically when the key is removed from the ignition. Additionally, the driver or front passenger can unlock the doors by pressing the  »» page 113 central lock button or by pulling the front door handle.

⚠ WARNING

Locking the doors prevents intruders from getting into the car, e.g. while waiting at intersections. However, it can also delay assistance in the event of an accident. Risk of death!

i Note

- Activation of the single door setting can be requested at your SEAT dealer.
- In the event of an accident in which the airbags deploy, the doors will be automatically unlocked for easier access and assistance.
- If the central locking system should fail to work at any time, only the driver door can be locked or unlocked using the key »» page 112. All other doors and the rear lid can be operated manually.

- Manual release »»  page 12.
- Manual release mechanism for the rear lid »»  page 12.

Unlocking with key

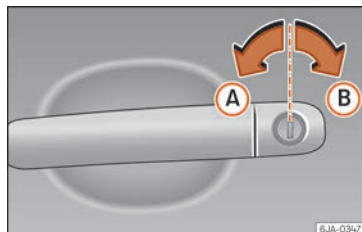

Fig. 121 Key positions during vehicle locking and unlocking.

- Turn the key in the driver door in the forward driving direction to its unlock position **A** »» **Fig. 121**.
- Pull the handle and open the door.
- All doors (driver door only on vehicles with anti-theft alarm) are unlocked.
- The rear lid is unlocked.
- The fuel tank flap is unlocked¹⁾.

»

- The courtesy lights switch on.
- The Safe lock is deactivated.
- The driver door warning lamp stops flashing (on vehicles not equipped with an anti-theft system) »» page 116.

Note

If the vehicle is equipped with an anti-theft alarm system, you have 15 seconds from the time the door is opened to insert the key in the ignition and start the vehicle. If, during these 15 seconds, the vehicle is not started, the alarm is triggered.

Locking with key

- Turn the key in the driver door lock cylinder in the reverse direction to its lock position  »» Fig. 121.
- The doors, the rear lid and the fuel tank flap¹⁾ will be locked.
- The courtesy lights switch off.
- The Safe lock is immediately activated.
- Warning lamp on the driver door starts to flash.

¹⁾ Valid for vehicles with a keyless fuel tank cap.

Note

The vehicle doors cannot be locked if the driver door is open.

Safe Lock

The central locking system is equipped with a **Safe lock**. If the vehicle is closed from outside, the door locks will automatically lock. The warning lamp on the driver door will flash quickly for about 2 seconds and then at a slower rate. It is not possible to open any of the doors from the inside or outside using the handle. This limits the possibility of intruders getting into the vehicle.

The Safe lock can be deactivated by pressing the lock button twice in less than 2 seconds.

If Safe lock is out of service, the control lamp on the driver door will flash quickly for about 2 seconds before switching off for 30 seconds and then flashing at a slower rate.

The Safe lock is re-activated on unlocking and locking the vehicle again.

If the vehicle is locked and the Safe lock is deactivated, the vehicle can be opened from inside by pulling on the door handle.

WARNING

Do not leave people or animals in locked vehicles with Safe lock activated: the doors and windows cannot then be opened from the inside. Doors locked in this manner could delay assistance in an emergency. Risk of death!

Note

- The anti-theft alarm switches on automatically when the vehicle is locked, even if the Safe lock is deactivated. The Vehicle interior monitoring, however, is not activated.
- Given that the Safe function will be activated on locking the vehicle, CHECK DEAD-LOCK will be shown on the general instrument panel display. On vehicles equipped with an informative display, Caution SAFE! On-board documentation!

Central locking button



Fig. 122 Central lock button.

If the vehicle has not been locked from outside, it is possible to lock and unlock the doors from inside by pressing the **»» Fig. 122** button, even without the key in the ignition.

Locking of all doors, the boot lid and the fuel tank flap¹⁾

– Press the button  **»» Fig. 122**. The warning lamp  on the button will light up.

Unlocking of all doors, the boot lid and the fuel tank cap¹⁾

– Press the button  **»» Fig. 122**. The warning lamp  on the button will switch off.

If the vehicle has been locked using the central lock button.

- The rear lid cannot be unlocked from the outside (security measure, e.g. when stopped at an intersection).
- The doors can be unlocked individually by pulling the handle.
- The vehicle doors cannot be locked if any of the doors are open.
- In the event of an accident in which the airbags activate, doors locked from the inside will be automatically unlocked for easier access and assistance.

⚠ WARNING

The central locking system remains operative when the ignition is switched off. Never leave children unattended in the vehicle, as doors locked from the inside delay assistance in an emergency. Risk of sustaining fatal injuries!

Note

The handles and the central lock buttons will not work if the Safe lock **»»** page 112 is activated.

Unlocking and locking the vehicle with Keyless Access

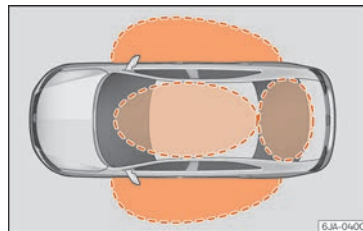

Fig. 123 Keyless Access locking and ignition system: nearby areas.

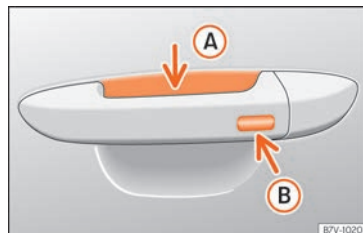

Fig. 124 Locking and ignition system without Keyless Access: sensor surface **A** for unlocking inside the door handle and sensor surface **B** for locking on the exterior of the handle. **»»**

¹⁾ Valid for vehicles with a keyless fuel tank cap.

Keyless Access is a key-free locking and ignition system to unlock and lock the vehicle without actively using its key. For this, all that is required is to have a valid vehicle key near »» Fig. 123 the vehicle and one of the sensor surfaces on the door handles to be touched »» Fig. 124.

General information

If a valid key is in the proximity of the car »» Fig. 123, the Keyless Access locking and starting system gives the key entry as soon as one of the sensor surfaces on the door handles is touched or the push button on the boot hatch is operated. The following features are then available without having to use the vehicle key actively:

- Keyless-Entry: unlocking of the vehicle with the handles on the four doors or the button located on the boot hatch.
- Keyless-Go: engine ignition and driving. For this to occur, there has to be a valid key inside the vehicle and the ignition push button needs to be pressed »» page 197..
- Keyless-Exit: unlocking of the vehicle with one of the four door handle.

The central locking and locking systems operate in the same way as a *normal* locking and unlocking system. Only the controls change.

Unlocking the vehicle is confirmed with a *double* flash of the indicator lights; locking by a *single* flash.

The vehicle will lock again after a few seconds if you unlock the vehicle but fail to open any door or boot hatch.

Unlocking and opening the doors (Keyless-Entry)

- Grip the door handle. In doing this, the sensor surface »» Fig. 124 A (arrow) on the handle is touched and the vehicle unlocks.
- Open the door.

In vehicles without safety system "Safe": closing and locking the doors (Keyless-Exit)

- Switch the ignition off.
- Close the driver's door.
- Touch (once) the sensor surface B (arrow) on the door handle. The door that is used must be closed.

In vehicles with safety system "Safe": closing and locking the doors (Keyless-Exit)

- Switch the ignition off.
- Close the driver's door.
- Touch (once) the sensor surface B (arrow) on the door handle. The vehicle locks with the

"Safe" security system »» page 112. The door that is used must be closed.

- Touch (twice) the sensor surface B (arrow) on the door handle to lock the vehicle without the "Safe" security system »» page 112.

Unlocking and locking the boot hatch

When the vehicle is locked, the hatch automatically unlocks on opening if »» Fig. 123 there is a valid vehicle key in the proximity.

Open or close the hatch *normally* »» page 117.

After closing, the hatch locks automatically. In the following instances, the rear lid does **not** lock automatically after closing:

- If the entire vehicle is unlocked.
- If the key used last is inside the vehicle. All vehicle indicator lights flash *four times*. The vehicle will lock again after a few seconds if no door or boot hatch are opened.

Locking the vehicle with a second key

If there is a vehicle key inside the vehicle and it is locked from the outside with a second vehicle key, the key inside the vehicle is blocked for engine ignition »» page 196. In order to enable engine ignition, the  button on the key inside the vehicle needs to be pressed »» page 108.

Automatically disabling sensors

If the vehicle is not locked or unlocked for a long period of time, the proximity sensor on the passenger door is automatically disabled.

If one of the sensor surfaces on the door handles is often activated in an unusual manner with the vehicle locked (e.g. by the branches of a bush rubbing against it), all proximity sensors are disabled for a time. If this only happens with the exterior sensor on the driver's door, only this sensor is disabled.

Sensors will again be enabled:

- After a time.
- **OR:** if the vehicle is unlocked with the button  on the key.
- **OR:** if the boot is opened.

Keyless Access temporary disconnection function*

You can deactivate the vehicle's Keyless Access unlocking for a locking and unlocking cycle.

- Move the gear lever to position **P** (if the vehicle has automatic gearbox), since otherwise the vehicle cannot be locked.
- Close the door.
- Push the central locking button  on the remote control and touch the locking sensor surface **>>> Fig. 124 (B)** on the driver door han-

dle once within the following 5 seconds. Do not grab the handle or the vehicle will not lock. Deactivation is also possible if the vehicle is locked through the driver's door lock.

- To check that the function has been deactivated, wait at least 10 seconds, grip and pull on the door handle. The door should not open.

The next time the door can only be unlocked via the remote control or the lock cylinder. The next time the door is locked/unlocked, Keyless Access will be active again.

Convenience functions

To close all electric windows, the sliding roof and electric tilting panoramic roof **with the convenience feature**, keep your finger on the lock sensor surface **(B)** located on the exterior part of the driver or passenger door handle for a few seconds until the windows and roof close.

The **doors opened** by touching the sensor surface of the door handle depend on the settings that have been activated in the Easy Connect system with the **(CAR)** button and the **(SETTINGS)** and **(Opening and closing)** function buttons.

⚠ CAUTION

The sensor surfaces on the door handles could engage if hit with a water jet or high pressure steam if there is a valid vehicle

key in the proximity. If at least one of the windows is open and the sensor surface **(B) on one of the handles is activated continuously, all windows will close. If the water jet or steam is briefly moved away from the sensor surface **(A)** on one of the handles and then pointed at it again, all the windows will probably open >>> page 115, Convenience functions.**

Note

- **If the vehicle battery has little or no charge, or the vehicle key battery is almost or entirely out of charge, you will probably not be able to lock or unlock the vehicle with the Keyless Access system. The vehicle can be unlocked or locked manually >>>  page 11.**
- **If there is no valid key inside the vehicle or the system fails to detect one, a warning will display on the dash panel screen. This could happen if any other radio frequency signal interferes with the key signal (e.g. from a mobile device accessory) or if the key is covered by another object (e.g. an aluminium case).**
- **If the sensors are very dirty, e.g. have a layer of salt, the correct functioning of the sensors on the door handles may be affected. If this is the case, wash the vehicle >>> page 265.**
- **If the vehicle is equipped with an automatic gearbox, it may only be locked in the gear stick is in position P.**

- To improve the safety of your vehicle, the remote control of the system is equipped with a position sensor. If this remote control does not detect movement for a certain length of time, the system will conclude that the vehicle cannot be opened (e.g. on a night table) so it will be disabled.

Child-proof locking



Fig. 125 Activating the childproof lock.

The childproof lock prevents the rear doors from being opened from the inside. Doors can only be opened from the outside.

The childproof lock is activated and deactivated using the ignition key.

Activating the childproof lock

- Turn the slot in the direction of the arrow »» Fig. 125 (in the other direction on the right-hand door).

Deactivating the childproof lock

- Turn the slot in the opposite direction of the arrow (in the other direction on the right-hand door).

Anti-theft alarm*

General notes

The anti-theft alarm system increases vehicle protection from intruders. The system will initiate acoustic and optical warning signals when your vehicle is tried to be forced.

Activating the alarm system

The anti-theft alarm switches on automatically when the vehicle is locked using the remote control key or inserting the key in the driver door. The alarm is activated around 30 seconds after the vehicle is locked.

Deactivating the alarm system

The anti-theft alarm system is deactivated when the remote control unlock button is pressed. If the vehicle is not opened within 30 seconds after emitting the radio frequency signal, the system will be reactivated.

If the vehicle is unlocked using by inserting the key in the driver door, the ignition must be switched on within 15 seconds. This deacti-

vates the alarm system. If, during these 15 seconds, **the vehicle is not started, the alarm is triggered.**

When does the system trigger an alarm?

The following areas of the vehicle are monitored:

- Bonnet
- rear lid;
- Doors
- Ignition
- Tilt angle »» page 117, Vehicle interior monitoring and anti-tow system
- The interior »» page 117, Vehicle interior monitoring and anti-tow system
- Drop in voltage in the car systems
- The factory-fitted towing bracket

The alarm is triggered immediately if one of the battery cables is disconnected while the alarm system is active.

How to turn OFF the alarm

To deactivate the alarm, press the unlock button on the remote control key or switch on the ignition.

i Note

- **The alarm horn power supply has a 5-year useful life. Contact an Official Service for more detailed information.**

- To make sure that the anti-theft alarm is fully operative when leaving the vehicle, check that all the doors and windows are closed.
- Remote control and receiver unit coding means that the remote control cannot be used on other vehicles.

Vehicle interior monitoring and anti-tow system

The Vehicle interior monitoring system is activated if movements are detected in the interior of the vehicle.

Switching off the vehicle interior monitoring and tow-away protection*

When the vehicle is locked, the alarm will be triggered if movements are detected in the interior (e.g. by animals) or if the vehicle's inclination is changed (e.g. during transport). You can prevent the alarm from being triggered accidentally by switching off the vehicle interior monitoring and/or tow-away protection.

- To switch off the interior monitoring and tow-away protection, switch off the ignition and, using the Infotainment system, select: Infotainment button **(CAR)** /  and then the **SETTINGS > Opening and closing > Central locking > Vehicle interior monitoring** button.

- When the vehicle is locked now, the vehicle interior monitoring and the tow-away protection are switched off until the next time the door is opened.

If the anti-theft security system [Safe]* **>>>** page 112 is switched off, the vehicle interior monitoring and the tow-away protection are automatically switched off.

WARNING

Observe the safety warnings **>>>**  in General notes on page 111.

Note

- The vehicle interior monitoring system and the tow-away protection system must be deactivated if there is a danger of the alarm being triggered due to movements by children or animals in the interior when being transported (e.g. by boat or by train) or towed.
- The effectiveness of the Vehicle interior monitoring system is reduced if the spectacle case is left open. Always close the storage compartment before locking the vehicle to ensure that this monitoring system operates correctly.

Rear lid

Opening and closing



Fig. 126 Rear lid: opening from the outside.

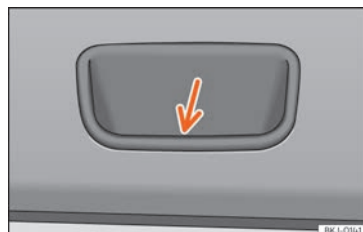





Fig. 127 Close-up of the inside trim of the rear lid: space for pulling.

Read the additional information carefully **>>>**  page 12 **>>**

The rear lid opening system operates electrically. It is activated by using the handle on the boot lid.

This system may or may not be operative, depending on the situation of the vehicle.

If the rear lid is locked then it cannot be opened, however if it is unlocked then the opening system is operative and the rear lid may be opened.

To lock/unlock, press the  button or the  button on the remote control key.

A warning appears on the instrument panel display if the boot lid is open or not properly closed.* An audible warning is also given if the boot lid is opened while the vehicle is moving faster than 6 km/h (4 mph)*.

WARNING

- Always close the rear lid properly. Risk of accident or injury.
- Do not close the rear lid by pushing it down with your hand on the rear window. The glass could smash. Risk of injury!
- Ensure the rear lid is locked after closing it. If not, it may open unexpectedly while driving.
- Never allow children to play in or around the vehicle. A locked vehicle can be subjected to extremely high and low temperatures, depending on the time of year, thus causing serious injuries/illness. It could even have fatal consequences. Close and

lock both the rear lid and all the other doors when you are not using the vehicle.



- Closing the rear lid without observing and ensuring it is clear could cause serious injury to you and to third parties. Make sure that no one is in the path of the rear lid.
- Never drive with the rear lid open or half-closed, exhaust gases may penetrate into the interior of the vehicle. Danger of poisoning!
- If you only open the rear lid, do not leave the key inside. The vehicle will not be opened if the key is left inside.

Note



- Once the rear lid is closed, its lock is engaged and the alarm system is activated. Only valid if the vehicle has been locked before the rear lid is closed.
- The release catch located at the top of the registration plate recess is deactivated on accelerating or at speeds of over 5 km/h (3 mph). The catch is reactivated when the vehicle comes to a standstill and a door is opened.

Rear lid automatic locking

Where the vehicle has been locked by pressing the  button on the remote control with the rear lid open, the rear lid will lock automatically when closed.

The automatic rear lid locking time extension function can be activated. When this function is activated and once the rear lid has been unlocked by pressing the  button on the remote control key  page 108, the boot lid can be re-opened for a certain length of time.

Where required, the automatic boot lid locking time extension function can be activated or deactivated at a SEAT Authorised Service, which will provide all of the necessary information.

Before the vehicle locks automatically, there is a risk of intruders getting into the vehicle. Therefore, we recommend you always lock the vehicle by pressing the  button on the remote control or by using the key without remote control  page 112.

Controls for the windows

Operation of the electric windows

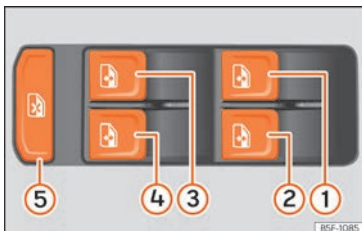

Fig. 128 Detail of the driver door: controls for the windows.

Read the additional information carefully

» page 14

The electric window opening and closing system only works when the ignition is switched on.

Opening

- Press gently on the respective button on the door to open the window. The process will stop when the button is released.
- The driver door window can also be automatically opened by pressing the button as far as it will go (fully open). Press the button again to immediately stop it.

Closing

- Press the respective button gently to close the window. The process will stop when the button is released.

Safety button

Press the safety button **Fig. 128 5** to deactivate the controls on the rear doors. Pressing the safety button **5** again will reactivate the controls on the rear doors.

If the rear door controls are deactivated, the warning lamp on the safety button **5** will light up.

WARNING

- When locking the vehicle from the outside, make sure that nobody is inside the vehicle, as the windows cannot be opened from the inside in an emergency.
- For safety reasons, use the safety button **5** that deactivates the window switches on the rear doors when children are travelling in the rear seats.

CAUTION

- Keep the windows clean to ensure the system operates correctly.
- Defrost page 269 any frozen windows before using the electric windows. Otherwise you run the risk of damaging the electric window riser mechanism.

- Always make sure all of the windows are closed on leaving the locked vehicle.

Note

- The vehicle heating and ventilation system should be used to ventilate the interior while driving. Leaving the windows open could allow dust and other dirt to enter the vehicle and cause unpleasant noises at certain speeds.
- Do not leave the side windows open at high speeds, as this will overly increase fuel consumption.

Note

The electric window opening mechanism is equipped with a thermostat switch. This may overheat if the window is opened and closed repeatedly. This causes the window to lock temporarily. Once the thermostat switch has cooled down, the window can be operated once again.

Roll-back function on the electric windows

The electric windows are equipped with a roll-back system that reduces risk of injury when closing windows.

If an obstacle is present, the closing mechanism will stop and the window will roll back a few centimetres.

If an obstacle prevents closing for the next 10 seconds, the closing mechanism will once again stop and the window will roll back another few centimetres.

If in the next 10 seconds you attempt to close the window after it has rolled back the second time, only the closing mechanism will be stopped even if the obstacle is still present. The roll-back function is still connected.

The roll-back function will only be disconnected if you once again attempt to close the window in the following 10 seconds. **In this case, the window will close at full force.**

If you wait for a further 10 seconds, the roll-back function will be once again connected.

Lights and visibility

Lights

Introduction

Read the additional information carefully

»  page 21

The location of the controls of **right-hand drive** cars differs slightly from the location shown here » **Fig. 129** » page 121. However, the symbols indicating the respective positions of the controls remain the same.

WARNING

Never drive with only the side lights on! The side lights are not bright enough to illuminate the road ahead and to ensure that other road users are able to see you. Always use your dipped beam headlights if it is dark or if visibility is poor.

CAUTION

- Use the lights in line with local law.
- However, drivers always remain responsible for correctly adjusting and using the lights.

Note

- An audible warning will be heard when the light control is set to  and you remove

the ignition key and open the door. Once the driver door is closed (ignition off), the audible warning will stop, whereas the side lights will remain on to light up the stationary vehicle in case this is necessary.

- Depending on weather conditions (cold or wet), the lights may mist up temporarily on the inside. This is particularly the case in the event of a difference in temperature between the inside and in front of the light. By switching on the lights, the area through which the beam of light is projected will quickly be demisted, although the edges may remain misted. The rear lights and turn signals can mist up. This has no influence on the useful life of the lighting system.

Control lamps

 It lights up

Rear fog light switched on » page 124.

 It lights up

Front fog lights* switched on » page 124.

 It lights up

Left or right turn signal.
The control lamp flashes twice as fast when a turn signal is faulty » page 122.

It lights up

Main beam on or flasher on »» page 122.

It lights up

Bulb failure »» page 86

For example, the information display indicates:
Check front right dipped headlight!

Several warning and control lamps light up for a few seconds when the ignition is switched on, signalling that the function is being verified. They will switch off after a few seconds.

WARNING

Observe the safety warnings »» **!** in Control and warning lamps on page 103.

Note

The rear side lights and number plate light contain several bulbs. The control lamp **!** lights up only when there is a fault in all the number plate bulbs or side light bulbs (of a combined tail light). Therefore it is advisable to regularly check the bulb operation.

Side light and dipped beam headlight

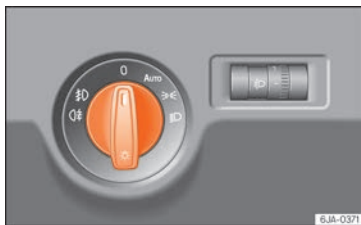

Fig. 129 Instrument panel: light panel.

Switching the side lights on

– Turn the light switch »» **Fig. 129** to position **!**.

Switching on dipped beam

– Turn the light switch »» **Fig. 129** to position **!**.

Switching off lights (except daytime driving lights)

– Turn the light switch »» **Fig. 129** to position **0**.

Headlight range control



Fig. 130 Instrument panel: light range control.

– Turn the control »» **Fig. 130** to set the lights to the required setting.

Positions

The control positions roughly correspond to the following vehicle load conditions.

- ① Two front occupants, luggage compartment empty.
- ② All seats occupied, luggage compartment empty.
- ③ All seats occupied, luggage compartment fully loaded.
- ④ Driver only, luggage compartment fully loaded.

CAUTION

Always adjust the range of the lights so that:



- your vehicle does not dazzle others, particularly oncoming traffic;
- the range of the headlights is sufficient for safe driving.

i Note

Make sure you set the range of the main lights when the dipped beam headlights are switched on.

Daytime running lights

Daytime running lights are signalling devices for improving road safety. The lights are built into the headlights and come on each time the ignition is turned on if the light switch is in position 0 or AUTO >>> Fig. 129. It is automatically switched off when the side lights are turned on.

Switching the daytime driving lights on

- Remove the key from the ignition, move the turn signal lever upward (right turn signal), press it back to flash position and hold it there.
- Insert the key and switch on the ignition, holding it in this position for 3 seconds. Then, switch off the ignition. The daytime running light is now activated and the corresponding lights can come on.

Switching the daytime running light off

- Remove the key from the ignition, press the turn signal lever down (left turn signal), press it back to flash position and hold it here.
- Insert the key and switch on the ignition, holding it in this position for 3 seconds. Then, switch off the ignition. The daytime running light is now deactivated and the corresponding lights cannot come on.

OR: activate and deactivate the daytime lights using the Easy Connect system >>> page 24.

Automatic control of the dipped beam in combination with the daytime running lights

If the *dipped beam control* and the *daytime running lights* are activated at the same time, the dipped beams and the instrument panel lighting will automatically come on as required (e.g. when entering a tunnel) and the daytime running lights will switch off. When the automatic dipped beam control switches off the dipped beams (e.g. when coming out of a tunnel), the daytime running lights come back on.

⚠ WARNING

On vehicles with rear lights with bulbs, when activating the daytime running light the rear lights are not switched on. A vehicle which does not have the rear lights on

may not be visible to other drivers in the darkness, in the case of heavy rain or in conditions of poor visibility.

i Note

Please observe any relevant legal requirements which may apply in your country.

Turn signal and main beam headlights lever

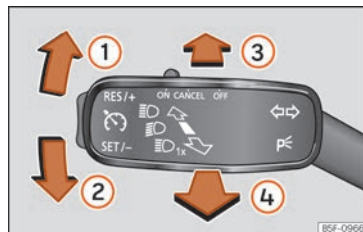

Fig. 131 Turn signal and main beam lever.

The turn signal and main beam lever also operates the parking lights and the headlight flasher.

Right and left-hand ⇄ turn signal ⇄

- Move the lever >>> Fig. 131 up ① or down ②.
- Keep the lever held down at the point of resistance for the turn signals to flash for as

long as you hold the lever, e.g. when changing lanes.

Convenience turn signals

For the convenience turn signals, move the lever as far as possible upwards or downwards and release the lever. The turn signal will flash three times.

The convenience turn signals are activated and deactivated in the Easy Connect system via the **(CAR)** button and the **(SETTINGS)** function button »»»  page 24.

In vehicles that do not have the corresponding menu, this function can be deactivated in a specialised workshop.

Main beams

- Switch on the dipped beam »»» page 121.
- Press the lever »»» Fig. 131 forward in the direction indicated by arrow **(3)**.
- Pull the lever back to its original position in the direction indicated by arrow **(4)** to switch the main beam off.

Headlight flasher

- Pull the lever »»» Fig. 131 towards the steering wheel (point of resistance) in the direction indicated by arrow **(4)**.



Parking lights

- Instructions for use »»» page 125.

CAUTION

Never use the main beam headlights or the headlight flasher if they could dazzle other drivers.

Note

- If the convenience turn signals are operating (three flashes) and the other convenience turn signals are switched on, the active part stops flashing and only flashes once in the new part selected.
- The turn signals only work when the ignition is switched on. The corresponding warning lamp  or  flashes in the general instrument panel.
- The turn signals switch off automatically when the steering wheel is returned to the straight-ahead position.
- If a turn signal bulb is defective, the control lamp flashes at double speed.

Automatic dipped beam control AUTO*

The automatic dipped beam control is merely intended as an aid and is not able to recognise all driving situations.

When the light switch is in position **AUTO**, the vehicle lights and the instrument panel and switch lighting switch on and off automatical-

ly in the following situations »»»  in Daytime running lights on page 122:

Automatic switching on	Automatic switching off
The photo sensor detects <i>darkness</i> , for example, when driving through a tunnel.	When adequate lighting is detected.
The rain sensor detects rain and activates the windscreen wipers.	When the windscreen wipers have been inactive for a few minutes.

WARNING

If the road is not well lit and other road users cannot see the vehicle well enough or at all, accidents may occur.

- The automatic dipped beam control (**AUTO**) only switches on the dipped beam when there are no changes in brightness, and not, for example when it is foggy.

Fog lights*

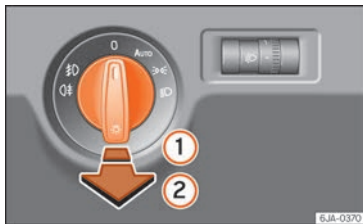

Fig. 132 Instrument panel: light panel.

Switching on front fog lights

- First turn the light switch »» Fig. 132 to position **AUTO**, ☞☞ or ☞☞.
- Pull on the light switch to position ①.

The ☞☞ warning lamp lights up on the general instrument panel if the front fog lights are switched on.

Fog lights with cornering light function

✓ Not available on vehicles equipped with full-LED headlights and bulb fog lights.

The *cornering* light function is an additional function to the dipped beam headlights to improve lighting of the side of the road when taking a sharp turn at low speed.

The *cornering* light function works when the dipped beam headlights are already on and it is enabled when driving at speeds below approximately 40 km/h (25 mph).

Forward gear

- If the steering wheel is turned to the right or the right-hand turn signal switched on, the right-hand fog lamp is gradually switched on.
- If the steering wheel is turned to the left or the left-hand turn signal switched on, the left-hand fog lamp is gradually switched on.
- After the turn, the *cornering* light function is gradually switched off.

Reverse gear

- When engaging the reverse gear, both fog lights turn on.

Rear fog light

Switching on the rear fog light

- First turn the light switch »» Fig. 132 »» page 124 to position **AUTO**, ☞☞ or ☞☞.
- Pull on the light switch to position ②.

If the vehicle is not equipped with front fog lights »» page 124, the rear fog light is switched on by turning the switch to position ☞☞ or ☞☞ and pulling it to position ②. This type of switch only has one position.

The ☞☞ »» page 103 warning lamp lights up on the general instrument panel if the rear fog lights are switched on.

If you are towing a trailer or caravan equipped with a rear fog light on a vehicle with a **factory-fitted towing bracket or one installed using parts from the original SEAT parts catalogue**, only the rear fog light on the trailer or caravan will light up.

Function “Coming Home”/“Leaving Home”*

This function makes it possible, under poor visibility conditions, to automatically turn on the lights for a brief period of time after the vehicle has been parked or when approaching the vehicle.

The function is automatically turned on if the following conditions are met:

- The light switch is in position **AUTO** »» page 123.
- The visibility around the vehicle is reduced.
- The ignition is switched off.

To turn on this function, switch on the headlight flasher prior to exiting the vehicle.

The light is adjusted according to the data recorded by the light sensor that is installed between the windscreen and the inside rear view mirror.

The function automatically turns on the side lights and headlights, the lighting for the entry area on the exterior mirrors and the number plate light.

“Coming Home” function

The light is automatically switched on when the driver door is opened (for 60 seconds after the ignition is switched off).

The light is switched off when all the doors and the rear lid are closed.

If a door or the rear lid remains open, the light will switch off after 60 seconds.

“Leaving Home” function

The light is automatically switched on when the vehicle is unlocked using the remote control.

The light is switched off after 10 seconds or when the vehicle is locked.

Hazard warning lights switch



Fig. 133 Instrument panel: switch for hazard warning lights.

- Press the button  **Fig. 133** to switch the hazard warning lights on or off.

The warning lamps on the instrument panel and the warning lamp on the switch will flash at the same time as the turn signals when the hazard warning lights are switched on. The hazard warning lights also work when the ignition is switched off.

The hazard warning lights come on automatically in the event of an accident in which an airbag is triggered.

Note

Switch on the hazard warning lights to warn other road users, for example:

- **When reaching the tail end of a traffic jam**

- **if the vehicle has a technical fault or you are involved in an emergency situation.**

Parking lights*

Parking lights P \leq

- Switch the ignition off.
- Move the turn signal lever **»» Fig. 131** **»» page 122** up or down to turn on the right or left-hand parking lights respectively.

Parking light on both sides

- Turn the light switch **»» Fig. 129 ** **»» page 121** to position **» \leftarrow** and engage the steering lock.

Note

- **The parking lights P \leq can only be activated with the ignition disconnected.**
- **The parking light will not come on automatically after switching off the ignition if the left- or right-hand turn signal is left on.**

Driving abroad

The light beam of the dipped beam lights is asymmetric: the side of the road on which you are driving is lit more intensely. **»**

When a car that is manufactured in a country that drives on the right travels to a country that drives on the left (or vice versa), it is normally necessary to cover part of the headlight bulbs with stickers or to change the adjustment of the headlights to avoid dazzling other drivers.

In such cases, the regulations specify certain light values that must be complied with for designated points of the light distribution. This is known as "Tourist light".

The light distribution of the halogen and full-LED headlights allows the specific "tourist light" values to be met without the need for stickers or changes in the settings.

Note

"Tourist light" is only allowed temporarily. If you are planning a long stay in a country that drives on the other side, you should take the vehicle to an Authorised Technical Service to change the headlights.

Interior lights

Interior lighting

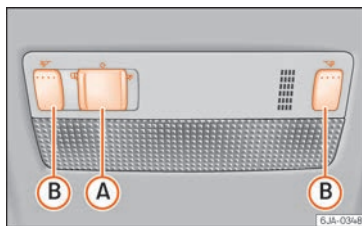

Fig. 134 Interior lighting – version 1.

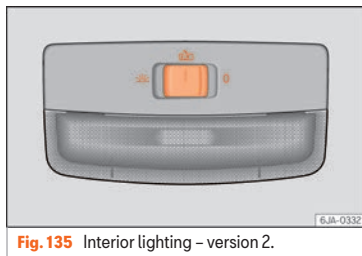



Fig. 135 Interior lighting – version 2.

Read the additional information carefully

»»  page 22

Where the courtesy light is on (switch **A**) »» Fig. 134 in position , the light will come on if:

- the vehicle is unlocked,
- one of the doors is opened,
- The key is removed from the ignition

When the courtesy light is on (switch **A** in position , the light will switch off if:

- the vehicle is locked,
- the ignition is switched on,
- 30 seconds after all of the doors have been closed

If a door is left open or if switch **A** is in the  position, the interior lighting switches off after about 10 minutes to prevent the battery from running flat.

Rear interior light



Fig. 136 Rear interior light.

Press the button »» Fig. 136 to switch the lighting on or off.

Interior lights / ambient light*

The lighting of the central console area, the door handles, the storage pockets in the front doors and the footwell area will switch on fully when the doors are opened and will decrease in intensity while driving with the dipped beam headlights on.

Depending on the version, a logo is back-lit on the front passenger's side of the dash panel. This light comes on when the dipped beam is activated.

The intensity of the ambient light* can be adjusted using the menu **Easy Connect** > **Lighting settings** > **Vehicle interior Lighting** »»  page 24.

Glove box light

The light will come on automatically when the glove compartment is opened. The light will go out when the glove compartment is closed.

Luggage compartment light

The light switches on automatically when the boot is open and switches off automatically 10 minutes after the boot lid has been opened.

Visibility

Heated rear window



Fig. 137 Heated rear window switch.

- Switch the heated rear window on or off by pressing the  button »» Fig. 137, the warning lamp in the button will come on or go off respectively.

The heated rear window only works when the engine is running.

After approximately 7 minutes, the heating device of the rear window **switches off** automatically.

For the sake of the environment

The heated rear window should be switched off as soon as the glass is demisted. By saving electrical power you can also save fuel »» page 211.

Note

In the event of a drop in voltage in the on-board systems, the heated rear window switches off automatically to ensure enough power to control the engine »» page 255, Automatic disconnection of electrical equipment.

Sun visors

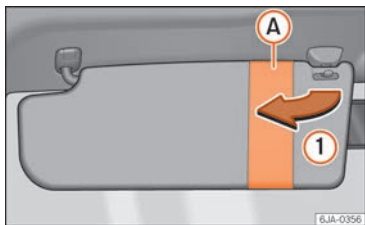

Fig. 138 Driver's sun visor.

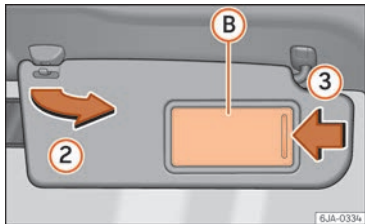

Fig. 139 Front passenger's sun visor.

The sun visors for the driver and the front passenger can be pulled out of their central supports and turned towards the doors in the direction of arrow ① » Fig. 138 and ② » Fig. 139 respectively.

The strip ① is to store small objects such as notepaper, etc.

The front passenger sun visor includes a vanity mirror ② with a cover. The cover is opened by sliding it in the direction indicated by arrow ③ » Fig. 139.

⚠ WARNING

Do not turn sun visors with attached objects such as ball-pens, etc. toward the head protection airbag triggering zone on the side windows. The head airbags could cause lesions to the passengers when activating.

Windscreen wipers and windscreen washers

Control lamp

🚗 It lights up

Windscreen wiper level too low.
Top up the windscreen wiper reservoir as soon as possible » page 251.

Several warning and control lamps light up for a few seconds when the ignition is switched on, signalling that the function is being verified. They will switch off after a few seconds.

Introduction

The windscreen wipers and windscreen washers only work when the ignition is switched on.

The speed of the automatic wipe in case of rain is automatically adjusted according to the intensity of the rainfall.

The rear window is wiped once if the windscreen wipers are switched on and reverse gear is engaged.

Fill the windscreen washer fluid » page 251.

⚠ WARNING

- Make sure the blades » 📖 page 56 are in perfect condition for good visibility and safe driving.
- In cold conditions, you should not use the wash/wipe system unless you have warmed the windscreen with the heating and ventilation system. The windscreen washer fluid could otherwise freeze on the windscreen and obscure your view of the road.

ⓘ CAUTION

- During winter, always check that the windscreen wiper blades are not frozen to the glass before each trip or before switching on the ignition. If you switch on the windscreen wipers when the wiper blades

are frozen to the glass, this could damage both the wiper blades and the wiper motor.

- If the ignition is switched off when the windscreen wipers are on, they will start operating in the same mode when the ignition is switched back on. The wiper blades may be frozen to the glass at low temperatures when the ignition is switched off.
- Carefully separate the frozen wipers from the windscreen or rear window.
- Remove snow and ice from the wipers before starting your journey.
- Careless handling could lead to the wiper arms damaging the windscreen.
- For safety reasons, the wiper blades should be changed once or twice a year. They can be purchased at a SEAT Authorised Service.
- The ignition cannot be switched on while the windscreen wiper arms are in a raised position. Otherwise, the windscreen wipers would return to their original position and could damage the paintwork on the bonnet.

i Note

Keep the wipers clean. The wipers can be soiled with remains of wax solutions from car washes » page 265.

- On vehicles equipped with windscreen washer jets, these are heated once the engine is running.

Operating windscreen wipers and washers

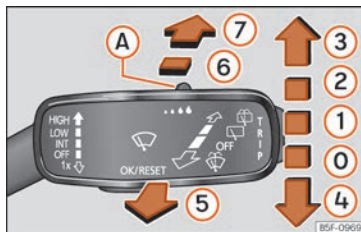

Fig. 140 Window wiper lever.

Short wipe

- Give the windscreen a **brief** wipe by moving the lever down to position **4** » » **Fig. 140**.

Intermittent wipers/automatic wipe with rain sensor*

- Push the lever up to position **1** » » **Fig. 140**.
- With switch **A**, adjust the wipe interval or rain sensor sensitivity.

Switch **A** has 4 positions.

The rain sensor* is part of the intermittent wipe function.

The rain sensor* controls the frequency of the windscreen wiper intervals, depending on the amount of rain.

Slow wipe

- Push the lever up to position **2** » » **Fig. 140**.

Continuous wipe

- Push the lever up to position **3** » » **Fig. 140**.

Automatic windscreen wash and wipe

- Pull the lever towards the steering wheel, position **5** » » **Fig. 140**, and the windscreen washer and wipers are switched on.
- Release the lever. The washer will stop and the windscreen wipers will keep running for 1-3 wipes (depending on the windscreen washer operating time).

Rear window wiper*

- Press the lever forward to position **6** » » **Fig. 140** and the rear window wiper will run every 6 seconds.

Automatic rear window wash and wipe*

- Press the lever fully forward to position **7** » » **Fig. 140** and the rear window wiper and washer switch on at the same time.
- Release the lever. The rear window washer will stop and the rear window wipers will keep running for 1-3 wipes (depending on the jet operating time). **When released, the lever remains in position 6.** » »

Switching off the wipers

- Move the lever to position  »» Fig. 140.

WARNING

The rain sensor may not detect enough rain to switch on the wipers.

- If necessary, switch on the wipers manually when water on the windscreen obstructs visibility.

Note

Do not put stickers on the windscreen in front of the rain sensor*. This may cause sensor disruption or faults.

Headlight washers*

The headlight washers operate briefly if the dipped headlights or headlights are on and the lever is moved to position  »» Fig. 140. The headlight washer system also operates every 10 windscreen wash cycles.

Clean off stubborn dirt (insects, etc.) from the headlights at regular intervals, for instance when filling the fuel tank. Please observe the following indications »» page 265.

To ensure the system works properly in winter, keep the nozzle holders free of snow and remove any ice with a de-icer spray.

CAUTION

Never pull on the nozzle holders. Risk of damage to the system!

Mirrors

Rear view mirror with manual anti-dazzle device

Basic settings

- Push the lever at the bottom of the mirror forward.

Rear vision mirror anti-dazzle setting

- Pull the lever at the bottom of the mirror towards you.

Exterior mirrors

Read the additional information carefully

»»  page 15

Before beginning any journey, adjust the rear view mirrors for a good rear visibility.

WARNING

- Convex (wide-angle) rear vision mirrors give a larger field of vision. However, they make objects appear smaller and further

away than they really are. For this reason, you should not rely on these rear vision mirrors for judging the distance of vehicle behind.

- If possible, use the interior rear vision mirror to estimate distances to vehicles behind you.

Note

- Exterior mirrors are only heated when the engine is running.
- Do not touch the exterior mirrors when the heating system is running.
- If the electrical adjustment should ever fail to operate, the rear vision mirrors can be adjusted by hand by pressing the edge of the mirror glass.
- Visit the technical service in the event of a fault in the electrical rear vision mirror adjustment system.

Seats and head restraints

Adjusting seats and head restraints

Introduction

Read the additional information carefully
»  page 14

Set the driver seat in such a way that the pedals can be fully depressed with your legs slightly bent.

Set the driver seat backrest so that you can reach the upper point of the steering wheel with your arms slightly bent.

The correct seat position is very important for:

- reaching all of the controls safely and quickly,
- a relaxed posture that will not produce fatigue,
- **maximum protection from the seat belts and airbag system**

WARNING

- Adjust the driver seat only when the vehicle is stationary. Risk of accident!

- Be careful when adjusting the front seats! Careless and uncontrolled adjustment can cause injuries.
- The backrests must not be reclined too far back while driving. This could limit the effect of the seat belts and the airbag system. Risk of injury!
- Never transport more than the permitted amount of people in your vehicle.
- Every occupant in the vehicle must properly fasten and wear the seat belt belonging to his or her seat. Children must be protected with an appropriate child restraint system »» page 75, Transporting children safely.
- The front seats, head restraints and seat belts must always be adjusted to the size of the vehicle occupant to provide you and your passengers with the greatest possible protection.
- Your feet should remain in the footwell while the vehicle is moving; never rest them on the dash panel, on the window or on the seat! This also applies to passengers. An incorrect sitting position exposes you to an increased risk of injury in case of a sudden braking or an accident. If the airbag is triggered, you could sustain severe injuries due to an incorrect sitting position!
- It is important for the driver and front passenger to keep a distance of at least 25 cm from the steering wheel and dash panel. Failure to respect the minimum dis-

tance means that the airbag will not protect you. Risk of fatal injury if triggered!

- Objects must not be placed in the footwell, as they could move to the area of the pedals in the event of a braking manoeuvre or change of direction. This would prevent the clutch, brake or accelerator from being pressed.
- Do not place any items on the front passenger seat other than those allowed (e.g. child seat). Risk of accident!

Note

After a certain time, the backrest angle adjustment mechanism may gain a certain amount of play.

Head restraints

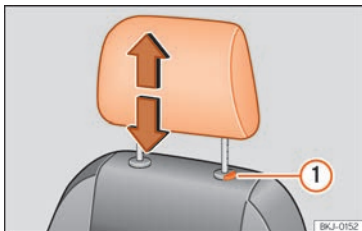

Fig. 141 Front headrest: adjusting or removing.

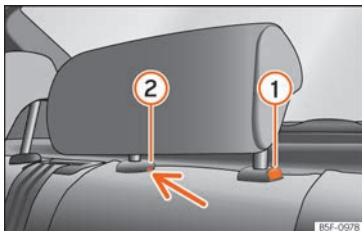

Fig. 142 Rear centre head restraint: release point.

Read the additional information carefully
» page 14

Head restraints cannot be moved up or down or removed on sports seats.

Fitting and removing head restraints on front seats

- Push the head restraint up as far as it will go.
- Press catch ① » **Fig. 141** and remove the head restraint.
- To refit, insert the head restraint into the holes in the backrest, pushing it down until it engages.

Fitting and removing head restraints on rear seats

To remove the head restraint, the corresponding backrest must be partially folded forward.

- Unlock the backrest » **page 134**
- Move the head restraint upwards until it arrives to the top.
- Press button ① » **Fig. 142**, while simultaneously pressing on the security hole ② » **Fig. 142** with a flat screwdriver a maximum of 5 mm wide, and remove the head restraint.
- To refit, insert the head restraint into the holes in the backrest, pushing it down until it engages.

For maximum head restraint protection, adjust the head restraint so that its upper edge is at the same level as the top of your head.

The head restraint must be adjusted in line with the height of users. Correct adjustment of the head restraint, together with the seat belts, ensure effective passenger protection » **page 58**.

WARNING

- **Badly adjusted head restraints increase the risk of injuries in the event of an accident.**
- **Never drive with the head restraints removed. Risk of injuries!**
- **If the seats are in use, never drive with the rear head restraints in their out-of-use position.**

Seat functions

Heated front seats*

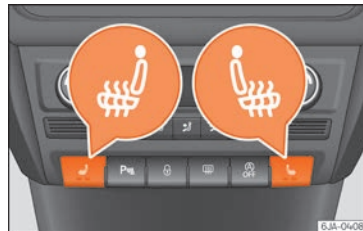



Fig. 143 Heated front seats.

The cushion and backrest of the front seats can be heated electrically.

Press the  or  button **»» Fig. 143** to switch on and adjust the heated front seats.

Press once to connect the heating at maximum force.

Press the button again to reduce the force of the heating and switch it off. The force is indicated by the number of warning lamps lit on the button.

WARNING

Do not use the heated seat if your perception of pain and/or temperature or that of your passenger is limited, e.g. due to medication, paralysis or chronic illness (e.g. diabetes). It could cause burns on the back, buttocks and legs that are difficult to heal. If you still want to use the heated seat, take frequent breaks on long journeys so that the body can recover from the trip. Ask your doctor about your particular situation.

CAUTION

- To avoid damaging the heating elements, do not kneel on the seat or apply sharp pressure at a single point to the seat cushion or backrest.
- Do not use the heated seats if nobody is sitting on them or if there are items attached to or lying on them, such as a child seat

or a bag, etc. The seat heating elements could have a fault.

- Do not clean the seats with anything damp **»» page 268.**

Note

- Only connect the heated seats when the engine is running. This provides considerable savings on the battery capacity.
- In the event of a drop in voltage in the on-board systems, the heated seats switch off automatically to ensure enough power to control the engine **»» page 255, Automatic disconnection of electrical equipment.**

Armrest on front seats with inner storage*

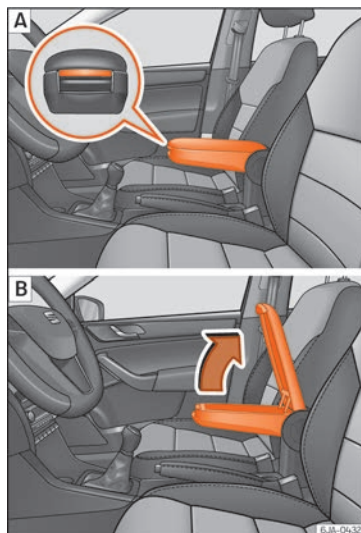

Fig. 144 Armrest/Opening and closing the storage compartment.

Adjusting armrest height

- Lift the armrest as far as it will go and then fold it downward. **»**

- Raise the armrest until it engages in one of the 5 positions.

Opening storage compartment

- Press the button located on the front of the armrest »» Fig. 144 - [A].
- Lift the storage compartment lid »» Fig. 144 - [B].

Armrest on rear seats



Fig. 145 Rear side seats: armrest.

The armrest can be folded away for greater comfort using the handle »» Fig. 145.

Folding down the backrest

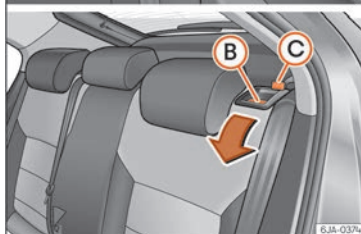
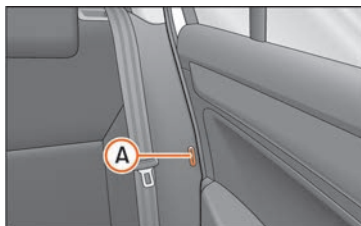

Fig. 146 Unlocking the backrest.

Folding

- Before folding the rear seats, adjust the position of the front seats so that the rear seats are not damaged. When the front seats are adjusted to the rear position, their head restraints should be removed before folding the backrests on the rear seats. Store the removed head restraints in such a

way that they cannot be soiled or damaged.

- Insert the seat belt latch plate into hole [A] »» Fig. 146 located on the corresponding side of the vehicle – safety position.
- Press the lock button [B] to unlock the backrest and fold it forward.

Returning to the initial position

- Where the head restraint has been removed, insert it into the backrest when partially raised.
- Push the backrest backwards to its original position until the lock button engages – check that it is locked by pulling on the backrest »» [!].
- Make sure the red protruding part [C] is not visible.

⚠ WARNING

- Once the backrests have been lifted, the seat belts and their buckles must be in their initial position – ready for use.
- The backrests must be safely locked to ensure any items in the boot cannot move around the interior of the vehicle in the event of a sudden braking manoeuvre. Risk of injuries!

- Make sure the rear backrests are correctly locked. Only then will the three-point automatic seat belt on the rear central seat work correctly.

ⓘ CAUTION

Take care when handling the rear backrests so as not to damage the seat belts. The seat belt must never be left behind the lifted backrest.

Transport and practical equipment

Practical equipment

Passenger side storage compartment



Fig. 147 Instrument panel: passenger side glove compartment.

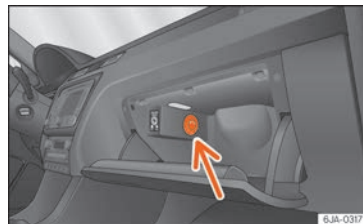

Fig. 148 Storage compartment: cooling control.

Opening and closing passenger side glove compartment

- Pull the catch on the lid in the direction indicated by the arrow »» Fig. 147 and open the lid.
- Close the lid and push it until it engages.

Depending on the vehicle equipment, the CD player is located in the glove compartment. Separate operating instructions are enclosed for this equipment in the corresponding Instruction Manual.

Glove compartment cooling*

Open or close the air outlet by turning the thumbwheel »» Fig. 148.

If the air outlet is open and the air conditioning is on, the cooled air will be released into the glove compartment. »

If the air outlet is open and the air conditioning is off, outdoor air (not conditioned) will be released into the glove compartment.

The air outlet should be closed if the air conditioning is being used in heating mode or where glove compartment cooling is not in use.

⚠ WARNING

- For safety reasons, all storage compartments must be closed while the vehicle is moving.
- Never place any objects on the instrument panel. These objects could be flown around the interior while the vehicle is moving (on accelerating or turning) and distract you. Risk of accident!
- Make sure objects remain in the centre console or other compartments while the vehicle is moving. Otherwise, this could prevent you from braking, changing gear or accelerating. Risk of accident!

i Note

The glove compartment can hold a bottle no larger than 1 litre.

Storage compartment for reflective vest



Fig. 149 Driver's seat: storage compartment.

There is a compartment below the driver seat »» Fig. 149 to store the reflective vests.

⚠ WARNING

The compartment is solely designed to store the reflective vest and no other objects. Objects falling out of the storage compartment could limit or prevent use of the pedals.

ⓘ CAUTION

The compartment is solely designed to store the reflective vest and no other objects, since there is a risk of damaging the storage compartment.

Storage pocket under the front seats

There is a storage pocket on the rear part of the backrest of the front seats.

These pockets are designed to hold maps, magazines, etc.

⚠ WARNING

Do not place heavy objects in the pockets. Risk of injury!

ⓘ CAUTION

Do not place overly large objects in the pockets (e.g. bottles) or objects with sharp edges. Risk of damage to the pockets and the upholstery.

Drink holder in the centre console

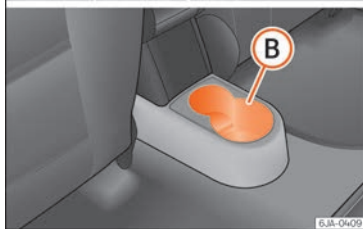
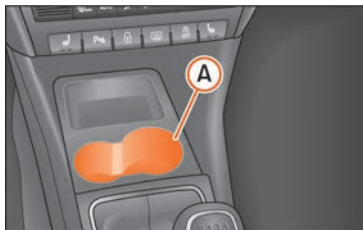

Fig. 150 Centre console: drinks holder.

- A Front drink holder in the centre console
- B Rear drink holder in the centre console

⚠ WARNING

- Do not put hot drinks in the drink holders. They could spill while the vehicle is moving. Risk of scalding!
- Do not use cups or glasses made of fragile materials (e.g. glass or china). These

could cause injury in the event of an accident.

ⓘ CAUTION

Avoid putting open drinks containers in the drink holder while the vehicle is moving. They could spill (e.g. on braking) and cause damage to the electrical equipment or the seat covers.

Drink holder in rear seat armrest

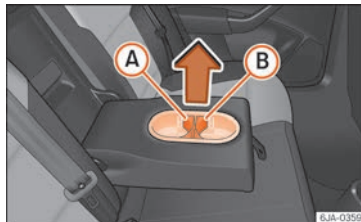

Fig. 151 Rear seats armrest: drink holder.

Two drinks can be placed in the drink holder.

Use the detachable parts A and B »» Fig. 151 to change the size of the holes.

- Remove part A or B in the direction indicated by the arrow and replace in the required position in the drink holder.

Cigarette lighter*

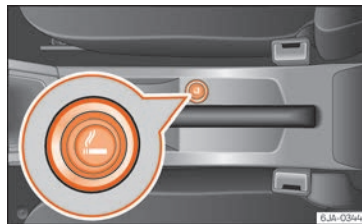

Fig. 152 Centre console: lighter.

The cigarette lighter is located at the front of the centre console »» Fig. 152.

Using the cigarette lighter

- Press the cigarette lighter knob »» Fig. 152.
- Wait for the lighter to spring out.
- Pull out the cigarette lighter and light the cigarette on the glowing coil immediately.
- Put the cigarette lighter back in its socket.

⚠ WARNING

- Take care when using the cigarette lighter! Carelessness or negligence when using the cigarette lighter can cause burns and serious injuries.
- The cigarette lighter also works when the ignition is off and when the ignition key is »»

removed. Therefore, never leave children unsupervised in the vehicle.

Note

- The 12 V power socket of the cigarette lighter can also be used as a power source for electrical appliances »» page 138, Power sockets.
- Additional information »» page 240, Accessories and modifications to the vehicle.

Ashtrays*

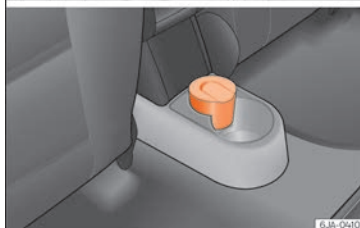

Fig. 153 Centre console: front ashtray/rear ashtray.

Removing the ashtray

- Pull the ashtray »» **Fig. 153** upwards to remove.

Inserting the ashtray

- Push the ashtray down.

WARNING

Never put flammable materials in the ashtray. Risk of fire!

CAUTION

Never hold onto the ashtray by the lid when removing it. Risk of breaking the lid.

Power sockets



Fig. 154 Centre console: 12 V power socket.

12 volt socket

The 12 V power socket is located at the front of the centre console »» **Fig. 154**.

Using the power socket:

- Open the cover or remove the cigarette lighter concealing the socket.
- Insert the plug of the electrical appliance into the socket.

5 V power sockets (USB)*

The 5 V power sockets are located at the rear of the console, between the front seats, facing the rear seat occupants.

They are USB ports to which only devices and accessories that use this type of charging can be connected.

They are not intended for file playback.

The maximum power of these sockets is 2 A.

⚠ WARNING

- Improper use of the sockets or electrical appliances can cause a fire and lead to burns and other serious injuries.
- Never leave children unsupervised in the vehicle. The 12 V power socket is also functional when the ignition is switched off and the key is removed.
- Should the connected appliance overheat, immediately switch it off and disconnect it from the socket.

ⓘ CAUTION

- The 12 V power socket can only be used to power appliances with a power rating of up to 120 watts.
- Never exceed the maximum permitted power, as this could cause damage to the vehicle electrical installation.

- With the engine switched off, however, the vehicle battery will drain. Risk of discharging the battery!

- Only use suitable plugs so as not to damage the power socket.

- Only use appliances that have been tested for electromagnetic compatibility in compliance with current regulations.

- Before switching the ignition on or off, unplug the appliances from the power socket to protect them from any damage caused by fluctuations in voltage.

- Follow the instructions for use of connected appliances!

Multimedia compartment



Fig. 155 Front centre console: multimedia compartment.

The multimedia compartment is in the storage compartment of the front centre console »» **Fig. 155**.

The compartment can be used to hold mobile phones, mp3 players or similar devices.

⚠ WARNING

Never use the multimedia compartment as an ashtray or to store flammable materials. Risk of fire!

Storage compartment for glasses*



Fig. 156 Close-up of roof panel: storage compartment for glasses.

– Press the compartment lid and it will drop down »» **Fig. 156**.

⚠ WARNING

This compartment must only remain open when removing or replacing glasses. »»

ⓘ CAUTION

- Do not place heat-sensitive objects in the compartment as they could be damaged.
- The side compartment supports a maximum load of 0.25 kg.

Coat hooks*

The coat hooks are located on the B-pillars and on the handles on the interior lining above each rear door.

⚠ WARNING

- Make sure that any items of clothing hanging from the coat hooks do not obstruct your view to the rear.
- Only use the coat hooks for light items of clothing and make sure that there are no heavy or sharp objects in the pockets.
- Do not use clothes hangers to hang up the clothing, as this could interfere with the function of the head-protection airbags.

ⓘ CAUTION

The side hooks support a maximum load of 2 kg.

Compartments in the centre console

Fig. 157 Centre console: storage compartment.

Open storage compartment in centre console » **Fig. 157**.

Storage compartment in front door

Fig. 158 Storage compartment in door trim.

There is a bottle carrier in part **(B)** » **Fig. 158** of the storage compartment in the front door.

⚠ WARNING

Only use part **(A)** » **Fig. 158** of the compartment in the front door to store objects that do not protrude from it so as not obstruct the deployment area of the side airbags.

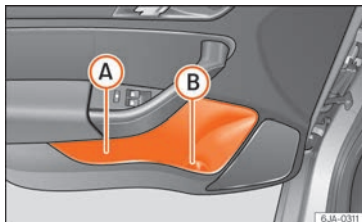
Storage compartment in the luggage compartment*

Fig. 159 Boot: storage compartment.

The lid from the side storage compartment can be removed to increase the size of the boot.

- Hold onto the top of the lid and pull it out in the direction indicated by the arrow » **Fig. 159**.

ⓘ CAUTION

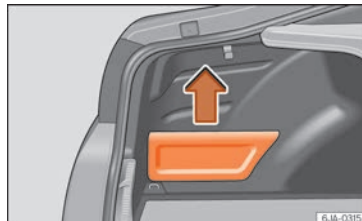
- The compartments are designed to hold small objects with a total weight of 1.5 kg.
- Make sure you do not damage the storage compartment or the boot trim when using the compartment.

Storing objects

Loading the luggage compartment

All luggage and other loose objects must be safely secured in the luggage compartment.

Unsecured objects which shift back and forth could impair the driving safety or driving characteristics of the vehicle by shifting the centre of gravity.

- Distribute the load evenly in the luggage compartment.
- Place heavy objects as far forward as possible in the luggage compartment.
- Place the heavy objects first.
- Secure heavy objects to the fitted fastening rings » page 141.

⚠ WARNING

- Loose luggage and other objects in the luggage compartment could cause serious injuries.

- Always stow objects in the luggage compartment and secure them on the fastening rings.

- Use suitable straps to secure heavy objects.

- During sudden manoeuvres or accidents, loose objects can be thrown forward, injuring vehicle occupants or passers-by. This increased risk of injury will be further increased if a loose object is struck by an inflating airbag. If this happens, objects may shoot outward like a missile. Risk of fatal injury.

- Please note that the centre of gravity may shift when transporting heavy objects; this may affect vehicle handling and lead to an accident. Therefore, it is essential to adjust your speed and driving style accordingly, to avoid accidents.

- Never exceed the allowed axle weights or allowed maximum weight. If said weights are exceeded, the driving characteristics of the vehicle may change, leading to accidents, injuries and damage to the vehicle.

- Never leave your vehicle unattended, especially when the rear lid is open. Children could climb into the luggage compartment, closing the door behind them; they will be trapped and run the risk of death.

- Never allow children to play in or around the vehicle. Close and lock all the doors and the rear lid when you leave the vehicle. Before you lock the vehicle, make sure that

there are no adults or children in the vehicle.

ⓘ Note

- Air circulation in the vehicle helps reduce fogging of the windows. Used air escapes through ventilation slits in the side trim of the luggage compartment. Ensure that the ventilation slots are never covered.

- Straps for securing the load to the fastening rings are commercially available from accessory shops.

Fastening rings*

There can be four fastening rings in the luggage compartment for fastening luggage and other objects.

- Always use suitable and undamaged straps to secure luggage and other objects to the fastening rings » ⚠ in Loading the luggage compartment on page 141.
- Pull up the fastening rings to attach the straps.

During a collision or an accident, even small and light objects can build up so much energy that they can cause very severe injuries. The amount of kinetic “energy” depends on the speed of the vehicle and the weight of the »

object. The most significant factor, however, is the speed of the vehicle.

Example: An object weighing 4.5 kg is lying unsecured in the vehicle. During a frontal collision at a speed of 50 km/h (31 mph), this object generates a force corresponding to 20 times its weight. That means that the effective weight of the object increases to approximately 90 kg. You can imagine the severity of the injuries which might be sustained if this "object" strikes an occupant as it flies through the interior of the vehicle. This increased risk of injury will be further increased if a loose object is struck by an inflating airbag.

WARNING

- If pieces of baggage or other objects are secured to the fastening rings with inappropriate or damaged retaining cords, injuries could result in the event of braking manoeuvres or accidents.
- Never secure a child seat on the fastening rings.

Luggage compartment

Introduction

Please observe the following points to ensure the vehicle handles well at all times:

- Distribute the load as evenly as possible.

- Place heavy objects as far forward in the luggage compartment as possible.
- Secure luggage using the fastening rings or retaining net »» page 143.

During an accident, even small and light objects can have so much kinetic energy that they can cause very severe injuries. The amount of kinetic energy depends on the speed of the vehicle and the weight of the object. However, the speed of the vehicle is the most important factor.

Example: an unsecured object weighing 4.5 kg produces energy corresponding to 20 times its weight in a frontal collision at 50 km/h (31 mph). This means that its weight reaches around 90 kg. You can imagine the severity of the injuries that might be sustained if this "projectile" strikes an occupant as it flies through the vehicle interior.

WARNING

- Store objects in the luggage compartment and secure to the fastening points.
- In an accident or sudden manoeuvre, loose objects in the interior can be flung forward and possibly injure vehicle occupants or others. This risk is even greater if the flying objects hit a triggering airbag. In this case, any rebounding objects could injure vehicle occupants. Risk of fatal injuries!

- Take into account that transporting heavy objects changes the centre of gravity that could also cause changes in vehicle handling. Risk of accident! Therefore, always adjust your speed and driving style to suit these circumstances.

- Securing the load to the rings using unsuitable or damaged straps could lead to injuries in the event of an accident or sudden braking manoeuvre. Secure suitable straps safely to the rings to ensure this does not happen.

- Position the load so it cannot move forward during a sudden braking manoeuvre. Risk of injuries!

- If transporting sharp or dangerous objects in the space provided when the rear seats are folded, ensure the safety of the occupant of the remaining rear seat »» page 60.

- If the rear seat located alongside a folded seat is occupied, ensure safety, for example, by placing the load so that it stops the seat from folding backward in the event of being hit from behind.

- Never drive with the rear lid open or half-closed, exhaust gases may penetrate into the interior of the vehicle. Danger of poisoning!

- Never exceed the allowed axle loads or allowed maximum weight. Risk of accident!

- Never transport passengers in the luggage compartment!

⚠ CAUTION

Make sure sharp objects stored in the boot cannot not damage the rear window heating filaments.

i Note

Tyre pressure must be adapted to suit the load » page 256, Service life of tyres.

Category N1 vehicles

Category N1 vehicles with no protection grille must use a retaining set compliant with Standard EN 12195 (1 – 4) to secure the load.

Retaining elements*

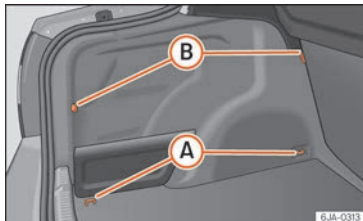

Fig. 160 Boot: retaining elements.

The following retaining elements are fitted in the boot » **Fig. 160**:

- A** Rings to secure the load and the retaining nets.
- B** Rings used solely for the retaining nets.

⚠ CAUTION

The rings support a maximum load of 3.5 kN (350 kg).

i Note

The front ring **B** is below the folding backrest of the rear seats » **Fig. 160**.

Hook*

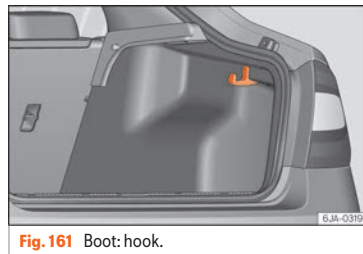

Fig. 161 Boot: hook.

There are hooks on both sides of the boot to secure light items of luggage such as bags, etc. » **Fig. 161**

⚠ CAUTION

The side hooks support a maximum load of 7.5 kg.

Retaining nets*

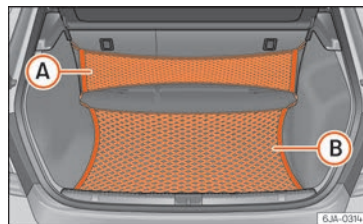

Fig. 162 Retaining nets.

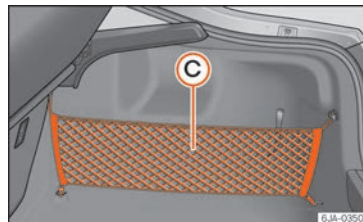

Fig. 163 Retaining nets.

Example of securing retaining nets » **Fig. 162** and » **Fig. 163**.

- A Sideways bag
- B Ground net
- C Lengthways bag

⚠ WARNING

Do not exceed the maximum load that the nets can support. Heavy objects cannot be safely secured. Risk of injury!

ⓘ CAUTION

- The retaining nets support a maximum load of 1.5 kg.
- Do not place any item with sharp edges in the net. Risk of damaging the net!

Luggage compartment shelf



Fig. 164 Remove the shelf.

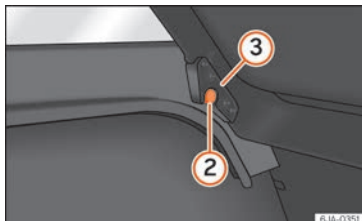

Fig. 165 Remove the shelf.

The shelf can be removed if a large load is to be transported.

Removing the shelf

- Remove the straps from the shelf ①
»» Fig. 164.
- Remove the shelf from its housing ② by knocking it gently from underneath between the supports.

Fitting the shelf

- Place the shelf on the side supports on the trim.
- Adjust the shelf supports ③ »» Fig. 165 to fit the supports ② in the trim.
- Fit into place by knocking the top of the shelf gently between the supports.
- Attach the straps ① to the tray.

⚠ WARNING

Do not place objects on the rear shelf that could endanger the vehicle occupants in case of a sudden braking manoeuvre or an accident.

ⓘ CAUTION

- The rear shelf supports a maximum load of 1 kg.
- If handled incorrectly, the rear shelf could bend when closing the rear lid, and become damaged or damage the trim. Follow the instructions below:
 - The shelf supports ③ »» Fig. 165 must be securely in place in the trim supports ②.
 - The size of the load must not exceed the height of the shelf.
 - When open, the shelf must not be bent against the shelf seal.
 - There must be no objects in the space between the open shelf and the backrest of the rear seat.

ⓘ Note

The shelf will lift when the rear lid is opened.

Roof rack*

Introduction

⚠ WARNING

- The load on the roof carrier must be properly secured. Risk of accident!
- Always secure the load using retaining straps that are in good condition.
- Distribute the load evenly.
- When transporting heavy or large objects on the roof, any change in normal vehicle behaviour due to a change in the centre of gravity or increased wind resistance must be taken into account. Risk of accident! For this reason, speed and driving style must be adjusted for the situation.
- Avoid sudden manoeuvres and braking.
- Adjust your driving style to suit visibility, the weather and road and traffic conditions.
- Never exceed the allowed axle loads or allowed maximum weight. Risk of accident!

ⓘ CAUTION

- Only use SEAT-authorized roof carriers.
- Where roof carriers from other systems are used or where they are not fitted properly, any damage caused to the vehicle will not be covered by the warranty. Therefore,

carefully follow the Instruction Manual for installation of the roof carrier.

- Remember that the rear lid must not hit the roof load.
- The total height of the vehicle increases according to the roof load. Compare the height of the vehicle with the heights of bridges or other underpasses, for example, the height of the garage door.
- Do not forget to remove the roof carrier before entering an automatic carwash.
- Take into account that the load must not damage the aerial located on the roof.

♻ For the sake of the environment

If aerodynamic resistance increases, fuel consumption will also increase.

Attachment points

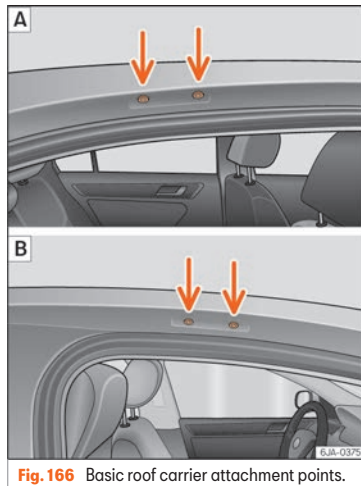

Fig. 166 Basic roof carrier attachment points.

Location of the basic roof carrier attachment points » **Fig. 166:**

- Ⓐ Rear attachment points
- Ⓑ Front attachment points

Install and remove following the instructions given. »

ⓘ CAUTION

Follow the instructions given in the manual.

Roof load

The maximum permissible roof load (including the support system) of **75 kg** and the total authorised weight of the vehicle must not be exceeded.

It will not be possible to carry the full maximum load if the roof carrier you are using is rated for a load which is less than this figure. In this case, you can only load the roof carrier to the maximum load permitted in your installation manual.

Air conditioning**Heating and air conditioning****General notes**

The power of the heating depends on the temperature of the coolant. Therefore, maximum power is only obtained when the engine has reached operating temperature.

The temperature and humidity of the air inside the vehicle decrease when the cooling system is turned on. This therefore increases the comfort of all vehicle occupants when outside temperatures and humidity are high. It also helps prevent the windows from misting over during cold periods of the year.

The air recirculation system can be switched on temporarily to increase the cooling effect.

Keep the air intake slots in front of the windscreen clear of ice, snow or leaves to ensure unimpaired heating and cooling.

When the air conditioning is on, **condensation** can drip from the evaporator in the air cooling system and form a pool underneath the vehicle. This is normal and does not indicate a leak!

⚠ WARNING

- All windows must be clear of ice, snow and condensation for driving safety. There-

fore, make sure you familiarise yourself with the correct use of heating and ventilation, window demisting and defrosting and cooling.

- Never use the air recirculation system for too long, as it prevents fresh air from entering the vehicle and used air can cause tiredness, reduce your attention span and cause the windows to mist over. This increases the risk of an accident. Switch off the air recirculation system as soon as the windows begin to mist over.

⚠ WARNING

Do not switch off Climatronic for longer than necessary.

- Switch Climatronic back on as soon as the windows begin to mist over.

ⓘ Note

- Used air escapes through ventilation slots in the rear of the luggage compartment.
- Smoking is not recommended while the air recirculation system is in use, as the smoke drawn from the interior of the vehicle settles in the evaporator of the air conditioning system. This causes a persistent, unpleasant smell while the system is running that is time-consuming and expensive (evaporator replacement) to eliminate.

- To guarantee proper operation, never cover the air outlets in the luggage compartment.

Economic use of the air-conditioning system

When the air conditioning is switched on, the compressor consumes engine power and has influence on fuel consumption.

If the vehicle interior has overheated due to excessive solar radiation, it is best to open the windows or doors to allow the hot air to escape.

While in motion, the air conditioning should not be switched on if the windows are open.

If the interior temperature can be reached without switching on the air conditioning, the fresh air mode should be used.



For the sake of the environment

Saving fuel reduces emissions.

Faults

If the air conditioning does not work at outside temperatures above +5°C (+41°F) then

the system is faulty. This may be due to one of the following reasons:

- One of the fuses has blown. Check the fuse and replace if necessary »» page 83.
- The air conditioning compressor has switched off temporarily because of increased engine coolant temperature »» page 101.

If you cannot repair the fault yourself or where cooling power continues to drop, switch off the system. Contact a specialised service.

Air vents



Fig. 167 Air vents.



Opening air vents 3 and 4

- Turn the vertical circular control upwards.

Closing air vents 3 and 4

- Turn the vertical circular control downwards.

Changing the direction of air delivery from air vents 3 and 4

- The air circulation height can be varied by changing the position of the sliding adjuster upwards or downwards »» Fig. 167.
- The air circulation direction can be varied by changing the position of the sliding adjuster to the right or to the left.

The flow of air from the vents is controlled using control **C** »» Fig. 168. Vents **3** »» Fig. 167 and **4** can be opened and closed individually.

Depending on the position of the adjusters and on the weather, open vents can provide air which is either heated, unheated or cooled.

Heating and fresh air

Operation



Fig. 168 Heating: controls.

Read the additional information carefully »» page 39

Temperature selection

- Turn rotary control **A** »» Fig. 168 clockwise to increase the temperature.
- Turn rotary control **A** anti-clockwise to reduce the temperature.

Blower selection

- Turn rotary control **B** »» Fig. 168 to position 1 to 4 to switch the blower on.
- Turn rotary control **B** to position 0 to switch the blower off.

- Press button **1** »» in Air recirculation on page 149 to close the fresh air vent.

Air distribution selection

- Turn rotary control **C** »» Fig. 168 to select the air vents »» page 147, Air vents you wish to activate.

All controls, except control **B** »» Fig. 168, can be set to any intermediate position.

Leave the blower activated at all times to prevent the windows from misting over.

Note

If the system is set so that all of the air is used to defrost the windows, no air is supplied to the footwell area. This could limit heating comfort.

Air recirculation

Air recirculation prevents unpleasant smells, e.g. when passing through a tunnel or in queuing traffic, from entering the interior.

If the rotary switch **C** »» Fig. 168 is in the thaw position, the recirculation flap will always be open (button light off).

If the rotary switch **C** is switched from any position to the thaw position, recirculation will be automatically deactivated.

Connecting the recirculation

In any position of rotary switch **C** except thaw:

- Press button **1** » **Fig. 168**, the switch's lamp will light up, indicating that air recirculation inside the vehicle has been activated.

Disconnecting the recirculation

In any position of rotary switch **C** except thaw:

- Press button **1** again and the button's lamp will go off, indicating that air recirculation from the outside has been activated.

In the thaw position of rotary switch **C**, the entry of air into the vehicle interior is always from the outside.

⚠ WARNING

Read and observe the safety warnings » ⚠ in General notes on page 146.

Air conditioning (manual)*

Manual operation



Fig. 169 Air conditioning: controls.

Read the additional information carefully » page 38

The air cooling system only works if button **A/C** **2** » **Fig. 169** is pressed and under the following conditions:

- The engine is running,
- The outside temperature is above +2°C (+36°F),
- The blower control is in position 1–4.

When the cooling system is on and under certain conditions, air can be blown from the vents at a temperature of approximately +5°C (+41°F). In the event of prolonged, irregular distribution of the air flow from the outlets and significant differences in temperature,

e.g. on leaving the vehicle, sensitive people may catch cold.

Temperature selection

- Turn rotary control **A** » **Fig. 169** clockwise to increase the temperature.
- Turn rotary control **A** anti-clockwise to reduce the temperature.

Blower selection

- Turn rotary control **B** » **Fig. 169** to position 1 to 4 to switch the blower on.
- Turn rotary control **B** to position 0 to switch the blower off.
- Press button **1** » **page 150**, Air recirculation to close the fresh air vent.

Air distribution selection

- Turn rotary control **C** » **Fig. 169** to select the air vents » **page 147** you wish to activate.

Switching cooling on and off

- Press button **A/C** **2** » **Fig. 169** and the lamp in the button will illuminate.
- Press button **A/C** **2** again and the light in the button will switch off.

»

Coldest setting

- On turning the control **A** to the coldest setting (blue indicator), buttons **1** and **2** **A/C** light up.
- The recirculation function is activated automatically in order to cool faster.

i Note

- A visit to the specialised service once a year is recommended to clean the air conditioning system.
- If the air distribution is directed towards the windows, all of the heating power is used to defrost the windscreen. No warm air is directed to the footwell area. This could limit heating comfort.
- The AC button lamp **A/C** will illuminate after the system has been switched on, even if not all of the cooling system's operating conditions are met. Cooling is indicated as

available once all of the conditions are met »» page 149, Manual operation.

Air recirculation

Air recirculation prevents unpleasant smells, e.g. when passing through a tunnel or in queuing traffic, from entering the interior.

If the rotary switch **C** »» Fig. 169 is in the thaw position, the recirculation flap will always be open (button light off).

If the rotary switch **C** is switched from any position to the thaw position, recirculation will be automatically deactivated.

Connecting the recirculation

In any position of rotary switch **C** except thaw:

- Press button **1** »» Fig. 169, the switch's lamp will light up, indicating that air recirculation inside the vehicle has been activated.

Disconnecting the recirculation

In any position of rotary switch **C** except thaw:

- Press button **1** again and the button's lamp will go off, indicating that air recirculation from the outside has been activated.

In the thaw position of rotary switch **C**, the entry of air into the vehicle interior is always from the outside.

⚠ WARNING

Read and observe the safety warnings »» **⚠** in General notes on page 146.

Climatronic* (automatic air conditioning)

General notes

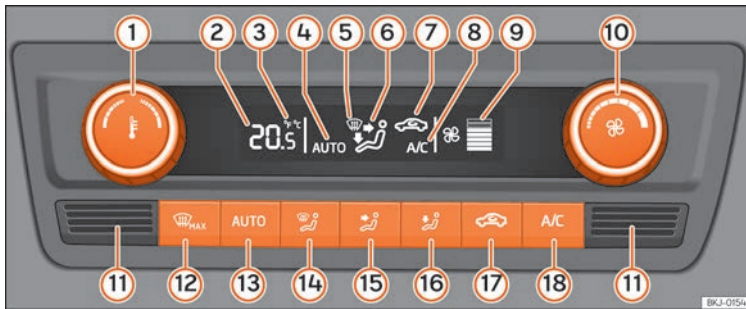

Fig. 170 Climatronic: controls.

Read the additional information carefully
»» page 37

Climatronic automatically maintains a comfortable temperature. To do so, it automatically regulates the supplied air temperature and the blower and air distribution levels. The system also allows for the effect of sunlight, so there is no need for manual adjustment. It also has a humidity sensor that helps to automatically demist the windscreen.

Automatic operations »» page 152 guarantee maximum comfort any time of year.

Climatronic description

Cooling only works if the following conditions are met:

- The engine is running
- the outside temperature is above +2°C (+36°F);
- **A/C** »» Fig. 170 (18) turned on.

Starting the Climatronic

The corresponding function will be switched on when a button is pressed, turning on the air conditioning if it was switched off, with the exception of button (17) (recirculation).

Switching off the Climatronic

- Turn control (10) to the left until the segments of column (9) »» Fig. 170 switch off.
- After **1 second** has elapsed, turn the control again to switch off the display.

In order to ensure engines subject to heavy loads are cooled, the air conditioning compressor is switched off in the event of high coolant temperatures.

Recommended setting for all seasons of the year

- Set the required temperature. We recommend +22°C [+72°F].



- Press the button **AUTO**  »» **Fig. 170**.
- Adjust vents **3** and **4** »» **page 147** so that the air flow is directed slightly upwards.

Change between degrees Centigrade and degrees Fahrenheit

Keep the **AUTO** and **A/C** »» **Fig. 170** buttons held down for **2 seconds** at the same time. The data is displayed on the screen in the units required.

Note

- **A visit to the specialised service once a year is recommended to clean the Climatronic system.**
- **The interior temperature sensor  »» **Fig. 170** is at the bottom. Do not cover it with stickers or the like, as this could have a negative effect on Climatronic operations.**

Automatic mode

Automatic mode is used to maintain a constant temperature and demist the windows inside the vehicle.

Switching on automatic mode

- Set a interior temperature between +16°C [+64°F] and +29°C [+84°F].
- Adjust vents **3** »» **page 147** and **4** so that the air flow is directed slightly upwards.

- Press the button **AUTO**  »» **Fig. 170**, and **AUTO** is displayed on the screen.

Automatic mode is switched off by pressing the air distribution buttons or increasing or decreasing the blower speed. However, the temperature remains regulated.

Adjusting the temperature

- When you switch on the ignition, control  »» **Fig. 170** can be used to set the required interior temperature.

It is possible to select interior temperatures from +16°C [+64°F] to +29°C [+84°F]. In this range the temperature is regulated automatically. If a temperature below +16°C [+64°F] is selected, "LO" is displayed on the screen. If a temperature above +29°C [+84°F] is selected, "HI" is displayed on the screen. At both extremes, Climatronic works at maximum cooling or heating power, respectively. The temperature is not regulated.

In the event of prolonged, irregular distribution of the air flow from the outlets (particularly the footwells) and significant differences in temperature, e.g. on leaving the vehicle, sensitive people may catch cold.

Air recirculation

Air recirculation prevents unpleasant smells, e.g. when passing through a tunnel or in queuing traffic, from entering the interior.

Switching on air recirculation mode

- Press the button   »» **Fig. 170** and the  symbol is displayed on the screen.

Switching off air recirculation mode

- Press the button   »» **Fig. 170** and the  symbol disappears from the screen.

WARNING

Read and observe the safety warnings »» 
in General notes on page 146.

Note

If air recirculation mode remains on for 15 minutes, the  symbol will start to flash on the screen to indicate prolonged air recirculation. If air recirculation is not switched off, the symbol will continue to flash for about 5 minutes.

Blower selection

Climatronic automatically regulates blower speed according to the interior temperature.

It is possible, however, to set the blower speed to suit requirements.

- Turn control **10** »» Fig. 170 counter-clockwise (to lower the speed) or clockwise (to increase the speed).

Climatronic will switch off when the blower switches off.

WARNING

Read and observe the safety warnings »» 
in General notes on page 146.

Windscreen defrost

Switching on windscreen defrosting

- Press the button  **MAX 12** »» Fig. 170.

Switching off windscreen defrosting

- Press the button  **MAX 12** »» Fig. 170 several times or press the **AUTO** button.

The temperature is regulated automatically.
The air output is increased from vents 1
»» page 147 and 2.

Infotainment System

Introduction

Safety warnings

Infotainment system safety instructions

Travelling on today's roads requires the driver's full attention at all times.

Only operate the infotainment system and its various functions when the traffic situation really permits this.

WARNING

- Before starting the trip, you should familiarise yourself with the different infotainment system functions.
- High audio volume may represent a danger to you and to others.
- Adjust the volume in a way that you can distinguish surrounding noise, for example, horns and sirens, etc.
- Changes to the Infotainment system settings should be made when the car is stopped, or by a passenger.

WARNING

Distracting the driver in any way can lead to an accident and cause injuries. Operating the Infotainment system can distract your attention from the traffic.

- Always drive carefully and responsibly.
- Select volume settings that allow you to easily hear signals from outside the vehicle at all times (e.g. emergency services sirens and horns).
- Hearing may be impaired if using too high a volume setting, even if only for short periods of time.

WARNING

The volume level may suddenly change when you switch audio source or connect a new audio source.

- Lower the base volume before connecting or switching audio sources.

WARNING

The driving recommendations and traffic indications shown on the navigation system may differ from the current traffic situation.

- Traffic signs and traffic regulations have priority over the recommendations and displays provided by the navigation system.
- Adjust your vehicle speed and driving style to suit visibility, weather, road and traffic conditions.

WARNING

Connecting, inserting or removing a data medium while driving can distract your attention from the traffic and cause an accident.

WARNING

Connecting leads for external devices may obstruct the driver.

- Arrange the connecting leads so that they do not obstruct the driver.

WARNING

External devices that are loose or not properly secured could move around the passenger compartment during a sudden driving or braking manoeuvre or an accident and cause damage or injury.

- Never place or fit external devices to the doors, windscreen, steering wheel, dash panel, the backs of the seats, on top of or near the area marked "AIRBAG" or between these areas and the occupants. External devices can cause serious injury in an accident, especially when the airbags inflate.

WARNING

The armrest may obstruct the driver's arm movements, which could cause an accident and severe injuries.

- Always keep the armrest closed while the vehicle is in motion.

WARNING

Opening a CD player's housing can lead to injuries from invisible laser radiation.

- Have CD players repaired only by a qualified workshop.

CAUTION

The Infotainment system can be damaged by the incorrect insertion of a data storage device or the insertion of an incompatible data storage device.

- When inserting a data storage device, make sure it is correctly positioned.
- Applying force may irreparably damage the memory card slot locking mechanism.
- Only use compatible memory cards.
- When inserting and removing CDs, always hold them at right angles to the front of the CD drive without tilting so as not to scratch them.
- If a CD is inserted while another is already in the unit or being ejected, the CD drive may be irreparably damaged. Always wait until the data medium is completely ejected.

CAUTION

Any foreign objects stuck to a data storage device and non-round media may damage the CD player.

- Only clean, standard 12-cm CDs should be used.
 - Do not affix stickers or other items to the data medium. Stickers may peel off and damage the drive.
 - Do not use printable data media. Printed labels and coverings may peel off and damage the CD drive.
 - Do not insert 8-cm “single” CDs or irregularly shaped CDs.
 - Do not insert DVD-Plus discs, Dual Discs or Flip Discs, as these are thicker than normal CDs.

CAUTION

The vehicle loudspeakers may be damaged if the volume is too high or the sound is distorted.

Note

For the proper functioning of the Infotainment system it is important that the date and time set in the vehicle are correct.

Overview of the unit

Media System Touch / Media System Colour

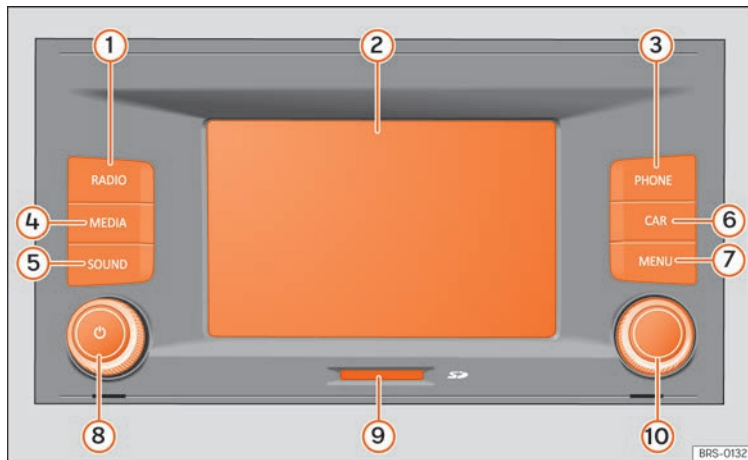



Fig. 171 Overview of the controls (this configuration depends on the version).

- | | | |
|--|---|---|
| ① Radio Mode (change of band frequency)
»» page 171 | ⑤ Volume and sound settings | ⑩ Settings button (search and selection)
»» page 158 |
| ② Touchscreen »» page 159 | ⑥ Vehicle settings »»  page 24,
»» page 188 | |
| ③ Telephone mode* / TP Settings
»» page 189 | ⑦ Selecting the main menu »» page 158 | |
| ④ Media mode (audio sources)
»» page 172 | ⑧ Volume. Off/on »» page 158 | |
| | ⑨ Slot for memory cards »» page 175 | |

Media System Plus / Navi System

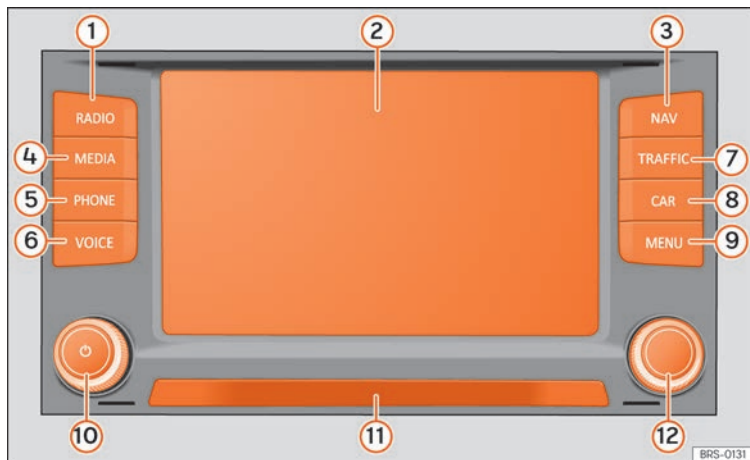

Fig. 172 Overview of the controls [this configuration depends on the version].

- ① Radio Mode [change of band frequency] »»» page 171
- ② Touchscreen »»» page 159
- ③ Navigation Mode »»» page 178
- ④ Media mode [audio sources] »»» page 172
- ⑤ Phone Mode »»» page 189
- ⑥ Voice control
- ⑦ Full Link »»» page 163
- ⑧ Vehicle settings »»» page 24, »»» page 188
- ⑨ Selecting the main menu »»» page 158
- ⑩ Volume. Off/on »»» page 158
- ⑪ Proximity sensor »»» page 162
- ⑫ Settings button [search and selection] »»» page 158

General instructions for use

Introduction



Fig. 173 Related video

If the setup is changed, this may change the display on the screen and in some cases, the Infotainment system may behave in a manner different to that described in this manual.

Note

- Lightly pressing the buttons or briefly pressing the touchscreen is sufficient to operate the Infotainment system.
- Not all listed function buttons and functions described may be available due to the device software used in your market. The equipment is not faulty if a function button is missing from the screen.
- Due to country-specific legislation, certain functions may not be available on the screen when the vehicle is travelling above a certain speed.
- Using a mobile telephone in the vehicle may cause noise from the vehicle loudspeakers.

- Restrictions on the use of devices using Bluetooth® technology may apply in some countries. For further information, contact the local authorities.
- On some vehicles with ParkPilot, the volume of the audio source is automatically lowered when reverse gear is selected. The volume can be lowered in the menu Sound > Volume.

Diagram of the menus

The Infotainment system touchscreen can be used to select the different main menus.

Press the Infotainment button **MENU** to open the menus summary.

The display of the touchscreen's main menu can be switched between "grid" and "carousel" via the **Settings > Display** menu.

Infotainment rotary/push knobs

Rotary/push knobs

The left-hand rotary knob is the volume control or the on/off button.

The right-hand rotary knob is the setup button.

Infotainment buttons

The buttons on the unit are shown in this manual with the word "infotainment button" and their function within a rectangle, for example, the infotainment button **MENU**.

The Infotainment buttons are used by *pressing them or pressing and holding*.

Switching on and off

To manually switch the Infotainment system on and off, briefly press the left rotary knob .

When switching on, the system starts-up with the last set volume, provided that this does not exceed the preset maximum start-up volume. Select **Sound > Volume**.

The unit will switch off automatically when the key is removed from the ignition or when the on/off button is pressed (depending on the equipment fitted or the vehicle). If the Infotainment system is switched on again, it will switch off automatically after approximately 30 minutes (switch-off delay).

Note

- The Infotainment system is a part of the vehicle. It cannot be used in any other vehicle.
- If the battery has been disconnected, the ignition must be activated before switching on the Infotainment system.

Changing the basic volume

Increasing or decreasing the volume or muting the sound

Raise the volume: turn the volume control ⏻ clockwise or move the left thumbwheel on the multifunction steering wheel upward ▲.

Lower the volume: turn the volume control ⏻ clockwise or move the left thumbwheel on the multifunction steering wheel downward ▼.

Changes in volume are indicated by a volume bar on the screen. The volume can be controlled using the steering wheel controls. In this case, the changes in volume are displayed on the instrument panel by a volume bar.

It is possible to preset certain volume settings and adjustments. Select **Sound > Volume**.

Muting the Infotainment system sound

- Turn the volume control ⏻ anti-clockwise until it displays 🔕.

Muting the Infotainment system sound stops the media source that is playing. The screen displays 🔕.

i Note

If the base volume has been considerably increased to play a certain audio source,

lower the volume again before switching to another audio source.

Handling the function buttons and display instructions

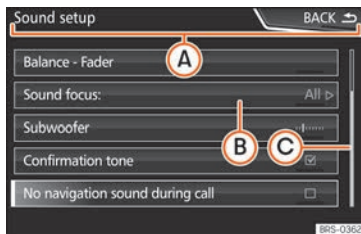

Fig. 174 View of some of the function buttons on the screen.

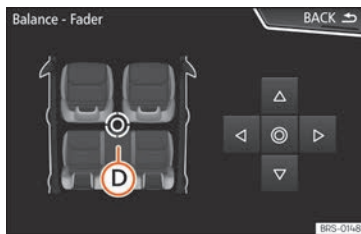

Fig. 175 Sound setup menu

The Infotainment system comes equipped with a touchscreen.

Active areas of the screen that call up a certain function are called "function buttons". These buttons are operated by *briefly pressing* the screen or by *pressing and holding*.

The function buttons appear in the instructions with the label "function button" and a button symbol inside a rectangle.

Function buttons start functions or open sub-menus. The currently selected menu is displayed in the title bar **»»»** **Fig. 174** **A** of the submenus.



Inactive (grey) function buttons cannot be selected.

Increase or decrease the size of the images displayed on the screen



The size of the navigation map image **»»»** **page 178** and, for example, photos when viewing images **»»»** **page 172** can be enlarged or reduced. To do so, enlarge or reduce the image displayed by moving two fingers **»»**

Overview of screen and function buttons

Display and function buttons: operation and effect

A	The title bar shows the selected menu and, where applicable, other function buttons.
B	Press it to open another menu.
C	The scroll bar is shown on the right and its size depends on the entries in the list. Move the bar on the screen by pressing lightly and without lifting the finger, see >>> page 160, Opening list entries and searching in lists.
	Movable cursor: Move the cursor around the screen by pressing lightly and without lifting the finger.
	OR: To move the cursor to a particular position, press that spot on the screen.
D	Fixed crosshair: Press the up, down, left and right arrows to move the sound according to preference. The cursor D will move.
	OR: Press the central button to centre the stereo sound in the centre of the passenger compartment
	Press it on some lists to move up a level, one by one.
BACK 	Press to return from the submenus one at a time to the main menu or to undo the entries made.

Display and function buttons: operation and effect

	When pressed, a pop-up window opens (options window) which displays other setup options.
<input checked="" type="checkbox"/> / <input type="checkbox"/>	Some functions or messages are accompanied by a check box and are activated <input checked="" type="checkbox"/> or deactivated <input type="checkbox"/> by pressing said check box.
OK	Press to confirm an entry or a selection.
x	Press to close a pop-up window or an input window.
+ / -	Press them to change the setup adjustments one at a time.
	Move the slider around the screen by pressing it lightly and without lifting your finger.

Opening list entries and searching in lists

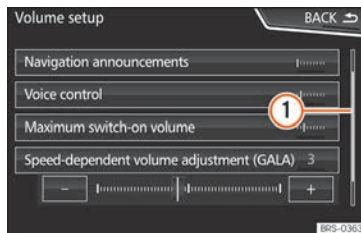
Fig. 176 Entries on a setup menu list.

The entries on a list can be activated by pressing them on the screen directly or by using the adjustment button.

Mark list entries using the setup button and open them

- Turn the setup button to mark the entries on the list with a rectangle one by one and continue searching the list in this manner.
- Press the setup button to activate the marked entry on the list.

Search lists (scrolling the screen)

The scroll bar is shown on the right and its size depends on the entries in the list

>>> Fig. 176 1.

- *Briefly press* the screen above or below the scroll marker.
- **OR:** Place a finger over the scroll marker and *without lifting it*, move it around the screen. Lift your finger off the screen when you reach the desired position.
- **OR:** Place your finger in the centre of the screen and *without lifting it*, move it around the screen. Lift your finger off the screen when you reach the desired position.

Input masks with on-screen keypad



Fig. 177 Input window with on-screen keypad.

Input windows with on-screen keypad are used for functions such as entering an entry name, selecting a destination address or entering a search term for searching long lists.

The function buttons listed below are not available in all countries or for all topics.

Subsequent chapters only explain those functions that differ from those in the screen shown in the figure.

The input line with cursor is located in the top bar of the screen. All inputs are displayed here.

Input windows for “free text input”

In the input masks for open text, you may enter letters, numbers and special characters in any combination.

Input windows for selecting a saved entry (e.g. selection of a destination address)

It is only possible to select a sequence of letters, numbers and special characters that matches a stored entry.

Suggestions for matching destinations appear depending on the characters entered in the input line » **Fig. 177** ④. In the case of compound names, it is necessary to enter a space.

If there are fewer than 99 selectable entries, the number of remaining entries is displayed after the input line ③. Pressing this function button displays these remaining entries in a list.

Overview of the function buttons

Function icon and text: operation and effect

Letters and digits	Press them to copy them into the input line.
①	<p>: Press this button to enter a zip code in the Navigation mode.</p> <p>: Press this button to open the number and special character input screen.</p> <p>: Press this button to go back to the letter input screen.</p>
②	Press to change the keypad to another language. Keypad languages can be selected from the menu System settings > Language .
③	Displays the number and opens the list of remaining selectable entries that match the entered text.
④	Hold and press to display a pop-up window with the special characters based on said letter. Press the desired character to enter it. Some special characters can be written out instead (e.g. “AE” for “Ä”).
	Press to enter a space.
	Press to delete characters in the input line from right to left.
	Press and hold to delete several characters.

»

Function icon and text: operation and effect

BACK  Press to close the input window.

^{a1} Depends on the market and unit in question.

Proximity sensors

✓ Valid for: Media System Plus/Nav System

The Infotainment system is equipped with an integrated proximity sensor **»» Fig. 172 (11)**.

The image on the screen changes from display mode to automatic operation when your hand moves toward it. In operation mode, the function buttons are automatically highlighted to facilitate their use.

Additional information and display options

The displays appearing on the screen may vary depending on the settings, and may differ from those described here.

The status bar on the screen can display, for example, the current time and outside temperature.

All displays can be viewed only after completely restarting the Infotainment system.

Initial configuration wizard



Fig. 178 Initial configuration wizard

The initial configuration wizard will help you to set up your Infotainment system the first time you switch it on.

Every time you switch on the Infotainment system, the initial setup screen will appear **»» Fig. 178** if any parameters have not been set or if the **NEVER** function button has not been pressed.

Function button: function

CLOSE

Closes the Configuration Wizard, and the main menu or last mode in which you used the Infotainment system will appear. The next time you switch on the system, the Configuration Wizard will start up again.

Function button: function

NEVER

Disables the possibility of changing the settings of the Infotainment system. If you want to perform the initial system setup, you must enter via **System setup** and select **Configuration Wizard**.

START

Starts up the Configuration Wizard.

A

Press to configure the time and date (if it has a navigation system it will be configured automatically with the GPS).

B

Press to search and store to memory the radio stations that have the best reception at that moment on all available bands (AM, FM and DAB).

C

Press to link your mobile telephone to the Infotainment system.

D^{a1}

Press to select your home address using your current position or by manually entering an address.

PREVIOUS

To go to the previous or next parameter to set.

NEXT

When a parameter has been set, the only way to reset it is from the main menu, clicking on it, and not using the Previous/Next buttons. When setting any parameter, a confirmation mark will appear on it .

Function button: function

FINISH

Once one or more settings have been applied, click on this in the main menu of the wizard to confirm and finalize the settings.
If there are any parameters you have not set, the next time you connect the Infotainment system, the Initial Configuration Wizard will start up.

^{a1} Only valid for Navi System.

Connectivity

Data transfer

This communication can allow data to be read and/or written.

From the SETTINGS menu > **Data transfer for SEAT apps**, there is a checkbox to activate/deactivate the function and a dropdown menu called **Operation via apps** which controls the level of interaction between the apps and the system.

Full Link*

Full Link technology description



Fig. 179 Related video

The Full Link system provides a way of bringing together technologies that allow communication between the Infotainment System and mobile devices:

- MirrorLink®

- Android Auto™
- Apple CarPlay™

Interfaces

To access the Full Link system, press the Infotainment button **(MENU)** (Full Link) and then select the **Full Link** context.

The connection to Full Link is made through a USB interface.

⚠ WARNING

If a mobile terminal is not secured or is incorrectly secured in the vehicle, it could move around the passenger compartment in the event of a sudden driving manoeuvre, emergency stop or accident, resulting in injury.

- While driving, mobile terminals must be securely fastened in position, outside the airbag deployment zones, or safely stowed away.

⚠ WARNING

Any applications that are not suitable or execute incorrectly may cause damage to the vehicle, accidents and serious injuries.

- SEAT recommends the use of the Apps that SEAT provides for this vehicle.
- To make full use of SEAT Apps, you must activate the option Setup, Data transfer for SEAT apps.

»

- The interaction level of the Apps on the system must be: ALLOW.
- Protect the mobile terminal with its applications from improper use.
- Never make modifications to the applications.
- Consult the instruction manual for the mobile terminal.

⚠ WARNING

The use of applications while driving can distract your attention from the traffic. Distracting the driver in any way can lead to an accident and cause injuries.

- Always drive carefully and responsibly.

ⓘ CAUTION

- In areas where special regulations apply or the use of mobile terminals is forbidden, the mobile terminal must be switched off at all times. The radiation produced by the mobile terminal when switched on may interfere with sensitive technical and medical equipment, possibly resulting in malfunction or damage to the equipment.
- SEAT cannot be held liable for any damage caused to the vehicle as a result of the use of applications that are of poor quality or are defective, the inadequate programming of the applications, the insufficient coverage of the network, the loss of data

during transmission or the improper use of mobile terminals.

ⓘ Note

- Use of Full Link technology may result in high consumption of your 3G/4G data plan.
- SEAT recommends having a high battery charge on the device when connected to Full Link.
- SEAT recommends that to use Full Link, the "Date and time" should be correctly configured. Select Settings > Date and Time.
- SEAT applications are designed to communicate with the vehicle and interact with it via the Full Link connection, therefore its functionality is linked to the mobile device being connected via USB.
- You can find further information on the technical requirements, compatible devices, suitable applications and availability at www.seat.com or at SEAT dealers.

Is Full Link blocked?

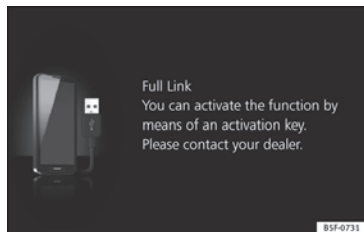

Fig. 180 Message on Infotainment system screen.

To unblock this feature, you must obtain the accessory from your SEAT dealer. Otherwise, a message like this will appear on the screen whenever you select the feature »» **Fig. 180**.

Requirements for Full Link

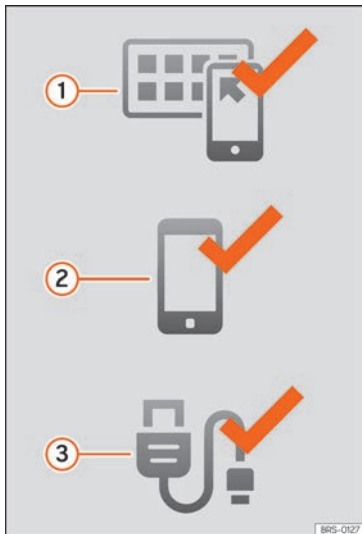

Fig. 181 Full Link Requirements

- ① **Full Link Activated:** If you do not have Full Link in your vehicle you can acquire it as an accessory at your Authorised Service.
- ② **Compatible Phones.** Go to the MirrorLink®, Android Auto™ or Apple CarPlay™

websites to confirm whether your phone is compatible with the system.

Mirror Link

- Check smartphone compatibility: www.mirrorlink.com/phones
- MirrorLink® 1.1 or higher
- Some of the Apps certified by SEAT or the CCC must be installed in the device.

Android Auto

- Check smartphone compatibility. Android Auto™: www.android.com/auto/
- Android 5.0 (Lollipop) or higher
- Install Android Auto™ app

Apple CarPlay

- Check smartphone compatibility. Apple CarPlay™: www.apple.com/ios/carplay
- iPhone 5 or higher and iOS 7.1 or higher
- Turn on the SIRI personal assistant (see phone settings)

- ③ **USB cable connecting car to phone:** use the USB cable approved and supplied by the phone's official distributor.

Activation of Full Link

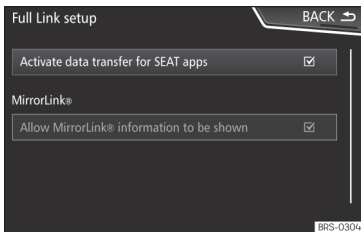

Fig. 182 Full Link Setup



Fig. 183 Full Link menu

Data connection via Wi-Fi or SIM is not necessary to establish the connection between the smartphone and Full Link.

Data connection via Wi-Fi or SIM is necessary to enable all of the app features¹⁾.

Proceed as follows to use Full Link:

- Switch on the Infotainment system
- Connect the smartphone to the vehicle's USB port using a USB cable »» page 195.
- In the main menu for the Full Link setup, select **Activate data transfer for SEAT apps** »» Fig. 182:

Finally, a message will appear stating that data transfer will commence when the device is connected. Please note that data is transferred over connections between your vehicle and mobile device. Press **OK**. Once selected, the technology compatible with your device can be used.

Note

Depending on your smartphone, it may have to be unlocked for the connection to occur.

What should I do if it does not connect?

Restart the mobile device

Check the USB cable visually.

Make sure that the USB cable is not damaged. Check that both connections (USB/micro USB) are not damaged or worn.

Visually check that the USB ports are properly connected.

Check that the vehicle and device USB connections are not damaged and/or worn.

Clean the USB ports (device and vehicle).

Try another compatible mobile device.

Have the USB port replaced at a SEAT Authorised Service.

Have the mobile device repaired or replace it.

Try another compatible mobile device.

¹⁾ Using the data connection to transfer the smartphone apps to Full Link may involve additional charges. Please check the charges with your operator.

Pairing of portable devices supporting the MirrorLink®, Android Auto™ and/or Apple CarPlay™ technologies



Fig. 184 Full Link menu

Carousel

When you enter the Full Link context for the first time, the technologies available for pairing the portable device are displayed.

Once the device connects via USB, the system will offer you the technologies available for establishing a connection with your mobile phone.

In the event of simultaneous connections between two devices with different operating

systems, a choice will be presented for which one to make the connection with »» **Fig. 184**.

View of the device list

iPhone™ devices only support Apple CarPlay™.

There are some Android devices that support MirrorLink® and Android Auto™.

Bear in mind that once the device is connected it will not be available as an audio source.

Full Link setup

Function button: function

Activating data transfers for SEAT applications allows the exchange of information between the vehicle and applications authorised by SEAT.

Last Mode

If a session using one technology ends without the disconnection being made from the Infotainment system (simply by disconnecting the cable) then when the device is next connected to it, the session will start without the user being required to take any action¹⁾.

Information

Consult the mobile device manual.

Depends on each technology:

1. Availability in a country
2. Third party applications

For further information:

MirrorLink®:

www.mirrorlink.com

Apple CarPlay™:

www.apple.com/ios/carplay

Android Auto™:

www.android.com/auto

Note

- In order to use Android Auto™ technology it is necessary to download the Android Auto™ application, located on Google Play™.
- Only compatible applications can be used, in accordance with the technology connected.

¹⁾ Unless the device requires the screen to be unlocked in order to establish the connection.

MirrorLink®



Fig. 185 Function buttons in the general view of compatible applications.



Fig. 186 Other MirrorLink function buttons.

MirrorLink® is a protocol which enables communication between a portable device and the Infotainment system via USB.

Using it makes it possible to display and manage the content and functions displayed on

the portable device on the Infotainment system screen.

To avoid distracting the driver while driving, only specially adapted applications can be used »» **▲** in **Full Link technology description on page 163**.

Requirements

In order to use MirrorLink®, the following requirements must be met:

- The mobile device must be compatible with MirrorLink®.
- The mobile device must be connected to the Infotainment system via USB.
- Depending on the mobile device used, a suitable application must be installed for the use of MirrorLink® on the device.

Initiating the connection

- In order to initiate the connection with the mobile device, it is simply necessary to connect it to the Infotainment system via the USB connection.
- A pop-up screen will appear, which will request that you accept the device.

Function buttons and possible messages

Function button: function

Full Link	To return to the Full Link main menu.
------------------	---------------------------------------

Function button: function

CLOSE APPS	Press to close the open apps. Then press the apps to be closed or the (Close all) function button to close all the open applications.
1 : 1	Press to change to the mobile device screen.
SETTINGS	To open the Full Link setup
»» Fig. 186 ①	Press to return to the MirrorLink® main menu.
»» Fig. 186 ②	Press to display all the function buttons in the lower or upper right-hand margin of the screen.
»» Fig. 186 ▲ / ▸	Allows buttons ① and ② to be hidden or shown.
»» Fig. 172 ⑫	

MirrorLink® setup

Function button: function

<input checked="" type="checkbox"/> Activate MirrorLink	pop-up windows: Allows MirrorLink® pop-up windows in applications that support it.
--	--

Apple CarPlay™*

✓ Valid for compatible iPhone™ mobile telephones. Also, iPhone™ mobile telephones only support Apple CarPlay™

Apple CarPlay™ is a protocol which enables communication between a mobile telephone and the Infotainment system via USB.

This makes it possible to display and operate the mobile telephone on the Infotainment system screen.

Requirements

In order to use Apple CarPlay™, the following requirements must be met:

- Make sure that you do not have Apple CarPlay™ restricted on your device, at: **Settings > General > Restrictions > CarPlay > ON.**
- The mobile device must be compatible with Apple CarPlay™.
- The mobile device must be connected to the Infotainment system via USB.

Initiating the connection

In order to initiate the connection with the mobile device, it is simply necessary to connect it to the Infotainment system via the USB connection.

- A pop-up screen will appear, which will request that you accept the device.

- If you start the session using Apple CarPlay™ technology, it will not be possible to pair another device via Bluetooth®. The following message will appear in the main *Phone* menu:

Please disconnect Apple CarPlay first, before you can connect another mobile telephone.

Holding down the Ω button will start the Apple™ voice “engine”.

To return to the basic contents of the Infotainment system, press the **SEAT** icon.

Android Auto™*

✓ Valid for compatible Android mobile phones.

Android Auto™ is a protocol which enables communication between a portable device and the Infotainment system via USB.

This makes it possible to display and operate the mobile telephone on the Infotainment system screen.

Requirements

In order to use Android Auto™, the following requirements must be met:

- The mobile device must be compatible with Android Auto™.

- The mobile device must be connected to the Infotainment system via USB.
- The Android Auto™ application should already be downloaded and installed on the mobile device.

Initiating the connection

In order to initiate the connection with the mobile device, it is simply necessary to connect it to the Infotainment system via the USB connection, and to be sure to follow the instructions of the device being paired.

- The first connection to Android Auto™ must be done while the vehicle is stationary.
- Once the first pop-up window about accepting data transfer between the car and the device has been accepted, a message will appear requesting that you check your mobile device for the confirmations needed to pair it with the Infotainment system.
- If you are initiating the session using Android Auto™ technology via USB, the mobile telephone connects automatically via Bluetooth® to the Infotainment system telephone and it will not be possible to pair another mobile telephone via Bluetooth®.

Holding down the Ω button will start the Android™ voice “engine”.

To return to the basic contents of the Infotainment system, press the **Return to SEAT** button.



i Note

Some mobile devices require a change in the USB connection mode in order to use Android Auto™.

- Make sure that your mobile is in "Media Transfer Protocol (MTP)" mode before it is connected by USB to the Infotainment system.

i Note

Android Auto™ requires the use of Google™ services, as well as certain basic applications of the Android system.

- Make sure that you always have Google™ services updated in order to use this technology.

Frequently asked questions about Full Link

What is the connection method?

USB Cable.

Will the USB cable be supplied with the vehicle?

No. The USB cable supplied with the device should be used.

Is there a navigation option?

Navigation is possible in each one of the Full Link technologies if the technology is available in your country and if you have the Navigation app.

What is the difference between using the Full Link system navigator (via telephone) instead of another navigator?

Benefits: Daily updates.

Issues: data consumption, reception problems.

Can I send voice messages?

With certified apps, you can answer but not send voice messages.

What apps are visible while driving?

Depending on the technology:

- for MirrorLink®: SEAT-certified apps and CCC,
- for Android Auto™: Apps selected by Google™,
- for Apple CarPlay™: Apps selected by Apple™.

Where can I find compatible apps?

Compatible apps can be found on the following links:
www.mirrorlink.com/
www.android.com/auto/
www.apple.com/ios/carplay/

Where can I download apps?

On Google Play™ for Android Auto™/MirrorLink® and on Apple Store™ for Apple CarPlay™.

If Full Link stops working, where can I have it repaired?

If the problem is in the car, you should go to the dealer. If the problem is in the mobile device, you should see your mobile telephone vendor.

Will WhatsApp be certified?

This depends on the technology.

Is MirrorLink® available in my country?

Yes, MirrorLink® is available in all the countries and regions where SEAT operates.

What are the differences between MirrorLink®, Android Auto™ and Apple CarPlay™?

MirrorLink® is not compatible with Android Auto™ and Apple CarPlay™, as they are different technologies. They all coexist in Full Link, although Android Auto™ is designed for mobile devices with the Android™ operating system, and Apple CarPlay™ for iPhone.

Can MirrorLink® be installed in a previous SEAT model?

No, this is not possible.

Where can I find more information about Full Link?

If you have any questions, please see our *Innovation/Connectivity* sections on our website: www.seat.es or www.seat.com or e-mail seat-reponde@seat.es

Operating modes

Radio

Related video



Fig. 187 Radio mode

Radio main menu



Fig. 188 RADIO main menu.

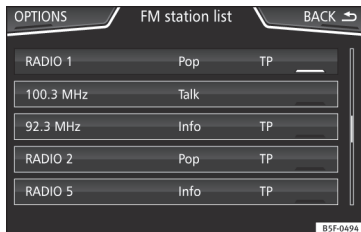

Fig. 189 Radio mode: station list (FM).

Press the infotainment button **RADIO** to open the *Radio* main menu »» Fig. 188.

Radio main menu function buttons

Function button: function	
1	To change the group of memory buttons slide a finger over the memory buttons from left to right or vice-versa
BAND	Allows you to select the frequency band.
STATION LIST	Opens the list of currently receivable radio from the active frequency band.
MANUAL	Allows you to select the frequency manually.
VIEW	Allows you to select the information shown on the screen. Only available in DAB mode.
SETTINGS	Opens the setup menu of the active frequency band (FM, AM or DAB).

Function button: function

◀/▶ Selects the previous or next stored station or of the station list. This setting can be changed in the Radio settings menu (FM, AM, DAB).

1 to 18^{a)} Memory buttons »» page 172.

SCAN Stops the scan function (only visible when the function is under way). It can be activated in the settings menu (FM, AM and DAB).

^{a)} The Media System / Touch Colour model has 15 memories.

Information and possible icons

Display: Meaning

A	View the frequency or the name of the station and, where applicable, the radio text. The name of the radio station and the radio text will only be displayed if equipped with RDS and if it is active.
RDS Off	The RDS radio data service is deactivated.
TP	Traffic information can be retrieved: select Radio > Settings > Traffic station .
TR	No stations with traffic news are available.
☆	The radio station is stored on a memory button. »

Display: Meaning

AF off The tracking of alternative frequencies is disabled.

i Note

- The availability of AM and DAB bands depends on the country and/or equipment. In the event that the AM and DAB bands are not available, the BAND function button text will not be shown.
- Bear in mind that being underground, in tunnels, in areas with tall buildings or mountains can interfere with radio signals.
- Foil or metal-coated stickers attached to the windows may affect reception on vehicles with a window aerial.

Memory buttons



Fig. 190 Radio main menu.

In the *Radio* main menu, you can store stations from all available frequency wavelengths on the numbered function buttons. These function buttons are called “memory buttons”.

Functions of the memory buttons

Selecting the station from the memory buttons	Press the memory button corresponding to the desired station. The stored stations can only be played by pressing the corresponding memory button provided it can be received at your current location.
Change memory bank	Move your finger over the screen from left to right or vice-versa. OR: Press one of the function buttons »» Fig. 190 (A)
Storing the station on the memory buttons	The memory buttons are displayed in three memory banks. Keep and hold the desired memory button until an audible signal is heard, the station will be stored on this memory button. You can also store a station from a station list.

Functions of the memory buttons

Storing the station logo on the memory buttons

A station logo can be assigned to the stations stored on the memory buttons.
A logo is automatically assigned from the database if the Advanced radio settings option is enabled^{a1}.
A logo can also be assigned manually from an external data source (USB/SD card).

^{a1} Not available for the Media System Touch/Colour model.

Media

Introduction



Fig. 191 Related video

“**Media sources**” are audio sources containing audio files on various different data storage devices (e.g. CD, memory card, external MP3 player). These audio files can be played

by the Infotainment system via their corresponding drives or audio input sockets (internal CD drive, memory card slot, AUX-IN multimedia socket etc.).

Copyright

Audio and video files on data storage devices are usually protected by intellectual property rights, as per the corresponding national and international laws. Be aware of the current legal provisions!

i Note

- Do not use memory card adapters.
- SEAT assumes no liability for any deterioration or loss of files on data storage devices.

Media main menu



Fig. 192 Media main menu.

Using the *Media* main menu, different media sources can be selected and played.

- Press the infotainment button **MEDIA** to open the *Radio* main menu »» **Fig. 192**.

It will continue playing the last media source selected from the same point.

The media source being played is indicated on the dropdown list when pressing the **SOURCE** function button »» **Fig. 192**.

If there is no available media source, the *Media* main menu is displayed.

Function buttons of the main Media menu

Function button: function

Indicates the media source being played. Press to select another media source »» **page 174**.

CD: Internal CD drive »» **page 175**.

SD CARD 1, **SD CARD 2***: SD memory card »» **page 175**.

SOURCE

USB: External data storage device connected to the USB port «-» »» **page 175**.

AUX: External audio source connected to the AUX-IN multimedia socket »» **page 176**.

BT AUDIO: Bluetooth® audio »» **page 176**.

Function button: function

SELECTION Opens the track list. Depending on the level, track list, folders or source.

⏮/⏭ Changes track in Media mode or fast forward/rewind.

⏸ Playback stops. The **⏸** function button changes to **▶**.

▶ Playback is resumed. The **▶** function button changes to **⏸**.

SETTINGS Opens the **Media Settings** menu.

Repeat all tracks.

Repeats all the tracks that are on the same memory level as the track being played at that moment. If in the **Media Settings** menu the **Mix/Repeat including subfolders** option is enabled, it also includes the subfolders.

↺
REPEAT

↺
REPEAT

The current track will be repeated.

Random play.

Includes all the tracks that are on the same memory level as the track being played at that moment. If in the **Media Settings** menu the **Mix/Repeat including subfolders** option is enabled, it also includes the subfolders.

MIX

»

Messages and symbols on the Media main menu

Display: Meaning

Displays information about the artist name, album name and song title (CD text , ID3 tag on compressed audio files).

- A** Audio CD: displays track information. If no data is available, it only displays **Track** and the number corresponding to the position it occupies on the data storage device.

- B** Album cover display: If there are various covers within the same folder/album, the system only displays one of them. It prioritizes displaying the covers in the following manner:
1. Cover embedded in the file[s].
 2. Image in file folder.
 3. Default icon of the connected device.

- C** The playing time so far and time remaining in minutes and seconds. In the case of audio files with variable bit rates (VBR) the remaining time may vary.

- TP^{a)}** The TP function is active and can be used: select **Radio > Settings > Traffic programme (TP)**.

- ^{a)}** There are no traffic stations available: select **Radio > Settings > Traffic programme (TP)**.

^{a)} Depends on the market and unit in question.

Note

- When the media source is inserted, playing will not start automatically; it is necessary for the user to select the source. Nor will the media source change when it is ejected.

Changing the Media source

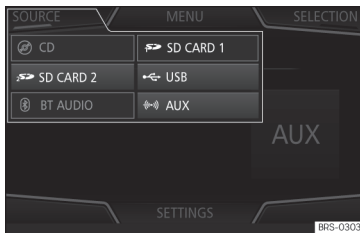

Fig. 193 MEDIA mode: change media source.

- From the *Media* main menu, press the **MEDIA** Infotainment button repeatedly to cycle through the available media sources.
- **OR:** From the *Media* main menu, press the **SOURCE** function button **>>> Fig. 193** and select the desired media source.







In the pop-up window, the Media sources not selected are shown as deactivated (in grey).

When a Media source that has already been played is selected again, playback is re-

sumed from the point at which it was stopped.

Optional Media playback sources

Function button: media source

	Internal CD drive >>> page 175.
	SD memory card >>> page 175.
	
	External data storage device connected to the USB port <-> >>> page 175.
	External audio source connected to the AUX-IN multimedia socket >>> page 176.
	Bluetooth [®] audio >>> page 176.

Note

The Media source can be changed in the Track list view: select Media > View.

Insert or eject a CD

- ✓ Not available for model: Media System Touch/Colour

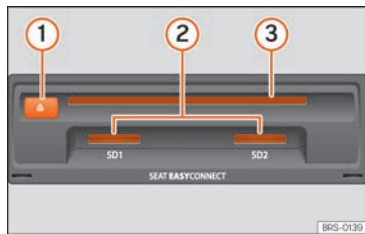

Fig. 194 Slots for data storage devices in the glove compartment.

The driver should refrain from operating the unit while the vehicle is in motion. Insert or change the data storage device before moving off!

The CD drive can play audio CDs and audio data CDs.

Inserting a CD

- Hold the CD with the printed side facing up.
- Push the CD into the slot »» Fig. 194 ③ to the point where it is drawn in automatically.

Ejecting a CD

- Press button  ①.

- The CD in the drive will be ejected and must be removed within approximately 10 seconds.

Insert or eject a memory card

Depending on the features and the country, the vehicle may have one or two slots for SD cards.

Inserting a memory card

Insert the compatible memory card, bevelled edge first and with the label face up (contacts face down), into slot »» Fig. 194 ② or »» Fig. 171 ⑨, until properly inserted.

If a memory card cannot be inserted, make sure it is positioned correctly and is compatible with the unit.

Removing a memory card

The inserted memory cards **must** be prepared for removal.

- From the main *Media* menu, press the **(SETTINGS)** button to open the **Media Settings** menu or press the infotainment button **(MENU)** and then press **(Settings)** to open menu **System settings**.

- Press the **(Remove safely)** function button. A dropdown menu appears with the following options: SD1 Card, SD2 Card* and USB. After correctly ejecting the memory card from the

system, the function button becomes inactive (grey colour).

- Press the inserted memory card. The memory card "jumps" to the eject position.
- Remove the memory card.

Unreadable memory card

If a memory card is inserted and the data cannot be read, the relevant warning appears.

External data storage device connected to the USB port

Depending on the the features and the country, the vehicle may have a USB connection »» page 195.

Audio files on an external data storage device connected to the USB port  can be played and controlled via the Infotainment system.

Where this manual refers to external data storage devices, this means USB mass storage devices containing supported audio files, such as MP3 players, iPods™ and USB sticks.

Only supported audio files are displayed and played. Other files are ignored.

Instructions and restrictions

Compatibility with Apple™ devices and other media players depends on the unit. »

The USB port  supplies the usual USB voltage of 5 volts for a USB connection.

External hard disks with a capacity greater than 32 GB must be reformatted for the FAT32 file system in some circumstances. You will find the necessary software and information on the Internet.

Take into account all other instructions and limitations regarding requirements for media sources.

Disconnecting

Any connected data storage devices **must** be prepared before their disconnection in order to remove them.

- From the main *Media* menu, press the **SETTINGS** button to open the **Media Settings** menu or press the infotainment button **MENU** and then press **Settings** to open menu **System settings**.
- Press the **Remove safely** function button. A dropdown menu appears with the following options: SD1 Card, SD2 Card* and USB. After correctly ejecting the data storage device from the system, the function button becomes inactive (grey colour).
- Now the data storage device can be disconnected.

Note

- **Do not connect an external media player at the same time to play music via Bluetooth® and via the USB port  with the Infotainment system, as this could cause playback limitations.**
- **If the external player is an Apple™ device, it cannot be simultaneously connected by USB and by Bluetooth®.**
- **If a connected device is not recognised, disconnect all the connected devices and try connecting the device again.**
- **Do not use memory card adaptors, USB extension cords or USB hubs!**

External audio source connected to the AUX-IN multimedia socket

Depending on the equipment and country there may be an AUX-IN multimedia socket **>>> page 195**.

The connected external audio source is played over the vehicle speakers and **cannot** be controlled via the Infotainment system controls.

The connection of an external audio source is indicated by **AUX** on the screen.

Connecting an external audio source to the AUX-IN multimedia socket

- Lower the base volume on the Infotainment system.
- Connect the external audio source to the AUX-IN multimedia socket.
- Start playback on the external audio source.
- In the **MEDIA** main menu, press the **SOURCE** function button and select **AUX**.

Connecting an external audio source via Bluetooth®

Bluetooth® Audio mode allows you to listen to audio files being played on a Bluetooth® audio source (e.g., a mobile telephone) connected via Bluetooth® (audio playback by Bluetooth®) over the vehicle speakers.

Conditions

- The Bluetooth® audio source must support the A2DP Bluetooth® profile.
- In the **Bluetooth Settings menu** the **Bluetooth Audio [A2DP/AVRCP] function** must be on. Select **Phone > Settings > Bluetooth**.

Starting Bluetooth® audio transfer

- Activate Bluetooth® visibility on the external Bluetooth® audio source (e.g., mobile telephone).
- Lower the base volume on the Infotainment system.
- In the MEDIA main menu, press the **SOURCE** function button and select **(BT audio)**.
- Press **(Search for new device)** in order to connect an external Bluetooth® audio source for the first time »» page 190.

- **OR:** Select a Bluetooth® external audio source from the list.
- Please refer to the instructions on the screen of the Infotainment system and on the Bluetooth® audio source regarding the rest of the procedure.

You may still need to manually start playback on the Bluetooth® source.

When playback on the Bluetooth® audio source is stopped, the Infotainment system remains in Bluetooth® Audio mode.

Controlling playback

The extent to which the Bluetooth® audio source can be controlled via the Infotainment system depends on the connected Bluetooth® audio source.

The available functions will depend on the Bluetooth® Audio profile that the connected external player supports.

With media players that support the AVRCP Bluetooth® profile, playback on the Bluetooth® audio source can be automatically started or stopped when the unit is switched to Bluetooth® Audio mode or to a different audio source. In addition, it is possible to view or change the track via the Infotainment system.

i Note

- **Due to the large number of possible Bluetooth® audio sources, it is not possible to guarantee fault-free operation of all described functions.**
- **Do not connect an external media player to play music via Bluetooth® and via the USB port ←» » page 175 at the same time with the Infotainment system, as this could cause playback limitations.**
- **If the external player is an Apple™ device, it cannot be simultaneously connected by USB and by Bluetooth®.**

Images

✓ Valid for the model: Media System Plus/Navigation System



Fig. 195 Images main menu.

Using the *Images* menu, image files can be viewed (e.g. photos) individually or as a slideshow.











The image files must be stored on a compatible data storage device (e.g., a CD or an SD card).

- Press the Infotainment **(MENU)** button and then select the **Images** context.
- Press the **(SOURCE)** function button to select the source where the pictures in question are located.

Function button: function

SOURCE	Viewing and selecting the source.
SELECTION	Opens a list of image files. »

Function button: function

	The image viewed was obtained via GPS localisation and upon pressing this function button, the navigator menu opens to start a route to this destination.
	Rotate the view of the image to the left or the right.
	Reset the view of the image.
	To stop the playback of a slideshow. The  function button changes to  .
	To continue the playback of a slideshow. The  function button changes to  .
	To change to the PREVIOUS or NEXT image.
	The same function can be performed by sliding your finger horizontally across the screen.
SETTINGS	Open the Image settings menu.



Enlarging or reducing the view

To enlarge or reduce the view of the image displayed:

- Turn the adjustment knob.

- **OR:** Stretch or reduce the image on the screen using 2 fingers.

Rotating the view/image

To rotate an image, in addition to the buttons provided for this ( / ) you can also press on the screen (e.g. with your thumb) and, while continuing to press with your thumb, slide another finger (e.g. your index finger) around it like a compass either clockwise (to rotate the image to the right) or anti-clockwise (to turn the image to the left). This will rotate the image 90° with respect to its current position.

Requirements for viewing images

Image files	Maximum resolution
BMP	4MP
JPEG	4MP (Progressive Mode)
JPG	64MP
GIF	4MP
PNG	4MP

Navigation¹⁾
Introduction

Fig.196 Related video

General information

Using all the data available, the Infotainment system calculates the optimum route to the destination.

The destination is defined by entering an address or a point of interest, e.g. a petrol station or hotel. Traffic reports, if any, will also be taken into account in the route calculation (dynamic route guidance »» page 186).

Spoken instructions and visual guidance on the navigation unit and on the instrument panel will direct you to your destination.

ⓘ CAUTION

The navigation announcements played may be inaccurate (e.g. due to out-of-date navigation data).

¹⁾ Only available for the model: Navi System

Instructions for navigation

When the Infotainment system is unable to receive any data from GPS satellites (due to a dense tree canopy, underground car park), navigation can still continue using the vehicle sensors.

Possible limitations in navigation

In areas that are not or are only partially digitised on the data storage device, the Infotainment system will still attempt to provide route guidance.

Navigation area and updating navigation data

Roads and streets are subject to constant change (e.g. new roads, changes to street names and building numbers). Therefore, if the navigation data is not updated, then errors or inaccuracies may occur during guidance.

SEAT recommends updating navigation data on a regular basis. Up to date navigation data can be downloaded from www.seat.com or acquired at a SEAT dealer.

Updating and using navigation data from an SD card

The Infotainment system always requires the navigation data that is currently valid for this unit in order to allow all functions to be used in full. Using an old version may lead to errors during navigation.

Updating navigation data

The current navigation data can be downloaded in the internet at www.seat.com and stored in a SD card compatible with the unit.

Suitable SD Cards can be acquired at SEAT dealerships.

The procedure is described on the internet at www.seat.com.

Using navigation data

- Insert the memory card »» page 175.
- Do not remove the memory card while testing. Wait for the testing icon to disappear.

If the inserted memory card contains valid navigation data, the following message appears: **"The source contains a valid navigation database"**. It is now possible to navigate with the memory card data. When the memory card is no longer needed by the hardware, it will be prepared for removal »» page 175.

Note

- The inserted memory card must be prepared before it is ejected »» page 175.
- Press the Infotainment button **MENU**; then press **Settings** to open the **System settings** menu.
- Navigation is not possible without the SD card.
- Do not remove the memory card while the navigation data is in use. This could damage the memory card!
- The navigation memory card may not be used as memory for other files. The infotainment system will not recognise the files saved.
- SEAT recommends only using original SEAT memory cards to use navigation data. The use of other memory cards could limit its operation.

Navigation main menu



Fig. 197 Navigation main menu

The *Navigation* main menu allows you to select a new destination, call up a previously used or stored destination and search for points of interest.

Opening the main Navigation menu

- Press the Infotainment system button **(NAV)** to open the last menu that was open in navigation.

Function buttons and messages on the main Navigation menu

Function button: function

- (A)** The split screen is displayed »» page 185.
- (B)** Messages and function buttons on the map display »» page 185.

Function button: function

(NEW DESTINATION) To enter a new destination »» page 180.

(ROUTE): During route guidance »» page 182.

(MY DESTS.): To activate or manage stored destinations »» page 182.

(POI): Search for points of interest (car parks, fuel stations and restaurants) within a particular search area »» page 184.

(VIEW) To modify or activate or deactivate the split screen and show POI »» Fig. 197 **(A)** »» page 184.

(SETTINGS) Open the **Navigation Settings** menu »» Fig. 197.

New destination (enter destination)



Fig. 198 Search screen.

- In the *Navigation* main menu, press the **(New destination)** function button.
- Press the **(Options)** function button and select the required type of destination (**Search, Address, POI on the route or On map**).
- Using voice control*, if you say Town, street and number, without pauses, and then the instruction "Start Route Guidance" a route to the given destination will start.

Search

Search for addresses and Points of Interest using the keypad to enter them »» Fig. 198.

For cities, post codes and points of interest, the full details must be entered. You can also search for points of interest by names or categories. When necessary, enter the name of the city to refine the search.

»» Fig. 198

- (A)** Press to open the cursor buttons [**<**, **>**], which allow you to move within the text.

Address

After entering a country and a town, you can start navigating towards the centre of the selected town.

When narrowing down the destination address, **please note** that every entry restricts the available range of subsequent selections. For instance, if the street you are looking for is

not in the postcode area you have selected in a previous window, you will not be able to find the street at the street selection stage.

Function button: function

Country: To select the desired country.

City: To enter the desired city or postcode.

Street: To enter the desired street name.

House number: To enter the desired house number.

Junction: To select the desired intersection.

Last destinations: Open the **My destinations** menu »» page 182.

Start: Start route guidance to the selected address.

Using the map

- Select the destination on the map or enter it using GPS coordinates and confirm with **OK**.

Function button: function

Save: To save the selected point of interest in the destination memory »» page 182.

Edit: To edit a destination or to enter another destination.

Route options: To adjust route options, see **Navigation Settings > Route options**.

Start: Starts guided navigation to the selected point of interest.

After starting route guidance

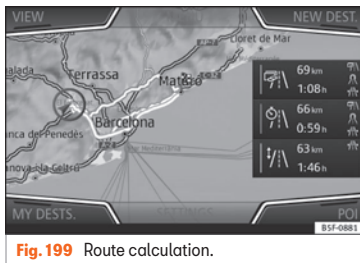

Fig. 199 Route calculation.

After starting route guidance, the route to the first destination will be calculated.

The calculation will be performed in accordance with the data selected in the **Route options** menu.

After starting route guidance, three **alternative routes** will be suggested depending on the selected setup »» **Fig. 199**. These 3 routes correspond to the selectable route options: *Economical, Fast and Short*.

Route criteria: Meaning

Blue route: *Economical route*, the route is calculated by taking into consideration economic factors.

Red route: *Fastest route* to the destination, even if it is necessary to make a deviation.

Route criteria: Meaning

Orange route: *Shortest route* to the destination, even if it results in longer travelling time. The route may have unconventional sections such as secondary roads.

- Select the desired route by pressing it.

Once the route has been calculated, the system gives the first navigation announcement. Before turning, up to 3 navigation announcements will be heard.

- Press the adjustment knob »» **Fig. 172** ⑦ to listen to the last audible navigation instruction.

A navigation announcement informs you when you have reached your “destination”.

A navigation announcement informing you that you have reached the “destination area” is given if the exact destination cannot be reached because it is located in a non-digitalised area.

During **dynamic route guidance**, you receive information about reported traffic congestion on the route. An additional navigation announcement is given if the route is recalculated due to traffic congestion.

During a navigation announcement, you can change its volume using the button ⑧ »» **Fig. 172** ⑥.



For other adjustments to the navigation recommendations, select **Navigation > Settings > Navigation announcements settings**.

i Note

- If you miss a turning during route guidance and are currently unable to turn back, keep on driving until the navigation system offers a new route.
- The quality of the navigation recommendations given by the Infotainment system depends on the navigation data available and any reported traffic problems.

Route

In the *Navigation* main menu, press the **Route** function button.

The **Route** function button is only displayed with route guidance activated.

Function button: function

Stop route guidance: Aborts current route guidance.

Enter destination: To enter a new destination or a new stopover »» page 180.

Congestion ahead: To exclude a section (of 0.2 to 10 km in length) from the current route, e.g. to avoid congestion. To cancel the exclusion, press the **Route** function button and then **Cancel congestion**.

Function button: function

Route details: View route information for current route.

My destinations (destination memory)

The stored destinations can be selected from the **My destinations** menu.

- Press the **My destinations** function button in the main *Navigation* menu.

- Select the desired function button.

Store position, **Routes**, **Destinations**, **Last destinations** or **Home address**.

Store position

- By pressing the **Store position** function button, the vehicle's current position is stored as a **Flagged destination** in the destination memory.

- Mark the **Flagged destination** in the destination memory.

- Press the **Store** function button.

The name can be changed in the following input window. Press the **in** function button to store the destination.

Routes

In the **Route** mode, you can define various destinations (final destination and stopovers).

The **starting point** of a route is always the current vehicle position determined by the Infotainment system. The **destination** is the end point of a route. **Stopover destinations** are driven to before the destination.

- In the *Navigation* main menu, press the **My Destinations** function button.
- Press the **Routes** function button. The routes stored previously will appear.

If you have not stored any routes or want to create a new route, press the **New route** function button and then follow the instructions as for a new destination, before pressing **Store**.

Pressing on a stored route brings up the following function buttons:

Function button: function

Delete: To delete a stored route.

Edit: To edit and store a route.

Start: To start route guidance.

Function buttons and indications in the New route or Edit route menu

Function button or message: function or meaning



Stopover.

	Destination.
	Estimated time of arrival at destination.
	Calculated distance to destination.
	Travelling time.
	Distance to the next stopover.
Press on the destination to display the function buttons.	
	Delete destination.
	To start guidance direct to the selected destination. Destinations that come before the selected destination are ignored.
	To open the detailed view of the destination in question.
Available function buttons.	
New dest.	To add a new destination to the tour.
Destinations	To add a new destination from My destinations to the tour.
Storing	To store the created tour in the tour memory.
Start	To start route guidance.
Calculate	To update calculated distance and estimated arrival time. ^{a)}

Stop	To stop route guidance to the active destination. ^{b)}
	To move a stopover or a destination to another position on the list. Press and drag to move the destination.

^{a)} This function button is only displayed with route guidance activated and when a destination has been added to the tour.

^{b)} This function button is only displayed with route guidance activated.

Last destinations

View of destinations for which a route has already been started.

My destinations

- Press the Options function button and select the desired function button.

Function button: function

Destination memory: View of destinations stored manually and from imported vCards » page 187, **Importing vCards (electronic business cards)**.

Favourites: View of destinations stored as favourites.

Contacts: View of entries in the phonebook that have a stored address (postal address).

Home address

Only one address or position can be stored as the home address at any one time. The

stored home address can be edited or overwritten.

If a home address has already been stored, route guidance will be started to the stored home address.

If a home address has not yet been stored, an address can be assigned as the home address.

Assigning the home address for the first time:

Position: Press to store the vehicle's current position as the home address.

Address: Press to enter the home address manually.

Editing the home address:

The home address can be edited in the **Navigation settings > Manage memory** menu.

Points of interest (POI)

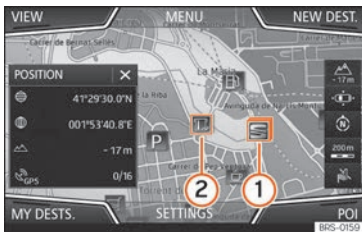

Fig. 200 Points of interest on the map.

The points of interest saved in the navigation data memory are divided into different point of interest categories. Each point of interest category is assigned a symbol for display on the map.

If a database of points of interest has been imported into the Infotainment system, **»» page 187, Importing Personal POI** the category **(Personal POI)** is also shown.

In the **Map settings** menu, the categories of points of interest to display on the map can be configured. Up to 10 categories of points of interest can be selected.

Selecting a point of interest on the map

Function button: function

- ① There are several points of interest in the area. Press this symbol to open a list of points of interest.
- ② The only point of interest in this zone. Press the symbol to open the detailed view of the point of interest.

Quick POI search

In the *Navigation* main menu, press the **(POI)** function button and the three main categories will appear. Alternatively, enter the name of the point of interest to be searched using the new destination keypad, or press **(Search nearby)** on the map **»» table on page 185**.



View

In the *Navigation* main menu, press the **(View)** function button.

Function button: function

- 2D  Map display in two dimensions (conventional).

Function button: function

	Map display in three dimensions (bird's eye view).
3D 	Buildings are also displayed in three dimensions. The places of interest and well-known buildings are shown in detail and in colour.
 a)	To display the destination on the map.
 a)	To display the route on the map.
Auto / Day / Night	To change between day and night format.
Split screen	Press to display the split screen »» page 185 .
POI	Display points of interest on the map.

a) This function button is only displayed with route guidance activated.

Split screen



Fig. 201 Split screen displayed.

The split screen »» **Fig. 201** **A** may display any of the information described below:

- Press on the name of the split screen to select a display option.

Function button: function

Audio: Indicates the selected audio source.

Compass: Displays a compass with the current travelling direction and indicates the current position of the vehicle (street name).

Manoeuvre: Displays a list of the next manoeuvres, POIs or TMCs on the route and pressing them brings up additional information

Most frequent routes^{pl}: Information on the user's most frequent routes.

Function button: function

Position: current vehicle position in coordinates and GPS status (satellite reception).

^{al} This function button is only shown when route guidance is not active or when predictive route guidance is active.

Press the **X** function button to close the split screen.

At any moment during navigation, pressing inside the map will make a pop-up menu appear with the following functions:

Function button: function

Street name or coordinates: shows the details of the point selected on the map.

Only when you press on an icon on the map:

POI: name of the point of interest (when only one appears on the map).

Group of POIs: more points of interest (when you press on the map on various POIs grouped together).

Favourite: name of the favourite.

Home: Home address.

Start route guidance: starts guidance directly.

Add stopover destination: only when you have an active route.

Search nearby: enters in the search menu, but only for the area around the point selected on the map.

Function button: function

Demo mode start (only when demo mode is active)

Map display



Fig. 202 Messages and function buttons on the map display.

Function buttons and messages on the map display.







To activate function buttons **☰** and **⬆️**, press function button **⬅️**.

Function button: function

Auto To select automatic scaling. If the function is active, the symbol is displayed in blue.

Altitude Current altitude indicator. »

Function button: function

	View map scale. Turn the setup button or move your fingers together/apart on the touchscreen to change the scale of the map.
	It can mute or repeat the last announcement, or can change the announcement volume.
	To change the orientation of the map (north-facing or direction of travel). This function is only available in 2D mode.
	To centre the vehicle position on the map.
	To centre the destination on the map. This function button is only displayed if either <i>Display destination on map</i> or <i>Display route on the map</i> is selected »» page 184.
	Briefly zooms in on the map. After a few seconds, it automatically returns to the last selected scale.

Road signs: Depending on the vehicle's equipment, the road signs stored in the navigation data are displayed. Select **Navigation > Settings > Map > Show road signs**.



Traffic reports and dynamic route guidance to the destination (TRAFFIC)



Fig. 203 Traffic reports

The Infotainment system constantly receives traffic reports (TMC/TMCpro) in the background, provided a TMC traffic news station can be received at the current location. The station being listened to does not have to be the traffic news station.

List of available traffic reports

- Press the Infotainment button 
- »» **Fig. 172**  and then press the 

Dynamic route guidance

In order for dynamic route guidance to function, **Dynamic route** must be activated in the route options.

If during route guidance a traffic report is received that affects the route being travelled, an alternative route will be searched for if the Infotainment system calculates that time can be saved.

Traffic reports on map (selection)

Symbol: Meaning

	: Slow traffic
	: Traffic jam
	: Accident
	: Slippery road surface (ice or snow)
	: Slippery road surface
	: Danger
	: Road works
	: Strong wind
	: Road closed to traffic

During route guidance, traffic congestion that does **not** affect the route calculated is displayed in grey.

Predictive navigation

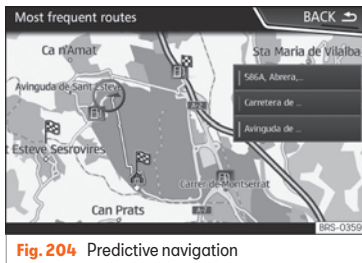

Fig. 204 Predictive navigation

When you activate Predictive navigation, the system detects and stores in the background routes that are frequently followed, without them being active destination routes. This function has no navigation announcements unless the user requires them, getting them by pressing the adjustment knob
»» **Fig. 172** (7).

- On the main screen of the Navigation menu, in the pop-up window, press the **Frequent routes** button. To display frequently followed routes press the **Show on map** button
»» **Fig. 204**.

Importing vCards (electronic business cards)

Importing vCards to the destination memory

- Insert the data storage device with the stored vCards or connect it to the Infotainment system »» **page 172**.
- Press the **SETTINGS** function button in the main **Navigation** menu.
- In the **Navigation settings** menu, press the **Import destinations** function button.
- Select the data carrier with the vCards saved in the list.
- Press **Import all vCards from this folder**.
- Confirm the import notice with the **OK** function button.

The saved vCards will now be in the destination memory »» **page 182** and may be used for navigation.

i Note

Only one address per vCard can be imported. In the event any vCards have multiple addresses, only the main address will be imported.

Importing Personal POI

Importing the Personal POI to a points of interest destination memory

- Insert the data storage device with the stored Personal POI or connect it to the Infotainment system »» **page 172**.
- Press the Infotainment button **NAV** and then select **Settings**.
- In the **Settings** menu, press the **Manage memory** function button.
- Press **Update my POIs** and then press **Update** and **Next** to import the Personal POIs.
- Confirm the import notification with the **OK** function button.

The stored Personal POI are now in the points of interest destination memory »» **page 184** and can be used for navigation purposes.

The stored Personal POI can be deleted in the **Navigation Settings > Manage Storage** menu.

Navigation with images

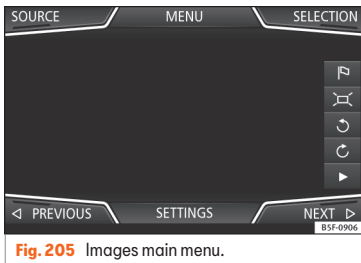

Fig. 205 Images main menu.

Selecting an image and starting route guidance

Bear in mind the requirements and formats of the compatible images.

- Insert the data storage device with the stored images or connect it to the Infotainment system.
- Press the Infotainment **MENU** button and then select the **Images** context.
- Press the **SOURCE** >>> Fig. 205 function button and select the data storage device where the images are stored.
- Select the desired image.

- If the image displayed was taken using GPS localisation, the **GPS** function button will appear. Press to start guidance to a destination.

Route guidance in Demo mode

If demo mode is activated in the **Navigation Settings** menu, an additional pop-up window opens when you start route guidance.

- Pressing the **Demo mode** function button starts a “virtual route guidance” to the destination you have entered.
- If you press the **Normal** function button, a “real route guidance” starts.

Vehicle Menu

Introduction to using the Vehicle menu

By pressing button **CAR** / of the infotainment system you will access its main menu with the following options:

- **VIEW**

- **MINIPLAYER**, in the top right corner (Radio or Media function)
- **PREVIOUS-NEXT** (to change screen)
- **SETTINGS** >>> page 24

With the function button **View** you can access the following information:

Consumers

By pressing the **Consumers** button, information on the status of the vehicle's main consumption devices is obtained. It is shown via a consumption indicator bar in l/h (gal/h)¹⁾.

Driving data

The onboard computer is equipped with 3 memories that work automatically. In these memories you can see the distance travelled, average speed, time passed, average consumption and autonomy of the vehicle.

Ecotrainer*

If the corresponding equipment is available, the ECOTRAINER will provide information on driving style. The information on driving style is only evaluated and displayed when moving forward.

¹⁾ In the case of Gas (CNG) vehicles, the units are in kg/h.

Vehicle status

Press the **Vehicle status** button to access information on the **Vehicle status** messages and **Start-Stop system**. The Vehicle status messages are displayed, in addition to being specified on the corresponding button.

Telephone

General information



Fig. 206 Related video

The Telephone functions described below can be used through the Infotainment system if there is a mobile telephone connected to it via Bluetooth® **»»» page 191.**

In order for the mobile telephone to be able to connect to the Infotainment system the telephone must be equipped with **Bluetooth®**.

If there is no mobile telephone connected to the Infotainment system, the telephone management system will not be available.

The instructions shown on the screen for the telephone menus will depend on the mobile telephone used. There may be variations.

Only use compatible Bluetooth® devices. For further information on compatible Bluetooth® products, ask your nearest SEAT dealer or check on the internet.

Use the instruction manual of the mobile telephone and of any accessories.

If you detect any operating issues between your mobile telephone and the Infotainment system, restart your mobile by switching it off and on again.

⚠ WARNING

General, mandatory, legal and country-specific instructions and laws for the use of mobile phones inside the vehicle must always be considered.

⚠ WARNING

Speaking by telephone and using the mobile telephone management system whilst driving can distract you from the road and cause an accident.

- Always drive carefully and responsibly.
- Select volume settings that allow you to easily hear signals from outside the vehicle at all times (e.g. emergency services sirens and horns).

- In areas of little or no coverage or, in some cases, in a tunnel, garage or underpass, your call may be cut off and you may not be able to make even emergency calls.

⚠ WARNING

If a mobile telephone is not secured or is incorrectly secured in the vehicle, it could move around the passenger compartment in the event of a sudden driving manoeuvre or emergency stop, resulting in injury.

- While the vehicle is in motion, always secure the mobile telephone properly outside the airbag deployment zone.

⚠ WARNING

Mobile telephones may interfere with and alter the correct operation of pacemakers if they are carried directly over them.

- Maintain a minimum distance of at least 20 centimetres between the aerials of the mobile telephone and the pacemaker.
- Do not carry your switched-on mobile telephone in your breast pocket directly over the pacemaker.
- If you suspect interference, switch off the mobile telephone immediately.

ⓘ CAUTION

High speeds, poor weather or road conditions and the quality of reception can all



affect the audio quality of a telephone conversation in the vehicle.

Note

- Restrictions on the use of devices using Bluetooth® technology may apply in some countries. For further information, contact the local authorities.
- If you wish to connect a device to the telephone management system via Bluetooth® technology, consult the safety warnings in its instruction manual. Only use compatible Bluetooth® devices.

Places with special regulations

Switch off the mobile telephone and the mobile's Bluetooth® function in places with a risk of explosion. In the majority of cases, these places are signposted, but not always clearly **>>>  in General information on page 189.** They include, for example:

- the vicinity of chemical pipelines and tanks
- The lower decks of boats and ferries.
- In the proximity of vehicles that run on liquid gas (such as propane or butane).
- places where the air is laden with chemicals or particles such as flour, dust or metal powder.

- all other places where the vehicle engine must be switched off.

WARNING

Switch off the mobile phone in areas with a risk of explosion! The mobile telephone can automatically connect to the mobile telephone network again if it loses the Bluetooth® connection to the telephone management system.

CAUTION

In areas where special regulations apply or the use of mobile telephones is prohibited, both the telephone and the telephone management system must be switched off. The radiation produced by the mobile telephone when switched on may interfere with sensitive technical and medical equipment, possibly resulting in a malfunction or damage to the equipment.

Bluetooth®

Bluetooth® technology allows a mobile telephone to be connected to your vehicle's telephone management system. In order to use the telephone management system with a mobile telephone with Bluetooth® technology, it is first necessary to pair them.

Some Bluetooth® mobile telephones detect and automatically connect when turning on

the ignition if a connection has been previously established. For this to take place the telephone must be switched on and its Bluetooth® function activated, and there must be no active Bluetooth® connection with other devices.

Bluetooth® connections are free.

Bluetooth® is a registered trademark of Bluetooth® SIG, Inc.

Bluetooth profiles®

When a mobile phone is connected to the telephone management system, a data exchange takes place via one of the Bluetooth® profiles.

- **Hands-Free Profile (HFP):** When connecting a mobile telephone to the phone manager through the HFP the calls can be managed via the Infotainment system.
- **Audio profile (A2DP):** This profile makes it easier to transmit audio to the infotainment system with stereo quality. This function may require connecting additional profiles for managing and controlling audio playback.
- **Phone book access profile (PBAP):** Serves to download phone book contacts from the mobile telephone to the Infotainment system.

- **Message profile (MAP):**¹⁾ Serves the download and synchronise short messages (SMS) of the mobile telephone to the Infotainment system.

Note

To prevent them from being heard through the speakers, the button and mobile telephone alert tones must be disconnected. Where necessary, disconnect the headset from the mobile telephone you wish to connect to the system.

Pairing and connecting a mobile telephone to the Infotainment system

In order to manage a mobile telephone via the Infotainment system, it is necessary to pair both devices **once**.

For your safety, we recommend you make the link when the vehicle is stationary. In some countries it is not possible to perform the pairing with the vehicle running.

Conditions

You must guarantee the following setup in the mobile phone and the Infotainment system:

- The ignition must be switched on.
- The **Bluetooth® function** of the mobile telephone and the Infotainment system must be active as well as visibility.
- The **keypad lock** on the mobile telephone must be deactivated.

Follow instructions in the manual for the mobile telephone.

During the pairing process, it is necessary to enter data via the mobile telephone's keypad.

Pairing a mobile telephone

- Make sure the mobile device's Bluetooth® function is activated and visible.
- Press the infotainment **PHONE** button.
- Press the **Find telephone** function button and then **Results**.

OR:

- Press the infotainment **PHONE** button.
- Press the **SETTINGS** function button.
- Press the **Select mobile phone** function button and then **Results**.

OR:

- Press the infotainment **PHONE** button.
- Press the **SETTINGS** function button.

- Press the **Bluetooth** function button.
- Press the **Find devices** function button and then **Results**.

The name of the Bluetooth® function of your Infotainment system will be displayed on the main *Telephone* screen and you can edit this name via the **Bluetooth settings** menu

The search process can take up to 1 minute. On the screen, the system will dynamically update the names of the Bluetooth® devices found.

As soon as the search is completed, the names of the Bluetooth® devices found are displayed on-screen.

- Select the Bluetooth® device you want to connect on the infotainment system. In certain circumstances, it is possible that to finish the connection between the two devices, you must enter additional data in the mobile telephone and Infotainment system.
- Use your mobile telephone to enter and confirm your PIN code, as indicated in the display of the infotainment system.
- If more Bluetooth® profile pairing requests are received on the mobile telephone, make sure to reply to them. »

¹⁾ Not available for the Media System Touch/Colour model.

OR:

- Compare the PIN code shown on the display of the Infotainment system with that shown on the mobile telephone. If they match, confirm on **both** devices.

When the pairing has been finalized correctly, the *Telephone* main menu will appear. The phone book, call list and SMS messages stored in the mobile phone will be loaded once the requests have been accepted in the mobile phone. The duration of the loading process depends on the amount of data stored on the mobile telephone. After downloading, the data will be available on the Infotainment system.

Pairing and connection of mobile telephones

You can pair up to 20 mobile telephones to the Infotainment system, but the number of simultaneous connections varies:

- Media System Touch / Colour: a phone connected to the hands-free profile and the same or a different device connected to the Bluetooth® audio profile.
- Media System Plus / Navi System: two mobile phones simultaneously connected to the hands-free profile and one of them is also connected Bluetooth® audio profile.

When the Infotainment system is switched on, it automatically connects to the last connec-

ted mobile telephone. If it is not possible to connect to this mobile telephone, the telephone management system will try to automatically connect to the next mobile telephone on the list of paired devices.

The **maximum** range of the Bluetooth® connection is approx. **10 meters**. The active Bluetooth® connection disconnects if this distance is exceeded. The connection is **automatically** re-established as soon as the device is once again within Bluetooth® range.

⚠ WARNING

Do not perform the pairing and connection process while driving. This may cause an accident!

i Note

- **It may be necessary to confirm the phone book data and SMS transfer request on the mobile telephone.**
- **Check that there are no requests pending acceptance in your mobile phone. If there are, this could block some of the functions in the Telephone menu.**

Telephone main menu



Fig. 207 Phone main menu.

Assign a user profile

The data from the phonebook, the call lists and the stored speed dial buttons are assigned to a user profile and remain stored on the telephone management system. This information will be available every time the mobile telephone is connected to the telephone management system.

After the first connection, it will take a few minutes for the data from the phonebook of the linked mobile phone to be available in the Infotainment system. The next time that the mobile telephone is connected (e.g. on the next journey) the phonebook is updated automatically.

If any entries in the mobile phonebook have been modified while connected, a manual update of the phonebook data can be

initiated from the **User profile settings** menu.

Telephone management can store a maximum of 4 user profiles for mobile telephones. If you wish to link/connect another mobile phone, the oldest user profile will automatically be replaced.

Telephone management system function buttons

- Press the infotainment button **PHONE** to open the *Phone* main menu.

Function button: function	
①	Name of connected mobile telephone. Press the icon to the left to connect or pair with another mobile telephone.
②	Speed dial buttons, to which telephone numbers from the phonebook may be assigned respectively.
③	To change to another telephone connected to the hands-free profile. This button will only be visible when there are two telephones connected as hands-free. The active user profile corresponds to the telephone appearing on the screen.
DIAL NUMBER	To open the number pad and enter a telephone number » page 194.
CONTACTS	To open the phonebook of the connected mobile telephone.

Function button: function	
SMS ^{a)}	To open the menu for SMS messages.
CALLS	To open call lists of the connected mobile telephone » page 194.
SETTINGS	To open the Telephone settings menu.

^{a)} Not available for the Media System Touch/Colour model.

Display and symbols of the telephone management system



Fig. 208 Active call.

Display: Meaning » Fig. 208	
A	Name of the mobile network operator (provider) to which the mobile telephone is connected.

Display: Meaning » Fig. 208	
B	View of stored telephone number or name. If the name stored in the phonebook has an assigned photo, it can be displayed: select Telephone > Settings > User profile > Show pictures for contacts* .
	Press to accept a call.
	Press to end a call.
	OR: Press to reject an incoming call.
	Press to mute or to reactivate the ring tone during an incoming call.
	Press to mute the microphone during an active call and to reactivate it.
	This button keeps the call active. While the call is on hold the listener will not hear the conversation. To reactivate it, press the call accept button . To reject it, press the reject button .
	Press to add a participant to the active call.
	Charge status of a mobile telephone connected via "Hands-free profile" (HFP) Bluetooth®.
	Strength of coverage signal received by the mobile telephone.

Enter telephone number menu

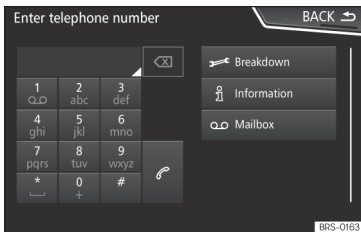

Fig. 209 Enter telephone number menu.

Open the Enter telephone number menu

Press the **DIAL NUMBER** function button from the **PHONE** main menu.

Possible functions

Enter telephone number	<p>Entering a phone number with the keypad.</p> <p>Press the function button to make a call.</p>
Select a contact from the list	<p>Enter the first letters of the contact to find using the keypad. The available entries appear in the phonebook.</p> <p>Select the desired contact from the phonebook to make the call.</p>

Possible functions

Enter the country code	<p>To enter a country code, instead of the first two digits (international access code e.g. "00") you can enter the character "+".</p> <p>Press the function button for approx. 2 seconds to add the +.</p>
Breakdown service call	<p>Press the function button to obtain help in the event of breakdown. For this the network of SEAT dealerships is available to you with their Mobility Service.</p>
Information call	<p>Press the function button to obtain information on the SEAT brand and the additional services contracted related to traffic and travel.</p>
Call mailbox	<p>Press the Voice mail function button to make the call.</p> <p>OR: Press the function button for about 2 seconds to make a call.</p> <p>If the number for the mailbox has not yet been stored, enter it and confirm with .</p>

Note

- Breakdown service and information calls can incur an additional cost on your telephone bill.
- The Roadside Assistance and Information services might not work properly, for exam-

ple, if the vehicle and the operator of the connected mobile telephone are in different countries. If you are not able to use these services contact an authorised SEAT workshop.

Call Menu (call lists)

Possible displays in the Calls menu

Display: Meaning

	Missed calls: Displays the numbers of missed and unanswered calls.
	Dialled numbers: Indicates the numbers dialled on the mobile telephone and on the Infotainment system telephone management system.
	Received calls: Indicates the numbers of the calls received on the mobile telephone and on the Infotainment system telephone management system.

Note

The availability of the call lists will depend on the mobile phone used.

Multimedia

USB/AUX-INPort

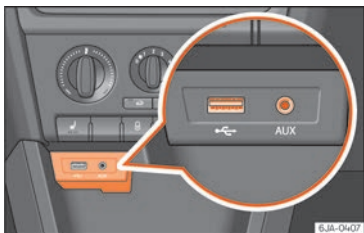

Fig. 210 Centre console: USB/AUX-IN input.

Depending on the special characteristics and the country, the vehicle may have a USB/AUX-IN port.

The USB/AUX-IN input is located above the storage compartment in the front centre console »» **Fig. 210**.

The operating description is located in »» page 172.

Driving

Start and driving

Starting and stopping the engine

Introduction

Read the additional information carefully
»»  page 20

WARNING

- When moving with the engine switched off, the ignition key must always remain in position ② »» Fig. 211 »» page 197 (ignition on). The control lamps will light up in this position. Otherwise, the steering lock could engage suddenly. Risk of accident!
- Do not remove the key from the ignition until the vehicle has come to a standstill and is secure (e.g. the handbrake is engaged). Otherwise, the steering lock could suddenly engage. Risk of accident!
- Always take the ignition key with you when you leave the vehicle. This is particularly important if you leave children in the vehicle. Children could, for example, start the engine with the subsequent risk of accident.

- Never leave the engine running in unventilated or closed rooms. The exhaust gases contain carbon monoxide, an odourless and colourless poisonous gas. Risk of fatal accidents! Carbon monoxide can cause people to lose consciousness and can cause death.
- Never leave the vehicle unattended if the engine is running.
- Never switch the engine off until the vehicle has come to a complete stop. Risk of accident!

CAUTION

- The starter motor may only be used (key position ③ »» Fig. 211 »» page 197 in the ignition) if the engine is off. Using the starter motor when the engine is running could damage it.
- Immediately release the ignition key when the engine starts, otherwise damage could be caused to the starter motor.
- When the engine is cold, you should avoid high engine speeds, driving at full throttle and over-loading the engine before it reaches operating temperature. Risk of engine damage!
- Do not tow-start the engine. Risk of engine damage! In vehicles with a catalytic converter, fuel that has not been burned could reach the catalytic converter and catch fire in it. This would lead to a fault in the catalytic converter. You may use the

battery from another vehicle to help you start your engine »»  page 54.

- After prolonged and demanding operation of the engine, when the journey has ended, do not stop the engine immediately. Let the engine run at idle for about one more minute. This will stop the engine from overheating.

For the sake of the environment

Do not warm up the engine when the vehicle is stationary. If possible, move off immediately after starting the engine. This will help the engine reach operating temperature more quickly, reducing the quantity of emissions.

Note

- The engine can only be started with the original SEAT key.
- Loud running noises may be heard briefly after cold-starting the engine. This is normal and is no cause for concern.
- After the engine has been stopped and the ignition switched off, the radiator fan may continue running for around 10 minutes.
- If the engine still does not start after a second attempt, the fuel pump fuse might have blown. Check it and replace if necessary »» page 83 or contact your Specialised Service.

- You should always engage the steering lock when you exit the vehicle. This will hinder any attempts at theft.

Ignition lock

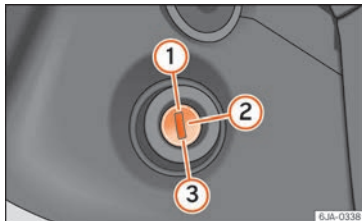

Fig. 211 Ignition key positions.

Petrol engines

- ① – Ignition switched off, engine stopped, steering can be locked
- ② – Ignition switched on
- ③ – Starting

Diesel engines

- ① – Fuel supply stopped, ignition switched off, engine stopped, steering can be locked
- ② – Engine pre-heating, ignition switched on

③ – Starting

To engage the **Steering lock** without the key in the ignition, turn the steering wheel slightly until you hear it engage.

In vehicles with automatic gearbox, the ignition key can only be removed when the selector lever is in position **P**¹⁾.

If the **steering lock is engaged** and it is difficult or impossible to turn the key to position ②, release the lock by turning the steering wheel slightly in both directions.

Start-up lock security system (electronic immobiliser)

There is an electronic chip in the key. The electronic immobiliser is deactivated when the key is inserted into the ignition. The electronic immobiliser is automatically activated when the key is removed from the ignition.

The engine will not start if an unauthorised key is used.

The informative display indicates:

Immobiliser active!

Starter button



Fig. 212 In the steering column: start-up push button for the Keyless Access lock and start-up system. The layout in right-hand drive vehicles is symmetrical.

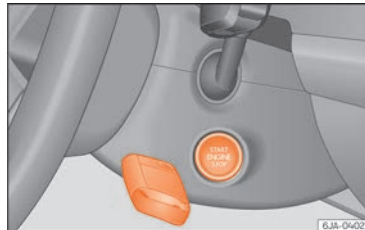

Fig. 213 Emergency ignition in vehicles with Keyless Access.

¹⁾ Depending upon country.

The start-up button may only be used if there is a valid key in the vehicle.

Opening the driver's door **when exiting the vehicle** activates the electronic lock on the steering column if the ignition is disabled.

Switching the ignition on/off

• Briefly push the start-up button »» Fig. 212 without touching the brake or clutch pedal »» ⚠.

Emergency starting function

If no valid key is detected inside the vehicle, an emergency start-up will be required. The relevant message will appear in the dash panel display. This may happen when, for example, the vehicle key battery is very low or flat:

- Immediately after pushing the start-up button, keep the vehicle key next to the steering column »» Fig. 213.
- The ignition connects and the engine starts automatically.

Emergency disconnection

If the engine does not stop after briefly pressing the start-up button, an emergency disconnect will be required:

- Press the starter button twice within 1 second or press it once for more than 2 seconds »» ⚠.

- The engine turns off automatically.

Engine restart feature

If no valid key is detected inside the vehicle after the engine stops, you will only have 5 seconds to restart it. A warning will display on the dash panel screen.

After this interval, it will not be possible to start the engine without a valid key inside the vehicle.

⚠ WARNING

Any accidental movement of the vehicle could result in serious injury.

- **When pressing the start-up button, do not press the brake or clutch pedal, this way the engine will start immediately.**

⚠ WARNING

If vehicle keys are used negligently or without due care, this may cause accidents and serious injury.

- **Never leave any key inside the vehicle when exiting. Otherwise, a child or unauthorised person could lock the vehicle, start the engine or connect the ignition and, in this way, operate electronic equipment (e.g. the windows).**

Note



- **In diesel vehicles with the Keyless Access system, there may be a delay in the engine starting if it requires preheating.**
- **If the vehicle is stationary for a long time with the ignition on, the vehicle battery might be discharged and it might not be possible to start the engine.**

Starting the engine

Vehicles with a **diesel engine** are equipped with a glow plug system. When you switch on the ignition, the glow plug warning lamp  will light up. The engine can be started straight away when the lamp switches off.

Do not connect electrical appliances during preheating so as not to drain the vehicle battery unnecessarily.

Starting the engine

- Move the gearbox lever into neutral or move the selector lever to position **P** or **N** and pull firmly on the handbrake.
- Press the clutch pedal all the way down and start the engine  »» Fig. 211 »» page 197, without pressing the accelerator. Keep the clutch pedal pressed down until the engine starts.
- Release the ignition key as soon as the engine starts. The key returns to position .

- If the engine does not start after 10 seconds, turn the key back to position ①. Repeat the action after 30 seconds.
- Release the handbrake before moving off.

Switching off the engine with the key

Stop the engine by turning the ignition key to position ① »» Fig. 211 »» page 197.

Brakes and brake servo systems

Introduction

WARNING

- The brake servo only works when the engine is running. Braking when the engine is switched off requires applying more strength to the brake pedal. Risk of accident!
- Press down on the clutch pedal when stopping and braking with a manual gearbox, petrol engine vehicle at low speed. Otherwise, the brake servo might not work properly. Risk of accident!
- In the event of damage to the standard front spoiler or where a different front

spoiler, wheel trims, etc. are subsequently fitted, make sure the air vent to the brakes on the front wheels is not blocked. Otherwise, braking operations may be impaired. Risk of accident!

- Always fully release the handbrake. If it is only partially released, this will cause overheating of the rear brakes, which can impair the function of the brake system. Risk of accident!
- Never leave children unsupervised in the vehicle. They could release the handbrake or move the gear lever. The vehicle could start moving. Risk of accident!
- Insufficient fuel can cause the engine to run irregularly or to switch off. Brake assist systems could be impaired. Risk of accident!
- Always adjust your driving style to suit visibility, the weather and road and traffic conditions. The best vehicle safety offered by brake assist systems must never encourage you to run greater risks. Risk of accident!

CAUTION

- Observe the information concerning new brake pads »» page 210.
- Where braking is not necessary, do not wear down the brake pads by pressing down gently on the brake pedal. This causes the brakes to overheat, increasing their wear and increasing braking distances.

- To ensure the brake assist systems work properly, all wheels must be fitted with tyres approved by the manufacturer.

Note

- If you brake suddenly and the brake system control unit regards the situation as hazardous for the drivers behind you, the brake lights will begin to flash automatically. After reducing speed to approximately 10 km/h (6 mph) or stopping the vehicle, the brake lights will stop flashing and the hazard warning lights will switch on. The hazard warning lights are automatically switched off when you accelerate or restart the vehicle.
- On long, steep gradients, reduce your speed and change to a lower gear (manual gearbox) or move the selector lever to a lower gear position (automatic gearbox). This uses the force of the engine and the brakes do not suffer as much. If you still have to brake, do so intermittently, pressing down repeatedly on the brake pedal.
- Vehicle modifications (e.g. to the engine, brakes, frame or a combination of wheels and tyres) could impair the brake assist systems »» page 240, Accessories and modifications to the vehicle.
- In the event of a fault in the ABS system, the ESC, TCS and EDL are switched off automatically. A fault in the ABS is indicated by the  »» page 202 warning lamp.

Control lamps

(R) It lights up red

Brake fluid level too low » page 250 or fault in the brake system.

Do not carry on driving! Stop the vehicle, switch off the engine and check the level of the brake fluid » page 250.

The information display shows: **Brake fluid Instruction Manual!**

(P) It lights up red

Parking brake engaged » page 200.

The warning lamp turns off when the handbrake is released.

(R) It lights up yellow

Front brake pads worn.

WARNING

- The following indications must be taken into account when opening the engine compartment » page 244, Engine compartment.
- If the warning lamp (R) illuminates together with the warning lamp (P) » page 202, **stop the vehicle!** Go to a technical service.
- A fault in the brake system or in the Anti-lock brake system (ABS) can lead to longer braking distances – Risk of accident!

Brakes

Wear

The rate of wear of the brake pads depends on the driving style and on the way in which the vehicle is used. The brake pads will wear more quickly if you use your vehicle frequently in urban traffic and short trips or drive in a sporty style. Under these **demanding conditions**, visit your specialised service, even before the scheduled service date, so that the thickness of the brake pads can be measured.

Wet roads or road salt

If brakes are wet or frozen, or if you are driving on roads which have been gritted with salt, braking power may set in later than normal. Dry the brakes as soon as possible by braking repeatedly.

Corrosion

Long periods of inactivity and little use can lead to rust on the brake discs and dirt on the brake pads. Where the brake system is subjected to light stress or in the case of corrosion, clean the brake discs by braking fully several times at a high speed.

Brake system fault

If you notice that the braking distance suddenly increases and the brake pedal can be

pressed down more fully, there may be a fault in the brake system. Visit a specialised service immediately and adjust your driving style to the extent of the damage and to limit the effect of the brakes.

Low brake fluid level

Insufficient brake fluid could cause faults in the brake system. The brake fluid level is controlled electronically » page 200.

Brake servo

The brake servo supplements the pressure you exert on the brake pedal. The brake servo only works when the engine is running.

Handbrake

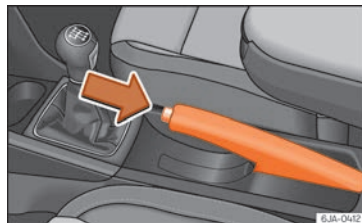

Fig. 214 Centre console: handbrake.

Applying the handbrake

– Pull the handbrake lever up all the way.

Releasing the handbrake

- Pull the handbrake lever up slightly and press the unlock button **at the same time** » Fig. 214.
- Keep the button pressed down and push the lever all the way down.

Control lamp

The warning lamp lights up when the handbrake is applied with the ignition on .

Additionally, driving the vehicle at speeds exceeding 6 km/h [4 mph] for at least 3 seconds produces an audible warning.

The informative display indicates:

Release the handbrake!

Braking and stability systems

Control lamps

It lights up

Fault in the ESC or disconnection caused by the system.
As the ESC operates in conjunction with the ABS, the ESC light will also come on if a fault should occur in the ABS.

Flashes

ESC or ASR activated.

It lights up

ASR manually deactivated.

It lights up

ABS faulty or does not work.

The control lamps light up together when the ignition is switched on and should turn off after approximately 2 seconds. This is the time taken for the function check.

Electronic Stability Control (ESC)

The ESC system increases control of the vehicle in emergency situations, e.g. during a sudden change in direction. Depending on the driving conditions, it reduces the risk of skidding and increases driving stability.

The system uses the steering wheel angle and road speed to calculate the changes of direction desired by the driver, and constantly compares them with the actual behaviour of the vehicle. When irregularities occur, for example, if the vehicle begins to skid, the ESC brakes the appropriate wheel automatically.

The  warning lamp on the general instrument panel starts flashing when the system is working.

The **stability (ESC)** system includes the following systems:

- Anti-lock brake system (ABS),
- Traction control system (TCS),
- Electronic differential lock (EDL),
- Hydraulic brake assist system (HBA),
- Hill hold control (HHC).

The ASR should be switched on at all times. Only under certain circumstances should the system be switched off, e.g.

- driving with chains,
- driving in deep snow or on very soft surfaces,
- During the “swinging movement” required to remove a stuck vehicle

Switch the ASR back on as soon as possible.

Brake assist system (HBA)*

The HBA system is activated when you press down on the brake pedal suddenly. It increases braking power, helping to reduce braking distances. To reduce braking distance as much as possible, keep the brake pedal pressed down firmly until the vehicle comes to a standstill.

»

With the help of this system, the ABS is activated more quickly and more efficiently.

The brake assist function is deactivated automatically when the brake pedal is released.

Hill hold control (HHC)*

The HHC system makes it easier to start the vehicle on hills. The system maintains the brake pressure created by pressing down on the brake pedal for 2 seconds after it has been released. Your foot can be removed from the brake pedal and you can use the accelerator pedal and move away on a hill without having to use the handbrake. The brake pressure drops as the accelerator pedal is pressed. If the vehicle cannot be started, it will start to move backwards after 2 seconds.

The HHC is activated on gradients of over 5%, if the driver door is closed. It only works for starting on hills, moving both forward and in reverse. It is not activated during start-up down hill.

Control lamp

If the control lamp  flashes, the ESC is working.

If the  warning lamp illuminates on ignition, the ESC system may have switched off due to technical reasons. Turn off the ignition and turn it on again. Upon switching on the ignition again, if the warning lamp has switched

off, this means the ESC is functioning correctly again.

If the  warning lamp is illuminated there is a fault in the ESC.

The informative display indicates:

Fault: electronic stability control (ESC)

or

Fault: traction control system (ASR)

Go to a technical service.

Note

If the battery is disconnected and connected again, the yellow warning lamp  lights up when the ignition is switched on. This warning lamp must switch off after covering a short distance.

Anti-lock brake system (ABS)

The ABS system prevents the wheels locking during braking. This helps the driver keep control of the vehicle.

The driver is made aware of ABS assistance **by the pulsating of the brake pedal** and a characteristic noise.

Keep the brake pedal pressed down while the ABS is working. The ABS will switch off when

the brake pedal is released. Never brake intermittently while the ABS is working!

Control lamp

If the  warning lamp is illuminated, there is a fault in the ABS.





The informative display indicates:

ABS fault

The brake system alone is operational in the vehicle, without ABS.

Go to a technical service.

WARNING

- If the  warning lamp illuminates together with the  page 200  warning lamp, , stop the vehicle! Go to a technical service.
- A fault in the Anti-lock brake system (ABS) can lead to longer braking distances – Risk of accident!

Anti-slip regulation of the driving wheels (ASR)*

If the wheels start to slip, the TCS adapts the engine speed to the driving conditions. Particularly in unfavourable conditions, the TCS helps starting, accelerating and hill starts.

If the control lamp  flashes, the ASR is working.

If the  warning lamp illuminates on ignition, the TCS system may have switched off due to technical reasons. Turn off the ignition and turn it on again. Upon switching on the ignition again, if the warning lamp has switched off, this means the TCS is functioning correctly again.

If the  warning lamp remains illuminated, there is a fault in the TCS.

The informative display indicates:

Fault: traction control system (ASR)

Go to a technical service.

Electronic differential lock

If one of the wheels starts to skid, the EDL brakes that wheel, transmitting the driving force to the other wheels. This increases vehicle stability and improves driving stability.

To prevent the disc brake of the braking wheel from overheating, the EDL cuts out automatically if subjected to excessive loads. The vehicle will continue to function normally without EDL. The EDL will switch on again automatically when the brake has cooled down.

Manual gearbox

Changing gears

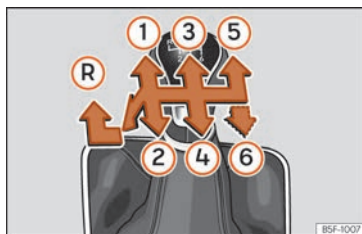



Fig. 215 Gear shift diagram of a 5- or 6-speed manual gearbox

Read the additional information carefully
»  page 36

When changing gear, always depress the clutch pedal fully and keep it pressed down to avoid excessive clutch wear.

In order to drive at an optimum RPM, follow the gear change indications » page 208.

Engage reverse gear only when the vehicle is stopped. On engaging reverse gear while the engine is running, first wait a moment with the clutch pedal pressed down fully to limit gear shift noise.

The reverse lights switch on when the reverse gear is selected and the ignition is on.

WARNING

Never engage reverse gear when moving forward. Risk of accident!

Note

Do not rest your hand on the gear lever while driving. The pressure of your hand could lead to premature wear of the gear system.

Automatic gearbox

Basic information

The gearbox changes up and down automatically. The gearbox can be set to **Tiptronic** mode. The gears can be changed manually in this mode » page 206.

The engine can be **started** only in position **P** or **N**. If the selector lever is not in these positions when locking the steering, switching the ignition on or off or starting the engine, the information display will show **!Move the selector lever to the P/N!** position, or on the general instrument panel → **P/N**.

At temperatures below -10°C [14°F], the engine can only be started in position **P**.

If you park your vehicle in a flat surface, move the selector lever to position **P**. On a slop, first »

engage the handbrake firmly and then move the selector lever to the parking position. This reduces the load on the lock mechanism while making it easier to move the selector lever from position **P**.

If, while the vehicle is moving, the selector lever is accidentally moved to position **N**, release the accelerator and wait for the engine to idle before moving it back into position.



WARNING

- Never press the accelerator when selecting the automatic gearbox operating mode when the vehicle is stationary. Risk of accident!
- Never move the selector lever to positions **R** or **P** when driving. Risk of accident!
- If the vehicle is to be stopped with a gear selected and the engine idling (e.g. waiting or moving slowly at traffic lights), press down on the brake pedal because the transmission is not entirely interrupted when the engine is idling and the vehicle will tend to start moving.
- Apply the handbrake firmly and put the selector lever in position **P** before opening the bonnet and working on the vehicle with the engine running. Risk of accident! Strictly follow the safety instructions »» page 244, Engine compartment.
- When stopping on a slope (hill), try not to stop the vehicle from moving by pressing the “accelerator” with a gear selected.

This could overheat the clutch. If the clutch risks being burnt due to this force, it would switch off and the vehicle could move backwards. Risk of accident!

- If you have to stop on a hill, press down on the brake pedal to stop the vehicle from moving.
- The drive wheels could lose traction on a slippery road surface when the kick-down function is activated. Risk of sliding!

CAUTION

- In DSG automatic gearboxes, the double clutch is protected from overloads. If the hill hold control is used, the clutches are subjected to greater force if the vehicle is at a standstill on a slope or suddenly accelerating on a slope.
- Should the clutches overheat, the  symbol is shown on the informative display with a warning message Gear overheated. Stop! Instruction Manual! An audible warning is also heard. Stop the vehicle in this case, stop the engine and wait until the symbol  has switched off. Danger of damage to the gearbox! You can continue driving once the symbol is switched off.

Control lamps

It lights up green

The brake pedal is not engaged. To select a range of gears, press the brake pedal.

Flashes green

The interlock button on the selector lever is not pressed. Movement of the vehicle is prevented. Engage the selector lever lock.

Starting and driving

Starting

- Press and hold the brake pedal.
- Press and hold the interlock button on the selector lever knob and move the selector lever to position **»»** page 205 before releasing the interlock button.
- Release the brake and press the accelerator.

Stopping

- The selector lever does not have to be moved to position **N** if the vehicle is stopped for a short period, e.g. at intersections. It is enough to step on the brake pedal. However, the engine must remain idling.

Parking

- Press the brake pedal.
- Apply the handbrake.
- Press the interlock button, move the selector lever to position **P** and release the button.

Kick-down feature

The kick-down feature allows maximum acceleration to be reached.

In any gear programme, press down fully on the accelerator for the automatic gearbox to activate the kick-down feature. This function takes priority over the gear programmes without taking into account the position of the selector lever (**D**, **S** or **Tiptronic**) and is used to reach maximum acceleration, using full engine power. Depending on the road speed and engine speed, the automatic gearbox shifts down and the vehicle accelerates. It only shifts up after the maximum engine speed has been reached.

Selector lever positions

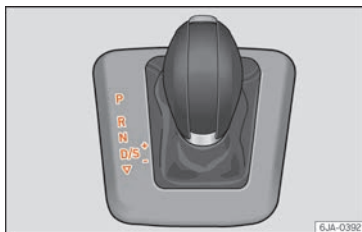

Fig. 216 Gear selector lever



Fig. 217 Information display: selector lever positions.

Read the additional information carefully

» page 36

The current position of the selector lever is shown on the general instrument panel display » **Fig. 217**.

P – Parking position

In this position, the driven wheels are mechanically locked.

The parking position can only be selected when the vehicle is stationary.

If you want to move the selector lever from this position, press the interlock button on the selector lever knob while pressing down on the brake pedal.

If the battery is drained, the selector lever cannot be moved from position **P**.

R – Reverse gear

Reverse gear must be engaged only when the vehicle is stationary and the engine is idling.

To move the selector lever to position **R** from positions **P** or **N**, press the interlock button on the selector lever knob and press down on the brake pedal.

The reverse lights come on when the selector lever is in position **R** and the ignition is on.

N – Neutral (idling)

Neutral (idling) is engaged in this position.

To move the selector lever from position **N** (if the lever has remained in this position for more than 2 seconds) to position **D** or **R** at speeds of less than 5 km/h (3 mph) and when »

the vehicle is stationary, press down on the brake pedal.

D/S – Permanent drive (forward) position

The selector lever in the D/S position enables the gears to be controlled in normal mode (D) or Sport (S) mode. To select Sport mode (S), move the selector lever backwards. Moving the lever again will select normal mode (D). The selected driving mode is shown on the instrument panel display.

In **normal mode** (D), the gearbox automatically selects the best gear ratio. This depends on the engine load, the road speed and the dynamic gear control programme (DCP).

Sport mode (S) must be selected for a sporty driving style. This setting makes use of the engine's maximum power output. When accelerating the gear shifts will be noticeable.

Press the brake pedal to move the selector lever from N to D/S when the vehicle is stationary or at speeds below 3 km/h (2 mph) » **▲ in Basic information on page 204.**

Under certain circumstances (e.g. when driving in mountains) it can be advantageous to switch temporarily to tiptronic mode » **page 206**, in order to *manually select* gear ratios to suit the driving conditions.

Tiptronic gearbox

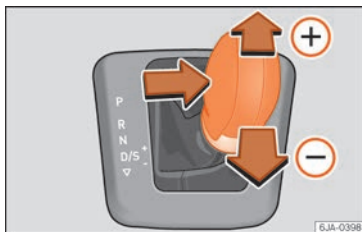

Fig. 218 Selector lever: Tiptronic.

The Tiptronic gearbox allows the driver to change gears manually using the selector lever.

Activating the manual gearbox

- From position **D**, push the selector lever to the right. The selected position of the selector lever is shown on the general instrument panel display together with the gear engaged ① » **Fig. 217.**

Shifting up

- Push the selector lever gently forwards **+** » **Fig. 218.**

Shifting down

- Push the selector lever gently backwards **-** » **Fig. 218.**

The manual gearbox can be activated when the vehicle is either moving or stationary.

When accelerating, the gearbox automatically shifts up shortly before the maximum engine speed is reached.

On shifting up, the gear is only engaged when there is no risk of engine damage.

When the accelerator pedal is pressed down to the kick-down zone, the gearbox will shift down in line with the road speed and engine speed.

i Note

The kick-down function is also available in manual shift mode.

Selector lever lock

Automatic selector lever lock **🔒**

The selector lever is locked in the positions **P** and **N** when the ignition is on. Press the brake pedal to unlock it. Remember, if the selector lever is in positions **P** and **N**, the warning lamp **🔒** will light up on the general instrument panel.

When the selector lever merely moves through position **N** (e.g. when moved from **R** to **D**), the lever lock is not applied. This makes it possible, for example, to rock a stuck vehicle backwards and forwards. The lock is only

applied if the brake is not pressed and the selector lever is moved to position **N** for more than 2 seconds.

The selector lever only locks when the vehicle is stationary or driving at a speed lower than 5 km/h (3 mph). At a higher speed, it automatically disconnects in the **N** position.

Interlock button

The interlock button on the selector lever knob prevents the driver from inadvertently engaging a gear. Press the button to unlock the selector lever.

Safety interlock for ignition key¹⁾

After switching the ignition off, the ignition key can be removed only when the selector lever is in position **P**. If the key is not in the ignition, the selector lever is locked in position **P**.

Driving programmes

Your vehicle is equipped with an electronically-controlled automatic gearbox. Shifting up or down depends on the programme selected.

For a **calm driving style**, the gearbox uses the most economic programme. The gearbox

shifts up as quickly as possible and shifts down as late as possible, thus increasing driving economy.

With a **sporty driving style**, characterised by sudden acceleration, heavy acceleration, speeds that often increase and decrease and maximum speed, the gearbox adapts to this driving style when the accelerator is pressed down fully (kick-down) by shifting down as quickly as possible and can even shift down by several gears at once.

Selecting the best driving programmes is an endless job. Regardless of this, the driver can also make the gearbox switch to a more dynamic gear shift programme by pressing the accelerator quickly. This makes the automatic gearbox shift down into a lower gear than the one that would normally apply to the current speed, allowing for more rapid acceleration (e.g. to overtake another vehicle) without having to press the accelerator until the kick-down position. On shifting up in a corresponding driving style, the gearbox returns to the original programme.

When driving along mountain roads, the gearbox adapts to the gradients. This avoids having to frequently change gears when driving uphill. In Tiptronic mode, it is possible to shift down manually when driving downhill to use the braking effect of the engine.

Emergency program

A back-up programme exists in case of faults.

In the event of a fault in the gearbox electronics, it will continue to work in one of the corresponding back-up programmes. All segments of the screen are lit up or switched off.

The fault can be seen as follows:

- The gearbox only engages certain gears
- Reverse gear **R** cannot be engaged
- The manual gearbox switches off in the back-up programme

Note

If the gearbox switches to the back-up programme, visit an Authorised Service as soon as possible to solve the problem.

Gearbox malfunctions

⚠ Gearbox: Fault! Stop the vehicle and place the lever in the position P.

There is a fault in the gearbox. Stop the vehicle in a safe place and do not continue driving. Seek specialist assistance. »

¹⁾ Valid only for certain countries.

ⓘ **Gearbox: System fault! You may continue driving.**

Have the fault corrected by a specialised workshop without delay.

ⓘ **Gearbox: System fault! You can continue driving with restrictions. Reverse gear disabled**

Take the vehicle to a specialised workshop and have the fault repaired without delay.

ⓘ **Gearbox: System fault! You can continue driving in D until switching off the engine**

Stop the vehicle in a safe place well away from moving traffic. Seek specialist assistance.

ⓘ **Gearbox: too hot. Adapt your driving accordingly**

Continue driving at moderate speeds. When the warning lamp switches off, you can continue driving in a normal manner.

ⓘ **Gearbox: press the brake and engage a gear again.**

If the fault was caused by a gearbox with a high temperature, this driver message will be displayed when the gearbox has cooled again.

Gear-change indicator

Choosing the ideal gear

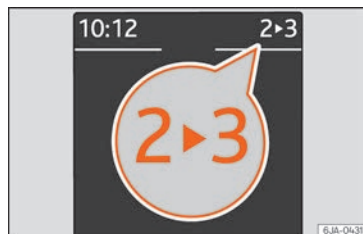

Fig. 219 Instrument panel: gear-change indicator (manual gearbox).

A gear change will be recommended if the gear you are in is not the most economical choice. If no gear-change is recommended, it means that you are already in the most economical gear.

Vehicles with a manual gearbox

The following display symbols »»» **Fig. 219** mean:

- ▶ **Changing to a higher gear:** the suggested gear appears to the **right** of the current gear when a **higher gear is recommended**.
- ◀ **Changing to a lower gear:** the suggested gear appears to the **left** of the current gear when a **lower gear is recommended**.

The gear recommendation may occasionally skip a gear (2nd ▶ 4th).

Vehicles with an automatic gearbox*

The display is only visible in tiptronic mode »» page 206.

The following display symbols mean:

- ↑ **Shifting up a gear**
- ↓ **Shifting down a gear**

ⓘ CAUTION

The gear-change indicator is intended to help save fuel, but it is not intended to recommend the right gear for all driving situations. In certain situations, only the driver can choose the correct gear (for instance when overtaking, driving up a steep gradient or towing a trailer).

ⓘ Note

The display disappears from the instrument panel when you press the clutch pedal.

Steering

Information relating to vehicle steering

Electro-mechanical power steering assists the driver when steering.

Electro-mechanical power steering adapts *electronically* to the speed of the car, torque and turning angle.

If the power steering should fail at any time or the engine is switched off (for instance when being towed), the car can still be steered, as long as the key remains in the ignition. However, more effort than normal will be required to turn the steering wheel.

WARNING

If the power steering does not work, you will need much more strength to turn the wheel. This has a considerable effect on vehicle safety.

- The power steering only works when the engine is running.
- Never allow the vehicle to move when the engine is switched off.
- Never remove the key from the ignition while the vehicle is moving. The steering lock could be engaged and vehicle steering would not work.

CAUTION

Turning the steering wheel fully in either direction when the vehicle is stationary and the engine is in gear puts the electromechanical steering under great stress. This could lead to noise. Never leave the steering wheel turned fully in either direction for more than 15 seconds. Risk of damage to the electromechanical steering system!

Note

The ignition of the vehicle being towed must be switched on to prevent the steering wheel from locking and also to allow the use of the turn signals, horn, windscreen wipers and washers.

Control lamp

It lights up red

The electromechanical steering is damaged. **Do not continue driving.** Stop the vehicle safely and as soon as possible. Have the steering checked immediately by a specialised workshop.

It lights up yellow

The operation of the electromechanical steering is limited. See a specialised workshop immediately and have the steering checked. If the yellow warning lamp does not light up again after the engine is restarted and the vehicle has travelled a short distance, you do **not** need to take it to a specialised workshop.

Or: The 12-volt battery was disconnected and has been connected again. Drive for a short time at 15-20 km/h (9-12 mph).

It flashes yellow

The steering column is tight. Turn the wheel a little to both sides.

Or: Not unlocked or blocked steering column. Remove the key from the ignition and then switch the ignition back on. If necessary, check the messages displayed on the instrument panel display. **Do not drive on if** the steering column remains locked after the ignition has been switched on. Seek specialist assistance.

The control lamp should light up for a few seconds when the ignition is switched on. It should go out once the engine is started.

WARNING

If the warning lamps and the corresponding messages are ignored when they light up, the vehicle may stall in traffic. It could cause »

damage to the vehicle and cause accidents and severe injuries.

- Never ignore the warning lamps or messages.
- Stop the vehicle at the next opportunity and in a safe place.

Run-in and economical driving

The first 1,500 km

Over the first 1,500 kilometres the engine must be run in.

Up to 1000 kilometres

- Do not drive at more than 3/4 of the maximum speed corresponding to the engaged gear, i.e. up to 3/4 of the maximum permitted engine speed.
- Do not drive at full speed.
- Avoid high engine speeds.
- Do not tow a trailer.

From 1000 to 1500 kilometres (600 to 900 miles)

- **Slowly** increase the engine speed until reaching the maximum permitted speed of

the engaged gear, i.e. the maximum permitted engine speed.

During its first few hours of running, the internal friction in the engine is greater than later on, when all the moving parts have bedded in. How the vehicle is driven over approximately the first 1,500 kilometres (900 miles), determines the success of the process of running in the engine.

Even after running in, the vehicle should not be unnecessarily driven at **high engine speeds**. The maximum permitted engine speed is marked at the start of the red zone on the rev counter dial. The gear must be changed up when the red area is reached in vehicles with a manual gearbox. **Extremely** high engine speeds when accelerating are automatically limited, however the engine is not protected against high engine speeds produced by incorrectly changing to a lower gear, which could cause the engine to run at revs above the maximum permitted amount, and consequently result in damage to the engine.

Additionally, vehicles with a manual gearbox must also bear the following in mind: do not drive at excessively **low** speeds. Change down to a lower gear when the engine no longer runs smoothly. Observe the recommendations for changing gear »» page 208.

New tyres

New tyres must be submitted to "running in", given that initially their grip is not yet at the maximum level. During the first 500 km (120 miles) drive very carefully.

New brake pads

New brake pads do not yet provide maximum friction capacity. First they must be "run in". During the first 200 km (120 miles) drive very carefully.

ⓘ CAUTION

All the information for speed and engine speed refers to an engine that operates at operating temperature. Do not run the engine at high engine speeds, neither when stopped or while driving.

🌱 For the sake of the environment

Do not drive at unnecessarily high engine speeds; changing to a higher gear sooner contributes to saving fuel, reduces operating noise and protects the environment.

Environmental compatibility

Environmental protection is a top priority in the design, choice of materials and manufacture of your new SEAT.

Constructive measures to encourage recycling

- Joints and connections designed for easy dismantling.
- Modular construction to facilitate dismantling.
- Increased use of single-grade materials.
- Plastic parts and elastomers are marked in accordance with ISO 1043, ISO 11469 and ISO 1629.

Choice of materials

- Use of recycled materials.
- Use of compatible plastics in the same part if its components are not easily separated.
- Use of recycled materials and/or materials originating from renewable sources.
- Reduction of volatile components, including odour, in plastic materials.
- Use of CFC-free coolants.

Ban on heavy metals, with the exceptions dictated by law (Annex II of ELV Directive 2000/53/EC): cadmium, lead, mercury, hexavalent chromium.

Manufacturing methods

- Reduction of the quantity of thinner in the protective wax for cavities.
- Use of plastic film as protection during vehicle transport.

- Use of solvent-free adhesives.
- Use of CFC-free coolants in cooling systems.
- Recycling and energy recovery from residues (RDF).
- Improvement in the quality of waste water.
- Use of systems for the recovery of residual heat (thermal recovery, enthalpy wheels, etc.).
- The use of water-soluble paints.

Economical and environmentally-friendly driving

Fuel consumption, environmental pollution and wear to the engine, brakes and tyres depends in large part on your driving style. By adopting an economical driving style and anticipating the traffic situation ahead, you can easily reduce fuel consumption by 10-15%. Some tips on how to help you reduce pollution while saving money are listed below.

Drive anticipating the traffic situation

A vehicle uses most fuel when accelerating. When you anticipate situations, you have to brake less often and, thus, accelerate less. If it is possible, let the vehicle roll with a **gear engaged**, for example, if you see a red light ahead. The braking effect achieved in this way helps to reduce the wear of brakes and

tyres; emissions and fuel consumption are reduced to zero (disconnection due to inertia).

Change gear early to save energy

An effective way of saving fuel is to change up *quickly* through the gears. Running the engine at high rpm in the lower gears uses an unnecessary amount of fuel.

Manual transmission: shift up from first to second gear as soon as possible. We recommend that, whenever possible, you change to a higher gear upon reaching 2000 rpm. Follow the "recommended gear" indication that appears on the instrument panel » page 208.

Avoid driving at high speed

We advise you not to drive at the top speed permitted by the vehicle. Fuel consumption, exhaust emissions and noise levels all increase very rapidly at higher speeds. Driving at moderate speeds will help to save fuel.

Avoid idling

It is worthwhile switching off the engine when waiting in a traffic jam, at level crossings or at traffic lights with a long red phase. The fuel saved after only 30 - 40 seconds is greater than the amount of fuel needed to restart the engine.

The engine takes a long time to warm up when it is idling. Mechanical wear and



pollutant emissions are also especially high during this initial warm-up phase. It is therefore best to drive off immediately after starting the engine. Avoid running the engine at high speed.

Periodic maintenance

Periodic maintenance work guarantees that, before beginning a journey, you will not consume more than the required amount of fuel. A well-serviced engine gives you the benefit of **improved fuel efficiency** as well as maximum reliability and an enhanced resale value.

A badly serviced engine can consume up to 10% more fuel than necessary.

Avoid short journeys

To reduce the consumption and emission of polluting exhaust gases, the engine and the exhaust gas filtration systems should reach the optimum **operating temperature**.

With the engine cold, fuel consumption is proportionally higher. The engine does not warm up and fuel consumption does not normalise until having driven approximately *four* kilometres [2.5 miles]. This is why we recommend avoiding short trips whenever possible.

Maintain the correct tyre pressures

Bear in mind that keeping the tyres at an adequate pressure saves fuel. If the tyre pressure

is just one bar [14.5 psi/100 kPa] too low, fuel consumption can increase by as much as 5%. Due to the greater rolling resistance, underinflation also increases tyre **wear** and impairs handling.

The tyre pressures should always be checked when the tyres are *cold*.

Do not use **winter tyres** all year round as they increase fuel consumption by up to 10%.

Avoid unnecessary weight

Given that every kilo of **extra weight** will increase the fuel consumption, it is advisable to always check the luggage compartment to make sure that no unnecessary loads are being transported.

A roof rack is often left in place for the sake of convenience, even when it is no longer needed. At a speed of 100 km/h [62 mph] and 120 km/h [75 mph] your vehicle will use about 12% more fuel as a result of the extra wind resistance caused by the roof rack even when it is not in use.

Save electricity

The engine activates the alternator, which produces electricity. With the need for electricity, fuel consumption also increases. Because of this, always turn off electrical devices when you do not need them. Examples of devices that use a lot of electricity are: the

fan at high speeds, the rear window heating and the seat heaters*.

Note

- If your vehicle has **Start-Stop**, it is not recommended to switch this function off.
- It is recommended that you **close the windows when driving at more than 60 km/h (37 mph)**.
- Do not drive with your foot resting on the **clutch pedal**, as the pressure can make the plate spin, more fuel will be used and it can burn the clutch plate lining, causing a serious fault.
- Do not hold the vehicle on a hill with the clutch, use the foot brake or hand brake, using the latter to start. The fuel consumption will be lower and you will prevent the clutch plate from being damaged.
- On descents, use the engine brake, changing to the gear that is more suitable for the slope. Fuel consumption will be “zero” and the brakes will not suffer.

Engine management and emission control system

Introduction

WARNING

- Because of the high temperatures which can occur in the exhaust purification system (catalytic converter or diesel particulate filter), do not park the vehicle where the exhaust can come into contact with flammable materials under the car (e.g. on grass or at the forest edge). Fire hazard!
- Do not apply wax underneath the vehicle around the area of the exhaust system: Fire hazard!

Control lamps

It lights up

Fault in the emission control system. (e.g. faulty lambda sensor).
Reduce speed and drive carefully to the nearest specialised workshop to have the engine checked.

Flashes

Combustion fault which could damage the catalytic converter.
Reduce speed and drive carefully to the nearest specialised workshop to have the engine checked.

It lights up

Particulate filter blocked »» page 214.

EPC It lights up

Fault in the management of the petrol engine. Have the engine checked by a specialised workshop as soon as possible.

The warning lamp **EPC** (Electronic Power Control) lights up when the ignition is switched on while system operation is being verified. It should go out once the engine is started.



It lights up

Diesel engine glow plug system.
The engine glow plug system has been activated. The engine can be started straight away when the lamp switches off.

Flashes

Fault in the management of the diesel engine. Have the engine checked by a specialised workshop as soon as possible.

Note

While the control lamps are on , , **EPC** or  there might be faults in the engine, fuel consumption may go up and the engine might lose power.

Catalytic converter

✓ Applies to vehicles with petrol engine

To maintain the useful life of the catalytic converter

- Use only unleaded petrol with petrol engines, as lead damages the catalytic converter.
- Do not let the fuel get too low in the tank.
- For engine oil changes, do not replenish with too much engine oil »» page 247.
- Never tow the vehicle to start it, use jump leads if necessary »»  page 54.

If you notice misfiring, uneven running or loss of power when the vehicle is moving, reduce speed immediately and have the vehicle inspected at the nearest specialised workshop. In general, the exhaust warning lamp will light up when any of the described symptoms occur »» page 213. If this happens, unburnt fuel can enter the exhaust system and escape into the environment. The catalytic converter can also be damaged by overheating.

CAUTION

Never run the fuel tank completely dry because the irregularity of the fuel supply may cause ignition problems. This allows unburnt fuel to enter the exhaust system, which could cause overheating and damage the catalytic converter.

»

For the sake of the environment

Even when the emission control system is working perfectly, there may be a smell of sulphur from the exhaust gas under some conditions. This depends on the sulphur content of the fuel used. Quite often the problem can be solved by changing to another brand of fuel.

Particulate filter

✓ Applies to vehicles with diesel engine

The diesel engine particulate filter eliminates most of the soot from the exhaust gas system. Under normal driving conditions, the filter cleans itself. The particulate filter is cleaned automatically without need for indication by the warning lamp . This may be noticed because the engine idle speed increases and an odour may be detected.

If automatic filter purification cannot be carried out (because only short trips are taken, for example), soot will accumulate on the filter and the particulate filter warning lamp will  switch on.

Facilitate the automatic filter cleaning process by driving in the following manner:

- Drive for approximately 15 minutes at a minimum speed of 60 km/h (37 mph) in 4th or 5th gear (automatic gearbox: S gear range).

- Maintain the engine speed at approximately 2,000 rpm.

The rise in temperature causes the soot on the filter to burn. On completion of the cleaning the warning lamp will switch off. If the warning lamp does not switch off, go immediately to a specialised workshop to rectify the problem.

CAUTION

While the warning lamp  is lit up, the fuel consumption is high, and in certain conditions, the engine power is reduced.

Note

- In order for the particulate filter to burn off soot in a correct manner, avoid carrying out frequent short journeys.
- Using diesel fuel with a high sulphur count can considerably reduce the useful life of the particulate filter. The specialised service provides information about the countries where fuel with a high sulphur content is used.

Driving tips

Driving through flooded roads

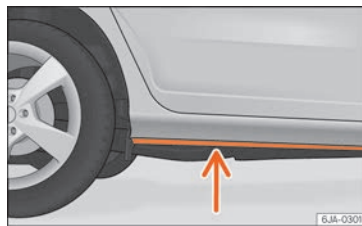

Fig. 220 Driving through water.

To prevent the vehicle from being damaged when driving through water (i.e. flooded roads), please observe the following:

- Determine the depth of the water before entering. Water can reach a maximum height of below the door sill **» Fig. 220**.
- Drive at a maximum pace of walking speed. Driving at a higher speed can cause a wave in front of the vehicle, which can cause water to enter the engine air intake system or other parts of the vehicle.
- Never stop in the water, never reverse and never stop the engine.
- Before driving through water deactivate the Start-Stop system **»» page 215**.

⚠ WARNING

- Driving through water, dirt and mud can reduce braking capability and prolong the braking distance – Risk of accident!
- Do not carry out any sudden or strong braking manoeuvres after driving through water.
- Clean and dry the brakes as soon as possible after driving through water by breaking intermittently. Carry out braking in order to dry the brakes and clean the brake discs only if traffic so permits. Do not put other drivers at risk.

ⓘ CAUTION

- In the event of driving through water, parts of the vehicle can be seriously damaged, such as the engine, gearbox, catalytic converter, suspension or the electrical system.
- Oncoming vehicles that drive through water can cause waves that exceed your vehicle's permitted level for driving through water.
- There may be pot-holes mud or rocks under the water that can hinder or prevent driving through water.
- Do not drive through salt water. The salt can cause rust. All components that are exposed to salt water must be rinsed immediately with fresh water.

ⓘ Note

After driving through water we recommend that you contact a specialised service for an inspection.

Preventing damage to the vehicle

In order to prevent damage to the vehicle, take special care:

- on roads that are in poor condition,
- when mounting kerbs,
- when approaching very steep ramps, etc.,
- with the parts of the vehicle situated on the lower part of the vehicle, i.e. the spoiler, the exhaust pipe.

This applies especially to vehicles with a very low suspension (sport) and when the vehicle is fully loaded.

Driver assistance systems**Start-Stop system*****Control lamps****(A) It lights up**

The Start-Stop system is available, the automatic engine shutdown is active.

(A) It lights up

The Start-Stop system is not available.

Description and operation

Fig. 221 Instrument panel: Start-stop button.

The Start-Stop system helps save fuel and reduce harmful and CO₂ emissions. »

The system is automatically switched on every time the ignition is switched on.

The system automatically switches off the engine when the vehicle is stationary, e.g. waiting at traffic lights.

The current status of the Start-Stop system is displayed on the general instrument panel display.

Automatic engine shut down (Stop phase)

- Stop the vehicle (if necessary using the handbrake).
- Shift to neutral.
- Release the clutch pedal.

Automatic engine start up (Start phase)

- Press the clutch.

Switching the Start-Stop system on and off

The Start-Stop system can be switched on and off by pressing the A_{OFF} button
»» Fig. 221.

The warning lamp in the button will light up when the system is switched off.

If the vehicle is in Stop phase when the button is pressed, the engine will start immediately.

The Start-Stop system works under complex driving conditions that are difficult to detect without specialist technology. The set of nec-

essary conditions for the correct operating of the Start-Stop system are indicated below.

Conditions for automatic engine shut down (Stop phase)

- Selector lever in neutral.
- Clutch pedal not pressed.
- Driver with seat belt fastened.
- Driver door closed.
- The bonnet closed.
- Vehicle stationary.
- The factory-fitted towing bracket is not electrically connected to a trailer.
- Engine at operating temperature.
- Vehicle's battery sufficiently charged.
- Vehicle not on a very steep slope
- Engine speed below 1,200 rpm.
- Vehicle battery temperature is neither too high nor too low.
- Sufficient brake system pressure.
- Difference between outside temperature and set interior temperature not too great
- Vehicle speed since the last time the engine started was above 3 km/h [2 mph).
- Particulate filter not being cleaned
»» page 214.
- Front wheels not overly turned (steering wheel turned less than three quarters of a turn)

Conditions for engine start up (Start phase)

- Clutch pedal pressed.
- Max./min. temperature set.
- Windscreen defrost function switched on.
- High blower speed.
- Start-Stop button pressed.

Conditions for automatic engine start up without driver involvement

- Vehicle moving at a speed of over 3 km/h [2 mph).
- Difference between outside temperature and interior temperature is too great
- Vehicle's battery insufficiently charged.
- Insufficient brake system pressure.

If the driver seat belt is unfastened for more than 30 seconds in Stop phase, the engine must be started using the ignition key. Please observe the messages on the general instrument panel display.

Warnings on the instrument panel display (valid for vehicles not fitted with an informative display)

FAULT: Start-Stop	Fault in the Start-Stop system
START-STOP IMPOS-SIBLE	Engine cannot be automatically shut down

START-STOP ACTIVE	Automatic engine shut down (Stop phase)
SWITCH OFF IGNITION	Switch the ignition off
START MANUALLY	Start the engine manually

WARNING

- If the engine is switched off, neither the brake servo nor the power steering will work.
- Do not move the vehicle when the engine is switched off.

CAUTION

Switch off the Start-Stop system
»» page 214 before driving through a pool of water on the road.

Note

- The battery temperature may reflect changes in outside temperature after several hours. If the vehicle has been stopped outside at temperatures below zero or in direct sunlight, for example, the battery temperature may take several hours to reach the values required for the correct operating of the Start-Stop system.
- If the Climatronic system is operating automatically, this could impair automatic engine shut down under certain conditions.

Cruise control (CCS)***Control lamp****It lights up green**

The Cruise Control System (GRA) is switched on and active.

Several warning and control lamps light up for a few seconds when the ignition is switched on, signalling that the function is being verified. They will switch off after a few seconds.

WARNING

Observe the safety warnings »» in Control and warning lamps on page 103.

Cruise control operation

Fig. 222 Turn signal and main beam headlight lever: cruise control buttons.

Read the additional information carefully
»» page 34

The cruise control system allows you to drive at a constant speed of 30 km/h (19 mph) or higher without having to press the accelerator. However, the speed is only maintained within the margin permitted by the engine power and the braking effect of the engine.

Setting speed

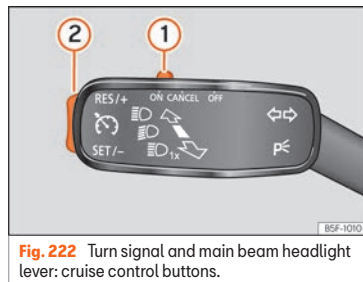
- Move knob **1** »» **Fig. 222** to the **ON** position.
- Briefly press rocker switch **2** in **SET** position when you have reached the speed you wish to set. »

On releasing rocker switch ② from **SET**, the current speed is stored and will remain constant without having to press the accelerator pedal.

Increasing speed by pressing the accelerator pedal

- Press the accelerator to increase the speed of the vehicle.
- Release the accelerator and the previously programmed speed will be resumed.

If, when pressing the accelerator, the vehicle exceeds the programmed speed by more than 10 km/h (6 mph) for more than 3 minutes, the set speed will be deleted. The speed will have to be stored again.

Increasing speed by pressing switch ②

- Press rocker switch ② »» Fig. 222 »» page 217 in position **RES**.
- If the button is held down in the **RES** position, the speed increases continuously. Release the switch when the required speed is reached. The speed is stored.

Setting a lower speed

- The set speed can be **reduced** by pressing switch ② »» Fig. 222 »» page 217 in **SET**.
- If the button is held down in the **SET** position, the speed decreases continuously. Release

the switch when the required speed is reached. The speed is stored.

- On releasing the switch at speeds of less than 30 km/h (19 mph), no speed will be set and the memory will be deleted. The vehicle must be moving at a speed of over 30 km/h (19 mph) and switch ② pressed again to **SET** for it to be set.

The speed can be reduced by pressing the brake pedal, which temporarily switches off the cruise control.

Temporary deactivation of cruise control

Cruise control is **switched off temporarily** by pressing switch ① »» Fig. 222 »» page 217 in **CANCEL** or by pressing the brake or clutch pedal.

The set speed is stored.

To **recover** the set speed, briefly press the button ② in **RES** position once you have released the brake pedal.

Turning off the cruise control system

- Move knob ① »» Fig. 222 »» page 217 to the **OFF** position.

⚠ WARNING

- For safety reasons the cruise control system must not be used in dense traffic or where roads conditions are poor (e.g. due

to ice, aquaplaning, loose grit, snow) - Risk of accident!

- The programmed speed can only be re-established if it is not too high for current traffic conditions.
- Always switch the cruise control system off after using it in order to avoid involuntary use.

ⓘ CAUTION

- The cruise control cannot maintain a constant speed when the vehicle is moving downhill. The vehicle tends to accelerate under its own weight. Therefore, shift down or use the brake pedal in good time to slow the vehicle.

ⓘ Note

- In vehicles with an automatic gearbox, the cruise control system cannot be switched on if the selector lever is in position P, N or R.
- In vehicles with a manual gearbox, the cruise control cannot be switched on if first gear or reverse gear is engaged.

Emergency braking assistance system (Front Assist)*

Topic introduction



Fig. 223 On the instrument panel display: advance warning indications.

The objective of the emergency braking assistance system is to prevent head-on collisions against objects that may be in the vehicle's path or minimise the consequences of such impacts.

Within the limitations imposed by the environmental conditions and by the system itself, the function acts in staggered fashion, depending on how critical the situation is. Initially it warns the driver, and if the driver's reaction does not occur or is insufficient, it activates an independent emergency braking.

The function is intended to prevent collisions with parked vehicles or vehicles in the same

lane travelling in the same direction. It may fail to activate in other danger situations.

The Front Assist function is active within a range of speeds between 4 km/h (2.5 mph) and 250 km/h (156 mph). Depending on speed, traffic conditions and driver behaviour, some of the sub-functions described below are omitted in order to optimise the system's general behaviour.

The Front Assist is a driving assistance function that can never replace the driver's attention.

Safety distance warning

If the system detects a situation of danger because the vehicle is too close to the vehicle ahead, it will warn the driver by means of an indication on the instrument panel display .

The timing of the warning varies depending on driver behaviour and the traffic situation.

Advance warning

If the system detects a possible collision with the vehicle in front, it may alert the driver by means of an audible warning and an indication on the instrument panel display **»» Fig. 223.**

The warning moment varies depending on the traffic situation and driver behaviour. At

the same time, the vehicle will prepare for a possible emergency braking **»»** .

Critical warning

If the driver fails to react to the pre-warning (advance warning), the system may actively intervene in the brakes and generate a brief jolt to warn the driver of the imminent danger of a collision.

Automatic braking

If the driver also fails to react to the critical warning, the system may initiate independent emergency braking by progressively increasing the braking effect in accordance with how critical the situation is.

Driver emergency braking assistance system

Faced with an imminent collision, the system may detect that the driver is not braking hard enough to avoid the collision. In this case, it will automatically increase the braking effect.

Due to certain driving circumstances and the limitations of its operation, there are some cases in which the system cannot prevent a collision, although it can significantly minimise the consequences by reducing the speed and the force of the impact. **»»**

⚠ WARNING

Observe the safety warnings »» ⚠ in Control and warning lamps on page 103.

⚠ WARNING

The Front Assist system cannot change the laws of physics or replace the driver in terms of keeping control of the vehicle and reacting to a possible emergency situation.

⚠ WARNING

Following a Front Assist emergency warning, pay immediate attention to the situation and try to avoid the collision by braking or by dodging the obstacle, as applicable.

- If the Front Assist does not work as described in this chapter (e.g. it repeatedly intervenes unnecessarily), switch it off.
- Adapt your speed and safe distance to the vehicle in front of you at all times to suit visibility, weather, road and traffic conditions.
- The Front Assist alone cannot avoid accidents and serious injuries.
- In complex driving situations, occasionally the Front Assist may issue warnings and intervene in braking unnecessarily, for example at traffic islands.
- If the operation of the Front Assist is impaired, for example, by dirt or because the radar sensor has lost its settings, the sys-

tem may issue unnecessary warnings and intervene inopportunistly in the braking.

- The Front Assist does not react to animals or vehicles crossing your path or approaching head-on down the same lane.
- The Front Assist does not react to pedestrians walking in the same direction or approaching head-on down the same lane.
- The driver must always be ready to take over the control of the vehicle.

i Note

- When the Front Assist is connected, the indications on the instrument panel screen may be concealed by warnings from other functions, such as an incoming call.
- When the Front Assist causes a braking, the brake pedal is "harder".
- Automatic interventions by the Front Assist on the brakes may be interrupted by pressing the clutch, accelerator or moving the wheel.
- The Front Assist may brake the vehicle until it stops completely. However, the brake system does not halt the vehicle permanently. Use the foot brake!
- If the Front Assist does not work as described in this chapter (e.g. in intervenes several times unnecessarily), switch it off. Have the system checked by a specialised workshop. SEAT recommends visiting a SEAT dealership.

Radar sensor

Fig. 224 On the front bumper: radar sensor.

A radar sensor is installed on the front bumper to determine the traffic situation

»» **Fig. 224** ①.

The radar sensor's visibility may be impaired by dirt, mud or snow, or by environmental influences such as rain or mist. In this case, the Front Assist does not work. The instrument panel displays the following message: **Front Assist: No sensor vision!** If necessary clean the radar sensor »» ①.

When the radar sensor begins to operate properly again, the Front Assist will automatically be available again. The message will disappear from the instrument panel display.

Front Assist operation may be affected by a strong radar reverse reflection. This may occur, for example, in a closed car park or due

to the presence of metallic objects (e.g. rails on the road or sheets used in road works).

The area in front of and around the radar sensor should not be covered with adhesives, additional or similar headlights, as this may negatively affect Front Assist operation.

If the front of the vehicle is not properly repaired or structural modifications are made to it, for example if the suspension is lowered, Front Assist operation may be affected. SEAT recommends visiting a SEAT dealership for this purpose.

ⓘ CAUTION

If you have the sensation that the radar sensor is damaged or has lost its settings, disconnect the Front Assist. This will avoid possible dangerous situations caused by a system malfunction. If this occurs have it adjusted.

- The sensor may become damaged or lose its settings when knocked, for example, during a parking manoeuvre. This may compromise the system's efficacy or disconnect it.
- Repairs to the radar sensor require specialist knowledge and special tools. SEAT recommends visiting a SEAT dealership for this purpose.
- A registration plate or plate holder on the front that is larger than the space for the registration plate, or a registration plate

that is curved or warped can cause the radar to malfunction.

- Clean away the snow with a brush and the ice preferably with a solvent-free de-icer spray.

Operating the Emergency braking assistance system (Front Assist)



Fig. 225 On the screen of the instrument panel Front Assist switched off message.

The Front Assist is active whenever the ignition is switched on.

When the Front Assist is switched off, so too are the advance warning function (pre warning) and the distance warning.

SEAT recommends leaving the Front Assist always switched on. Exceptions » page 222, **Switching the Front Assist off temporarily in the following situations.**

Switching the Front Assist on and off

With the ignition switched on, the Front Assist can be switched on and off as follows:

- Select the corresponding menu option using the button for the driver assistance systems » page 27.
- **OR:** switch the system on and off in Easy Connect using the **(CAR)** button **(SETTINGS)** button and **(Driver assistance button)** » page 24.

When Front Assist is switched off, the instrument panel will inform that it has been switched off with the following indicator » **Fig. 225.**

Activating or deactivating the pre-warning (advance warning)

The pre-warning function (advance warning) can be switched on or off in the Easy Connect system with the **(CAR)** button and the **(SETTINGS)** and **(Driver assistance)** function buttons » page 24.

The system will store the setting for the next time the ignition is switched on.

SEAT recommends keeping the pre-warning function switched on at all times.

Depending on the infotainment system installed in the vehicle, the advance warning function may be adjusted as follows:

- Advance



- Medium
- Delayed
- Deactivated

SEAT recommends driving with the function in "Medium" mode.

Switching distance warning on and off

If the safe distance with regard to the vehicle in front is exceeded, the relevant warning will appear on the instrument panel display . In this case, increase the safe distance.

The distance warning can be switched on and off in the Easy Connect system using the **CAR** button and the **SETTINGS** and **(Driver assistance)** function buttons  **page 24**.

The system will store the setting for the next time the ignition is switched on.

SEAT recommends keeping the distance warning switched on at all times.

Switching the Front Assist off temporarily in the following situations

In the following situations the Front Assist should be deactivated due to the system's limitations:

- When the vehicle is to be towed.

- If the vehicle is on a test bed.
- When the radar sensor is damaged.
- If the radar sensor takes a heavy knock, for example in a rear collision.
- If it intervenes several times unnecessarily.
- If the radar sensor is covered temporarily with some kind of accessory, such as an additional headlight or the like.
- When the vehicle is to be loaded on a lorry, ferry or train.

System limitations

The Front Assist has certain physical limitations inherent to the system. Thus, in certain circumstances, some of the system's reactions may be inopportune from the driver's standpoint. So pay attention in order to intervene if necessary.

The following conditions may cause the Front Assist not to react or to do so too late:

- In the first few instants of driving after switching on the ignition, due to the system's initial auto-calibration.
- On taking tight bends or complex paths.
- Pressing the accelerator all the way down.
- If the Front Assist is switched off or damaged.

- If the ASR has been disconnected or the ESC activated in **Sport** mode manually  **page 201**.

- If the ESC is controlling.
- If several brake lights of the vehicle or electrically connected trailer are damaged.
- If the radar sensor is dirty or covered.
- If there are metal objects, e.g. rails on the road or sheets used in road works.
- If the vehicle is reversing.
- If the vehicle over-accelerates.
- In case of snow or heavy rain.
- In case of narrow vehicles, such as motor-bikes.
- Misaligned vehicles.
- Vehicles crossing the other's path.
- Vehicles approaching in the opposite direction.
- Special loads and accessories of other vehicles that jut out over the sides, backwards or over the top.

Parking aid

General information

Assorted assistance systems – which vary depending on the equipment fitted in the car – will help you when parking or manoeuvring.

The **rear parking aid** is an audible assistant that warns about obstacles located *behind* the vehicle » page 224.

During parking, **Parking System Plus** assists the driver by visually and audibly warning them about obstacles detected *in front* and *behind* the vehicle » page 224.

WARNING

- Always pay attention, also when looking straight ahead, to traffic and the vehicle surroundings. The assistance systems are not a replacement for driver awareness. When inserting or removing the vehicle from a parking space, or when performing similar manoeuvres the driver always assumes the responsibility.
- Adapt your speed and driving style at all times to suit visibility, weather, road and traffic conditions.
- The ultrasound sensors have blind spots in which obstacles and people are not registered. Pay special attention to children and animals.
- Always keep visual control of the surroundings: use the mirrors for additional help.

CAUTION

Parking Aid functions may be negatively affected by different factors that may lead to damage to the vehicle or its immediate surroundings:

- Under certain circumstances, the system does not detect or display certain objects:
 - Objects such as chains, trailer draw bars, fences, posts and thin trees.
 - Objects that are located above the sensors, such as protrusions in a wall.
 - Objects with certain surfaces or structures, such as wire mesh fences or powder snow.
- Certain surfaces of objects and garments do not reflect the ultrasound sensors' signals. The system cannot detect, at least correctly, these objects or people wearing such clothes.
- Ultrasound sensor signals may be affected by external sound sources. In certain circumstances this may prevent them from detecting people or objects.
- Please note that low obstacles detected by the system may no longer be registered by the sensors as the car moves closer, so the system will not give any further warning. In certain circumstances, objects such as high kerbs that could damage the bottom of the vehicle are not detected either.
- If the first warning from the Parking Aid is ignored, the vehicle could suffer considerable damage.
- The knocks or damage on the radiator grille, bumper, wheel arch and vehicle underbody can adjust the orientation of the sensors. This can affect the parking aid

function. Have the function checked by a specialised workshop.

Note

- In certain situations, the system can give a warning even though there is no obstacle in the detected area, e.g:
 - with rough or cobbled floors or ground with long grass;
 - with external ultrasound sources, such as cleaning vehicles or other vehicles;
 - In downpours, intense snow or dense exhaust gases;
 - if the registration plate (front or rear) is not properly affixed to the bumper surface;
 - or in locations such as the brow of a hill.
- In order to guarantee good system operation, keep the ultrasound sensors clean, free of snow or ice, and do not cover them with adhesives or other objects.
- If you use high-pressure or vapour equipment to clean the ultrasound sensors, apply it directly only very briefly and always from a distance of more than 10 cm.
- Retrofitting of accessories to the vehicle, such as a bicycle rack, may interfere with the operation of the Parking Aid.
- In order to familiarise yourself with the system, it is advised that you practice parking in an area or car park that is free from

»

traffic. There must be good weather and light conditions.

- The volume and tone of the warnings can be modified, in addition to the indications »» page 227.
- In vehicles *without* a driver information system, these parameters can be modified in a SEAT Official Service or in a specialised workshop.
- Please observe information on towing a trailer »» page 227.
- The display on the Easy Connect screen shows a slight time delay.

Rear parking aid*

The rear Parking Aid assists the driver in parking by means of audible warning sounds.

Description

There are sensors integrated in the rear bumper. When the sensors detect an obstacle, you are alerted by audible warnings.

Make particularly sure that the sensors are not covered by adhesives, residues and the like, as this could affect the system's operation. Cleaning instructions »» page 267.

The approximate measurement range of the rear sensors is:

side area	0.90 m
central area	1.60 m

As you approach the obstacle, the time interval between the audible warnings will be reduced. When you reach around 0.30 m the warning will be constant: Do not continue to move forward (or backward) »» ⚠ in General information on page 223, »» ⓘ in General information on page 223!

If you maintain separation from the obstacle, the volume of the warning begins to reduce after four seconds (does not affect the tone of the constant warning).

Activating/Deactivating

When engaging reverse gear, the parking aid is automatically switched on. This is confirmed with a short warning.

On disengaging reverse gear, the Parking Aid system is disconnected immediately.

Parking aid plus*

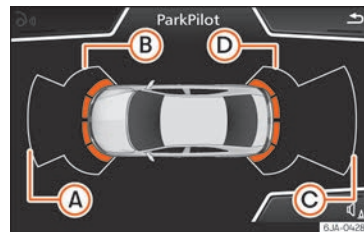

Fig. 226 Represented area.

Parking system plus assists you audibly and visually when parking.

There are sensors integrated in the front and rear bumpers. When they detect an obstacle, you are alerted by audible warnings and visually on the Easy Connect system.

In the event of danger of a frontal collision, the audible warnings come from the front of the vehicle, and in the event of the danger of a rear-end collision they come from the rear.

Make particularly sure that the sensors are not covered by adhesives, residues and the like, as this could affect the system's operation. Cleaning instructions »» page 267.

The approximate measurement range of the sensors is:

- Ⓐ 1.20 m

- B 0.90 m
- C 1.60 m
- D 0.90 m

As you approach the obstacle, the time interval between the audible warnings will be reduced. When you reach around 0.30 m the warning will be constant: do not continue to move forward (or backward)!

If you maintain separation from the obstacle, the volume of the warning begins to reduce after four seconds (does not affect the tone of the constant warning).

Parking aid operation



Fig. 227 Centre console: parking aid button.

Manual connection of Parking Aid

- Press the **P** button *once*.

Manual disconnection of Parking Aid

- Press the **P** button *again*.

Manual disconnection of Parking Aid display (the audible sounds remain active)

- Press a button on the main menu of the factory-assembled infotainment system.
- **OR** press the **BACK** function button.

Automatic connection of Parking Aid

- Engage reverse gear or turn the selector lever to position **R**.
- **OR**: If the vehicle approaches an obstacle that is in its forwards path at a speed below 10 km/h (6 mph) » page 225, **Automatic activation**. The obstacle is detected from a distance of approx. 95 cm if the automatic connection is activated in the infotainment system. A reduced display is shown.

Automatic disconnection of Parking Aid

- Move the selector lever to position **P**.
- **OR**: accelerate to approx. 10 km/h (6 mph) or faster.

Temporary suppression of sound in Parking Aid

- Press the  function button.

Change from reduced view to full view

- Engage reverse gear or turn the selector lever to position **R**.
- **OR**: press the car icon in reduced view.

If necessary, switch to the rear-assist image (Rear View Camera “RVC”)

- Engage reverse gear or turn the selector lever to position **R**.
- **OR** press the **RVC** function button.

A short confirmation signal will be heard and the button symbol will light up yellow when the system is switched on.

Automatic activation



Fig. 228 Miniature indication of automatic activation.

When the Plus Parking Aid connects automatically, a miniature of the vehicle and the »

segments will appear on the left of the display »» Fig. 228.



Automatic activation occurs when slowly approaching an obstacle located in front of the vehicle. It only operates every time the speed is reduced below approximately 10 km/h (6 mph) for the first time.

If the parking aid is switched off using the P_{va} button, the following actions must be carried out in order for it to automatically switch on:

- Switch off the ignition and switch it on again.
- **OR:** accelerate above 10 km/h (6 mph) before reducing speed below this number again.
- **OR:** place the selector lever in position P and then move it from this position.
- **OR:** switch on and off the automatic activation in the Easy Connect system menu.

The automatic activation with parking aid miniature indication can be switched on and off from the Easy Connect system menu

»»  page 24:

- Switch the ignition on.
- Select:  button > **Settings** > **Parking and manoeuvring**.
- Select the **Automatic activation** option. When the function button check box is activated , the function is on.

If the system has been activated automatically, an audible sound warning will only be given when obstacles in front are at a distance of less than 50 cm.

ⓘ CAUTION

The automatic connection of the Parking Aid only works when you are driving slowly. If driving style is not adapted to the circumstances, an accident and serious injury or damage may be caused.

Segments of the visual indication

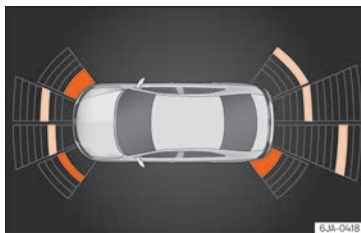

Fig. 229 Parking Aid display on the Easy Connect system screen.

The distance of separation from the obstacle can be estimated using the segments around the vehicle.

The optical indication of the segments works as follows:

White segments: a white segment is displayed when the obstacle is not within the vehicle's trajectory or the direction of travel is in the opposite direction to its location.

Yellow segments: obstacles located in the vehicle's trajectory and which are more than 30 cm away from the vehicle are displayed in yellow.

Red segments: obstacles that are less than 30 cm away from the vehicle are displayed in red.

Moreover, with the SEAT Media System Plus/Navi System radios, a yellow trail indicates the vehicle's expected journey based on the steering wheel angle.

Whenever the obstacle is located in the vehicle's direction of travel, the corresponding audible warning will sound.

As the vehicle approaches an obstacle, the segments are displayed closer to the vehicle. When the penultimate segment is displayed, this means that the vehicle has reached the collision zone. In the collision zone, the obstacles are represented in red, including those out of the path. Do not continue to move forward (or backward) »»  in **General information on page 223**, »» ⓘ in **General information on page 223**!

Adjusting the display and audible warnings

The settings for the display and audible warnings are controlled via the Easy Connect*.

Automatic activation

on – activates the **Automatic activation** option »» page 225.

off – deactivates the **Automatic activation** option »» page 225.

Front volume*

Volume in the front and rear area.

Front sound settings/sharpness*

Frequency (tone) of the sound in the front area.

Rear volume*

Volume in the rear area.

Rear sound settings/sharpness*

Frequency (tone) of the sound in the rear area.





Adjust volume

With the parking aid switched on, the active audio/video source volume will be reduced to the intensity of the selected setting.

Error messages

When the Parking Aid is activated or when it is switched on, if a continuous warning can be heard for several seconds (additionally, in the case of Parking system Plus, the LED of the **P** button flashes), there is a fault in the system.

Parking System Plus*

If there is a fault in a sensor, the symbol  is displayed on the Easy Connect display in front of/behind the vehicle. If a rear sensor is faulty, only the obstacles in the areas  and  are displayed »» Fig. 226. If a front sensor is faulty, only the obstacles in the areas  and  are displayed.

Have the fault corrected by a specialised workshop without delay.

Towing bracket

In vehicles equipped with a towing bracket device from the factory, when the trailer is connected electrically, the Parking Aid rear sensors will not be activated when reverse gear is engaged, when the selector lever is turned to position **R** or when the button **P** is pressed.

Parking System Plus

The distance to possible obstacles at the rear of the vehicle will not be displayed on the screen and nor will it be indicated by means of audible sound signals.

The Easy Connect system screen will only display objects detected at the front, and the vehicle's trajectory will be hidden.

Rear Assist “Rear View Camera”*

Operating and safety warnings

WARNING

- The Rear Assist does not make it possible to precisely calculate the distance from obstacles (people, vehicles, etc.) and nor can it overcome the system's own limits, hence using it may cause serious accidents and injuries if used negligently or without due care. The driver should be aware of his/her surroundings at all times to ensure safe driving.
- The camera lens expands and distorts the field of vision and displays the objects on the screen in a different, vague manner. The perception of distances is also distorted by this effect.

»

- Due to the screen resolution or insufficient light conditions, some items may be displayed in an unsatisfactory manner or not at all. Take special care with thin posts, fences, railings or trees that might not be displayed on screen and could damage the vehicle.
- The rear assist has blind spots where it is not possible to represent people or objects (small children, animals and certain objects cannot be detected in its field of vision). Monitor the vehicle's surrounding area at all times.
- Keep the camera lens clean, free of ice and snow, and do not cover it.
- The system is not a replacement for driver awareness. Supervise the parking operation at all times, as well as the vehicle's surrounding area. Adapt your speed and driving style at all times to suit visibility, weather, road and traffic conditions.
- Do not be distracted from the traffic by looking at the screen.
- The images on the rear assist screen are only two-dimensional. Due to a lack of spatial depth, protruding parts or holes in the road, for example, are more difficult to detect or may not be seen at all.
- Vehicle load modifies the representation of the orientation lines displayed. The width represented by the lines diminishes with vehicle load. Pay special attention to the vehicle's surroundings when the inside

of the vehicle of the luggage compartment is carrying a heavy load.

- In the following situations, the objects or other vehicles shown in the navigation system display appear to be further away or closer than they really are: Pay special attention:
 - On moving from a horizontal plane to a slope.
 - On moving from a slope to a horizontal plane.
 - If the vehicle is heavily loaded at the rear.
 - When the vehicle approaches objects that are not on the ground surface or are jutting out from it. These objects may also be outside the camera's angle of vision when reversing.

i Note

- It is important to take great care and pay special attention if you are not yet familiar with the system.
- Rear assist will not be available if the vehicle's rear lid is open.

Instructions for use

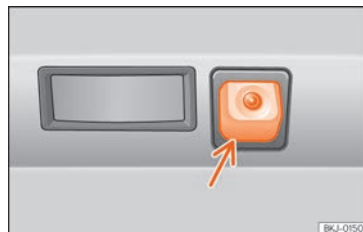

Fig. 230 On the rear bumper: location of the rear assist camera.

A camera on the rear bumper aids the driver during reverse parking or manoeuvring »» **Fig. 230**. The camera image is viewed together with orientation lines projected by the system on the Infotainment system screen. The bottom of the screen displays part of the bumper corresponding to the number plate area that will be used as reference by the driver.

Rear assist settings

Rear assist offers the user the possibility to change the image's *brightness*, *contrast* and *colour* settings.

To change these settings:

- Park the vehicle in a safe place.
- Apply the parking brake.

- Switch the ignition on.
- If necessary, switch on the Infotainment system.
- Engage reverse gear or turn the selector lever to position **R**.
- Press the  function button displayed on the right of the image.
- Make the desired adjustments on the menu by pressing the **-/+** function buttons or by moving the corresponding scroll button.

Necessary conditions for parking and manoeuvring with the rear assist

The system should not be used in the following cases:

- If the image displayed is not very reliable or is distorted, for example low visibility or dirty lens.
- If the area behind the vehicle is not displayed very clearly or is incomplete.
- If the vehicle is heavily loaded at the rear.
- If the position and installation angle of the camera have been changed, e.g. after a rear-end collision. Have the system checked by a specialised workshop.

Familiarising yourself with the system

To familiarise yourself with the system, the orientation lines and their function, SEAT recommends practising parking and manoeu-

vring with the rear assist in a place without too much traffic or in a car park when there are good weather and visibility conditions.

Cleaning the camera lens

Keep the camera lens clean and clear of snow and ice:

- Moisten the lens using a normal alcohol-based glass cleaning product and clean the lens with a dry cloth.
- Remove snow using a small brush.
- Use de-icing spray to remove any ice.

CAUTION

- Never use abrasive cleaning products to clean the camera lens.
- Do not use hot or warm water to remove ice or snow from the camera lens. Doing so could damage the camera.

Parking and manoeuvring with the rear assist

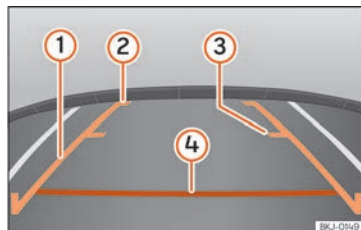

Fig. 231 Display on the Infotainment system screen: guidance lines.

Switching the system on and off

- The rear assist will switch on when the ignition is on or the engine running, on engaging reverse gear (manual gearbox) or on changing the selector lever to the **R** position (automatic gearbox).
- The system switches off 8 seconds after disengaging reverse gear (manual gearbox) or removing the selector lever from the **R** position (automatic gearbox). The system will also disconnect immediately after the ignition is switched off.

In combination with the Parking System Plus **» page 222**, the camera image will cease to be transmitted immediately when reverse gear is engaged or when the selector lever is **»**

moved from the **R** position, and the optical information provided by the Parking Aid system will be displayed.

Also in combination with the system, the rear assist image can also be concealed:

- By pressing one of the Infotainment system buttons on the display.
- OR: By pressing the miniature vehicle that appears on the left of the screen (which switches to the full-screen mode of the Parking System Plus's optical system).

If you wish to display the rear assist image again:

- Disengage reverse, or change the selector lever's position, engage reverse again or move the selector lever to position **R**.
- OR: Press the **RVC** function button¹⁾

Meaning of the orientation lines

»» Fig. 231

- ① **Side lines:** extension of the vehicle (the approximate width of the vehicle plus the rear view mirrors) on the road surface.

- ② **End of the side lines:** the area marked in green ends approximately 2 m behind the vehicle on the road surface.
- ③ **Mid line:** indicates a distance of approximately 1 m behind the vehicle on the road surface.
- ④ **Horizontal red line:** indicates a safe distance of approximately 40 cm at the rear of the vehicle on the road surface.

Parking manoeuvre

- Place the vehicle in front of the parking space and engage reverse gear (manual gearbox) or move the selector to the **R** position (automatic gearbox).
- Reverse slowly, and turn the steering wheel so that the side orientation lines lead towards the parking space.
- Guide the vehicle into the parking space so that the side orientation lines run parallel to it.

Fatigue detection (break recommendation)*

Introduction

The Fatigue detection informs the driver when their driving behaviour shows signs of fatigue.

WARNING

Do not let the comfort afforded by the Fatigue detection system tempt you into taking any risks when driving. Take regular breaks, sufficient in length when making long journeys.

- The driver always assumes the responsibility of driving to their full capacity.
- Never drive if you are tired.
- The system does not detect the tiredness of the driver in all circumstances. Consult the information in the section »» page 231, System limitations.
- In some situations, the system may incorrectly interpret an intended driving manoeuvre as driver tiredness.
- No warning is given in the event of the effect called microsleep!

¹⁾ WARNING: the **RVC** function button will only be activated and available when the reverse gear is engaged or the selector lever is set to position **R**.

- Please observe the indications on the instrument panel and act as is necessary.

Note

- Fatigue detection has been developed for driving on motorways and well paved roads only.
- If there is a fault in the system, have it checked by a specialised workshop.

Function and operation

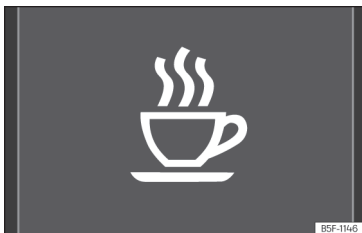

Fig. 232 On the screen of the instrument panel: fatigue detection.

Fatigue detection determines the driving behaviour of the driver when starting a journey, making a calculation of tiredness. This is constantly compared with the current driving behaviour. If the system detects that the driver is tired, an audible warning is given with a

sound and an optic warning is shown with a symbol and complementary message on the instrument panel display »» Fig. 232. The message on the instrument panel display is shown for approximately 5 seconds, and depending on the case, is repeated. The system stores the last message displayed.

The message on the instrument panel display can be switched off by pressing the **OK/RESET** button on the windscreen wiper lever or the button **OK** on the multi function steering wheel »» page 27.

The message can be recalled to the instrument panel display using the multifunction display »» page 27.

Conditions of operation

Driving behaviour is only calculated on speeds above about 65 km/h (40 mph) up to around 200 km/h (125 mph).

Switching on and off

Fatigue detection can be activated or deactivated in the Easy Connect system with the **CAR** button and the **SETTINGS** function button »» page 24. A mark indicates that the adjustment has been activated.

System limitations

The Fatigue detection has certain limitations inherent to the system. The following condi-

tions can limit the Fatigue detection or prevent it from functioning.

- At speeds below 65 km/h (40 mph)
- At speeds above 200 km/h (125 mph)
- When cornering
- On roads in poor condition
- In unfavourable weather conditions
- When a sporty driving style is employed
- In the event of a serious distraction to the driver

Fatigue detection will be restored when the vehicle is stopped for more than 15 minutes, when the ignition is switched off or when the driver has unbuckled their seat belt and opened the door.

In the event of slow driving during a long period of time (below 65 km/h, 40 mph) the system automatically re-establishes the tiredness calculation. When driving at a faster speed the driving behaviour will be recalculated.

Towing bracket device

Driving with a trailer

Technical requirements

If your vehicle has a factory-fitted towing bracket or is equipped with a selection of SEAT Original Accessories, it meets all the relevant technical and legal requirements.

In vehicles with a towing bracket it is possible to remove the ball joint, situated (together with the special assembly instructions) in the housing for the spare wheel in the vehicle luggage compartment »» page 78, **Vehicle tool kit***.

Your vehicle is fitted with a 13-pole power socket for the electrical connection between the trailer and the vehicle. If the trailer you are going to use has a **7-pin connector**, the corresponding adaptor, acquired from the SEAT Original Accessories Catalogue, can be used.

If a towing bracket is to be retro-fitted to the car, it must be done according to the instructions of the towing bracket manufacturer.

Note

Any queries that may arise can be directed to an authorised SEAT dealer.

Trailer weight

Trailer weight

The combined vehicle and trailer must be balanced. To do so use the maximum permitted towing bracket load. An insufficient weight exerted by the trailer drawbar on the ball joint of the towing bracket will have a negative impact upon the response of the vehicle-trailer assembly on the road.

Weight distribution

Distribute loads in the trailer so that heavy objects are as near to the axle as possible. Ensure that the objects do not move.

If the towing vehicle is empty and the trailer loaded then the load distribution is incorrect. However, if these conditions cannot be avoided, drive very slowly.

Tyre pressure values

Correct the tyre pressure in your vehicle to "total load" »» page 256, **Service life of tyres**.

Trailer weight

Never exceed the authorised trailer weight under any circumstances »» page 275, **Technical specifications**.

The trailer weights listed are only applicable for **altitudes** up to 1000 m above sea level.

Due to lower air density, engine power decreases depending on the increase in altitude, this also reduces climbing ability, which requires a reduction of the weight of the vehicle with a trailer by 10% for every 1000 m increase in altitude. The weight of the assembly is calculated by adding the vehicle weight (loaded) to the trailer weight (loaded). Always drive with special care when towing a trailer.

The towed load and support load information that is displayed on the towing bracket manufacturers label are only values for the verification of the device. The correct figures for your specific vehicle, which are usually lower than these figures, are given in the documentation of your vehicle.

WARNING

- Exceeding the maximum established load per axle and the maximum towing bracket load in addition to the maximum permitted load or the load of the vehicle + trailer assembly can cause accidents and serious injuries.
- A sliding load can considerably affect the stability and safety of the vehicle + trailer assembly, resulting in accidents and serious injuries.

Driving with a trailer

Exterior mirrors

Check whether you can see enough of the road behind the trailer with the standard rear vision mirrors. If this is not the case, you should have additional exterior mirrors fitted. Observe the relevant statutory requirements of the country you are in.

Headlights

The front part of the vehicle may be raised when the trailer is connected and the light may dazzle the rest of the traffic.

Adapt the height of the headlights using the headlight range adjuster »» page 121¹⁾.

Driving speed

For your own safety do not drive faster than the maximum permitted speed indicated on the trailer.

At all times, immediately reduce speed if you detect the slightest swaying movement of the trailer. Never try to "return the trailer to a straight position" by accelerating.

Brakes

Brake in due course! If the trailer has an **over-run brake**, apply the brakes gently at first and then, firmly. This will prevent the jerking that can be caused by locking of trailer wheels. Change to a lower gear in good time before descending a slope in order to take advantage of the engine brake.

The trailer is incorporated into the vehicle's anti-theft alarm system:

- When the vehicle has a factory-fitted anti-theft alarm and a towing bracket.
- When the trailer is electrically connected to the vehicle via the towing bracket socket.
- When the vehicle electrical device and the towing bracket are operational.
- When the vehicle is locked and the vehicle's anti-theft alarm device is activated.

Once the electrical connection is interrupted with the vehicle trailer locked, the alarm sounds.

Always switch off the vehicle anti-theft alarm device before connecting or disconnecting a trailer. The vehicle anti-theft alarm device could cause the alarm to sound »» page 116, **Anti-theft alarm***.

Engine overheating

In the event that the coolant temperature gauge needle moves to the right section of the scale or to the red area, immediately reduce speed. If the control lamp  flashes on the general instrument panel, stop the vehicle and switch off the engine. Wait several minutes and check the coolant level in the tank »» page 249.

Please observe the following indications »» page 248.

The coolant temperature can be reduced by switching on the heating.

WARNING

- **Adjust your speed to suit the road and traffic conditions.**
- **An electrical installation that is connected incorrectly or by non-specialised personnel can prevent the connection of the current to the trailer and cause faults in the operation of the electrical system throughout the entire vehicle, leading to accidents and serious injury.**
- **All electrical work must be carried out only by specialised services.**
- **Never directly connect the trailer electrical device to the electrical sockets of the** »

¹⁾ This does not apply for vehicles with Full LED xenon headlights.

reverse driving lights or other sources of electrical current.

ⓘ CAUTION

- Avoid corners, and sudden and sharp braking.
- Once the trailing arm has been removed, place the corresponding cover on the hole of the fastening point. This prevents dirt from entering the hole – see the trailer system assembly manual.

ⓘ Note

- In the event of frequent journeys with a trailer, we recommend also having the vehicle inspected in between the service intervals.
- When connecting and disconnecting the trailer, the handbrake must be applied.
- For technical reasons, trailers with LED reverse lights cannot be incorporated into the vehicle anti-theft alarm system.

Towing bracket device

Introduction

If the vehicle is equipped with a towing bracket device from the factory or is a genuine

SEAT accessory, it meets all national technical and legal requirements for towing.

Your vehicle is fitted with a 13-pin power socket for the electrical connection between the trailer and the vehicle. If the trailer is equipped with a **7-pin connector**, you can use the corresponding adaptor, which is available as a genuine SEAT accessory.

The towing device has a maximum vertical load of **50 kg**.

⚠ WARNING

- Before driving with the ball-headed bar fitted, verify its correct assembly and placement in the clamping bush.
- Do not use the ball-headed bar if it is not correctly placed and fixed in the clamping bush.
- Do not use the towing device for towing if it is damaged or has missing parts.
- Do not modify or adapt the towing device connection.
- Never disengage the ball-headed bar with the trailer still hitched.

ⓘ CAUTION

Be careful not to damage the paint on the bumper when handling the ball-headed bar.

Description

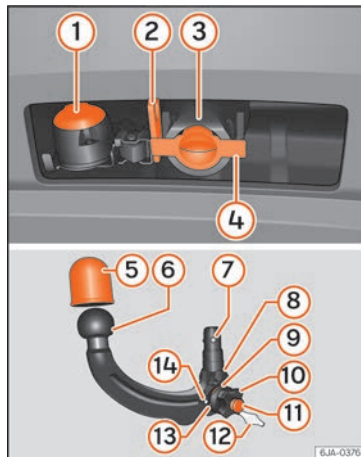

Fig. 233 Towing bracket device support for hitching/ball-headed bar.

The ball-headed bar is detachable. It is located in the spare wheel well or in the spare wheel compartment in the boot » page 78, Vehicle tool kit*.

Key to » **Fig. 233**

- ① 13-pin socket
- ② Safety flange

- ③ Clamping bush
- ④ Clamping bush cap
- ⑤ Ball head cover
- ⑥ Ball-headed bar
- ⑦ Locking balls
- ⑧ Centred
- ⑨ Red marking on the manual regulator
- ⑩ Manual regulator
- ⑪ Key
- ⑫ Key slot cover
- ⑬ Red marking on the manual regulator
- ⑭ White marking on the ball-headed bar

Note

Contact an Authorised Service Partner if you lose your key.

Placing in service position

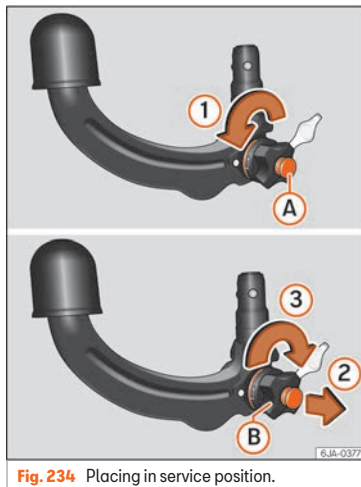

Fig. 234 Placing in service position.

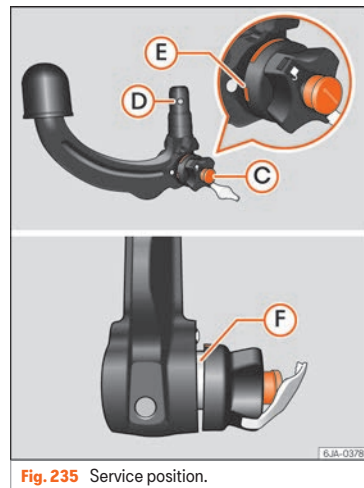

Fig. 235 Service position.

Before assembling, place the ball-headed bar in service position.

- Turn key (A) fully in the direction of arrow (1) » **Fig. 234.**
- Hold the ball-headed bar with your left hand.
- Pull manual regulator (B) outward in the direction of arrow (2) and turn it fully in the direction of arrow (3). »

The manual regulator will remain in this position.

Service position »» Fig. 235

- Key **C** is in an open position – the key arrow points to the “unlocked” symbol. The key cannot be removed from the key slot.
- The **D** locking balls may be fully inserted into the body of the ball-headed bar by applying some pressure.
- The red **E** marking on the manual regulator points towards the white marking on the ball-headed bar.
- Between the manual regulator and the body of the ball-headed bar there is a clearly visible space of approximately 4 mm **F**.

Once the ball-headed bar has been positioned like this, it will be ready to be placed in the clamping bush.

⚠ WARNING

Do not use the ball-headed bar if it cannot be correctly placed in the service position.

ⓘ CAUTION

The key cannot be removed from the manual regulator key slot when it is in the service position.

Assembly of the ball-headed bar

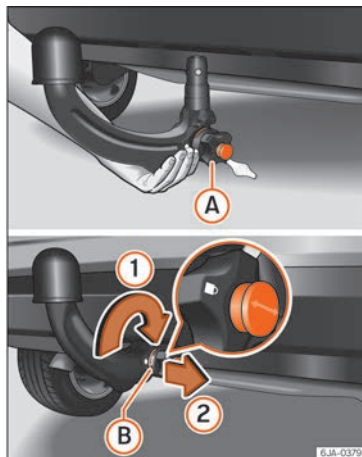

Fig. 236 Placing the ball-headed bar/locking and removing the key.

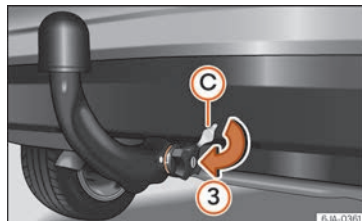

Fig. 237 Placing the key slot cover.

- Remove the cap from the clamping bush **4** »» Fig. 233 by pulling downwards.
- Place the ball-headed bar in the service position »» page 235.
- Hold the ball-headed bar from underneath »» Fig. 236 and push it into the clamping bush as far as possible until you hear it click into place »» ⚠.

The manual regulator **A** automatically turns in the opposite direction, adjusting to the ball-headed bar »» ⚠.

- Switch off the manual regulator lock with key **B** by turning the key fully to the right in the direction of arrow **1** – the arrow in the key displays the “locked” symbol.
- Remove the key in the direction of arrow **2**.
- Place cover **C** over the manual regulator lock in the direction of arrow **3** »» Fig. 237.

- Verify the correct placement of the ball-headed bar »» page 237.

⚠ WARNING

- Do not hold the manual regulator with your hand when fitting the ball-headed bar since you could sustain injuries to your fingers.
- When mounting the ball-headed bar, always lock it with a key and remove the key from the slot.
- The ball-headed bar must not be in the service position with the key in the key slot.
- If the ball-headed bar is not placed in the service position you will not be able to place it in the clamping bush.

ⓘ CAUTION

When removing the key, always place the cover over the key slot of the manual regulator to prevent dirt from entering.

i Note

Once removed, place the clamping bush cap in an appropriate location in the boot.

Verification of correct placement

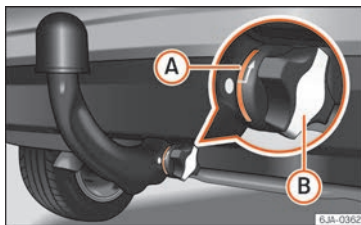

Fig. 238 Correct placement of the ball-headed bar.

Before using the ball-headed bar, ensure it is correctly fitted.

Ensure that:

- The ball-headed bar does not come out of the clamping bush in a “jerky” manner.
- The red mark **A** »» **Fig. 238** on the manual regulator signals toward the white mark on the ball-headed bar.
- The manual regulator is adjusted to the ball-headed bar, leaving no space between them.
- The regulator is locked and the key has been removed.
- Cover **B** has been placed over the manual regulator lock.

⚠ WARNING

Only use the towing bracket device when the ball-headed bar is properly fitted!

Disassembly of the ball-headed bar

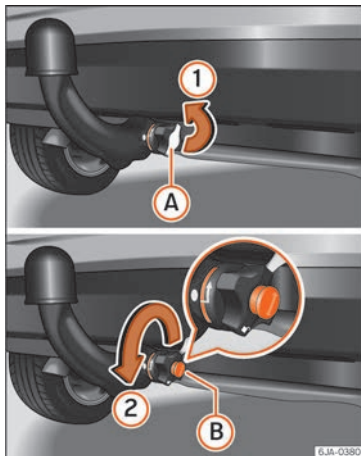

Fig. 239 Remove the key slot cover/unlock with the key.



Fig. 240 Unblock the ball-headed bar.

- Remove cover (A) from over the regulator key slot in the direction of arrow ①
»» Fig. 239.
- Insert key (B) in the key slot.
- Open the manual regulator lock by turning key (B) fully to the left in the direction of arrow ②. The arrow on the key points to the “unlocked” symbol.
- Hold the ball-headed bar from underneath
»» Fig. 240 and remove manual regulator (C) with your other hand in the direction of arrow ③.
- Turn the removed regulator fully in the direction of arrow ④ and hold it firmly in this position.
- Remove the ball-headed bar from the clamping bush, pulling downward in the direction of arrow ⑤.

The ball-headed bar should be placed in the service position so that it is ready to be inserted into the clamping bush »» ①.

- Place the cover over the clamping bush ④
»» Fig. 233.

⚠ WARNING

- Never leave the ball-headed bar unsecured in the boot. It could be damaged in the event of sudden braking, putting the safety of passengers at risk!
- Never disassemble the ball-headed bar with the trailer still hitched.

ⓘ CAUTION

- If you do not turn the manual regulator fully, it will return to its original position when the ball-headed bar is removed. The manual regulator will be stuck to the ball-headed bar and you will not be able to put it in the service position. Therefore, before you assemble it again, you must place the ball-headed bar in this position.
- After disassembly, place the cap on the clamping bush's orifice. This way you will prevent dirt from entering the clamping bush.

ⓘ Note

- Before disassembling the ball-headed bar, we recommend placing the cover on the ball head.

- Clean the ball-headed bar thoroughly before returning it to the on-board toolbox.

Use and maintenance

Cover the clamping bush with the cap to prevent dirt from entering.

Before hooking on the trailer, check the ball head and, if necessary, lubricate it with adequate lubricant.

Place the protective cover over the ball head when storing the bar. This way, you will avoid getting the boot dirty.

If it gets dirty, clean and dry the clamping bush thoroughly with an appropriate product.

CAUTION

The top part of the clamping bush opening is lubricated. Be careful not to remove this lubrication.

Practical tips

Accessories and modifications to the vehicle

Accessories and modifications to the vehicle

Accessories, replacement parts and repair work

If you wish to retrofit accessories in the vehicle, or if a part of the vehicle has been replaced by a new part or technical modifications are required, the following instructions must be taken into account:

- **Before** purchasing accessories or spare parts and **before** making technical modifications, always request advice from an Authorised SEAT dealer »»» ⚠.
- In the event that technical modifications are carried out on the vehicle, the instructions and regulations specified by the company, SEAT, must be observed.

No damage will be caused to the vehicle if the established procedures are respected, which guarantees safe driving and operation. After the modifications are carried out, the vehicle will comply with the restrictions and

regulations of the highway code. More information can be obtained at an Authorised SEAT dealer, where all jobs required can be carried out appropriately.

Vehicle improvements and modifications

The owner must keep the technical documentation regarding the modifications carried out on the vehicle so it can be handed over to those responsible for processing end-of-life vehicles. This ensures end-of-life processing of the vehicle, while protecting the environment.

Work done on the electrical components and software can cause disruption in operations. Due to the interconnection of electronic components, their malfunction can also impair systems that are not directly affected. This can adversely affect reliability of the vehicle, and can produce excessive wear of the parts.

Damage caused by technical modifications that are not made with the consent of SEAT will be excluded from the warranty – see warranty certificate.

⚠ WARNING

- **Jobs or modifications unduly carried out on your vehicle can cause disruption to operations - Risk of accident!**
- **We recommend that you use only expressly authorised SEAT Accessories and SEAT Original Spare Parts for your vehicle.**

The reliability, safety and compatibility with your vehicle of SEAT original spare parts and accessories has been verified.

- **Despite the continuous observation of the market, we cannot judge nor guarantee the suitability of other products for your vehicle, be they authorised products or products approved by a state testing facility.**

Note

SEAT original spare parts and accessories can be purchased at authorised SEAT dealers where the purchased parts can also be fitted.

Modifications and effects of the airbag system

In the adjustment and modification, respect the SEAT directive.

Modifications and corrections of the front bumper, doors, front seats, roof or bodywork must be carried out at authorised SEAT workshops. Components of the airbag system can be found in these parts of the vehicle.

⚠ WARNING

- **Airbag modules must never be repaired. They must be replaced.**
- **Never fit components of the airbag system removed from old vehicles or those**

originating from a recycling process in the vehicle.

- The modification of the suspension of the vehicle wheels, including the use of non-permitted combinations of tyres and rims can alter the operation of the airbag system and increase the risk of serious or fatal injuries in an accident.
- During all jobs on the airbag system, in addition to the removal and fitting of parts of the system in the course of other repair jobs, parts of the airbag system can be damaged. Therefore in the event of an accident, this may cause the airbags to activate incorrectly or not activate at all.

Radio and aerial reception

In vehicles factory-fitted with an audio or navigation system, the aerial may be installed in different places:

- inside the rear window next to the heating elements,
- on the roof of the vehicle.

Checking and refilling levels

Fuel

Refuelling

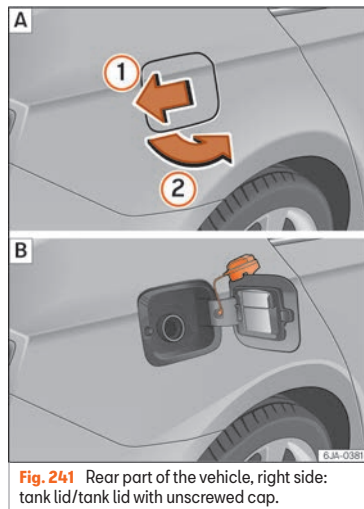



Fig. 241 Rear part of the vehicle, right side: tank lid/tank lid with unscrewed cap.

Read the additional information carefully
 »»  page 41

The correct type of fuel for your vehicle is indicated on a sticker on the inside of the fuel tank flap, along with the tyre size and pressure »» **Fig. 241 B**.

Vehicles with a fuel cap with key

- Press the flap in the direction of the arrow ① »» **Fig. 241**.
- Open the cover in the direction indicated by the arrow ②.
- Hold onto the fuel tank cap with one hand and unlock it using the ignition key, turning it anti-clockwise.
- Unscrew the tank cap anti-clockwise and place it on top of the tank flap »» **Fig. 241 B**.
- Insert the pump nozzle into the fuel feed tube as far as it will go.

The fuel tank is full as soon as the automatic filler nozzle cuts out »» ❶.

- Remove the pump nozzle from the fuel feed tube and place it back on the pump.
- Screw the tank cap clockwise until it clicks into place.
- Hold onto the fuel tank cap with one hand and lock it using the ignition key, turning it clockwise.
- Press the tank flap with your hand to close it.

»

- Check that the fuel flap is correctly closed.

Vehicles with a keyless fuel cap (the side flap will unlock using the central locking system)

- Once the vehicle has been unlocked using the central locking button, press the fuel flap in the direction of the arrow ①
»» Fig. 241.
- Open the cover in the direction indicated by the arrow ②.
- Unscrew the tank cap anti-clockwise and place it on top of the tank flap »» Fig. 241 [B].
- Insert the pump nozzle into the fuel feed tube as far as it will go.

The fuel tank is full as soon as the automatic filler nozzle cuts out »» ①.

- Remove the pump nozzle from the fuel feed tube and place it back on the pump.
- Screw the tank cap clockwise until it clicks into place.
- Close the tank flap. Make sure you hear it click into place.
- Check that the fuel flap is properly closed.

⚠ WARNING

Observe all relevant statutory regulations on transporting spare fuel canisters. For safety reasons, we do not recommend carrying a spare canister in the vehicle. The canister could be damaged in an accident and fuel may leak. Risk of fire!

① CAUTION

- Switch off the auxiliary heater (heater and independent heater) before filling the tank.
- The fuel tank is full as soon as the automatic filler nozzle cuts out. Do not continue filling, as this will fill the expansion chamber.
- Never completely empty the tank! An irregular fuel supply can cause ignition faults, which can result in damage to a substantial amount of engine parts and the exhaust system.
- If any fuel is spilt onto the paintwork of the vehicle, it should be removed immediately. Risk of damage to paintwork!

i Note

There is no emergency mechanism for the manual release of the fuel tank flap. If necessary, request assistance from specialised personnel.

i Note

The fuel tank capacity is around 55 litres, of which 7 litres are the reserve.

Identification of the fuel¹⁾

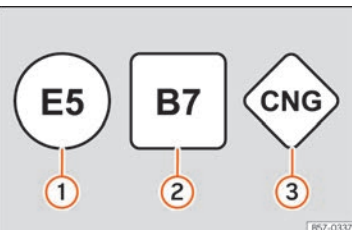

Fig. 242 Identification of fuels according to European Union (EU) Directive 2014/94/

Fuels are identified with different symbols. Depending on the fuel, the different symbols are on the pump and the tank lid of your vehicle. The identification serves to prevent confusion when choosing the fuel.

- ① **Petrol** with ethanol ("E" stands for Ethanol). The number indicates the percentage of ethanol in the petrol. "E5" means, for example, an ethanol ratio of 5% max.

¹⁾ Depending on country

- ② **Diesel** with biodiesel ("B" stands for Biodiesel). The number indicates the percentage of biodiesel in the diesel. "B7" means, for example, a proportion of biodiesel of max. 7%.
- ③ **Natural gas:** "CNG" means **C**ompressed **N**atural **G**as.

Type of petrol

✓ Applies to vehicles: with petrol engine

The correct grade of petrol is listed inside the fuel tank flap.

The vehicle is equipped with a catalytic converter and must only be run on **unleaded petrol**. The petrol must comply with the standard EN 228 and be **sulphur-free**. Fuels with a 10% ethanol ratio can be refuelled (E10)¹⁾. The types of petrol are differentiated by using the **octane numbers (RON)** or via the **anti-knock index (AKI)**.

The following pieces of text show the information included in the corresponding stickers on the tank lid (examples):

Super unleaded petrol 95 octane petrol or normal 91 octane petrol at least

We recommend refuelling with super 95 octane petrol (91 AKI). If not available: normal 91 octane petrol (87 AKI) (with a slight power loss).

Super unleaded petrol, 95 octanes at least

You should use super 95 octane petrol (91 AKI) at least.

If super is not available, *if necessary*, use normal 91 octane petrol (87 AKI). In this case only use moderate engine speeds and a light throttle. Refuel with super as soon as possible.

Unleaded super plus 98 octane petrol or super 95 octane petrol at least

We recommend refuelling with super plus 98 octane petrol (93 AKI). If not available: super 95 octane petrol (91 AKI) (with a slight power loss).

If super is not available, *if necessary*, use normal 91 octane petrol (87 AKI). In this case only use moderate engine speeds and a light throttle. Refuel with super as soon as possible.

ⓘ CAUTION

- Fuels high percentage of ethanol, e.g. E30 - E100 button must not be used. The fuel system would be damaged. Exception: vehicles with Totalflex engine »» page 244, Ethanol fuel.
- A single refuelling with leaded fuel or other metal additives entails a permanent deterioration of the effectiveness of the catalytic converter.
- Only use fuel additives that have been approved by SEAT. The products that contain substances to increase the octane rating or decrease knocking may contain metal additives that damage the engine and catalytic converter. This type of products must not be used.
- Do not use fuels shown in the pump as containing metals. LRP (*lead replacement petrol*) fuels contain high concentrations of metal additives. Risk of engine damage!
- High engine speed and full throttle can damage the engine when using petrol with an octane rating lower than the correct grade for the engine.

ⓘ Note

- Fuel with an octane rating higher than the one required by the engine can be used. »

¹⁾ Follow the regulations of the country you are driving in.

- In countries in which there is no sulphur-free fuel, it is also allowed to use low sulphur content fuel.

Ethanol fuel

- ✓ Applies to vehicles: with Totalflex engine

You can recognise vehicles with Totalflex engines¹⁾ by label on the fuel tank lid with with the marking "Petrol/ethanol".

Vehicles with Totalflex engine can run with unleaded petrol (95 octane / 91 AKI) according to ANP No. 57 and with fuels with any high percentage of ethanol. The vehicle is refuelled in the same way as petrol refuelling.

Also consider that »» page 243, Type of petrol

Note

SEAT recommends filling the tank exclusively with petrol every 10,000 km to decrease impurities that using E100 ethanol fuel might have left in the engine.

Diesel

- ✓ Applies to vehicles: with diesel engine

Please note the information on the inside of the fuel tank flap.

We recommend you use **Diesel** according to standard EN 590.

The diesel can thicken at very low temperatures, thus affecting the start or operation of the engine. To ensure that you can continue to use your vehicle as usual, the diesel sold in gas stations is provided -depending on the station- with fluidity when cold. Ask the employee of the petrol station whether their diesel is suitable for use in winter and if it is suited for current and future temperatures.

Water in the fuel filter²⁾

If your vehicle has a diesel engine and is equipped with a **fuel filter with a water separator**, the instrument panel may display the following warning:  **Water in the fuel filter**. If this is the case, take the vehicle to a specialised workshop so that they can drain the fuel filter.

CAUTION

- Never use of FAME (biodiesel), petrol, heating oil, other fuels or thinning agents as they can cause severely damage the fuel system and the engine.
- If the wrong fuel has been filled, do not start the engine under any circumstances. Risk of damaging the fuel system and the engine! Obtain technical assistance.

Engine compartment

Working in the engine compartment

Read the additional information carefully »»  page 13

Always be aware of the danger of injury and scalding as well as the risk of accident or fire when working in the engine compartment, e.g. when checking and refilling fluids. Therefore, always observe the warnings and follow all general safety precautions. The engine compartment is a dangerous area.

¹⁾ This motor is only available in some markets.

²⁾ Valid for the market: Algeria.

WARNING

- Never open the bonnet if you see steam, smoke or coolant escaping from the engine compartment. Risk of scalding! Wait until no steam or coolant can be seen before opening the bonnet.
- Switch off the engine and remove the key from the ignition.
- Engage neutral in vehicles with manual gearbox and move the selector lever to position P in vehicles with automatic gearbox.
- Apply the handbrake firmly.
- Wait for the engine to cool down.
- For safety reasons, the bonnet must always be closed when the vehicle is moving. Therefore, after closing the bonnet always check that it is properly secured.
- Should you notice that the bonnet is not safely secured when the vehicle is moving, stop the vehicle immediately and close the bonnet properly. Risk of accident!
- Keep children away from the engine compartment.
- Do not touch hot engine parts. Risk of burns!
- Never spill fluids on hot engine compartments. These fluids can cause a fire (e.g. antifreeze in coolant)!
- Take care not to cause short circuits in the electrical system, especially when working on the battery.

- Never touch the radiator fan when the engine is hot. The fan may start running suddenly!
- Never cover the engine with additional insulating materials such as a blanket. Risk of fire!
- Do not unscrew the cap on the coolant expansion tank when the engine is hot. The cooling system is under pressure!
- Protect face, hands and arms from any hot steam or hot coolant released by covering the cap with a large, thick rag when opening the expansion tank.
- Do not leave any objects, such as cloths or tools, in the engine compartment.
- When working underneath the vehicle, secure it so that it cannot roll away and support it safely on suitable supports. The hydraulic jack is not sufficient for this purpose. Risk of injuries!
- If any tests have to be performed with the engine running, there is an extra safety risk from rotating parts, such as the drive belt, alternator and radiator fan, etc., and from the high-voltage ignition system. You should also note the following:
 - Never touch the electrical wiring of the ignition system.
 - Keep away from moving engine parts when wearing jewellery, loose clothing or long hair. Risk of fatal injuries! All jewellery must be removed, hair tied back and close-fitting clothing worn.

- Observe the following additional warnings if work on the fuel system or the electrical system is necessary.
 - Always disconnect the battery from the on-board network.
 - Do not smoke.
 - Never work near naked flames.
 - Always keep an approved fire extinguisher immediately available.

CAUTION

- When topping up fluids, make sure the correct fluid is put into the correct filler opening. Otherwise this can cause serious malfunctions or engine damage!
- Never open the bonnet using the release catch. Risk of damage!

For the sake of the environment

Due to the environmentally-friendly disposal of fluids, the equipment necessary and the knowledge required, let an authorised SEAT dealer change fluids during service inspections of the vehicle.

Note

- Please contact an authorised SEAT dealer with any doubts regarding fluids.
- Fluids of the correct specifications can be acquired from the selection of SEAT Original Accessories.

Checking levels

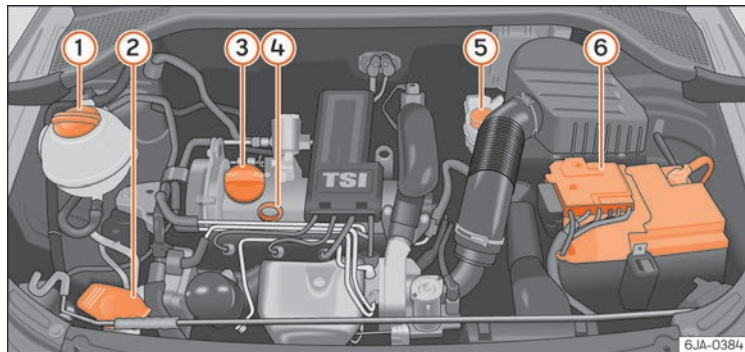

Fig. 243 Diagram for the location of the various elements.

From time to time, the levels of the different fluids in the vehicle must be checked. Never fill with incorrect fluids, otherwise serious damage to the engine may be caused.

- | | | |
|---|---------------------------------|-----|
| ① | Coolant expansion tank | 249 |
| ② | Window washer water tank | 251 |
| ③ | Engine oil filler cap | 248 |
| ④ | Engine oil level dipstick | 248 |
| ⑤ | Brake fluid reservoir | 250 |
| ⑥ | Battery | 251 |

The checking and replenishment of the service fluids are carried out on the components

mentioned above. These operations are described in the »» page 244.

Overview

You will find further explanations, instructions and restrictions on the technical specifications as of »» page 275.

i Note

The layout of the engine compartment is very similar to all petrol and diesel engines.

Radiator fan

The radiator is driven by an electric motor and controlled according to the temperature of the coolant.

After the engine has been stopped and the ignition switched off, the radiator fan may continue running for around 10 minutes.

Engine oil

General notes

The engine comes with a special, multi-grade oil that can be used all year round.

Because the use of high-quality oil is essential for the correct operation of the engine and its long useful life, when topping up or changing oil, use only those oils that comply with VW standards.

We recommend that the oil change indicated in the Maintenance Programme, be performed by a technical service or specialised workshop.

If the engine oil level is too low

You can get information about the correct engine oil for your vehicle at your specialised shop. If you have to change your engine oil, use that oil.

If the recommended engine oil is not available, in the event of an emergency you can add oil once up to a maximum of 0.5 L of the next oil until the next oil change:

- *Valid for vehicles with petrol engines:*
standard VW 504 00, VW 502 00,
VW 508 00, ACEA C or API SN.

Vehicles with diesel particulate filter*

Only VW 507 00 engine oil, with reduced ash formation, may be used in diesel engines equipped with particulate filter. Using other types of oil will cause a higher soot concentration and reduce the life of the DPF. Therefore:

- Avoid mixing this oil with other engine oils.
- Only in exceptional circumstances, if the engine oil level is too low »» page 248 and you cannot obtain the oil specified for your vehicle, you can use a small quantity of oil (once) conforming to the specifications VW 506 00, VW 506 01, VW 505 00, VW 505 01 or ACEA B3/ACEA B4 (up to 0.5 l) »»  page 42.

Note

Before a long trip, we recommend finding an engine oil that conforms to the corresponding VW specifications and recommend keeping it in the vehicle. This way, the correct engine oil will always be available for a top-up if needed.

Warning lamp

Flashes red

The information display shows:
Oil pressure. Switch off the engine! Instruction Manual!

 **Do not carry on driving!** Switch off the engine and check the engine oil level »» page 248

If the symbol flashes although the oil level is correct,  **do not drive on.** Do not even run the engine at idle speed! Go to a technical service.

It lights up yellow

The information display shows:
Check oil level!
Park the vehicle, stop the engine and check the engine oil level »» page 248.

If the bonnet stays open for over 30 seconds, the warning lamp switches off. If the engine oil is not refilled, the warning lamp illuminates again after 100 km (62 miles).

It flashes yellow

The information display shows:
Oil sensor! Workshop
If the engine oil level sensor is faulty, The warning lamp  flashes various times after the ignition is switched on and an audible warning is given. Go to a technical service.

Checking engine oil level

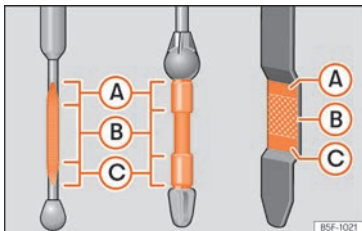

Fig. 244 Engine oil dipsticks.

Read the additional information carefully

» page 42

The dipstick shows the engine oil level.

» Fig. 244.

Checking oil level

- Park the vehicle on a level surface and ensure the engine is at operating temperature.
- Switch the ignition off.
- Open the bonnet.
- Wait a few minutes for the engine oil to flow back to the sump and remove the dipstick.
- Wipe the dipstick with a clean cloth and insert it again as far as it will go.
- Then pull the dipstick out again and check the oil level.

It is normal for the engine to consume a certain amount of oil. Depending on how you drive and the conditions in which the vehicle is used, oil consumption can be up to 0.5 litres per 1,000 km. Oil consumption can also be higher for the first 5,000 km (3000 miles).

You should therefore check the oil level at regular intervals, ideally every time you fill the tank or before setting off on a long trip.

⚠ CAUTION

- The oil level must never exceed area **A**. Risk of damaging the exhaust system!
- If the engine oil cannot be topped up under the given conditions, do not drive on! Stop the engine and seek the professional assistance of an Official Service, as this could cause serious damage to the engine.

Topping up engine oil

- Check the engine oil level » page 248, Checking engine oil level.
- Unscrew the cap from the filler opening.
- Put in the specified grade of oil 0.5 litres at a time » page 247.
- Check the oil level » page 248.
- Replace the oil filler cap carefully and push the dipstick all the way in.

Changing engine oil

Engine oil must be changed with the frequency indicated in the Maintenance Programme or according to the service interval indicator » page 33.

⚠ CAUTION

Do not mix engine oil with additives. Risk of damage to the engine! Damage caused by these products is not covered by the warranty.

Note

Wash your skin thoroughly if it comes into contact with engine oil.

Coolant

Control lamp



It lights up blue

The engine has not yet reached service temperature^{a)}. Avoid high engine speeds, hard acceleration and subjecting the engine to high loads.

^{a)} This does not apply to vehicles equipped with an informative display.



It lights up or flashes red

The coolant temperature is too high or the coolant level too low.

Do not carry on driving! Switch off the engine and check the coolant level » page 249, and fill it if necessary » page 249.

The information display shows:

Check coolant! Instruction Manual!

If the coolant is situated in the prescribed area, the high temperature may be due to a fault in the cooling system fan. Check the radiator fan fuse and replace it if necessary » page 45.

If the warning lamp (red) remains lit up, despite both the coolant level and the radiator fan fuse being in correct condition, **stop the vehicle!**

Go to a technical service.

WARNING

- **Take care when opening the coolant reservoir. When the engine is warm or hot, the system is pressurised – Danger of burns! Wait for the engine to cool before opening the cover.**
- **Do not touch the fan. The fan can switch on automatically regardless of whether the ignition is switched on.**

Checking coolant level

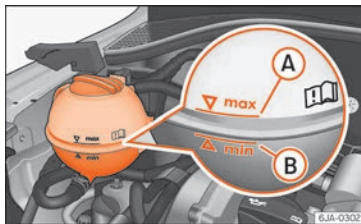

Fig. 245 Engine compartment: coolant tank.

Read the additional information carefully » page 43

The coolant expansion tank is located in the engine compartment of the vehicle.

- Switch the ignition off.
- Open the bonnet » page 244.
- Read off the coolant level on coolant expansion tank » **Fig. 245**. When the engine is cold, the coolant should be between marks **B** (min.) and **A** (max.). When the engine is hot, it may be slightly above mark **A** (max.).

If the coolant fluid level in the reservoir is too low, this will be indicated by the red warning lamp illuminating on the general dash panel » page 248. However, we recommend checking the coolant level directly in the tank.

Coolant fluid loss

Any loss of coolant normally indicates a **leak**. It is not sufficient merely to top up the coolant. The cooling system should be inspected by an Official Service without delay.

CAUTION

- **In the event of a fault that causes the engine to overheat, contact an authorised SEAT dealer immediately, as this could damage the engine.**
- **Anti-freeze that does not correspond to the correct specification may particularly affect corrosion protection considerably.**
- **Faults caused by corrosion may lead to coolant leaks. Risk of serious engine faults!**

Topping up the coolant level

- Switch the ignition off.
- Wait for the engine to cool down.
- Cover the cap on the coolant expansion tank » **Fig. 245** with a cloth and **carefully** unscrew the cap.
- Refill the level of coolant.
- Screw the cap on again until it clicks into place.

Do not use a different type of additive if the prescribed anti-freeze additive is not



available, in the event of an emergency. In this case, use only water and bring the coolant concentration back up to the correct level as soon as possible at an Official Service.

Always top up with unused coolant.

Never fill the coolant tank above mark **A** (max.) **>>> Fig. 245** ! Excess coolant is forced out of the cooling system through the over-pressure valve in the filler cap of the expansion tank when the engine heats up.

⚠ WARNING

- The anti-freeze additive and, therefore, the entire coolant, are a health hazard. Avoid touching the coolant. Coolant fumes are also a health hazard. For this reason, always store the coolant additive in a safe place out of the reach of children. Risk of poisoning!
- If splashed into eyes, rinse immediately with clean water and seek immediate medical attention.
- Seek immediate medical attention if the coolant is accidentally ingested.

ⓘ CAUTION

If the coolant cannot be topped up under the given conditions, **do not drive on**. We recommend contacting an authorised SEAT dealer, as this can damage the engine.

Brake fluid

Checking brake fluid level

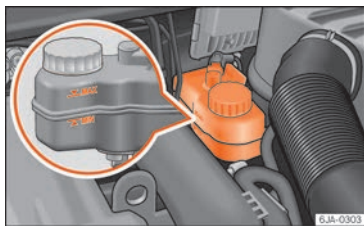

Fig. 246 Engine compartment: coolant tank.

Read the additional information carefully
>>> 📖 page 43

The brake fluid reservoir is located in the engine compartment of the vehicle.

- Switch the ignition off.
- Open the bonnet **>>> page 244**.
- Check the brake fluid level in the reservoir **>>> Fig. 246**. It should be between the “MIN” and “MAX” marks.

The fluid level drops slightly after a period of time due to automatic compensation for brake pad wear. This is quite normal.

However, if the level goes down noticeably in a short time, or drops below the “MIN” mark, there may be a leak in the brake system. If the

brake fluid level in the reservoir is too low, this will be indicated by the warning lamp illuminating on the instrument panel **⚠**
>>> page 200, Control lamps.

⚠ WARNING

- If the fluid level has dropped below the MIN mark, **do not continue driving. Risk of accident! Go to a technical service.**
- Heavy use of the brakes may cause a vapour lock if the brake fluid is left in the brake system for too long. This would seriously affect the efficiency of the brakes and the safety of the vehicle.

Changing the brake fluid

Brake fluid absorbs moisture. Therefore, it gradually absorbs moisture from the atmosphere. If the water content in the brake fluid is too high, the brake system could corrode. The water content also reduces the boiling point of the brake fluid.

The brake fluid must comply with one of the following standards or specifications:

- VW 50114
- FMVSS 116 DOT4

ⓘ CAUTION

Brake fluid damages the vehicle paintwork.

Window washer system

Topping up windscreen washer fluid

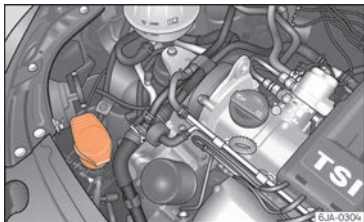

Fig. 247 Engine compartment: windscreen cleaning fluid tank.

Read the additional information carefully

» page 44

The container for the windscreen washer contains the cleaning fluid for the windscreen or rear window and the headlight washer system. The container is located in the engine compartment.

The **capacity** of the reservoir is approximately 3.5 litres; in vehicles with a headlight washer system, it is approximately 5.4 litres¹⁾.

¹⁾ Valid only for certain countries. 5.4 litres for both versions.

Plain water on its own is not enough to clean the glass and the headlights properly. We therefore recommend using clean water with a glass cleaning product to eliminate any stubborn dirt (**with an anti-freeze additive in winter**).

Although your vehicle has heated windscreen washer jets, anti-freeze should always be added to the water in winter.

Ethanol can be used where glass cleaner with anti-freeze is unavailable. The concentration of ethanol must be no greater than 15 %. However, remember that anti-freeze in this proportion only protects down to -5°C (+23°F).

CAUTION

- **Never mix the windscreen washing water with anti-freeze used for the cooling system or other additives.**
- **If the vehicle is equipped with a headlight washer system, only mix in with the water a detergent that does not damage polycarbonates.**

Note

When topping up the fluid, do not move the filter from the container opening, as this

could contaminate the fluid hoses and lead to a windscreen washer malfunction.

Battery

Introduction

Read the additional information carefully
» page 44.

Warning symbols on the battery

	Always wear safety glasses!
	Battery acid is extremely corrosive. Always wear gloves and hearing protection!
	Keep open flames, sparks, uncovered lights and lit cigarettes away when working on the battery!
	A highly explosive mixture of gases is released when the battery is under charge!
	Keep children away from the battery!

Incorrect handling of the vehicle battery could lead to damage. We therefore recommend all work on the vehicle battery be performed by an authorised SEAT dealer. »

Always be aware of the danger of injury and scalding as well as the risk of accident or fire when working on the battery and the electrical system. Therefore, always observe the warnings and follow all general safety precautions.

WARNING

- **Battery acid is very corrosive, therefore, the battery must be handled with the utmost care.** Wear protective gloves and protect your eyes and skin when handling batteries. The corrosive fumes in the air irritate and inflame the respiratory tract and cause conjunctivitis. It corrodes tooth enamel. Causes deep and difficult-to-heal wounds when it comes in contact with the skin. Repeated contact with diluted acids causes skin disease (inflammation, ulcers and fissures). When in contact with water, acids dilute and develop a great deal of heat.
- Do not tilt the battery, as acid could leak out of the vapour vents. Protect your eyes with glasses or a protective helmet! Risk of blindness! If acid should splash into the eyes, rinse the affected eye immediately for several minutes using clean water. Then seek medical care immediately.
- Neutralize any acid splashes on the skin or clothing with soap solution as quickly as possible and rinse off with plenty of water. If acid is swallowed by mistake, consult a doctor immediately.
- Keep children away from the battery.

- Hydrogen is released and a highly explosive mixture of gases is generated when the battery is under charge. Sparks when disconnecting or releasing cable terminals with the ignition switched on could also cause an explosion.
- A short circuit is produced if the battery terminals are bridged, e.g. using metal objects, cables, etc. Possible consequences in the event of a short-circuit: melting of lead plates, battery explosion and fire, splashing acid.
- The following is forbidden during work: fire and open flames, smoking and activities that could produce sparks. Avoid causing sparks when handling cables or electrical apparatus. Risk of injury in the event of large sparks.
- Before working on the electrical system, you must switch off the engine, the ignition and all electrical components and disconnect the cable from the negative terminal (-) of the battery. To change a bulb, simply switch off the corresponding light.
- Never charge a frozen or thawed out battery. Risk of explosion and acid burns! Replace a frozen battery.
- Never use the jump leads on batteries in which the electrolyte level is too low. Risk of explosion and acid burns!
- Never use a damaged battery. Risk of explosion! Replace a damaged battery immediately.

CAUTION

- Never disconnect the battery when the ignition is switched on, as the electrical system (electronic components) of the vehicle could be damaged. When disconnecting the battery from the vehicle electrical system, disconnect its negative terminal (-) first. Only then may the positive terminal (+) be disconnected.
- When connecting the battery, first connect the positive terminal (+) and then the negative terminal (-). The battery cables must never be connected to the wrong battery terminals. Risk of burning the electrical installation!
- Make sure the battery acid does not come into contact with the bodywork. Risk of paintwork damage.
- Do not expose the battery to direct sunlight to protect it from ultraviolet radiation.
- If the vehicle is not used for 3 or 4 weeks, the battery could run flat. This is because some components use electricity even in standby mode [e.g. control units]. Prevent the battery from running flat by disconnecting its negative terminal or leave it charging at a low current.
- If you frequently use the vehicle for short trips, the battery may not fully charge and could run flat.

For the sake of the environment

A flat battery is particularly harmful waste for the environment. It must therefore be disposed of according to current local law.

Note

Replace a battery once it is older than 5 years.

Warning lamp

It lights up



Alternator fault.

The control lamp lights up when the ignition is switched on. It should go out when the engine has started running.

If the control lamp  lights up while driving, the alternator is no longer charging the battery. You should immediately drive to the nearest specialised workshop.

You should avoid using electrical equipment that is not absolutely necessary because this will drain the battery.

CAUTION

Additionally, if the warning lamp  lights up while driving, the warning lamp  also lights up (cooling system fault). Stop the

vehicle and switch off the engine – Risk of engine damage!

Lifting the battery cover



Fig. 248 Battery: opening the cover.

The battery is located beneath a plastic cover in the engine compartment.

- Open the battery cover in the direction indicated by the arrow **»» Fig. 248.**
- The positive terminal (+) of the battery is connected in reverse order.

Checking the battery electrolyte level

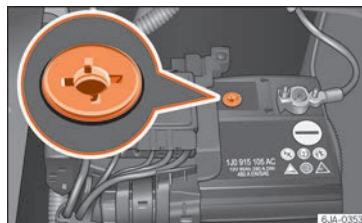

Fig. 249 Battery: electrolyte level indicator.

We recommend you have the acid level regularly checked at an official technical service, particularly in the following cases.

- At high outside temperatures.
- On long daily trips.
- Whenever the vehicle is loaded **»» page 254, Charging the battery.**

In vehicles equipped with a battery with colour indicator, the so-called magic eye **»» Fig. 249** changes colour to indicate the acid level.

Air bubbles can influence the colour of the indicator. Therefore, carefully knock the indicator before checking the acid level.

- Black – the acid level is correct. **»»**

- Colourless or light yellow – acid level too low, battery must be changed.

Note

- The battery acid level is also regularly checked during servicing at authorised SEAT dealers.
- The electrolyte level on “AGM” batteries cannot be checked for technical reasons.
- Vehicles equipped with the “Start-Stop” system include a battery control unit to control the battery level for repeated engine starting.

Winter service

At low temperatures the battery provides only a fraction of the starting power it has at normal temperatures.

A flat battery can also freeze at temperatures slightly below 0°C (+32°F).

We therefore recommend you have the battery checked and, if necessary, charged at an official SEAT technical service before the start of winter.

Charging the battery

A fully-charged battery is essential for reliable starting.

- Switch off the ignition and all electrical equipment.
- Only in the case of “fast charge”: disconnect both battery connection cables (first the “negative” terminal and then the “positive”).
- Connect the charger cables to the battery terminals (red = “positive”, black = “negative”).
- Plug in the battery charger and switch on.
- At the end of the charging process: turn off and unplug the charger.
- Remove the charger cables.
- If necessary, reconnect both battery cables to the battery (first the “positive” cable, then the “negative” cable).

When charging with a low current (e.g. with a **small battery charger**), the battery does not normally have to be disconnected. **The instructions of the battery charger manufacturer must be followed.**

Use a current equivalent to or lower than 10% of the battery capacity to fully charge the battery.

Before “**fast-charging**” the battery however, both battery cables must be disconnected.

“Fast-charging” a battery is **dangerous** and requires a battery charger and special knowl-

edge. Fast charges should be performed by an official technical service.

The battery caps should not be opened while the battery is being charged.

CAUTION

In vehicles fitted with the “Start-Stop” system, the charger cable cannot be directly connected to the negative terminal of the vehicle battery but must be attached to the engine ground point »»  page 54.

Disconnecting and connecting the battery

The following functions will either be inoperative or will not work properly after disconnecting and reconnecting the battery:

Function	Installation
Setting the clock	»» page 99
The multifunction display data is deleted	»» page 101

Note

We recommend having the vehicle checked by an authorised SEAT dealer to guarantee the correct working order of all electrical systems.

Changing the battery

A replacement battery must have the same capacity, voltage, current rating and size as the original. The appropriate types of battery can be acquired from authorised SEAT dealers.

We recommend having the battery changed by an authorised SEAT dealer, where the new battery will be correctly installed and the original disposed of in line with regulations.

Automatic disconnection of electrical equipment

When heavily-charging a battery, the programme selected by the electrical system control unit prevents the battery from automatically discharging. This may result in the following:

- Increase in idling speed so that the alternator can supply more current to the electrical system.
- The performance of certain electrical components could be limited or some may switch off temporarily, e.g. the heated seats, the heated rear window, the 12 V power socket.

Note

Despite any measures taken by the control unit, the battery could drain. e.g. with the

engine is switched off, the key is turned in the ignition for a long period or the side lights or parking lights are switched on. The switching off of certain electrical components does not impair driving comfort and often the driver will not even notice.

Wheels and tyres

Tyres

Introduction

WARNING

- During the first 500 km, new tyres do not give maximum grip, therefore you should drive carefully. Risk of accident!
- Never drive with damaged tyres. Risk of accident!
- Only use wheels and tyres that been authorised by SEAT or your vehicle model. Failure to do so could impair road safety. Risk of accident!
- Never exceed the maximum speed permitted for your tyres. Risk of accident due to tyre damage and loss of vehicle control!
- Under-inflated tyres are submitted to greater rolling resistance. This means that they can overheat at high speeds. This can cause tread separation and even tyre blow-out.
- For driving safety, tyres should be replaced at least in pairs according to the axle and not individually. The tyres with the deepest tread should always be used on the front wheels.
- Never fit used tyres of an unknown age or prior use.



Tread wear indicator

The base of the side of the original tyres on your vehicle show 1.6 mm high tread wear indicators »» Fig. 250. The position of these indicators is given on the tyre sidewalls by the letters "TWI", triangular symbols or other symbols.

The useful life of the tyres depends primarily on the following factors:

Tyre pressure values

Under-inflation or over-inflation will considerably reduce the useful life of the tyres and impair the vehicle's handling. Therefore, check the tyre pressure, including the spare wheel, at least once a month and before any long journey.

Inflation pressures for **summer tyres** are listed on a sticker inside the fuel tank flap »» Fig. 251. The pressures for **winter tyres** are 0.2 bar (2.9 psi/20 kPa) above the summer values.

Always check the pressure when the tyre is cold. Do not reduce over-pressure in warm tyres. The tyre pressures must be altered to suit notable changes in the load being carried.

Depending on the vehicle, tyre pressure can be adjusted to medium load to improve driving comfort ("comfort" tyre pressure). When

driving with comfort tyre pressure fuel consumption may increase slightly.

Driving style

Fast cornering, heavy acceleration and hard braking all increase tyre wear.

Wheel balancing

The wheels on new vehicles are balanced. Various factors encountered when driving can cause them to become unbalanced, which results in vibration of the steering wheel.

The wheel must be rebalanced if a new tyre is fitted or if a tyre is repaired.

Incorrect wheel alignment

Incorrect front or rear wheel alignment causes excessive tyre wear, frequently on one side, and also impairs vehicle safety. If tyre wear is very irregular, contact an Official Service.

Tyre damage

To avoid damage to tyres and wheels, only drive over kerbs or similar obstacles slowly and at a right angle if possible.

Check tyres and wheels regularly for damage (punctures, cracks, blisters, deformities, etc.). Remove any foreign objects embedded in outside of the treads.

Unusual vibration or the car pulling to one side may indicate that one of the tyres is damaged. **Reduce speed immediately and stop if you suspect that a wheel may have been damaged!** Check the tyres for damage (blisters, cracks, etc.). If no external damage is visible, drive slowly and carefully to the nearest Official Service and have the vehicle inspected.

Low profile tyres

Low profile tyres, compared to other rim and tyre combinations, offer a broader tread and a greater rim diameter along with a lower height of the tyre sidewall. This results in a more agile driving behaviour. However, on roads that are in poor condition, this might affect comfort and cause more noise.

Low profile tyres may deteriorate more quickly than standard tyres, for instance due to strong knocks, potholes, manhole covers and kerbs. Therefore, maintaining the correct tyre pressure is particularly important »» page 257.

To avoid damage to tyres and wheels, drive with special care when driving on roads in poor condition.

Visually inspect your tyres every 3,000 km regarding damage, e.g. flattening/cracks on the tyre sidewall or deformations/cracks on the rims. »

If the rims and tyres have received a heavy impact or have been damaged, have them checked and, if required, replaced at a specialised workshop.

Low profile tyres may deteriorate more quickly than standard tyres.

Interchanging tyres

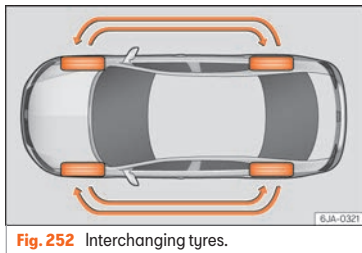

Fig. 252 Interchanging tyres.

Changing wheels around

If the wear is visibly greater on the front tyres, they should be exchanged for the rear tyres as shown in the diagram »» Fig. 252. All the tyres will then last for about the same time.

To ensure that the wear is equal on all tyres and maintain their optimum useful life, they should be changed around every 10,000 km.

Storing tyres

When you remove the tyres, mark them in order to maintain the same direction of rotation when they are installed again.

When removed, the wheels and/or tyres should be stored in a cool, dry and preferably dark location. Store tyres in a vertical position, if they are not fitted on wheel rims.

New tyres or wheels

All four wheels must be fitted only with tyres of the same type, size and the same tread pattern.

The correct tyre/wheel combinations specified for your vehicle are listed in its documentation.

Understanding the tyre designations makes it easier to choose the correct tyres. The tyre designation is marked on the sidewall. For example:

195/55 R 15 85 H

This contains the following information:

195	Tyre width in mm
55	Height/width ratio in %
R	identifying tyre construction letter - Radial
15	Rim diameter in inches
85	Load rating code
H	Speed rating code letter

The tyres are subject to the following **maximum speed limits**:

Speed rating code letter	Maximum speed limit
Q	160 km/h [99 mph]
R	170 km/h [106 mph]
S	180 km/h [112 mph]
T	190 km/h [118 mph]
U	200 km/h [124 mph]
H	210 km/h [130 mph]
V	240 km/h [149 mph]
W	270 km/h [168 mph]

The **manufacturing date** is also indicated on the tyre sidewall (possibly only on the outer side of the wheel).

DOT ... 27 16...

means, for example, that the tyre was produced in the 27th week of 2016.

Follow the instructions » page 259 if you only have a temporary spare wheel.

Note

A SEAT Service Centre should be consulted to find out whether wheels or tyres of different sizes to those originally fitted by SEAT can be fitted, and to find out about the combinations allowed between the front axle (axle 1) and the rear axle (axle 2).

Tyres with directional tread pattern

The direction of rotation is indicated by the **arrows on the tyre sidewall**. The direction of rotation indicated must be respected. This guarantees optimum grip and helps avoid excessive noise, wear and aquaplaning.

In the event of a flat tyre, a spare wheel with an undetermined tread pattern or an opposite tread pattern must be used and you must drive carefully, as in these cases the tyres no longer offer maximum performance.

Spare wheel

Spare wheel location*



Fig. 253 Boot: spare wheel.

The spare wheel is housed in a well under the floor panel in the luggage compartment and is secured by a special bolt » Fig. 253.

Take out the tool box before removing the spare wheel.

The tyre pressure of the spare wheel must be checked (preferably whenever the tyre pressure is checked – see sticker on fuel tank flap » page 256) to ensure the spare wheel remains ready for use.

If the spare wheel is not the same size or design as the tyres that are mounted on the car (for example if the car has winter tyres or tyres with direction tread), only use the spare tyre for a short period of time in the event of

breakdown and drive with the corresponding care » ⚠.

It must be replaced as soon as possible for a wheel with a normal size and finish.

Temporary spare wheel

If the vehicle is equipped with a temporary spare wheel, there will be a warning sign on the rim of the wheel.

Follow the instructions below when driving with this wheel fitted.

- After fitting the wheel, the warning sign must not be covered.
- Do not drive faster than 80 km/h (50 mph) with the spare wheel and take great care while driving. Avoid heavy acceleration, hard braking and fast cornering.
- The tyre pressure is the same as that of the standard tyres.
- Only use this spare wheel to reach the nearest Official Service, as it is not designed for permanent use.

⚠ WARNING

- **Under no circumstances must damaged spare wheels be used.**
- **If the spare wheel is different in size or design to the tyres currently fitted, never drive faster than 80 km/h (50 mph). Avoid heavy acceleration, hard braking and fast cornering.**

»

ⓘ CAUTION

Follow the instructions given on the temporary spare wheel label.

ⓘ Note

The tyre pressure of the spare wheel must always correspond to the highest pressure prescribed for the model of vehicle in question.

Tyre monitoring system

Control lamp

(L) It lights up

The tyre pressure of a wheel is much lower than the value set by the driver » **⚠**.

(L) Flashes

Fault in the tyre pressure gauge. Contact a specialised service to have it fixed.

⚠ WARNING

• If the warning lamp (L) lights up, slow down immediately and avoid any severe braking or steering manoeuvres. Stop and check the tyres and their pressure as soon as possible.

• Under certain conditions (e.g. sporty driving style, driving on loose surfaces or in winter) the warning lamp (L) may take a while to light up or may remain switched off.

ⓘ Note

If the battery is disconnected the warning lamp (L) lights up when the ignition is switched on. This warning lamp must switch off after covering a short distance.

Tyre pressure*

The tyre pressure monitoring system uses ABS sensors to compare the revolutions and the circumference of each wheel. Should the circumference of any wheel change, the warning lamp (L) on the general instrument panel will light up and an audible warning will be heard.

Tyre circumference may change if:

- Tyre pressure is too low
- Tyre structure is damaged
- Vehicle load not evenly distributed
- wheels on one axle are subjected to greater load, (e.g. driving with trailer, uphill, downhill);
- Snow chains are fitted
- The temporary spare wheel is fitted

- One wheel on the axle has been changed

Basic system settings

Should the tyre pressure change or if one or more wheels are changed or the position of the wheel on the vehicle is changed, e.g. changing round the front and rear wheels, or where a warning lamp lights up when driving, the system must be adjusted as follows:

- Inflate all tyres to the prescribed pressures » page 256.
- Switch the ignition on.
- Store the new tyre pressure in the Easy Connect system with the (CAR) button and the (SETTINGS) function button » **📖** page 24.

• In vehicles without a radio: press and hold down the (L)SET button, with the ignition on, until an acoustic signal is heard.

⚠ WARNING

Despite the tyre pressure monitoring system, the driver remains responsible for maintaining the correct tyre pressure. You must therefore check the tyre pressure often.

ⓘ Note

• The tyre pressure monitoring system is not a replacement for regularly checking the tyre pressure, as it is unable to recognise an even drop in pressure.

- The tyre pressure monitoring system is unable to warn of a sudden drop in tyre pressure, e.g. a puncture. In this case, try to stop the vehicle carefully with no severe braking or steering manoeuvres.
- To ensure the tyre pressure monitoring system works correctly, the basic setting must be performed every 10 000 km (6000 miles) or once a year.

will not be exceeded, even if the maximum speed limit for the vehicle is higher.



For the sake of the environment

Summer tyres should be fitted again in time, as they give better handling on roads free of snow and ice and at temperatures over +7°C (+45°F). Summer tyres have a shorter braking distance, produce less rolling noise and do not wear as quickly. They also reduce fuel consumption.

Winter service

Winter tyres

Winter tyres will significantly improve handling of the vehicle in winter road conditions. The design of summer tyres (width, rubber compound, tread pattern) gives less grip at temperatures below +7°C (+45°F), on ice and snow. This applies particularly to vehicles equipped with **wide section tyres** or **high speed tyres** (code letters H or V on the sidewall).

In order to preserve the performance of the vehicle as much as possible, winter tyres must be fitted on all four wheels, the minimum depth of the tread must be 4 mm and the maximum age must be 4 years.

You can use winter tyres of a lower speed rating if the maximum speed limit of these tyres

Maintenance

Service

Service intervals

Servicing and Digital Maintenance Plan

Log of services performed (“Digital Maintenance Plan”)

The SEAT dealership or a specialised workshop records Service receipts in a central system. Thanks to this comprehensive documentation of the service history, it is possible to reproduce the services performed any time. SEAT recommends requesting a Service receipt after every service carried out containing all the services carried out on the system.

Whenever there is a new service the receipt is replaced with a current one.

The Digital Maintenance Plan is not available in some markets. In this case, your SEAT dealer will inform you about the current documentation of the work.

Service works

In the Digital Maintenance Plan, your SEAT authorised service or specialised workshop documents the following information:

- When each one of the services was carried out.
- Whether a specific repair has been suggested, e.g. changing the brake pads in the near future.
- If you have expressed a special request for the maintenance. Your Service Advisor will write the work order.
- The components or fluids that were changed.
- The date of the next service.

The Long Life Mobility Warranty is valid until the next inspection. This information is documented in all checks performed.

The type and the volume of the service may vary from one vehicle to another. A specialised workshop will be able to provide specific information on the jobs for your vehicle.

WARNING

If the services are insufficient or not performed and if the service intervals are not observed, the vehicle may be immobilised in traffic cause an accident and severe injuries.

- **Make sure that any repairs are carried out by a SEAT authorised service or specialised workshop.**

CAUTION

SEAT cannot be held liable for any damage to the vehicle due to insufficient work or of lack of availability of spare parts.

Note

Regular services on the vehicle not only maintain its value, but also its correct operation and road safety. For this reason, conduct the services in accordance with SEAT guidelines.

Fixed Service or Flexible Service

Services are classified as **oil change service** and **inspection**. The service interval display on the instrument panel display serves as a reminder of the next service.

Depending on the features, the engine and the conditions of use of the car, either the **Fixed service** or the **Flexible service** will be applied for an oil change service..

How to know which type of service needs to his vehicle

- Check the tables below:

Oil change service ^{a)}		
PR No.	Type of service	Service interval
Q11	Fixed	Every 5000 km or after 1 year^{b)}
Q12		Every 7500 km or after 1 year^{b)}
Q13		Every 10000 km or after 1 year^{b)}
Q14		Every 15000 km or after 1 year^{b)}
Q16	Flexible	According to the service interval display

^{a)} The data are based on normal conditions of use.

^{b)} Whatever happens first.

Inspection Service^{a)}

According to the service interval display

^{a)} The data are based on normal conditions of use.

Bear in mind the information about the specifications of the engine oil according to the VW standard »  page 42.

Particular characteristics of the Flexible Service



Regarding the **Flexible Service**, the oil change service only has to be performed when the vehicle needs it. To calculate when

you have to carry out this service, take into account the individual conditions of use and personal driving style. A major component of the flexible service is the use of LongLife oil instead of conventional engine oil.

Bear in mind the information about the specifications of the engine oil according to the VW standard »  page 42.

If you do not want to the flexible service you can select the fixed service. However, a fixed service may affect service costs. The Service Advisor will gladly advise you.

Service intervals display

At SEAT, the dates of the services are indicated by the service interval display on the instrument panel »  page 33 or in the **Vehicle settings** menu of the infotainment system »  page 24. The service interval display gives information for service dates that involve an engine oil change or an inspection. When the time for the corresponding service comes, additional work required, such as the change of brake fluid and the spark plugs, can be carried out.

Information on the conditions of use

The service intervals and groups are usually based on **normal conditions of use**.

If, on the other hand, the vehicle is under **adverse conditions of use**, some of the work must be carried out before the next service period or even between service intervals.

Conditions of use adverse include:

- The use of fuel with a high sulphur content.
- Frequent short trips.
- Letting the engine idle for a long period of time, as in the case of taxis.
- Using the vehicle in areas with thick dust.
- Frequent driving with a trailer (depending on equipment).
- Using the vehicle mostly in situations with a lot of traffic and stops (e.g. in a city).
- Using the vehicle mostly in winter.

This applies especially for the following parts (depending on equipment):

- Dust and pollen filter
- Air Care allergen filter
- Air filter
- Toothed chain
- Particulate filter
- Engine oil

The Service Advisor of your specialised workshop will gladly inform you about the need of performing service work between »

normal service intervals, always considering the conditions of use of your vehicle.

WARNING

If the services are insufficient or not performed and if the service intervals are not observed, the vehicle may be immobilised in traffic and cause accidents and severe injuries.

- Have the services conducted at authorised SEAT services or specialised workshops.

CAUTION

SEAT cannot be held liable for any damage to the vehicle due to insufficient work or of lack of availability of spare parts.

Sets of services

Sets of services include all the **maintenance works** needed to ensure the safety and the smooth running of the vehicle (**depending on the conditions of use and the features of the vehicle**, such as the engine, gearbox, or operating fluids). Maintenance services are divided into *inspection* and *review* services. Consult the details of the jobs required for your vehicle at:

- Your SEAT authorised service
- Your specialised workshop

Due to technical reasons (continuous development of components) the sets of services may vary. Your SEAT authorised service or specialised workshop is always receiving updates in time.

Additional service offers

Approved spare parts

Original SEAT Spare Parts have been conceived for their vehicles and approved by SEAT, with a special emphasis on safety. These parts correspond exactly to the manufacturer's requirements in terms of design, accuracy of the measurements and materials. The original SEAT Spare Parts have been conceived exclusively for your vehicle. For this reason, we always recommend the use of Original SEAT Spare Parts. SEAT cannot be held liable for the safety and suitability of parts from other manufacturers.

Approved spare parts

Approved spare parts, following the manufacturer's requirements, are an additional service to you, offering the possibility of replacing complete sets, such as: light engine, gearboxes, heads, control units, electrical components, etc.

These parts are, **approved parts**, and are the same as the factory parts, which are also approved spare parts.

Original accessories

We recommend you only use SEAT Original Accessories and SEAT approved accessories for your vehicle. The reliability, safety and suitability of these accessories have been inspected specifically for this type of vehicle. SEAT cannot be held liable for the safety and suitability of parts from other manufacturers.

SEAT Service Mobility (SEAT Service Mobility)

Since the moment you purchase your SEAT vehicle you will be able to enjoy the benefits and coverage of the SEAT Mobility Service.

For the first two years after the purchase, your new SEAT vehicle is automatically covered by the SEAT Mobility Service without additional costs.

If you wish to enjoy this service after this period, you can extend SEAT Mobility as long as you carry out the recommended Inspection and Maintenance Services at a SEAT Authorised Service.

If your SEAT vehicle is immobilised due to a fault or an accident, our assistance services will help you keep moving.

Take into account that the SEAT Mobility Service differs depending on the country in which the vehicle was purchased. For further information ask your SEAT dealership or the SEAT website in your country.

Warranty

Fault-free operation warranty

SEAT Authorised Services ensure the perfect condition of new vehicles. Check the purchase agreement or complementary additional documentation provided by your Technical Service to see the conditions and the terms of the warranty. Consult further information in this regard in your SEAT Official Service.

Vehicle maintenance

Maintenance and cleaning

Basic considerations

Regular and careful care helps to maintain the value of your vehicle. In addition, it may become a prerequisite to demand the warranty in the event of corrosion damage and deficiencies in the paint coat of the body-work.

Specialised workshops have the necessary care products. Please follow the instructions for application on the packaging.

WARNING

- **Cleaning products and other materials used for car care can be damaging to your health if misused.**
- **Always keep care products in a safe place, out of the reach of children. Danger of poisoning!**

For the sake of the environment

- **When purchasing car care products, chose products that are compatible with the environment.**
- **The waste from car-care products should not be disposed of with ordinary household waste.**

Washing the vehicle

The longer you take to clean the tanks, e.g. remains of insects, bird excrements, tree resin or anti frost salt adhered to your vehicle, the more damage it can cause to the surface. High temperatures, for instance strong sunlight, further intensify the damage.

Before washing the car, soften the dirt using plenty of water.

To remove encrusted dirt such as insects, bird droppings or tree resin, use a lot of water and a microfibre cloth.

Have the underside of the vehicle washed after the end of the anti frost salts in winter.

High pressure cleaners

When washing the vehicle with a high-pressure cleaner, always follow the operating instructions for the equipment. This applies particularly to the operating pressure and the distance between the spraying water. Do not aim the jet directly to the side window gaskets, doors, covers or the panoramic sunroof*; the same applies to tyres, rubber hoses, soundproofing material, sensors* or camera lenses*. Keep a distance of at least 40 cm.

Do not remove snow and ice with a high-pressure cleaner.



Do not use a nozzle that sprays the water out in a direct stream or one that has a rotating jet for forcing off dirt.

The water temperature must not exceed 60°C.

Automatic car wash tunnels

Spray the vehicle before starting the car wash.

Make sure that the windows and the panoramic sunroof* are closed and the windscreen wipers are deactivated. Bear in mind the instructions of the car wash tunnel operator, especially if your vehicle has detachable parts.

Use of car washes without brushes if possible.

Washing by hand

Clean your vehicle from top to bottom with a soft sponge or with a brush. Only use cleaning products that do not contain solvents.

Washing vehicles with a matte paint by hand

To prevent damage to the vehicle when washing it, first remove the thicker dust and dirt. To remove traces of insects, grease and fingerprints, it is best to use a special cleaner for matte paint.

Apply the product with a microfibre cloth. To avoid damaging the surface of the paint, do not apply too much pressure.

Rinse with plenty of water. Then clean it with a neutral cleaning product and a soft microfibre cloth.

Rinse the vehicle again with plenty of water and then leave it to dry. Remove traces of water with a leather cloth.

WARNING

- Only wash the vehicle with the ignition switched off or according to the specifications of the car wash tunnel operator. Risk of accident!
- When cleaning the underbody or the inside of the wheel arches, protect yourself from sharp or pointy metal parts. Risk of cut!
- After cleaning the brakes could act more slowly due to moisture or, in winter, the ice on the brake discs and pads. Risk of accident! In this case the brakes should be dried by pressing the brake pedal several times.

CAUTION

- Before washing the vehicle in an automatic car wash, please make sure to retract the exterior mirrors to prevent them from being damaged. Electric exterior rear-

view mirrors must always be folded/deployed electrically!

- Do not wash the vehicle in direct sunlight. Risk of damaging the paint job!
- Do not use sponges, abrasive household sponges or similar to clean insect remains. Risk of damaging the surface!
- Vehicle parts with matte paint:
 - Do not use polish or hard wax. Risk of damaging the surface!
 - Never select washing programs that include the use of wax. This could damage the appearance of matte paint.
 - Do not put stickers or magnets on parts with matte paint, as removing them may damage the paint.

For the sake of the environment

The car should only be washed in special wash bays. These places are prepared to prevent oily water from getting into the public drains.

Cleaning and maintenance instructions

The cleaning and maintenance of individual components of the vehicle can be checked in the following tables. The contents should be understood merely as a recommendation. Go to your specialised workshop if you have

special questions or parts that are not listed. Take the general considerations into account »» **△** in **Take special care with...** on page 270.

Exterior cleaning

Windscreen wipers

Problem	Solution
Dirt	Soft cloth with wipers

Headlights / Tail lights

Problem	Solution
Dirt	Soft sponge with neutral soap solution ^{a1}

^{a1} Neutral soap solution: two tablespoons maximum in 1 litre of water

Sensors / Camera lenses

Problem	Solution
Dirt	<i>Sensors</i> : soft cloth with cleaning product which does not contain solvents <i>Camera lenses</i> - soft cloth with cleaning product with no alcohol content
Snow/ice	Hand brush/Anti frost spray with no solvents

Wheels

Problem	Solution
Anti frost salt	Water
Brake abrasion dust	Acid-free special cleaning product

End exhausts

Problem	Solution
Anti frost salt	Water, if a steel cleaning product is required

Covers / Trims

Problem	Solution
Dirt	Neutral soap solution ^{a1} , if a steel cleaning product is required

^{a1} Neutral soap solution: two tablespoons maximum in 1 litre of water

Paint

Problem	Solution
Flaws in the paint	Check the paint's colour code in an authorised service and restore with a touch-up pencil
Spilled fuel	Immediately rinse with water
Environmental rust tank	Apply rust remover and then apply hard wax. Go to your specialised workshop if you have any queries

Problem	Solution
Corrosion	Have your specialised workshop take care of this
The water does not create droplets on the clean paint	Maintain with hard wax (at least 2 times a year)
No shine despite sober maintenance/paint	Treat with suitable wax and apply paint preservative afterwards if the wax used does not contain preservative ingredients
Tanks, e.g. insect remains, bird droppings, tree sap, road salt	Immediately soften with water and remove with a microfibre cloth
Fat-based dirt, e.g. cosmetic products or sunscreen	Delete immediately with a neutral soap solution ^{a1} and a soft cloth

^{a1} Neutral soap solution: two tablespoons maximum in 1 litre of water

Carbon fibre parts

Problem	Solution
Dirt	Clean the same way as painted parts »» page 265

»

Decoration slides

Problem	Solution
Dirt	Soft sponge with neutral soap solution ^{a1}

^{a1} Neutral soap solution: two tablespoons maximum in 1 litre of water

Interior cleaning

Windows

Problem	Solution
Dirt	Apply windscreen cleaner and then dry with a cloth

Covers / Trims

Problem	Solution
Dirt	Neutral soap solution ^{a1}

^{a1} Neutral soap solution: two tablespoons maximum in 1 litre of water

Plastic parts

Problem	Solution
Dirt	Damp cloth
Encrusted dirt	Neutral soap solution ^{a1} , if possible solvent-free plastic cleaner

^{a1} Neutral soap solution: two tablespoons maximum in 1 litre of water

Displays/instrument panel

Problem	Solution
Dirt	Soft cloth with a liquid crystal display cleaner

Control panels

Problem	Solution
Dirt	Soft brush, then soft cloth with neutral soap solution ^{a1}

^{a1} Neutral soap solution: two tablespoons maximum in 1 litre of water

Seat belts

Problem	Solution
Dirt	Neutral soap solution ^{a1} , allowed to dry before retracting

^{a1} Neutral soap solution: two tablespoons maximum in 1 litre of water

Fabrics, artificial, Alcantara leather

Problem	Solution
Dirt particles adhered to the surface	Vacuum cleaner
Water-based dirt, e.g. coffee, tea, blood etc.	Absorbent cloth and neutral soap solution ^{a1}

Problem	Solution
Grease-based dirt, e.g. oil, make-up, etc.	Apply a neutral soap solution ^{a1} . Absorb the dissolved grease and paint particles drying with an absorbent cloth, in case you must treat it with water afterwards
Special dirt, e.g. pens, nail polish, dispersion paint, shoe cream etc.	Special stain remove: dry with an absorbent cloth, if applicable, apply neutral soap solution afterwards ^{a1}

^{a1} Neutral soap solution: two tablespoons maximum in 1 litre of water

Natural leather

Problem	Solution
Recent dirt	Cotton cloth with neutral soap solution ^{a1}
Water-based dirt, e.g. coffee, tea, blood etc.	Recent stains: absorbent cloth Dry stains: leather cleaner
Grease-based dirt, e.g. oil, make-up, etc.	Recent stains: absorbent cloth and leather cleaner Dry stains: grease dissolving spray
Special dirt, e.g. pens, nail polish, dispersion paint, shoe cream etc.	Stain remover suitable for leather

Problem	Solution
Care	Apply preservative cream regularly to protect from sunlight. Use a colour preservative if required

^{a1} Neutral soap solution: two tablespoons maximum in 1 litre of water

Carbon fibre parts

Problem	Solution
Dirt	Clean like plastic parts

Take special care with...

Headlights/tail lights

- Do not clean the headlights/tail lights with a dry cloth or sponge.
- Do not use cleaning products that contain alcohol. Risk of cracks!

Wheels

- Do not use for paint wax or other abrasive products.
- If the protective coating on the paint of the rim has been damaged due to stone impacts, scratches, etc., the damage should be repaired immediately.

Camera lenses

- Do not use hot or warm water to remove ice or snow from the camera lenses. Risk of cracking the lens!
- To clean the camera lens, never use abrasive cleaning products or products with alcohol. Risk of scratches and cracks!

Windows

- Remove snow and ice from windows and exterior mirrors with a plastic scraper only. To avoid scratches, the scraper should only be pushed in one direction and not moved to and fro.
- Never remove snow or ice from windows and rearview mirrors with warm or hot water. Risk of cracks on the windows!
- To prevent damage to the heating of the rear window, do not put stickers over the heating elements.

Covers/trims

- Do not use cleaning products or chrome based cleaning agents.

Paint

- The vehicle must be free from dirt and dust before applying wax or care products. Risk of scratches!
- Do not apply wax or care products if the vehicle is exposed to direct sunlight. Risk of damaging the paint job!

- The ambient rust deposits must not be removed through friction. Risk of damaging the paint job!
- Remove cosmetic products and sunlight immediately. Risk of damaging the paint job!

Displays/instrument panel

- The screens, the instrument panel and the trim around it must not be cleaned dry. Risk of scratches!
- Make sure that the instrument panel is switched off and cooled down before cleaning.
- Make sure that no liquid leaks between the instrument panel and the trim. Risk of damage!

Control panels

- Make sure that no liquid leaks into the control panels. Risk of damage!

Seat belts

- Do not remove the seat belts to clean them.
- Seat belts and their components must never be cleaned with chemical products, nor should they be allowed to come into contact with corrosive liquids, solvents or sharp objects. Risk of damaging the fabric!
- If you find any damage to the belt webbing, belt fittings, the belt retractor or the buckle, ask your specialised workshop to replace the belt in question.



Fabrics/artificial leather/Alcantara leather

- Do not treat artificial leather/Alcantara leather with leather cleaning products, solvents, wax polish, shoe cream, stain removers or similar products.
- If the stain is very hard to remove, take the vehicle to a specialised workshop to have it removed there. This will prevent damage.
- Do not use steam cleaners, brushes, hard sponges, etc. to clean.
- Do not turn on seat heating* to dry the seats.
- Sharp objects on clothing, such as zips, rivets or belts can damage the surface.
- Open Velcro, e.g. on clothes can damage the seat upholstery. Make sure that Velcro fasteners are closed.

Natural leather

- Never use solvents, wax polish, shoe cream, spot removers or similar products on leather.
- Sharp objects on clothing, such as zips, rivets or belts can damage the surface.
- Do not use steam cleaners, brushes, hard sponges, etc. to clean.
- Do not turn on seat heating* to dry the seats.
- Avoid exposing leather to direct sunlight for long periods, otherwise it may tend to lose some of its colour. If the car is left for a pro-

longed period in the bright sun, it is best to cover the leather.

WARNING

Do not use water-repellent coatings on the windscreen. In bad visibility conditions such as humid weather, darkness or when the sun is in its lowest point, visibility may be impacted. Risk of accident! Such coatings can also cause the windscreen wiper blades to make noise.

Note

- Remains of insects can be removed much more easily with previously treated paint.
- Regular car care treatments can prevent deposits of ambient rust.

Remove the vehicle from traffic

If you want to leave your vehicle stationary for a long period of time, contact a qualified workshop. They will gladly inform you about the necessary measures, such as anti-corrosion protection, Service and storage.

Also take into account instructions regarding the vehicle's battery »» page 251.

Information for the user

Information for the user

Important information

Recycling of electrical or electronic devices

All electrical or electronic devices (EED) that are not permanently fitted in the vehicle must be marked with the following symbol:



This symbol indicates that EED must not be discarded as home waste but through selective waste collection.

Information about the EU Directive 2014/53/EU

Simplified EU compliance declaration

Your vehicle has different radioelectrical devices. The manufacturers of these devices declare that they comply with Directive 2014/53/EU when legally required.

The full text of the EU compliance declaration is available online at the following address:

www.seat.com/generalinfo



Table of correspondences

The table of correspondences will help you to associate the name of the device in the declaration of compliance with the features of the vehicle and the terminology used in the on-board documentation.

Features of the vehicle	Name of the device according to the declaration of compliance
Radiofrequency remote control (vehicle)	FS09, FS12A, FS12P, FS1477, FS94
Radio frequency remote control (auxiliary heater)	Sender STH SEAT - 50000914 Telestart
Auxiliary heating	50000864 / D208L VW Telestart
Bluetooth	MIB2 Entry MIB Standard 2 MIB2 Main-Unit A580 / A270

Features of the vehicle	Name of the device according to the declaration of compliance
Wireless hotspot	MIB2 Main-Unit A580 / A270
Keyless Access System	MQB-B B
Radars sensors for assistance systems	ARS4-B MRRevo14F BSD3.0
Central control unit	5WK50254 5WK50474
Infotainment system	MIB2 Entry MIB Standard 2 MIB2 Main-Unit A580 / A270
Wireless charging	WCH-183 WCH-185 5G0.980.611
Connection to the external antenna of the car	UMTS/GSM-MMC UMTS/GSM-MMC-AG2



Features of the vehicle	Name of the device according to the declaration of compliance
Instrument panel	eNSF
	Immobilizer integrated in dashboard module instrument cluster
Antenna	FM/AM Antenna Base
	Antennas MQB27 Small/Big family
	Antennas KSA Small Fam III
	5Q0.035.507 Roof Antenna
	GNSS Antenna VAG 720166002
	8S7.035.503.B
Antenna amplifiers	6F0.035.225
	6F9.035.225
	3V5.035.577.A
	7N0.035.552.J
	7N0.035.552.K
	7N0.035.552.Q
	5F4.035.225
	5F4.035.225.A
	5F4.035.225.B
	5F9.035.225
	5F9.035.225.A
5F9.035.225.B	
575.035.225	
575.035.225.A	
575.035.225.B	

Addresses of the manufacturers

According to the Directive 2014/53/EU, all relevant components must include the address of the manufacturer.

The address of the manufacturers of components that, due to their size or nature, cannot include a sticker are listed below, as long as it is legally required:

Radioelectrical equipment fitted in the vehicle	Addresses of the manufacturers
Radiofrequency remote control key	Hella KGaA Hueck & Co. Rixbecker Straße 75 59552 Lippstadt, GERMANY
Radio frequency remote control (auxiliary heater)	Digades gmbH Äußere Weberstraße 20 02763 Zittau, GERMANY
	Webasto Thermo & Comfort SE Friedrichshafener Str. 9 82205 Gilching, GERMANY
Radar sensors for assistance systems	ADC Automotive Distance Control Systems GmbH Peter-Dornier-Straße 10 88131 Lindau, GERMANY
	Robert Bosch GmbH Postfach 16 61 71226 Leonberg, GERMANY

Frequency bands, station power

Radioelectrical equipment ^{a)}	Frequency band	Max. station power	Valid for models
Radiofrequency remote control (vehicle)	433.05-434.78 MHz	10 mW (ERP)	All SEAT models
	433.05-434.79 MHz	10 mW	
	868.0-868.6 MHz	25 mW	
	434.42 MHz	32 µW	
Radio frequency remote control (auxiliary heater)	868.7-869.2 MHz (869.0 MHz)	0.24 mW, / -6.3 dBm e.r.p.	Ateca
	868.0-868.6 MHz (868.3 MHz)	3.1 mW, / 4.8 dBm e.r.p.	Alhambra
Auxiliary heating	868.0-868.6 MHz (868.3 MHz)	23.5 mW, / 13.7 dBm e.r.p.	Alhambra
	868.7-869.2 MHz (869.0 MHz)	23.5 mW, / 13.7 dBm e.r.p.	Ateca
Bluetooth	2402-2480 MHz	6 dBm	All SEAT models
	2400-2483.5 MHz	10 dBm	
Wireless hotspot	2400-2483.5 MHz	10 dBm	Leon and Ateca
Connection to the external antenna of the car	GSM 900: 880-915 MHz	33 dBm	Ibiza, Arona, Leon, Ateca and Alhambra
	GSM 1800: 1710-1785 MHz	30 dBm	
	WCDMA FDD I: 1920-1980 MHz	24 dBm	
	WCDMA FDD III: 1710-1785 MHz	24 dBm	
Keyless Access	434.42 MHz	32 µW	Ibiza, Toledo, Arona, Leon and Ateca
Radar sensors for assistance systems	76 GHz-77 GHz	28.2 dBm	Toledo, Leon and Alhambra
		35.0 dBm	Ibiza, Arona and Ateca
	24050-24250 MHz	20 dBm	Arona, Ateca and Alhambra
Wireless charging	110-120 kHz	10 W	Ibiza, Arona, Leon and Ateca



Information for the user

Radioelectrical equipment ^{a)}	Frequency band	Max. station power	Valid for models
Instrument panel	125 kHz	40 dB μ A/m	All SEAT models

^{a)} The commissioning or authorisation of radioelectrical technology may be restricted in some European countries, forbidden or only allowed with additional requirements.

Technical data

Technical specifications

Important information

Important

The information in the vehicle documentation always takes precedence over the information in this Instruction Manual.

All technical specifications provided in this documentation are valid for the standard model in Spain.

The figures may be different depending whether additional equipment is fitted, for different models, for special vehicles and for other countries.

Abbreviations used in the Technical Specifications section

kW	Kilowatt, engine power measurement.
PS	Pferdestärke (horsepower), formerly used to denote engine power.
rpm	Revolutions per minute - engine speed.
Nm	Newton metres, unit of engine torque.
CZ	Cetane number, indication of the diesel combustion power.
RON	Research octane number, indication of the knock resistance of petrol.

Vehicle identification data



Fig. 254 Chassis number.

VIN in the Easy Connect

- Select: **CAR** button > function button **SETTINGS** > **Service** > **Chassis number**.

Chassis number

The VIN is located in the Easy Connect and under the windscreen, on the driver side » **Fig. 254**. Additionally, the chassis number is located in the engine compartment, on the right-hand side. The number is engraved on the top side rail, and is partially covered.

Type plate

The model plate is located at the bottom of the B pillar, between the front and rear doors, on the right-hand side.

The type plate indicates the following weights:

- Total permitted weight of the vehicle when loaded
- Maximum authorised weight of the vehicle with a trailer, when the vehicle operates as a tractor
- Maximum permitted load of the front axle
- Maximum permitted load of the rear axle

Weight in running order

The weight in running order only has one approximate value. This value corresponds to the minimum operative weight of the vehicle without additional equipment that increases its weight, i.e. air conditioning, spare wheel, towing bracket.

»

The running order weight also includes 75 kg of the weight of the driver and service fluids, in addition to a fuel tank at 90% capacity.

From the difference between the total permitted weight in running order the approximate carrying capacity can be calculated »» ⚠.

The carrying capacity must include:

- occupants,
- all pieces of equipment and other weights,
- roof loads including the roof rack,
- equipment that is not included in the running order weight,
- when using the towing bracket, the drawbar load (max. 50 kg).

Calculating fuel consumption and CO₂ emissions according to the ECE regulations and the EU specifications

Calculation of fuel consumption for urban driving begins when cold-starting the engine. Then, normal city driving is simulated.

In calculating extra-urban driving fuel consumption, braking and acceleration is done in all gears, as in daily use of the vehicle. Driving speed varies within a range of 0 and 120 km/h [75 mph].

The consumption value in combined driving is composed of 37% of the value of urban driving and 63% of the value of extra-urban driving.

⚠ WARNING

The maximum permitted weight values must not be exceeded – Risk of an accident and damage to the vehicle!

i Note

- If you wish to calculate the exact weight of your vehicle please contact a SEAT dealer.
- Depending on the volume of equipment, driving style, road conditions, weather conditions and the condition of the vehicle, consumption values can differ from the theoretical values stated here.

Information on fuel consumption

Fuel consumption

Approved consumption values are derived from measurements performed or supervised by certified EU laboratories, according to the legislation in force at the time (for more information, see the Publications Office of the European Union on the EUR-Lex website: © European Union, <http://eur-lex.europa.eu/>) and apply to the specified vehicle characteristics.

The values relating to fuel consumption and CO₂ emissions can be found in the documen-

tation provided to the purchaser of the vehicle at the time of purchase.

Fuel consumption and CO₂ emissions depend on the equipment/features of each individual vehicle, as well as on the driving style, road conditions, traffic conditions, environmental conditions, load or number of passengers.

i Note

In practice, and considering all the factors mentioned here, consumption values can differ from those calculated in the current European regulations.

Weights

Kerb weight refers to the basic model with a fuel tank filled to 90% capacity and without optional extras. The figure quoted includes 75 kg to allow for the weight of the driver.

Special versions, optional equipment fittings or retro-fitting accessories will increase the weight of the vehicle »» ⚠.

⚠ WARNING

- Please note that the centre of gravity may shift when transporting heavy objects; this may affect vehicle handling and lead to an accident. Always adjust your speed

and driving style to suit road conditions and requirements.

- Never exceed the gross axle weight rating or the gross vehicle weight rating. If the permissible axle load or the permissible total weight is exceeded, the driving characteristics of the vehicle may change, which could lead to accidents, injuries and damage to the vehicle.

Driving with a trailer

Trailer weights

Trailer weight

The trailer weights and drawbar loads approved are selected in intensive trials according to precisely defined criteria. The approved trailer weights are valid for vehicles in the EU for maximum speeds of 80 km/h (50 mph) [in certain circumstances up to 100 km/h (62 mph)]. The figures may be different in other countries. All data in the official vehicle documentation takes precedence over these data at all times »» ⚠.

Drawbar loads

The *maximum* permitted drawbar load on the ball coupling of the towing bracket must not exceed 50 kg.

In the interest of road safety, we recommend that you always tow approaching the maximum drawbar load. The response of the trailer on the road will be poor, if the drawbar load is too small.

If the maximum permissible drawbar load cannot be met (e.g. with small, empty and light-weight single axle trailers or tandem axle trailers with a wheelbase of less than 1 metre), a minimum of 4% of the actual trailer weight is legally required for the drawbar load.

⚠ WARNING

- For safety reasons, you should not drive at speeds above 80 km/h (50 mph) when towing a trailer. This also applies in countries where higher speeds are permitted.
- Never exceed the maximum trailer weights or the drawbar load. If the permissible axle load or the permissible total weight is exceeded, the driving characteristics of the vehicle may change, leading to accidents, injuries and damage to the vehicle.

Wheels

Tyre pressure, snow chains and wheel bolts

Tyre pressure

The sticker with the tyre pressure values can be found on the inside of the fuel tank flap. The tyre pressure values given there are for cold tyres. Do not reduce the slightly raised pressures of warm tyres »» ⚠.

The pressure for winter tyres is 0.2 bar (2.9 psi / 20 kPa) higher than that of summer tyres.

Snow chains

Snow chains may be fitted only to the *front* wheels.

Consult the section "wheels" of this manual.

Wheel bolts

After the wheels have been changed, the **tightening torque** of the wheel bolts should be checked as soon as possible with a torque wrench »» ⚠. The tightening torque for steel and alloy wheels is 120 Nm.

⚠ WARNING

- Check the tyre pressure at least once per month. Checking the tyre pressure is very important. If the tyre pressure is too high or »»

too low, there is an increased danger of accidents - particularly at high speeds.

- If the tightening torque of the wheel bolts is too low, they could loosen while the vehicle is in motion. Risk of accident! If the tightening torque is too high, the wheel bolts and threads can be damaged.

Note

We recommend that you ask your Technical Service for information about appropriate wheel, tyre and snow chain size.

Engine data

Petrol engines

	1.0 TSI Start-Stop		
Power output in kW (PS) at 1/min	70 (95)/5,000-5,500	81 (110)/5,000-5,500	
Maximum torque (Nm at 1/min)	160/1,500-3,500	200/2,000-3,500	
No. of cylinders/displacement (cm ³)	3/999	3/999	
Fuel	Super 95 / Normal 91 (with a slight power loss) ROZ		
Gearbox	manual	manual	DSG
Top speed (km/h)	189 (4)	204 (5)	206 (6)
Acceleration from 0-80 km/h (seconds)	7.3	6.7	6.8
Acceleration from 0-100 km/h (seconds)	11.1	9.9	10.2
Maximum authorised weight (kg)	1,630	1,650	1,675
Weight in running order (with driver) (kg)	1,170	1,190	1,215
Maximum authorised weight on front axle (kg)	^{a)}	^{a)}	^{a)}
Maximum authorised weight on rear axle (kg)	^{a)}	^{a)}	^{a)}
Maximum trailer weight without brakes (kg)	580	590	600
Weight of trailer with brakes on gradients up to 8% (kg)	1,100	1,200	1,100
Weight of trailer with brakes on gradients up to 12% (kg)	1,000	1,100	1,000

^{a)} Data not available as this edition goes to print.

Petrol engines

	1.4 TSI Start-Stop	1.4 TSI Ecomotive	1.6 MPI	
Power output in kW (PS) at 1/min	92 (125)/5,000-6,000	92 (125)/5,000-6,000	81 (110)/5,800	
Maximum torque (Nm at 1/min)	200/1,400-4,000	200/1,400-4,000	155/3,800-4,000	
No. of cylinders/displacement (cm ³)	4/1,395	4/1,395	4/1,598	
Fuel	Super 95 / Normal 91 (with a slight power loss) ROZ			
Gearbox	DSG	DSG	manual	automatic
Top speed (km/h)	208 (6)	208 (6)	191 (5)	191 (6)
Acceleration from 0-80 km/h (seconds)	6.3	6.4	6.7	7.7
Acceleration from 0-100 km/h (seconds)	9	9	10.3	11.5
Maximum authorised weight (kg)	1,696	1,687	1,635	1,675
Weight in running order (with driver) (kg)	1,236	1,227	1,175	1,215
Maximum authorised weight on front axle (kg)	880	880	820	860
Maximum authorised weight on rear axle (kg)	830	830	840	840
Maximum trailer weight without brakes (kg)	600	610	580	600
Weight of trailer with brakes on gradients up to 8% (kg)	1,200	1,200	1,100	1,100
Weight of trailer with brakes on gradients up to 12% (kg)	1,200	1,200	1,000	1,000

Vehicle data

Dimensions

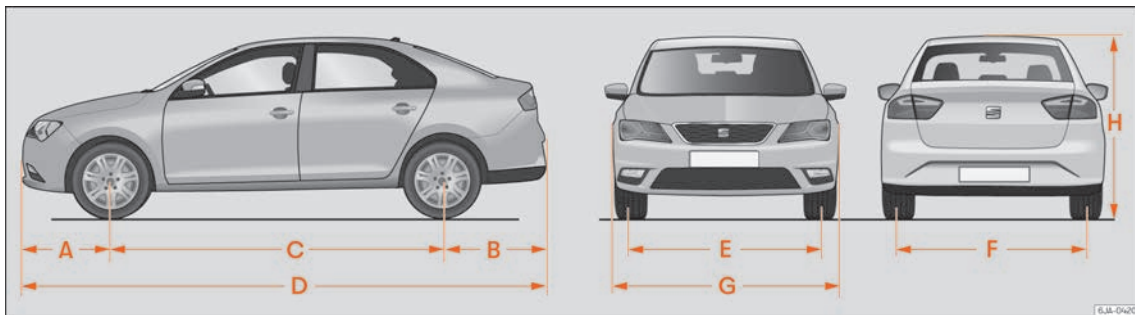

Fig. 255 Dimensions.

		TOLEDO
A/B	Front and rear projection (mm)	876/1,004
C	Wheelbase (mm)	2,602
D	Length (mm)	4,482
E/F	Front/rear ^{a1} track width (mm)	1,463/1,500
G	Width (mm)	1,715
H	Height at kerb weight (mm)	1,466
	Turning radius (m)	10.2

^{a1} This data will change depending on the type of wheel rim.

Index

A

- ABS
 control lamp 202
 see also Anti-lock brake system 201, 202
- Accessories 138, 240
- Adjust
 CAR menu 24
- Adjusting
 front head restraints 61
 seats 58
- Adjusting the head restraints
 front head restraints 132
- Adjustment
 front head restraints 132
 lights 121
 rear head restraints 62
- Airbag covers 16
- Airbags 68
- Airbag system 16, 68
 activation 70
 control lamp 73
 deactivation of front airbag 72, 73
 description 69
 front airbags 16, 70
 functioning 70
 head-protection airbags 18, 71
 side airbags 18, 71
- Air conditioning 37, 38
 air vents 147
 economic use 147
 faults 147
- introduction 146
 operation 149
- Alarm system 116
- Alcantara leather: cleaning 268
- Alternator
 warning lamp 253
- Ambient lighting 127
- Anchoring
 the front tow line 82
- Android Auto™ 167, 169
- Anti-block system 201
- Anti-freeze 43
- Anti-lock brake system 202
- Anti-puncture 47, 79
- Anti-puncture kit 47, 79
 check after 10 minutes 81
- Anti-slip regulation 202
- Anti-theft alarm 116
 vehicle interior monitoring and anti-tow
 protection 117
- Anti-theft security system 11
- Anti-theft system 112
- Anti-tow protection 117
- Apple CarPlay™ 167, 169
- Armrests
 front seats 133
 rear seats 134
- Ashtrays 138
- Aspects to note before setting off 57
- ASR
 control lamp 202
 see also Traction control system 201, 202
- Assistance systems
 ABS 202
 ASR 202
- cruise speed 217
- EDL 203
- emergency braking assistance (Front Assist) 219
- fatigue detection 230
- parking aid 222, 224
- Start-Stop 215
- tyre monitoring system 260
- Assisted starting 54
- Audible warning signal
 control and warning lamps 103
 unfastened safety belt 63
- Automatic air conditioning
 climatronic 151
- Automatic car wash tunnel 266
- Automatic dipped beam control 123
- Automatic gearbox
 driving programmes 207
 emergency program 207
 instructions for use 203
 kick-down 205
 manual release of the selector lever 36
 parking 204
 selector lever lock 206
 selector lever positions 205
 starting 204
 stopping 204
 tiptronic 203, 206
- Automatic transmission
 control lamp 204
- AUX-IN 195
 external audio source 176

- B**
- Back seat
 - folding down and raising the back seat backrest 134
 - Ball coupling
 - disassembly 238
 - Battery 110
 - Before setting off 57
 - Belt tightening 67
 - Biodiesel 244
 - Bluetooth®
 - connect audio source 176
 - Bonnet 244, 246
 - opening the bonnet 13
 - Brake assist 201
 - Brake fluid 43
 - checking 250
 - Brakes
 - brake fluid 250
 - control lamp 200
 - handbrake 200
 - running in 210
 - Brake servo 200
 - Braking
 - brake assist 201
 - Bulb failure
 - control lamp 120
- C**
- Capacities 41
 - Carrier system 145
 - Catalytic converter 213
 - malfunction 213
 - CCS 34, 217
 - Central locking 108
 - anti-theft alarm 116
 - central locking button 113
 - closing 112
 - individualised settings 111
 - keyless Access 113
 - locking 112
 - locking manually 12
 - opening 111
 - unlocking 111
 - Central locking system 110
 - Cetane number (diesel fuel) 244
 - Changing a wheel 48, 78
 - subsequent work 51
 - Changing bulbs 86
 - daytime driving light 89
 - dipped beam 88
 - double headlight bulbs 87
 - fog light 90
 - main beam headlight 88
 - side light 88
 - turn signal 89
 - Changing bulbs on the number plate 94
 - removing the bulb holder 94
 - Changing bulbs on the side panel 91
 - fitting the rear light 92
 - removing the bulb holder 91
 - removing the rear light 90
 - Changing lights on the side panel 90
 - Changing rear lights on the rear lid
 - changing bulbs 93
 - fitting the bulb-holder 93
 - removing the bulb holder 92
 - Charging the battery 54
 - Checking levels
 - engine compartment 246
 - Child-proof locking 116
 - electric windows 119
 - Child seat 19, 76
 - Child seats
 - categorisation into groups 76
 - ISOFIX system 20
 - safety instructions 19, 75
 - securing with the seat belt 19
 - Top Tether system 20
 - Cigarette lighter 137
 - Cleaning
 - Alcantara leather 268
 - carbon fibre 267, 269
 - control panels 268
 - decorative sheets 268
 - exhaust tail pipes 267
 - exterior 267
 - fabrics 268
 - headlights / tail lights 267
 - high pressure cleaners 265
 - Interior 268
 - leather 268
 - paint 267
 - plastic parts 268
 - seat belts 268
 - sensors/camera lenses 267
 - special care 269
 - the radio screen 268
 - trims/covers 267, 268
 - washing the vehicle 265
 - wheels 267
 - windows 268
 - windscreen wipers 267

- Climatronic 37
 - adjusting the temperature 152
 - air recirculation 152
 - automatic mode 152
 - blower selection 152
 - windscreen defrost 153
- Close 108
- Closing
 - central locking 112
 - vehicle with Keyless Access 113
 - windows 119
- Coat hooks 140
- Coming Home and Leaving Home 124
- Coming Home and Leaving Home Function .. 124
- Communication between the Infotainment system and mobile devices 163
- Compartments 135
- Connectivity 163
 - Full Link 163
- Control and warning lamps 34, 103
 - ABS 202
 - ABS anti-blocking system 201
 - airbags 73
 - alternator 253
 - ASR 201, 202
 - audible warning signal 103
 - blocking of the steering column 209
 - brakes 200
 - break recommendation 231
 - coolant 248
 - coolant temperature 101
 - cruise control system (CCS) 217
 - deactivating the airbag 17
 - depress the brake 219
 - diesel preheating system 213
 - disabling airbag 72
 - EDS 201
 - emission control 213
 - engine management 213
 - engine oil 247
 - ESC 201
 - fuel level 102
 - gearbox malfunctions 207
 - handbrake 201
 - instrument panel 34
 - lights 120
 - particulate filter 213
 - power steering 209
 - seat belt 63
 - Start-Stop 215
 - transmission 204
 - tyre pressure 260
 - tyres 260
 - windscreen washer fluid level 128
- Controls and displays
 - general instrument panel 97
- Controls for the windows 14, 119
- Controls on the steering wheel
 - without voice control 106
 - with voice control 104
- Coolant level
 - control lamp 248
- Coolant temperature
 - control lamp 248
- Cooling
 - coolant temperature gauge 101
- Cooling system
 - checking coolant 248
 - topping up coolant 248
- Correct position 58
- Correct sitting position
 - driver 58
 - front passenger 59
 - rear seat passengers 60
- Cruise control 34, 217
 - control and warning lamps 217
 - operation 217
 - temporary deactivation 218
 - turning off the cruise control system 218
- D**
- Damage to the vehicle 215
- Dash panel 34
- Data transfer 163
- Deactivating the front passenger front airbag . 17
- Deactivation of front airbag 72, 73
- Defective bulbs
 - changing bulbs 86
- Defrosting rear window 127
- Diesel
 - engine oil 247
 - particulate filter 214
 - Preheating 196
 - refuelling 244
- Diesel fuel
 - particulate filter 214
- Digital clock 100
- Dimensions 281
- Direction of rotation
 - tyres 51
- Display 98, 99
- Disposal
 - belt tensioners 68
 - Door cylinder 11
 - Door handle 11

- Door lock 11
 - Doors
 - child-proof locking 116
 - opening and closing 11
 - Drink holder
 - centre console 137
 - rear seat armrest 137
 - Driver
 - see Correct sitting position 58, 59, 60
 - Driver information system
 - operation through the windscreen wiper lever 27
 - Driving
 - driving abroad 125
 - economical 211
 - safe 57
 - Driving abroad
 - headlights 125
 - Driving data
 - data summary 29
 - memory 28
 - Driving through water 214
 - Driving with a trailer 232, 277
 - Dynamic headlight range control 121
- E**
- E10
 - see Ethanol (fuel) 244
 - Easy Connect 24
 - EDL
 - see Electronic differential lock 201, 203
 - Efficiency program
 - saving tips 32
 - Electric windows 14, 119
 - Electronic differential lock 201, 203
 - Electronic immobiliser 11
 - Electronic Stability Control (ESC) 201
 - Emergencies 78
 - automatic gearbox emergency program .. 207
 - bulbs 46
 - changing a wheel 48, 78
 - emergency towing of the vehicle 52
 - hazard warning lights 125
 - jump leads 54
 - puncture 46
 - replacing a blown fuse 45
 - Emergency
 - fuses 45
 - Emergency braking assistance system
 - indications on the display 219
 - malfunction 220
 - operating 221
 - radar sensor 220
 - switching off temporarily 222
 - system limitations 222
 - Emergency operation
 - front passenger door 12
 - Selector lever 36
 - Emission control system
 - control lamp 213
 - Emissions data 276
 - Engine
 - assisted starting 54
 - preheating 196
 - run-in 210
 - Start-Stop System 215
 - starting 196
 - starting the engine 198
 - switching off the engine 199
 - Engine and ignition
 - starting the engine with Keyless Access ... 197
 - Engine breakdown
 - Control lamp 213
 - Engine compartment 244, 246
 - battery 251
 - brake fluid 250
 - coolant 248
 - engine oil 247, 248
 - opening the bonnet 13
 - safety notes 244
 - windscreen washer fluid 251
 - Engine coolant 43
 - checking level 248
 - G12 plus-plus 43
 - G13 43
 - specifications 43
 - topping up 249
 - Engine data 279
 - Engine identification letter 275
 - Engine management 213
 - control lamp 213
 - Engine oil 42, 247
 - changing 247, 248
 - checking oil level 248
 - consumption 248
 - dipstick 248
 - inspection service 247
 - maintenance intervals 247
 - oil properties 42
 - specifications 247
 - topping up 248
 - Engine oil pressure
 - control lamp 247

- Environment
 ecological driving 211
 environmental compatibility 210
- Environmental tips
 refuelling 241
- Equipment 138, 240
- ESC
 electronic stability control 201
- Ethanol (fuel) 244
- Exhaust filtering system
 catalytic converter 213
 particulate filter 214
- Extending
 the luggage compartment 134
- Exterior lighting
 changing bulbs 86
- Exterior mirrors
 adjustment 15
 exterior 130
 heated 130
- Exterior view 7, 8
- External aerial 241
- F**
- Fabrics: cleaning 268
- Fastening rings 141
- Fatigue detection 230
- Filling up the tank 241
- Fire extinguisher 78
- First-aid kit 78
- Floor mats 62
- Fluid level control 41
- Fog
 lights with cornering light function 124
 Fog light bulb 90
- Fog lights with cornering light function 124
- Frequency band
 AM 171
 change 171
 DAB 171
 FM 171
- Front airbags 16, 70
- Front Assist
 indications on the display 219
- Front passenger front airbag
 control lamp 73
 deactivating 17
 deactivation 73
- Front seats 131
 heating 132
 manual adjustment 14
- Fuel 41, 241
 diesel 244
 ethanol 244
 fuel level gauge 102
 identification 242
 petrol 243
 refuelling 241
 saving 211
- Fuel consumption
 engine cut-off due to inertia 211
 Why does fuel consumption increase? 213
- Fuel tank flap
 opening and closing 41
- Full-LED Headlights 86
- Full Link 163
 pairing 167
 setup 167
- Function buttons 159
- Fuses 83
 identifying blown fuses 45
 identifying by colours 45
 in the dash panel 84
 in the engine compartment 85
 in the instrument panel 45
 preparation before replacing 45
 replacing 45
- G**
- Gauge
 fuel level 102
- Gear-change indicator 208
- Gearbox lever 36
- Gear change 36
 automatic 36
 engaging the gears (manual gearbox) 203
 manual 36
 manual gearbox 203
- Gear engaged 36
- Gear recommendation 208
- General instrument panel
 control and warning lamps 34
 controls and displays 97
- GRA
 see Cruise control 217
- H**
- Handbrake 199, 200
 control lamp 201
- Hazard warning lights 22, 125
- HBA 201
- Head-on collisions and their laws of physics 65

- Head-protection airbags
 - description 18
 - safety instructions 71
- Headlight range control 121
- Headlights
 - driving abroad 125
 - Headlight washers 130
- Head restraints 14
 - adjustment 132
 - front head restraints 61
 - rear head restraints 62
- Headrests 14
 - adjustment 132
 - front 61
- Heated rear window 127
- Heating 148
 - air recirculation 148
 - introduction 146
 - rear window 127
- Heating and fresh air 39
- HHC 201
- Hill hold control 201
- Horn 97
- How to jump start 54
 - description 54
- I**
- Identification of the fuel 242
- Ignition 20, 196, 197
- Ignition lock 20, 196, 197
- Immobiliser 197
- Incorrect position 60
- indications on the display
 - driver information system 27
- Indications on the display 99
 - assistance systems submenu 30
 - compass 100
 - distance travelled 99
 - doors, bonnet and rear lid open 31
 - driving data 28
 - ECO 100
 - Emergency braking assistance system (Front Assist) 219
 - identifying letters of the engine 100
 - recommended gear 100
 - second speed display 100
 - selector lever position 100, 205
 - service intervals 33
 - speed warning 100
 - Start-Stop 100
 - time 100
 - warning and information messages 32
- Indications on the screen
 - Outside temperature 100
- Infotainment knobs 158
- Infotainment system 24
 - CD player 175
 - function buttons 159
 - general instructions for use 158
 - general panel of the device 156
 - input mask 161
 - memory card 175
 - on-screen keypad 161
 - text input 161
 - update navigation data 179
- Infotainment System 154
 - AUX-IN 176
 - Bluetooth® audio 176
 - changing the volume 159
 - general panel 157
 - Images main menu 177
 - infotainment knobs 158
 - initial configuration 162
 - Media mode 172
 - memory buttons 172
 - mute 159
 - navigation 178
 - proximity sensors 162
 - Radio mode 171
 - rotary knobs 158
 - safety instructions 154
 - scroll knob 160
 - scroll (display) 160
 - search in lists 160
 - standby 158
 - station logos 172
 - switch on and off 158
 - Telephone mode 189
 - touchscreen 159
 - USB 175
 - Vehicle menu 188
 - verification boxes 159
- Inspection 247, 262
- Inspection service 247
- Instrument panel 98
 - control and warning lamps 103
 - display 98, 99
 - instruments 98
 - odometer 101
 - service interval indication 33
- Instruments 98
- Interference from a mobile telephone 158
- Interior
 - lighting 126

Interior lights	22
Interior view	
left-hand drive	9
steering wheel on the right	10
ISOFIX	20
ISOFIX system	20

J

Jack	48, 78
mounting points	50
Journey data	27
Jump leads	54

K

Key-operated switch	73
Keyless Access	
go	197
keyless-Entry	114
keyless-Exit	114
Keyless-Go	114
special characteristics	115
starter button	197
unlocking and locking the vehicle	113
Keyless Access lock and ignition system: see Keyless Access	113
Keys	
remote control	109
replacing the battery	110
unlocking and locking	11
vehicle key	109

L

Lever	
main beam headlights	122
turn signals	122
Lifting the vehicle	50
Lighting of the instrument panel	121
Lights	21, 120
AUTO	123
changing bulbs	86
coming home and Leaving Home	124
control and warning lamps	120
cornering light	124
daytime running lights	122
dipped beam	121
fog lights	124
glove box	127
hazard warning lights	22
headlight flasher	123
headlight range control	121
interior lights	126, 127
lighting of the controls	121
lighting of the instruments	121
light switch	120
luggage compartment	127
main beam headlights	122
main beams	21
parking lights	125
parking lights on both sides	125
rear fog light	124
rear interior light	126
side lights	121
switch	21
turn signals	122

Loading the vehicle	141
luggage compartment	12
Locking	
central locking	112
remote control	108
Locking and unlocking	
in the door cylinder	11
with Keyless Access	113
with the central locking button	113
Locking the front passenger door manually ...	12
Luggage compartment	12
automatic locking	118
category N1 vehicles	143
hook	143
light	127
manual release mechanism	12
opening and closing	117
retaining elements	143
retaining nets	143
shelf	144

M

Maintenance	
see Service	262
Maintenance intervals	247
Malfunction	
catalytic converter	213
emergency braking assistance system [Front Assist]	220
gearbox	207
particulate filter	214
Manual air conditioning	149
air recirculation	150
Manual gearbox	
gear lever	203

- Manual release mechanism
 rear lid 12
- Media
 changing the Media source 174
 copyright 173
 main menu 173
 messages and symbols 174
 playback sources 174
 playing modes 173
- Memory card 175
- Mirror
 vanity mirror 128
- MirrorLink 168
- Mobile 241
- Mobile telephones 241
- Model plate 275
- Multi-function display 27
- Multi-function steering wheel 103
- Multimedia 195
- Multimedia compartment 139
- N**
- Navigation 178
 change view 184
 entering the destination 180
 importing vCards 187
 main menu 180
 messages and symbols 180
 my destinations 182
 navigation announcements 181
 Navigation with images 188
 points of interest (POI) 184
 predictive navigation 187
 route 182
 select the destination on the map 181
 split screen 185
 traffic reports (TRAFFIC) 186
- Navigation announcements 181
- Number of seats 63
- O**
- Octane rating (petrol) 243
- Odometer 98, 101
 reset button 101
- Oil change 248
- Oil properties 42
- On-board computer
 see Driver information system 27
- Open and close 108
- Opening 108
 bonnet 13
 fuel tank flap 241
 vehicle, with Keyless Access 113
 windows 119
- Opening and closing 11
 bonnet 13
 central locking 111
 fuel tank flap 241
 in the door cylinder 11
 rear lid 12
 windows 119
 with the central locking button 113
- Original SEAT Spare Parts 264
- Outside temperature
 display 100
- P**
- Paint
 code 275
- Parking aid 222
 adjusting the display and audible warn-
 ings 227
 automatic activation 225
 malfunction 227
 operation 225
 parking aid plus 224
 rear parking aid 224
 sensors and camera: cleaning 267
 surrounds warning 224
 towing bracket 227
 visual indication 226
- Parking aid system
 see Parking aid 222, 224
- Parking distance warning system
 see Parking aid 222, 224
- ParkPilot
 see Parking aid 222, 224
- Particulate filter
 malfunction 214
- Parts 240
- Passenger
 see Correct sitting position 58, 59, 60
- Pedals 62
- Petrol
 Petrol 243
 preheating 196
- Positioning seat belts
 during pregnancy 66
 seat belts 66
- Power 138
- Power socket, 12 V 138
- Power socket, 5 V 138
- Power steering 209
 Control lamp 209

- Preheating 196
- Preheating system
control lamp 213
- Products for vehicle maintenance 265
- Puncture
action 46
- R**
- Radar sensor 220
- Radiator fan 246
- Radio
changing frequencies 171
information and symbols 171
main menu 171
memorise station logos 172
memory buttons 172
- Radio DISPLAY: clean 268
- Raising the vehicle 50
- Rear
headrests 62
- Rear Assist 227
instructions for use 228
parking 229
screen 228
special characteristics 229
- Rear Assist system 227
- Rear fog light
control lamp 120
- Rear lid 12, 117
see also Luggage compartment 118
- Rear seat passengers
see Correct sitting position 58, 59, 60
- Rear View Camera 227
- Rear view mirror
adjusting the exterior mirrors 130
anti-dazzle 130
interior anti-dazzle 130
- Rear window wiper blades
changing 56
cleaning 56
- refuelling
Petrol additives 243
- Refuelling 241
opening the fuel tank flap 241
- Remote control 108
synchronisation 109
- Repair work 240
- Replacement
parts 240
- Replacement parts 240
- Replacing the battery
of the vehicle key 110
- Reset the trip recorder 101
- Reverse gear (automatic gearbox) 205
- Revolution counter 98, 99
- Rims
changing a wheel 48
- Roll-back function
windows 119
- Roof carrier 145
attachment points 145
roof load 146
- Roof rack 145
- Rotary knobs 158
- Run-in
new engine 210
new tyres 255
the first 1,500 km 210
- Running in
brake pads 210
the tyres 210
- S**
- Safe 112
- Safety
child safety 75
child seats 75
deactivating the front passenger airbag 17
safe driving 57
- Safety equipment 57
- Safety instructions
belt tensioners 68
head-protection airbags 71
side airbags 71
use of seat belts 64
using child seats 19, 75
- Saving tips (efficiency program) 32
- Seat belt position
for pregnant women 15, 66
seat belts 15, 66
- Seat belt release 66
- Seat belts 63
adjustment 15, 66
control lamp 63
height adjustment 67
protective function 63
safety instructions 64
unfastened 65
- Seat belt tensioners 15, 67
- Seat heating 132
- SEAT Service Mobility 264
- Selector lever
positions 205

- Selector lever lock 206
- Selector lever (automatic gearbox)
malfunction 206
manual release mechanism 36
- Service
conditions of use 263
digital maintenance plan 262
fixed service 262
flexible service 262
oil change service 262
service 262
Service proof 262
services 262
servicing 262
sets of services 264
- Service interval indication 33
- Service intervals display 263
- Service warning: check 33
- Side airbags
description 18
safety instructions 71
see also Airbag system 18
- Signal lever 21
- Snow chains 52, 277
- Spanner symbol 33
- Spare wheel 259
- Special features
Lowering the volume 158
- Speed warning device 32
- Start-Stop
operation 215
- Start-Stop system 215
- Start-Stop System
driver instructions 215
lamps 215
- Starter button 197
- Starting the engine 196, 198
- Starting the vehicle 20
- Steering
control lamp 209
steering lock 196
- Steering wheel
adjustment 16, 59
- Storage compartment
passenger side 135
- Storage compartments 135
front seats 136
glasses 139
in front door 140
in the centre console 140
in the luggage compartment 140
reflective vest 136
- Sun visors 128
- Switch
hazard warning lights 125
Switch-off delay (Infotainment system) 158
Switching off the engine
with the key 199
Switching off the lights 120
Switching on the lights 120
Switching the ignition on and off 196
Switch on 196
- T**
- Tailgate locking time extension
see Luggage compartment 118
- Technical specifications 275
- Telephone
Bluetooth® profiles 190
call lists 194
- display and symbols 193
enter telephone number 194
general information 189
main menu 192
pairing a mobile phone 191
places with special regulations 190
- Temperature selection
heating 148
- Tightening torque of wheel bolts 277
- Timer 30
lap times 30
menu 30
statistics 30
- Tiptronic (automatic gearbox) 203, 206
- Top speed 32
- Top Tether 20
- Top Tether system 20
- Tow-starting 53
- Tow-starting the engine 81
- Towing bracket device 232
- Towing the vehicle 52, 81
- Towline anchorages 53
- Traction control 202
- Traction control system 201
- Trailer 232
ball coupling 236
correct placement 237
driving with a trailer 233
parking aid 227
service position 235
towing device 234
trailer weights 232
use and maintenance 239
- Trailer weight 277

- Transporting
 luggage compartment 142
- Transporting children 75
- Transporting items
 carrier system 145
 roof carrier 145
- Trip recorder 98
- Tyre Mobility Set 47
 components 80
 inflating a tyre 80
 sealing a tyre 80
- Tyre Mobility System
 see Anti-puncture kit 79
- Tyre monitoring system 260
- Tyre pressure 277
- Tyre pressure monitoring
 control lamp 260
- Tyre Profile 256
- Tyre repair 79
- Tyre repair kit
 see Anti-puncture kit 79
- Tyres
 changing 48
 dimensions 258
 interchanging 258
 new tyres 258
 pressure 260
 service life 256
 wear indicators 256
 with compulsory direction of rotation 51
 with directional tread pattern 259
- Tyre tread depth 256
- Tyre wear 256
- U**
 Unfasten the seat belt 15
- Unlocking
 central locking 111
 remote control 108
- Unlocking and locking 11
 with Keyless Access 113
 with the central locking button 113
- USB 195
 connecting an external data storage device 175
- USB/AUX-IN Port 195
- V**
 Vehicle
 chassis number 275
 identification data 275
 identification number 275
 raising 50
 unlocking and locking with Keyless Access 113
- Vehicle battery 44, 251
 assisted starting 54
 automatic disconnection of electrical equipment 255
 changing 255
 checking electrolyte level 253
 connecting and disconnecting 251
 disconnect and connect 34
 lifting the cover 253
 winter conditions 251
 winter service 254
- Vehicle care
 windscreen wipers service position 56
- Vehicle data 281
- Vehicle interior monitoring and anti-tow system
 Vehicle interior monitoring and anti-tow system 117
- Vehicle maintenance 265
- Vehicle paint
 maintenance 267
- Vehicle seats 63
- Vehicle tool kit 48, 78
- Ventilation slits 141
- W**
 Warning symbols
 see Control and warning lamps 103
- Warning triangle 78
- Warranty 265
- Washing the vehicle
 external vehicle maintenance 265
 high pressure cleaners 265
 special characteristics 115
- Weights 276
- Wheel bolts 277
 caps 49
 loosening and tightening 49
- Wheel cover 48
- Wheels 255, 277
 anti-theft wheel bolts 49
 chains 277
 changing 48, 51, 78
 new wheels 258
 snow chains 52
 spare wheel 259
 wheel bolts 79
 wheel cover 48

Wheel trim	
removing	49
Windows	
electric	14, 119
Window wiper blade	23
Windscreen washer	44
Headlight washers	130
Windscreen washer fluid	
checking	251
control lamp	128
winter	251
Windscreen washers	128
jets	129
Windscreen washer water	
checking	251
topping up	251
Windscreen wipers	23, 128
cleaning	267
control	129
lifting the wiper blade	56
replacing the wiper blade	56
service position	56
windscreen washer fluid	251
Winter conditions	
battery	251
diesel	244
snow chains	52
tyres	261
Winter service	
battery	254
disconnecting and connecting	254
Winter tyres	261
Wipe interval	129

SEAT S.A. is permanently concerned about continuous development of its types and models. For this reason we ask you to understand, that at any given time, changes regarding shape, equipment and technique may take place on the car delivered. For this reason no right at all may derive based on the data, drawings and descriptions in this current handbook.

All texts, illustrations and standards in this handbook are based on the status of information at the time of printing. Except for error or omission, the information included in the current handbook is valid as of the date of closing print.

Re-printing, copying or translating, whether total or partial is not allowed unless SEAT allows it in written form.

SEAT reserves all rights in accordance with the "Copyright" Act.

All rights on changes are reserved.

 This paper has been manufactured using bleached non-chlorine cellulose.

© SEAT S.A. - Reprint: 15.11.18

Inglés 6JA01Z720BL (11.18)



6JA01Z720BL

